

# Easy Access Rules for Aerodromes (Regulation (EU) No 139/2014)

## EASA eRules: aviation rules for the 21st century

Rules and regulations are the core of the European Union civil aviation system. The aim of the **EASA eRules** project is to make them **accessible** in an efficient and reliable way to stakeholders.

**EASA eRules** will be a comprehensive, single system for the drafting, sharing and storing of rules. It will be the single source for all aviation safety rules applicable to European airspace users. It will offer easy (online) access to all rules and regulations as well as new and innovative applications such as rulemaking process automation, stakeholder consultation, cross-referencing, and comparison with ICAO and third countries' standards.

To achieve these ambitious objectives, the **EASA eRules** project is structured in ten modules to cover all aviation rules and innovative functionalities.

The **EASA eRules** system is developed and implemented in close cooperation with Member States and aviation industry to ensure that all its capabilities are relevant and effective.

Published June 2021<sup>1</sup>

### Copyright notice

© European Union, 1998-2021

Unless otherwise specified, you can re-use the legal documents published in EUR-Lex for commercial or non-commercial purposes [...] ('© European Union, <http://eur-lex.europa.eu/>, 1998-2021')<sup>2</sup>

<sup>1</sup> The published date represents the date when the consolidated version of the document was generated.

<sup>2</sup> Euro-Lex, Important Legal Notice: <http://eur-lex.europa.eu/content/legal-notice/legal-notice.html>.

## DISCLAIMER

This version is issued by the European Union Aviation Safety Agency (referred to as both 'EASA' and 'the Agency') in order to provide its stakeholders with an updated and easy-to-read publication. It has been prepared by putting together the officially published regulations with the related acceptable means of compliance and guidance material (including the amendments) adopted so far and certification specifications and guidance material. However, this is not an official publication and EASA accepts no liability for damage of any kind resulting from the risks inherent in the use of this document.

## LIST OF REVISIONS

Published	Reason for revision
August 2017	First Easy Access Rules for Aerodromes document powered by eRules.
January 2018	To incorporate ED Decision 2017/021/R issuing Certification Specifications and Guidance Material for Aerodrome Design (CS ADR-DSN) 'CS ADR-DSN — Issue 4'.
May 2019	To incorporate Regulation (EU) 2018/401 of 14 March 2018 amending Regulation (EU) No 139/2014 as regards the classification of runways. To incorporate ED Decision 2019/012/R issuing Certification Specifications and Guidance Material for the design of surface-level VFR heliports located at aerodromes that fall under the scope of Regulation (EU) 2018/1139 'CS-HPT-DSN — Issue 1'.
November 2020	To incorporate ED Decision 2020/009/R issuing Amendment 3 to Issue 1 of the Acceptable Means of Compliance and Guidance Material to Regulation (EU) No 139/2014 'AMC/GM to Authority, Organisation and Operations Requirements for Aerodromes – Issue 1, Amendment 3'.
June 2021	To incorporate Regulations (EU) 2020/469 (Requirements for air traffic management/air navigation services, design of airspace structures and data quality, runway safety), (EU) 2020/1234 (Conditions and procedures for the declaration by organisations responsible for the provision of apron management services), and (EU) 2020/2148 (Runway safety and aeronautical data), as well as ED Decisions 2020/021/R (AMC & GM to the Authority, Organisation and Operations Requirements for Aerodromes Issue 1, Amdt 4 — Requirements for the provision of apron management services at aerodromes), 2021/003/R (AMC & GM to Regulation (EU) No 139/2014 Issue 1, Amdt 5 — Runway safety), and 2021/004/R (CS-ADR-DSN Issue 5 — Runway safety).

## NOTE FROM THE EDITOR

The content of this document is arranged as follows: the cover regulation (recitals and articles) of the implementing rule (IR) appear first, then the IR annex points, followed by the related acceptable means of compliance (AMC) and guidance material (GM) paragraph(s).

In case of certification specifications (CSs), a CS paragraph is followed by the related GM paragraph.

All elements (i.e. cover regulation, IRs, AMC, CS, and GM) are colour-coded and can be identified according to the illustration below. The Commission regulation or EASA Executive Director (ED) decision through which the point or paragraph was introduced or last amended is indicated below the point or paragraph title(s) *in italics*.

<b><u>Cover regulation article</u></b>	<i>Commission regulation</i>
<b>Implementing rule annex</b>	<i>Commission regulation</i>
<b>Acceptable means of compliance</b>	<i>ED decision</i>
<b>Certification specification</b>	<i>ED decision</i>
<b>Guidance material</b>	<i>ED decision</i>

**Note 1:** in some instances (e.g. [ADR.AR.B.005](#) Management system) the source of an implementing rule is indicated at the level of the point paragraph (e.g. [ADR.AR.B.005\(a\)\(1\)](#)).

**Note 2:**

*Amendments introduced by Regulations (EU) 2020/1234 (Conditions and procedures for the declaration by organisations responsible for the provision of apron management services), and (EU) 2020/2148 (Runway safety and aeronautical data) with the applicability date in the future and the related acceptable means of compliance and guidance material introduced by ED Decisions 2020/021/R (AMC & GM to the Authority, Organisation and Operations Requirements for Aerodromes Issue 1, Amdt 4 — Requirements for the provision of apron management services at aerodromes) and 2021/003/R (AMC & GM to Regulation (EU) No 139/2014 Issue 1, Amdt 5 — Runway safety) are marked with a different colour with the respective applicability date.*

This document will be updated regularly to incorporate further amendments.

The format of this document has been adjusted to make it user-friendly and for reference purposes. Any comments should be sent to [erules@easa.europa.eu](mailto:erules@easa.europa.eu).

## INCORPORATED AMENDMENTS

### IMPLEMENTING RULES (IRs) (COMMISSION REGULATIONS)

Incorporated Commission Regulation	Affected Part	Regulation amendment	Applicability date <sup>1</sup>
<a href="#">Regulation (EU) No 139/2014</a>	Annex I (Definitions)	Initial issue	06/03/2014
	Annex II (Part-ADR.AR)		
	Annex III (Part-ADR.OR)		
	Annex IV (Part-ADR.OPS)		
<a href="#">Regulation (EU) 2018/401</a>	Annex I (Definitions)	1st amending regulation	04/04/2018
<a href="#">Regulation (EU) 2020/469</a>	Annex III (Part-ADR.OR)	2nd amending regulation (amended)	27/01/2022
<a href="#">Regulation (EU) 2020/1234</a>	Cover Regulation	3rd amending regulation	20/03/2022
	Annex II (Part-ADR.AR)		
	Annex III (Part-ADR.OR)		
	Annex IV (Part-ADR.OPS)		
<a href="#">Regulation (EU) 2020/2148</a>	Annex I (Definitions)	4th amending regulation	Various applicability dates: 07/01/2021 12/08//2021 27/1/2022
	Annex III (Part-ADR.OR)		
	Annex IV (Part-ADR.OPS)		

### AMC/GM TO IR (ED DECISIONS)

Incorporated ED Decision	Affected AMC/GM	Issue/ Amendment No	Applicability date
<a href="#">ED Decision 2014/012/R</a>	AMC/GM to Annex II (Part-ADR.AR)	Initial issue	06/03/2014
	AMC/GM to Annex III (Part-ADR.OR)		
	AMC/GM to Annex IV (Part-ADR.OPS)		
<a href="#">ED Decision 2016/009/R</a>	AMC/GM to Annex IV (Part-ADR.OPS)	Amendment 1	25/05/2016
<a href="#">ED Decision 2017/017/R</a>	AMC/GM to Annex IV (Part-ADR.OPS)	Amendment 2	12/07/2017
<a href="#">ED Decision 2020/009/R</a>	AMC/GM to Annex IV (Part-ADR.OPS)	Issue 1, Amendment 3	16/07/2020
<a href="#">ED Decision 2020/021/R</a>	AMC/GM to Annex II (Part-ADR.AR)	Issue 1, Amendment 4	20/03/2022
	AMC/GM to Annex III (Part-ADR.OR)		
	AMC/GM to Annex IV (Part-ADR.OPS)		
<a href="#">ED Decision 2021/003/R</a>	AMC/GM to Annex I (Definitions)	Issue 1, Amendment 5	Various applicability dates:
	AMC/GM to Annex II (Part-ADR.AR)		
	AMC/GM to Annex III (Part-ADR.OR)		

<sup>1</sup> This date is the earliest applicability date for this regulation. Some provisions of the regulation may be applicable at a later date. Besides, there may be some opt-out filed by the Member States.

	AMC/GM to Annex IV (Part-ADR.OPS)		12/08/2021 27/01/2022 20/03/2022
--	-----------------------------------	--	----------------------------------------

## CS/GM (ED DECISIONS)

ED Decision	Affected book	Issue No	Applicability date
<a href="#">ED Decision 2014/013/R</a>	Book 1 – CS to CS-ADR-DSN	Initial issue	07/03/2014
	Book 2 – GM to CS-ADR-DSN		
<a href="#">ED Decision 2015/001/R</a>	Book 1 – CS to CS-ADR-DSN	Issue 2	31/01/2015
	Book 2 – GM to CS-ADR-DSN		
<a href="#">ED Decision 2016/027/R</a>	Book 1 – CS to CS-ADR-DSN	Issue 3	15/12/2016
	Book 2 – GM to CS-ADR-DSN		
<a href="#">ED Decision 2017/021/R</a>	Book 1 – CS to CS-ADR-DSN	Issue 4	12/12/2017
	Book 2 – GM to CS-ADR-DSN		
<a href="#">ED Decision 2019/012/R</a>	CS-HPT-DSN	Issue 1	24/5/2019
<a href="#">ED Decision 2021/004/R</a>	CS-ADR-DSN	Issue 5	Various applicability dates: 05/03/2021 12/08/2021

*Note: To access the official source documents, please use the links provided above.*

---

## TABLE OF CONTENTS

<b>Disclaimer .....</b>	<b>3</b>
<b>List of Revisions.....</b>	<b>4</b>
<b>Note from the editor .....</b>	<b>5</b>
<b>Incorporated amendments.....</b>	<b>6</b>
<b>Table of contents.....</b>	<b>8</b>
<b>Cover Regulation .....</b>	<b>41</b>
<b>Article 1 Subject matter and scope .....</b>	<b>42</b>
<b>Article 2 Definitions.....</b>	<b>43</b>
Terminology.....	45
<b>Article 3 Oversight of aerodromes [until 19 March 2022] .....</b>	<b>45</b>
<b>Article 3 Oversight [from 20 March 2022 — Delegated Regulation (EU)     2020/1234] .....</b>	<b>45</b>
GM1 to Article 3.2 Oversight of aerodromes.....	46
<b>Article 4 Information to the European Aviation Safety Agency .....</b>	<b>46</b>
<b>Article 5 Exemptions .....</b>	<b>46</b>
<b>Article 6 Conversion of certificates .....</b>	<b>47</b>
<b>Article 7 Deviations from certification specifications.....</b>	<b>47</b>
<b>Article 8 Safeguarding of aerodrome surroundings .....</b>	<b>48</b>
GM1 to Article 8 Safeguarding of aerodrome surroundings.....	48
<b>Article 9 Monitoring of aerodrome surroundings .....</b>	<b>48</b>
<b>Article 10 Wildlife hazard management.....</b>	<b>48</b>
<b>Article 11 Entry into force and application .....</b>	<b>49</b>
<b>Annex I — Definitions for terms used in Annexes II to IV .....</b>	<b>50</b>
GM1 38 (b) Runway condition code .....	56
GM1 38 (g) Runway surface condition.....	56
GM1 38 (h) Runway surface condition descriptors .....	56



---

GM1 38h (c) Runway surface condition descriptors.....	56
GM1 38h (f) Runway surface condition descriptors .....	56
GM1 38h (g) Runway surface condition descriptors .....	57
GM1 41 (a) Slippery wet runway .....	57
GM2 41 (a) Slippery wet runway .....	57
GM1 41 (c) Specially prepared winter runway.....	57
<b>Annex II — Part-ADR.AR .....</b>	<b>58</b>
<b>SUBPART A — GENERAL REQUIREMENTS (ADR.AR.A) .....</b>	<b>58</b>
ADR.AR.A.001 Scope .....	58
ADR.AR.A.005 Competent Authority .....	58
ADR.AR.A.010 Oversight documentation .....	58
GM1 ADR.AR.A.010(b) Oversight documentation .....	59
ADR.AR.A.015 Means of compliance .....	59
AMC1 ADR.AR.A.015(d)(3) Means of compliance .....	60
GM1 ADR.AR.A.015 Means of compliance .....	61
ADR.AR.A.025 Information to the Agency .....	61
ADR.AR.A.030 Immediate reaction to a safety problem .....	61
AMC1 ADR.AR.A.030(d) Immediate reaction to a safety problem .....	62
ADR.AR.A.040 Safety directives.....	62
GM1 ADR.AR.A.040(b) Safety directives .....	63
GM1 ADR.AR.A.040(b) Safety directives .....	63
<b>SUBPART B — MANAGEMENT (ADR.AR.B) .....</b>	<b>65</b>
ADR.AR.B.005 Management system.....	65
AMC1 ADR.AR.B.005(a) Management system .....	65
GM1 ADR.AR.B.005(a) Management system .....	66
AMC1 ADR.AR.B.005(a)(1) Management system.....	67
AMC2 ADR.AR.B.005(a)(1) Management system.....	67
AMC1 ADR.AR.B.005(a)(2) Management system.....	68
AMC2 ADR.AR.B.005(a)(2) Management system.....	69
AMC2 ADR.AR.B.005(a)(2) Management system.....	71
AMC3 ADR.AR.B.005(a)(2) Management system.....	73
GM1 ADR.AR.B.005(a)(2) Management system .....	74
GM1 ADR.AR.B.005(a)(2) Management system .....	76
GM2 ADR.AR.B.005(a)(2) Management system .....	78
GM2 ADR.AR.B.005(a)(2) Management system .....	78
GM3 ADR.AR.B.005(a)(2) Management system .....	78
GM4 ADR.AR.B.005(a)(2) Management system .....	78
GM5 ADR.AR.B.005(a)(2) Management system .....	79
GM6 ADR.AR.B.005(a)(2) Management system .....	79
GM1 ADR.AR.B.005(a)(3) Management system .....	80

---

AMC1 ADR.AR.B.005(a)(4) Management system.....	80
AMC1 ADR.AR.B.005(c) Management system .....	80
<b>ADR.AR.B.010 Allocation of tasks to qualified entities .....</b>	<b>81</b>
AMC1 ADR.AR.B.010(a)(1) Allocation of tasks to qualified entities.....	81
GM1 ADR.AR.B.010 Allocation of tasks to qualified entities.....	81
GM1 ADR.AR.B.010 Allocation of tasks to qualified entities.....	82
<b>ADR.AR.B.015 Changes to the management system.....</b>	<b>82</b>
<b>ADR.AR.B.020 Record keeping .....</b>	<b>82</b>
AMC1 ADR.AR.B.020(a) Record-keeping .....	83
AMC1 ADR.AR.B.020(a)(1);(a)(2);(a)(3) Record-keeping .....	83
AMC1 ADR.AR.B.020(a)(2) Record keeping .....	84
AMC1 ADR.AR.B.020(a)(4);(a)(5) Record keeping .....	84
AMC1 ADR.AR.B.020(a)(4);(a)(5) Record keeping .....	84
AMC1 ADR.AR.B.020(c) Record keeping.....	85
AMC1 ADR.AR.B.020(c) Record keeping.....	86
GM1 ADR.AR.B.020 Record keeping.....	87
GM1 ADR.AR.B.020(a) Record keeping .....	87
GM2 ADR.AR.B.020(a) Record keeping .....	87
GM2 ADR.AR.B.020(a) Record keeping .....	87
<b>SUBPART C — OVERSIGHT, CERTIFICATION AND ENFORCEMENT</b>	
<b>(ADR.AR.C) .....</b>	<b>88</b>
<b>ADR.AR.C.005 Oversight.....</b>	<b>88</b>
AMC1 ADR.AR.C.005 Oversight.....	89
GM1 ADR.AR.C.005 Oversight.....	89
<b>ADR.AR.C.010 Oversight programme .....</b>	<b>89</b>
AMC1 ADR.AR.C.010 Oversight programme .....	90
GM1 ADR.AR.C.010 Oversight programme.....	92
GM1 ADR.AR.C.010 Oversight programme.....	93
AMC1 ADR.AR.C.010(b) Oversight programme .....	93
AMC1 ADR.AR.C.010(b) Oversight programme .....	94
AMC1 ADR.AR.C.010(b);(c) Oversight programme .....	94
AMC1 ADR.AR.C.010(b);(c) Oversight programme .....	95
AMC2 ADR.AR.C.010(b);(c) Oversight programme .....	95
GM1 ADR.AR.C.010(b) Oversight programme .....	96
GM1 ADR.AR.C.010(b) Oversight programme .....	96
GM2 ADR.AR.C.010(b) Oversight programme .....	97
GM2 ADR.AR.C.010(b) Oversight programme .....	97
GM3 ADR.AR.C.010(b) Oversight programme .....	98
<b>ADR.AR.C.015 Initiation of certification process.....</b>	<b>98</b>
AMC1 ADR.AR.C.015(a) Initiation of the certification process .....	98
AMC1 ADR.AR.C.015(c) Initiation of the certification process .....	99
AMC2 ADR.AR.C.015(c) Initiation of the certification process .....	99
GM1 ADR.AR.C.015 Initiation of the certification process .....	99
GM1 ADR.AR.C.015(b) Initiation of the certification process .....	100
GM1 ADR.AR.C.015(c) Initiation of the certification process .....	100

<b>ADR.AR.C.020 Certification basis.....</b>	<b>100</b>
AMC1 ADR.AR.C.020(a) Certification basis .....	101
AMC1 ADR.AR.C.020(b);(c) Certification basis .....	101
GM1 ADR.AR.C.020(b) Certification basis.....	101
<b>ADR.AR.C.025 Special conditions .....</b>	<b>102</b>
<b>ADR.AR.C.035 Issuance of certificates .....</b>	<b>102</b>
GM1 ADR.AR.C.035(a) Issuance of certificates .....	103
GM2 ADR.AR.C.035(a) Issuance of certificates .....	103
GM3 ADR.AR.C.035(a) Issuance of certificates .....	104
GM1 ADR.AR.C.035(b)(1) Issuance of certificates .....	105
AMC1 ADR.AR.C.035(b)(2) Issuance of certificates .....	105
GM1 ADR.AR.C.035(b)(2) Issuance of certificates .....	106
AMC1 ADR.AR.C.035(c) Issuance of certificates.....	107
GM1 ADR.AR.C.035(c) Issuance of certificates .....	108
AMC1 ADR.AR.C.035(d) Issuance of certificates .....	109
AMC2 ADR.AR.C.035(d) Issuance of certificates .....	109
GM1 ADR.AR.C.035(d) Issuance of certificates .....	109
GM1 ADR.AR.C.035(e) Issuance of certificates .....	109
GM1 ADR.AR.C.035(e) Issuance of certificates .....	111
AMC1 ADR.AR.C.035(h) Issuance of certificates .....	112
<b>ADR.AR.C.040 Changes [until 19 March 2022] .....</b>	<b>112</b>
<b>ADR.AR.C.040 Changes — aerodrome operator [from 20 March 2022 — Delegated Regulation (EU) 2020/1234] .....</b>	<b>112</b>
AMC1 ADR.AR.C.040(a) Changes [until 19 March 2022]/Changes — aerodrome operator [from 20 March 2022 — ED Decision 2020/021/R].....	113
AMC2 ADR.AR.C.040(a) Changes [until 19 March 2022]/Changes — aerodrome operator [from 20 March 2022 — ED Decision 2020/021/R].....	114
AMC1 ADR.AR.C.040(a);(f) Changes [until 19 March 2022]/Changes — aerodrome operator [from 20 March 2022 — ED Decision 2020/021/R].....	115
GM1 ADR.AR.C.040(c) Changes [until 19 March 2022]/Changes — aerodrome operator [from 20 March 2022 — ED Decision 2020/021/R] .....	115
GM1 ADR.AR.C.040(d) Changes [until 19 March 2022]/Changes — aerodrome operator [from 20 March 2022 — ED Decision 2020/021/R] .....	116
<b>ADR.AR.C.050 Declarations of providers of apron management services .....</b>	<b>116</b>
<b>ADR.AR.C.050 Declaration of organisations responsible for the provision of AMS and notification of a change .....</b>	<b>116</b>
GM1 ADR.AR.C.050 Declarations of providers of apron management services [until 19 March 2022]/Declaration of organisations responsible for the provision of AMS and notification of a change [from 20 March 2022 — ED Decision 2020/021/R].....	117
<b>ADR.AR.C.055 Findings, observations, corrective actions and enforcement measures .....</b>	<b>117</b>
GM1 ADR.AR.C.055 Findings, observations, corrective actions, and enforcement measures.....	118
GM2 ADR.AR.C.055 Findings, observations, corrective actions, and enforcement measures.....	119

---

GM3 ADR.AR.C.055 Findings, observations, corrective actions, and enforcement measures.....	119
<b>Annex III — Part-ADR.OR.....</b>	<b>120</b>
<b>SUBPART A — GENERAL REQUIREMENTS (ADR.OR.A) .....</b>	<b>120</b>
ADR.OR.A.005 Scope .....	120
ADR.OR.A.010 Competent Authority.....	120
ADR.OR.A.015 Means of compliance.....	120
AMC1 ADR.OR.A.015 Means of compliance .....	121
<b>SUBPART B — CERTIFICATION (ADR.OR.B) [until 19 March 2022] /</b>	
<b>SUBPART B — CERTIFICATION — AERODROMES AND AERODROME</b>	
<b>OPERATORS (ADR.OR.B) [from 20 March 2022 — Delegated Regulation</b>	
<b>(EU) 2020/1234] .....</b>	<b>122</b>
ADR.OR.B.005 Certification obligations of aerodromes and aerodrome operators .....	122
ADR.OR.B.015 Application for a certificate.....	122
GM1 ADR.OR.B.015 Application for a certificate .....	123
AMC1 ADR.OR.B.015(a) Application for a certificate .....	123
AMC1 ADR.OR.B.015(b)(1);(2);(3);(4) Application for a certificate.....	123
GM1 ADR.OR.B.015(b)(2) Application for a certificate .....	125
GM1 ADR.OR.B.015(b)(2)(3)(4) Application for a certificate .....	125
AMC1 ADR.OR.B.015(b)(4) Application for a certificate.....	125
AMC1 ADR.OR.B.015(b)(5) Application for a certificate.....	125
GM1 ADR.OR.B.015(b)(5) Application for a certificate .....	126
AMC1 ADR.OR.B.015(b)(6) Application for a certificate.....	127
AMC1 ADR.OR.B.015(b)(7) Application for a certificate.....	127
AMC1 ADR.OR.B.015(b)(9) Application for a certificate.....	127
ADR.OR.B.025 Demonstration of compliance.....	127
AMC1 ADR.OR.B.025(a)(1) Demonstration of compliance .....	128
AMC2 ADR.OR.B.025(a)(1) Demonstration of compliance .....	128
GM1 ADR.OR.B.025(a)(3) Demonstration of compliance .....	129
ADR.OR.B.030 Terms of the certificate and privileges of the certificate holder .	129
ADR.OR.B.035 Continued validity of a certificate .....	130
ADR.OR.B.037 Continued validity of a declaration of a provider of apron management services .....	130
ADR.OR.B.040 Changes .....	130
AMC1 ADR.OR.B.040(a);(b) Changes .....	131
GM1 ADR.OR.B.040(a);(b) Changes.....	132
GM1 ADR.OR.B.040(f) Changes.....	133
GM2 ADR.OR.B.040(f) Changes.....	134
GM3 ADR.OR.B.040(f) Changes.....	134

---

ADR.OR.B.050 Continuing compliance with the Agency’s certification specifications .....	134
ADR.OR.B.060 Declaration of providers of apron management services .....	134
GM1 ADR.OR.B.060 Declaration of providers of apron management services .....	135
ADR.OR.B.065 Termination of operation.....	136
AMC1 ADR.OR.B.065 Termination of operation .....	136
ADR.OR.B.070 Termination of the provision of apron management service.....	136
<b>SUBPART C — ADDITIONAL AERODROME OPERATOR RESPONSIBILITIES (ADR.OR.C).....</b>	<b>137</b>
ADR.OR.C.005 Aerodrome operator responsibilities .....	137
AMC1 ADR.OR.C.005(c) Aerodrome operator responsibilities .....	137
ADR.OR.C.015 Access .....	138
ADR.OR.C.020 Findings and corrective actions .....	138
AMC1 ADR.OR.C.020(b) Findings .....	138
GM1 ADR.OR.C.020 Findings.....	138
ADR.OR.C.025 Immediate reaction to a safety problem — compliance with safety directives .....	139
ADR.OR.C.030 Occurrence reporting .....	139
AMC1 ADR.OR.C.030 Occurrence reporting.....	140
AMC1 ADR.OR.C.030 Occurrence reporting.....	140
ADR.OR.C.040 Prevention of fire .....	141
AMC1 ADR.OR.C.040 Prevention of fire .....	141
ADR.OR.C.045 Use of alcohol, psychoactive substances and medicines.....	141
GM1 ADR.OR.C.045 Use of alcohol, psychoactive substances and medicines .....	142
<b>SUBPART D — MANAGEMENT (ADR.OR.D) [until 19 March 2022] / SUBPART D — MANAGEMENT — AERODROME OPERATORS (ADR.OR.D) [from 20 March 2022 — Delegated Regulation (EU) 2020/1234] .....</b>	<b>143</b>
ADR.OR.D.005 Management system .....	143
AMC1 ADR.OR.D.005(b)(1) Management system .....	144
GM1 ADR.OR.D.005(b)(1) Management system .....	145
GM2 ADR.OR.D.005(b)(1) Management system .....	146
AMC1 ADR.OR.D.005(b)(2) Management system .....	146
GM1 ADR.OR.D.005(b)(2) Management system .....	147
AMC1 ADR.OR.D.005(b)(3) Management system .....	148
GM1 ADR.OR.D.005(b)(3) Management system .....	148
AMC1 ADR.OR.D.005(b)(4) Management system .....	152
GM1 ADR.OR.D.005(b)(4) Management system .....	152
AMC1 ADR.OR.D.005(b)(5) Management system .....	152
GM1 ADR.OR.D.005(b)(5) Management system .....	152
AMC1 ADR.OR.D.005(b)(6) Management system .....	153
GM1 ADR.OR.D.005(b)(6) Management system .....	153

AMC1 ADR.OR.D.005(b)(7) Management system .....	154
GM1 ADR.OR.D.005(b)(7) Management system .....	154
AMC1 ADR.OR.D.005(b)(8) Management system .....	155
GM1 ADR.OR.D.005(b)(8) Management system .....	155
AMC1 ADR.OR.D.005(b)(9) Management system .....	156
GM1 ADR.OR.D.005(b)(9) Management system .....	156
AMC1 ADR.OR.D.005(b)(10) Management system .....	157
GM1 ADR.OR.D.005(b)(10) Management system .....	157
AMC1 ADR.OR.D.005(b)(11) Management system .....	157
GM1 ADR.OR.D.005(b)(11) Management system .....	160
AMC2 ADR.OR.D.005(b)(11) Management system .....	160
AMC1 ADR.OR.D.005(c) Management system.....	161
AMC2 ADR.OR.D.005(c) Management system.....	161
GM1 ADR.OR.D.005(c) Management system.....	162
<b>ADR.OR.D.007 Management of aeronautical data and aeronautical information</b> .....	<b>162</b>
<b>ADR.OR.D.007 Management of aeronautical data and aeronautical information</b> .....	<b>162</b>
AMC1 ADR.OR.D.007(a) Management of aeronautical data and aeronautical information .....	163
GM1 ADR.OR.D.007(a) Management of aeronautical data and aeronautical information .....	164
AMC1 ADR.OR.D.007(b) Management of aeronautical data and aeronautical information .....	164
GM1 ADR.OR.D.007(b) Management of aeronautical data and aeronautical information .....	164
<b>ADR.OR.D.010 Contracted activities .....</b>	<b>165</b>
AMC1 ADR.OR.D.010 Contracted activities .....	165
GM1 ADR.OR.D.010 Contracted activities .....	165
GM2 ADR.OR.D.010 Contracted activities .....	166
<b>ADR.OR.D.015 Personnel requirements .....</b>	<b>166</b>
AMC1 ADR.OR.D.015(a) Personnel requirements.....	167
GM1 ADR.OR.D.015(a) Personnel requirements .....	168
AMC1 ADR.OR.D.015(b) Personnel requirements .....	168
GM1 ADR.OR.D.015(b) Personnel requirements .....	169
AMC1 ADR.OR.D.015(c) Personnel requirements .....	169
AMC1 ADR.OR.D.015(d) Personnel requirements .....	170
GM1 ADR.OR.D.015(d) Personnel requirements .....	171
AMC1 ADR.OR.D.015(d);(e) Personnel requirements .....	171
GM1 ADR.OR.D.015(d);(e) Personnel requirements .....	171
<b>ADR.OR.D.017 Training and proficiency check programmes .....</b>	<b>171</b>
AMC1 ADR.OR.D.017(a);(b) Training and proficiency check programmes .....	173
AMC1 ADR.OR.D.017(c);(d) Training and proficiency check programmes .....	174
GM1 ADR.OR.D.017(a);(b);(c);(d) Training and proficiency check programmes.....	174
AMC1 ADR.OR.D.017(e) Training and proficiency check programmes .....	176
AMC2 ADR.OR.D.017(e) Training and proficiency check programmes .....	177
GM1 ADR.OR.D.017(e) Training and proficiency check programmes .....	177

AMC1 ADR.OR.D.017(f) Training and proficiency check programmes .....	178
AMC1 ADR.OR.D.017(g) Training and proficiency check programmes .....	179
GM1 ADR.OR.D.017(g) Training and proficiency check programmes .....	180
AMC1 ADR.OR.D.017(h) Training and proficiency check programmes .....	180
AMC1 ADR.OR.D.017(i) Training and proficiency check programmes .....	181
AMC2 ADR.OR.D.017(i) Training and proficiency check programmes .....	182
AMC3 ADR.OR.D.017(i) Training and proficiency check programmes .....	182
<b>ADR.OR.D.020 Facilities requirements .....</b>	<b>183</b>
GM1 ADR.OR.D.020(a) Facilities requirements.....	183
AMC1 ADR.OR.D.020(b) Facilities requirements .....	183
<b>ADR.OR.D.025 Coordination with other organisations .....</b>	<b>183</b>
GM1 ADR.OR.D.025 Coordination with other organisations.....	184
GM2 ADR.OR.D.025 Coordination with other organisations.....	184
<b>ADR.OR.D.027 Safety programmes .....</b>	<b>184</b>
AMC1 ADR.OR.D.027 Safety programmes.....	184
GM1 ADR.OR.D.027 Safety programmes.....	185
GM2 ADR.OR.D.027 Safety programmes.....	186
AMC2 ADR.OR.D.027 Safety programmes.....	188
GM3 ADR.OR.D.027 Safety programmes.....	188
<b>ADR.OR.D.030 Safety reporting system.....</b>	<b>191</b>
AMC1 ADR.OR.D.030 Safety reporting system .....	192
GM1 ADR.OR.D.030 Safety reporting system .....	193
<b>ADR.OR.D.035 Record keeping .....</b>	<b>193</b>
AMC1 ADR.OR.D.035 Record keeping .....	194
AMC2 ADR.OR.D.035 Record keeping .....	194
GM1 ADR.OR.D.035(b) Record keeping.....	195
<b>SUBPART E — AERODROME MANUAL AND DOCUMENTATION</b>	
<b>(ADR.OR.E) .....</b>	<b>196</b>
<b>ADR.OR.E.005 Aerodrome manual .....</b>	<b>196</b>
AMC1 ADR.OR.E.005 Aerodrome manual .....	197
GM1 ADR.OR.E.005 Aerodrome manual .....	198
AMC2 ADR.OR.E.005(i)(2) Aerodrome manual .....	199
AMC3 ADR.OR.E.005 Aerodrome manual .....	199
GM2 ADR.OR.E.005 Aerodrome manual .....	207
GM1 ADR.OR.E.005(j) Aerodrome manual .....	207
<b>ADR.OR.E.010 Documentation requirements.....</b>	<b>207</b>
<b>SUBPART F — APRON MANAGEMENT SERVICE (ADR.OR.F).....</b>	<b>208</b>
<b>ADR.OR.F.001 Responsibilities of the organisation responsible for the provision of AMS .....</b>	<b>208</b>
<b>ADR.OR.F.005 Declaration of the organisation responsible for the provision of AMS .....</b>	<b>208</b>
GM1 ADR.OR.F.005(a) Declaration of the organisation responsible for the provision of AMS .....	209

---

GM2 ADR.OR.F.005(a) Declaration of the organisation responsible for the provision of AMS .....	209
<b>ADR.OR.F.010 Continued validity of the declaration .....</b>	<b>210</b>
<b>ADR.OR.F.015 Start of the provision of apron management service .....</b>	<b>210</b>
<b>ADR.OR.F.020 Termination of the provision of apron management service .....</b>	<b>211</b>
AMC1 ADR.OR.F.020(a) Termination of the provision of apron management services (AMS) .....	211
<b>ADR.OR.F.025 Changes.....</b>	<b>211</b>
GM1 ADR.OR.F.025(d) Changes .....	212
<b>ADR.OR.F.030 Access .....</b>	<b>213</b>
<b>ADR.OR.F.035 Findings and corrective actions .....</b>	<b>213</b>
<b>ADR.OR.F.040 Immediate reaction to a safety problem — compliance with safety directives .....</b>	<b>213</b>
<b>ADR.OR.F.045 Management system.....</b>	<b>214</b>
AMC1 ADR.OR.F.045(b)(1) Management system.....	215
GM1 ADR.OR.F.045(b)(1) Management system .....	215
GM2 ADR.OR.F.045(b)(1) Management system .....	215
GM3 ADR.OR.F.045(b)(1) Management system .....	216
GM4 ADR.OR.F.045(b)(1) Management system .....	217
AMC1 ADR.OR.F.045(b)(2) Management system.....	217
GM1 ADR.OR.F.045(b)(2) Management system .....	218
AMC1 ADR.OR.F.045(b)(3) Management system.....	218
GM1 ADR.OR.F.045(b)(3) Management system .....	219
AMC1 ADR.OR.F.045(b)(4) Management system.....	222
GM1 ADR.OR.F.045(b)(4) Management system .....	222
AMC1 ADR.OR.F.045(b)(5) Management system.....	223
GM1 ADR.OR.F.045(b)(5) Management system .....	223
AMC1 ADR.OR.F.045(b)(6) Management system.....	224
GM1 ADR.OR.F.045(b)(6) Management system .....	224
AMC1 ADR.OR.F.045(b)(7) Management system.....	225
GM1 ADR.OR.F.045(b)(7) Management system .....	225
AMC1 ADR.OR.F.045(b)(8) Management system.....	225
GM1 ADR.OR.F.045(b)(8) Management system .....	226
AMC1 ADR.OR.F.045(b)(9) Management system.....	227
GM1 ADR.OR.F.045(b)(9) Management system .....	227
AMC1 ADR.OR.F.045(b)(10) Management system.....	227
GM1 ADR.OR.F.045(b)(10) Management system.....	230
AMC2 ADR.OR.F.045(b)(10) Management system.....	230
AMC1 ADR.OR.F.045(c) Management system .....	231
AMC2 ADR.OR.F.045(c) Management system .....	231
GM1 ADR.OR.F.045(c) Management system .....	232
<b>ADR.OR.F.050 Reporting malfunctions of systems used for the provision of apron management services .....</b>	<b>232</b>
<b>ADR.OR.F.055 Safety reporting system .....</b>	<b>232</b>



---

AMC1 ADR.OR.F.055 Safety reporting system .....	233
GM1 ADR.OR.F.055 Safety reporting system .....	234
AMC1 ADR.OR.F.055(a) Safety reporting system .....	234
<b>ADR.OR.F.060 Safety programmes .....</b>	<b>234</b>
<b>ADR.OR.F.065 Personnel requirements .....</b>	<b>234</b>
AMC1 ADR.OR.F.065(a)(1) Personnel requirements .....	235
GM1 ADR.OR.F.065(a)(1) Personnel requirements .....	236
AMC1 ADR.OR.F.065(a)(2) Personnel requirements .....	237
AMC1 ADR.OR.F.065(a)(3) Personnel requirements .....	237
GM1 ADR.OR.F.065(a)(2);(a)(3) Personnel requirements .....	238
AMC1 ADR.OR.F.065(a)(4) Personnel requirements .....	239
GM1 ADR.OR.F.065(a)(4) Personnel requirements .....	239
<b>ADR.OR.F.075 Use of alcohol, psychoactive substances and medicines .....</b>	<b>239</b>
<b>ADR.OR.F.080 Record-keeping .....</b>	<b>239</b>
AMC1 ADR.OR.F.080 Record keeping .....	240
GM1 ADR.OR.F.080 Record keeping .....	241
<b>ADR.OR.F.085 Formal arrangement between the organisation responsible for the provision of AMS and the aerodrome operator .....</b>	<b>241</b>
<b>ADR.OR.F.090 Formal arrangement between the organisation responsible for the provision of AMS and the air traffic service provider .....</b>	<b>241</b>
<b>ADR.OR.F.095 Management system manual .....</b>	<b>242</b>
AMC1 ADR.OR.F.095 Management system manual .....	243
AMC2 ADR.OR.F.095 Management system manual .....	243
GM1 ADR.OR.F.095 Management system manual .....	246
GM2 ADR.OR.F.095 Management system manual .....	246
AMC1 ADR.OR.F.095(g)(1) Management system manual .....	246
<b>ADR.OR.F.100 Documentation requirements .....</b>	<b>247</b>
<b>Annex IV — Part-ADR.OPS .....</b>	<b>248</b>
<b>SUBPART A — AERODROME DATA (ADR.OPS.A) .....</b>	<b>248</b>
<b>ADR.OPS.A.005 Aerodrome data .....</b>	<b>248</b>
AMC1 ADR.OPS.A.005 Aerodrome data .....	248
GM1 ADR.OPS.A.005 Aerodrome data .....	249
GM2 ADR.OPS.A.005(a) Aerodrome data .....	258
GM3 ADR.OPS.A.005(a) Aerodrome data .....	271
GM4 ADR.OPS.A.005(a) Aerodrome data .....	271
<b>ADR.OPS.A.010 Data quality requirements .....</b>	<b>277</b>
<b>ADR.OPS.A.010 Data quality requirements .....</b>	<b>278</b>
AMC1 ADR.OPS.A.010 Data quality requirements .....	278
AMC2 ADR.OPS.A.010 Data quality requirements .....	281
GM1 ADR.OPS.A.010 Data quality requirements .....	283
GM2 ADR.OPS.A.010 Data quality requirements .....	283
GM1 ADR.OPS.A.010(d) Data quality requirements .....	283

---

GM1 ADR.OPS.A.010(e) Data quality requirements .....	284
<b>ADR.OPS.A.015 Coordination between aerodrome operators and providers of aeronautical information services .....</b>	<b>284</b>
AMC1 ADR.OPS.A.015 Coordination between aerodrome operators and providers of aeronautical information services.....	284
<b>ADR.OPS.A.020 Common reference systems .....</b>	<b>285</b>
GM1 ADR.OPS.A.020(a) Common reference systems .....	285
GM2 ADR.OPS.A.020(a) Common reference systems .....	285
AMC1 ADR.OPS.A.020(b) Common reference systems .....	286
GM1 ADR.OPS.A.020(b) Common reference systems .....	286
GM2 ADR.OPS.A.020(b) Common reference systems .....	286
GM1 ADR.OPS.A.020(c) Common reference system .....	287
<b>ADR.OPS.A.025 Data error detection and authentication .....</b>	<b>287</b>
GM1 ADR.OPS.A.025 Data error detection and authentication .....	287
GM2 ADR.OPS.A.025 Data error detection and authentication .....	288
<b>ADR.OPS.A.030 Aeronautical data catalogue .....</b>	<b>288</b>
GM1 ADR.OPS.A.030 Aeronautical Data Catalogue .....	288
<b>ADR.OPS.A.035 Data validation and verification .....</b>	<b>288</b>
AMC1 ADR.OPS.A.035 Data verification and validation.....	289
GM1 ADR.OPS.A.035 Data verification and validation.....	289
GM2 ADR.OPS.A.035 Data verification and validation.....	290
<b>ADR.OPS.A.040 Error handling requirements .....</b>	<b>290</b>
GM1 ADR.OPS.A.040 Error handling requirements .....	291
<b>ADR.OPS.A.045 Metadata .....</b>	<b>291</b>
<b>ADR.OPS.A.050 Data transmission .....</b>	<b>291</b>
<b>ADR.OPS.A.055 Tools and software.....</b>	<b>291</b>
GM1 ADR.OPS.A.055 Tools and software .....	291
GM2 ADR.OPS.A.055 Tools and software .....	292
<b>ADR.OPS.A.057 Origination of NOTAM .....</b>	<b>292</b>
AMC1 ADR.OPS.A.057(a)(1) Origination of NOTAM .....	294
AMC1 ADR.OPS.A.057(a)(2);(3) Origination of NOTAM .....	295
GM1 ADR.OPS.A.057(a)(2);(3) Origination of NOTAM .....	295
GM1 ADR.OPS.A.057(b) Origination of NOTAM .....	296
GM2 ADR.OPS.A.057(b) Origination of NOTAM .....	297
GM1 ADR.OPS.A.057(d)(1) Origination of NOTAM .....	297
GM1 ADR.OPS.A.057(d)(4) Origination of NOTAM .....	297
GM2 ADR.OPS.A.057(d)(4) Origination of NOTAM .....	301
<b>ADR.OPS.A.060 Reporting of surface contaminants .....</b>	<b>302</b>
<b>ADR.OPS.A.065 Reporting of the runway surface condition .....</b>	<b>302</b>
AMC1 ADR.OPS.A.065(a) Reporting of the runway surface condition.....	303
AMC2 ADR.OPS.A.065(a) Reporting of the runway surface condition.....	304
GM1 ADR.OPS.A.065(a) Reporting of the runway surface condition.....	304
GM2 ADR.OPS.A.065(a) Reporting of the runway surface condition.....	305

---

GM3 ADR.OPS.A.065(a) Reporting of the runway surface condition.....	310
GM4 ADR.OPS.A.065(a) Reporting of the runway surface condition.....	310
GM1 ADR.OPS.A.065(a)(18);(19) Reporting of the runway surface condition .....	310
AMC1 ADR.OPS.A.065(b);(c) Reporting of the runway surface condition.....	311
GM1 ADR.OPS.A.065(b);(c) Reporting of the runway surface condition .....	311
GM1 ADR.OPS.A.065(d) Reporting of runway surface condition .....	312
Appendix 1 — NOTAM FORMAT .....	313
Appendix 2 — SNOWTAM FORMAT .....	314
<b>SUBPART B — AERODROME OPERATIONAL SERVICES, EQUIPMENT AND INSTALLATIONS (ADR.OPS.B).....</b>	<b>315</b>
ADR.OPS.B.001 Provision of services.....	315
GM1 ADR.OPS.B.001 Provision of services .....	315
ADR.OPS.B.003 Handover of activities — provision of operational information	315
AMC1 ADR.OPS.B.003(a) Handover of activities — provision of operational information .....	315
GM1 ADR.OPS.B.003(b) Handover of activities — provision of operational information .....	316
ADR.OPS.B.005 Aerodrome emergency planning .....	316
AMC1 ADR.OPS.B.005(b) Aerodrome emergency planning .....	317
AMC2 ADR.OPS.B.005(b) Aerodrome emergency planning .....	317
AMC1 ADR.OPS.B.005(c) Aerodrome emergency planning .....	317
GM1 ADR.OPS.B.005(a) Aerodrome emergency planning .....	318
GM2 ADR.OPS.B.005(a) Aerodrome emergency planning .....	318
GM3 ADR.OPS.B.005(a) Aerodrome emergency planning .....	319
GM4 ADR.OPS.B.005(a) Aerodrome emergency planning .....	323
GM5 ADR.OPS.B.005(a) Aerodrome emergency planning .....	324
GM1 ADR.OPS.B.005(b) Aerodrome emergency planning .....	324
GM2 ADR.OPS.B.005(b) Aerodrome emergency planning .....	325
GM3 ADR.OPS.B.005(b) Aerodrome emergency planning .....	325
GM4 ADR.OPS.B.005(b) Aerodrome emergency planning .....	326
GM5 ADR.OPS.B.005(b) Aerodrome emergency planning .....	326
GM1 ADR.OPS.B.005(c) Aerodrome emergency planning.....	327
GM2 ADR.OPS.B.005(c) Aerodrome emergency planning.....	327
ADR.OPS.B.010 Rescue and firefighting services .....	328
GM1 ADR.OPS.B.010(a)(1) Rescue and firefighting services .....	329
AMC1 ADR.OPS.B.010(a)(2) Rescue and firefighting services.....	329
AMC2 ADR.OPS.B.010(a)(2) Rescue and firefighting services.....	330
AMC3 ADR.OPS.B.010(a)(2) Rescue and firefighting services.....	331
AMC4 ADR.OPS.B.010(a)(2) Rescue and firefighting services.....	332
AMC5 ADR.OPS.B.010(a)(2) Rescue and firefighting services.....	334
AMC6 ADR.OPS.B.010(a)(2) Rescue and firefighting services.....	335
GM1 ADR.OPS.B.010(a)(2) Rescue and firefighting services .....	335
GM2 ADR.OPS.B.010(a)(2) Rescue and firefighting services .....	335
GM3 ADR.OPS.B.010(a)(2) Rescue and firefighting services .....	336
GM4 ADR.OPS.B.010(a)(2) Rescue and firefighting services .....	336
GM5 ADR.OPS.B.010(a)(2) Rescue and firefighting services .....	336

GM6 ADR.OPS.B.010(a)(2) Rescue and firefighting services .....	339
AMC1 ADR.OPS.B.010(a)(4) Rescue and firefighting services.....	340
GM1 ADR.OPS.B.010(a)(4) Rescue and firefighting services.....	341
GM2 ADR.OPS.B.010(a)(4) Rescue and firefighting services.....	345
GM3 ADR.OPS.B.010(a)(4) Rescue and firefighting services.....	366
AMC1 ADR.OPS.B.010(c) Rescue and firefighting services .....	368
AMC1 ADR.OPS.B.010(d) Rescue and firefighting services.....	368
AMC2 ADR.OPS.B.010(d) Rescue and firefighting services.....	369
<b>ADR.OPS.B.015 Monitoring and inspection of movement area and related facilities .....</b>	<b>369</b>
AMC1 ADR.OPS.B.015 Monitoring and Inspection of movement area and related facilities.....	370
AMC2 ADR.OPS.B.015 Monitoring and inspection of movement area and related facilities.....	370
GM1 ADR.OPS.B.015 Monitoring and inspection of movement area and related facilities.....	371
GM2 ADR.OPS.B.015 Monitoring and inspection of movement area and related facilities.....	372
GM3 ADR.OPS.B.015 Monitoring and inspection of movement area and related facilities.....	372
GM4 ADR.OPS.B.015 Monitoring and inspection of movement area and related facilities.....	373
GM5 ADR.OPS.B.015 Monitoring and inspection of movement area and related facilities.....	373
GM6 ADR.OPS.B.015 Monitoring and inspection of movement area and related facilities.....	373
<b>ADR.OPS.B.016 Foreign object debris control programme .....</b>	<b>373</b>
AMC1 ADR.OPS.B.016(a) Foreign object debris control programme.....	374
AMC1 ADR.OPS.B.016(b)(1) Foreign object debris control programme .....	374
GM1 ADR.OPS.B.016(b)(1) Foreign object debris control programme .....	375
AMC1 ADR.OPS.B.016(b)(2) Foreign object debris control programme .....	376
GM1 ADR.OPS.B.016(b)(2) Foreign object debris control programme .....	376
AMC1 ADR.OPS.B.016(b)(3) Foreign object debris control programme .....	378
GM1 ADR.OPS.B.016(b)(3) Foreign object debris control programme .....	379
AMC1 ADR.OPS.B.016(c) Foreign object debris control programme .....	380
GM1 ADR.OPS.B.016(c) Foreign object debris control programme .....	380
<b>ADR.OPS.B.020 Wildlife strike hazard reduction .....</b>	<b>381</b>
AMC1 ADR.OPS.B.020 Wildlife strike hazard reduction.....	381
GM1 ADR.OPS.B.020 Wildlife strike hazard reduction.....	381
GM2 ADR.OPS.B.020 Wildlife strike hazard reduction.....	381
GM3 ADR.OPS.B.020 Wildlife strike hazard reduction.....	382
GM4 ADR.OPS.B.020 Wildlife strike hazard reduction.....	383
<b>ADR.OPS.B.024 Authorisation of vehicle drivers .....</b>	<b>384</b>
GM1 ADR.OPS.B.024(a) Authorisation of vehicle drivers.....	385
GM1 ADR.OPS.B.024(a)(1) Authorisation of vehicle drivers .....	385
AMC1 ADR.OPS.B.024(a)(5) Authorisation of vehicle drivers.....	386
AMC1 ADR.OPS.B.024(b) Authorisation of vehicle drivers.....	386
GM1 ADR.OPS.B.024(b) Authorisation of vehicle drivers.....	387

---

AMC2 ADR.OPS.B.024(b) Authorisation of vehicle drivers.....	387
AMC3 ADR.OPS.B.024(b) Authorisation of vehicle drivers.....	393
GM2 ADR.OPS.B.024(b) Authorisation of vehicle drivers.....	394
GM1 ADR.OPS.B.024(c) Authorisation of vehicle drivers .....	394
AMC1 ADR.OPS.B.024(d) Authorisation of vehicle drivers.....	395
GM1 ADR.OPS.B.024(d) Authorisation of vehicle drivers.....	395
AMC1 ADR.OPS.B.024(e) Authorisation of vehicle drivers.....	395
<b>ADR.OPS.B.026 Authorisation of vehicles.....</b>	<b>396</b>
AMC1 ADR.OPS.B.026(a)(1);(3) Authorisation of vehicles .....	398
GM1 ADR.OPS.B.026(b) Authorisation of vehicles.....	398
AMC1 ADR.OPS.B.026(c)(1) Authorisation of vehicles .....	399
GM1 ADR.OPS.B.026(c)(1) Authorisation of vehicles.....	399
GM1 ADR.OPS.B.026(d) Authorisation of vehicles.....	399
AMC1 ADR.OPS.B.026(e) Authorisation of vehicles .....	399
GM1 ADR.OPS.B.026(e) Authorisation of vehicles.....	400
AMC1 ADR.OPS.B.026(f) Authorisation of vehicles.....	401
<b>ADR.OPS.B.027 Operation of vehicles .....</b>	<b>402</b>
GM1 ADR.OPS.B.027(e)(1) Operation of vehicles .....	404
AMC1 ADR.OPS.B.027(h)(2) Operation of vehicles .....	404
<b>ADR.OPS.B.028 Aircraft towing .....</b>	<b>404</b>
AMC1 ADR.OPS.B.028 Aircraft towing .....	405
GM1 ADR.OPS.B.028 Aircraft towing .....	406
<b>ADR.OPS.B.029 Language proficiency.....</b>	<b>406</b>
AMC1 ADR.OPS.B.029(b) Language proficiency.....	408
AMC1 ADR.OPS.B.029(e) Language proficiency .....	412
AMC2 ADR.OPS.B.029(e) Language proficiency .....	412
AMC3 ADR.OPS.B.029(e) Language proficiency .....	412
AMC4 ADR.OPS.B.029(e) Language proficiency .....	413
GM1 ADR.OPS.B.029(e) Language proficiency.....	413
GM2 ADR.OPS.B.029(e) Language proficiency.....	415
GM3 ADR.OPS.B.029(e) Language proficiency.....	415
AMC1 ADR.OPS.B.029(f) Language proficiency.....	415
GM1 ADR.OPS.B.029(f) Language proficiency .....	415
AMC1 ADR.OPS.B.029(g) Language proficiency .....	415
<b>ADR.OPS.B.030 Surface movement guidance and control system .....</b>	<b>416</b>
AMC1 ADR.OPS.B.030 Surface movement guidance and control system .....	417
GM1 ADR.OPS.B.030 Surface movement guidance and control system .....	417
AMC1 ADR.OPS.B.030(b) Surface movement guidance and control system.....	418
GM1 ADR.OPS.B.030(b) Surface movement guidance and control system.....	418
AMC1 ADR.OPS.B.030(c) Surface movement guidance and control system .....	419
<b>ADR.OPS.B.031 Communications .....</b>	<b>419</b>
GM1 ADR.OPS.B.031(b) Communications .....	419
AMC1 ADR.OPS.B.031(b)(4) Communications .....	420
<b>ADR.OPS.B.033 Control of pedestrians.....</b>	<b>420</b>
AMC1 ADR.OPS.B.033(a) Control of pedestrians .....	421
AMC1 ADR.OPS.B.033(b) Control of pedestrians .....	422

<b>ADR.OPS.B.035 Operations in winter conditions .....</b>	<b>422</b>
<b>ADR.OPS.B.035 Operations in winter conditions .....</b>	<b>422</b>
<b>AMC1 ADR.OPS.B.035 Operations in winter conditions.....</b>	<b>423</b>
<b>GM1 ADR.OPS.B.035 Operations in winter conditions .....</b>	<b>423</b>
<b>AMC1 ADR.OPS.B.035(a) Operations in winter conditions .....</b>	<b>424</b>
<b>AMC2 ADR.OPS.B.035(a) Operations in winter conditions .....</b>	<b>425</b>
<b>AMC1 ADR.OPS.B.035(a)(1) Operations in winter conditions .....</b>	<b>425</b>
<b>AMC1 ADR.OPS.B.035(a)(2) Operations in winter conditions .....</b>	<b>425</b>
<b>GM1 ADR.OPS.B.035(b)(3) Operation in winter conditions .....</b>	<b>425</b>
<b>ADR.OPS.B.036 Operations on specially prepared winter runways .....</b>	<b>426</b>
<b>AMC1 ADR.OPS.B.036(b)(1)(i) Operations on specially prepared winter runways ....</b>	<b>427</b>
<b>GM1 ADR.OPS.B.036(b)(1)(i) Operations on specially prepared winter runways .....</b>	<b>427</b>
<b>AMC1 ADR.OPS.B.036(b)(1)(ii) Operations on specially prepared winter runways ...</b>	<b>428</b>
<b>GM1 ADR.OPS.B.036(b)(1)(iii) Operations on specially prepared winter runways ....</b>	<b>428</b>
<b>AMC1 ADR.OPS.B.036(b)(1)(iv) Operations on specially prepared winter runways...</b>	<b>429</b>
<b>GM1 ADR.OPS.B.036(b)(1)(iv) Operations on specially prepared winter runways ....</b>	<b>429</b>
<b>AMC1 ADR.OPS.B.036(b)(2) Operations on specially prepared winter runways.....</b>	<b>429</b>
<b>GM1 ADR.OPS.B.036(b)(2) Operations on specially prepared winter runways .....</b>	<b>430</b>
<b>AMC1 ADR.OPS.B.036(b)(3) Operations on specially prepared winter runways.....</b>	<b>430</b>
<b>GM1 ADR.OPS.B.036(b)(3) Operations on specially prepared winter runways .....</b>	<b>430</b>
<b>GM1 ADR.OPS.B.036(b)(4) Operations on specially prepared winter runways .....</b>	<b>431</b>
<b>AMC1 ADR.OPS.B.036(c) Operations on specially prepared winter runways .....</b>	<b>431</b>
<b>GM1 ADR.OPS.B.036(c) Operations on specially prepared winter runways .....</b>	<b>431</b>
<b>ADR.OPS.B.037 Assessment of runway surface condition and assignment of runway condition code.....</b>	<b>432</b>
<b>AMC1 ADR.OPS.B.037(a) Assessment of runway surface condition and assignment of runway condition code .....</b>	<b>432</b>
<b>GM1 ADR.OPS.B.037(a) Assessment of runway surface condition and assignment of runway condition code .....</b>	<b>434</b>
<b>GM2 ADR.OPS.B.037(a) Assessment of runway surface condition and assignment of runway condition code .....</b>	<b>436</b>
<b>AMC1 ADR.OPS.B.037(a);(b) Assessment of runway surface condition and assignment of runway condition code .....</b>	<b>436</b>
<b>GM1 ADR.OPS.B.037(b) Assessment of runway surface condition and assignment of runway condition code .....</b>	<b>437</b>
<b>GM2 ADR.OPS.B.037(b) Assessment of runway surface condition and assignment of runway condition code .....</b>	<b>438</b>
<b>AMC1 ADR.OPS.B.037(c) Assessment of runway surface condition and assignment of runway condition code .....</b>	<b>439</b>
<b>GM1 ADR.OPS.B.037(c) Assessment of runway surface condition and assignment of runway condition code .....</b>	<b>440</b>
<b>ADR.OPS.B.040 Night operations .....</b>	<b>440</b>
<b>AMC1 ADR.OPS.B.040 Night Operations .....</b>	<b>440</b>
<b>ADR.OPS.B.045 Low visibility operations .....</b>	<b>440</b>
<b>AMC1 ADR.OPS.B.045 Low visibility operations .....</b>	<b>440</b>
<b>ADR.OPS.B.050 Operations in adverse weather conditions .....</b>	<b>441</b>
<b>AMC1 ADR.OPS.B.050 Operations in adverse weather conditions.....</b>	<b>441</b>

<b>ADR.OPS.B.055 Fuel quality .....</b>	<b>441</b>
<b>AMC1 ADR.OPS.B.055 Fuel quality .....</b>	<b>442</b>
<b>GM1 ADR.OPS.B.055 Fuel quality .....</b>	<b>442</b>
<b>ADR.OPS.B.065 Visual aids and aerodrome electrical systems .....</b>	<b>442</b>
<b>AMC1 ADR.OPS.B.065 Visual aids and aerodrome electrical systems .....</b>	<b>442</b>
<b>GM1 ADR.OPS.B.065 Visual aids and aerodrome electrical systems .....</b>	<b>443</b>
<b>ADR.OPS.B.070 Aerodrome works safety .....</b>	<b>443</b>
<b>AMC1 ADR.OPS.B.070 Aerodrome works safety .....</b>	<b>443</b>
<b>AMC2 ADR.OPS.B.070 Aerodrome works safety .....</b>	<b>444</b>
<b>AMC3 ADR.OPS.B.070 Aerodrome works safety .....</b>	<b>444</b>
<b>AMC4 ADR.OPS.B.070 Aerodrome works safety .....</b>	<b>445</b>
<b>GM1 ADR.OPS.B.070 Aerodrome works safety .....</b>	<b>445</b>
<b>GM2 ADR.OPS.B.070 Aerodrome works safety .....</b>	<b>445</b>
<b>GM3 ADR.OPS.B.070 Aerodrome works safety .....</b>	<b>446</b>
<b>GM4 ADR.OPS.B.070 Aerodromes works safety .....</b>	<b>447</b>
<b>GM5 ADR.OPS.B.070 Aerodrome works safety .....</b>	<b>447</b>
<b>GM6 ADR.OPS.B.070 Aerodrome works safety .....</b>	<b>448</b>
<b>ADR.OPS.B.075 Safeguarding of aerodromes .....</b>	<b>448</b>
<b>AMC1 ADR.OPS.B.075 Safeguarding of aerodromes .....</b>	<b>448</b>
<b>GM1 ADR.OPS.B.075(a)(1) Safeguarding of aerodromes .....</b>	<b>449</b>
<b>GM2 ADR.OPS.B.075(a)(1) Safeguarding of aerodromes .....</b>	<b>449</b>
<b>ADR.OPS.B.080 Marking and lighting of vehicles and other mobile objects .....</b>	<b>449</b>
<b>AMC1 ADR.OPS.B.080(a) Marking and lighting of vehicles and other mobile objects .....</b>	<b>450</b>
<b>AMC2 ADR.OPS.B.080(a) Marking and lighting of vehicles and other mobile objects .....</b>	<b>451</b>
<b>GM1 ADR.OPS.B.080(a) Marking and lighting of vehicles and other mobile objects .....</b>	<b>451</b>
<b>ADR.OPS.B.090 Use of the aerodrome by higher code letter aircraft .....</b>	<b>451</b>
<b>AMC1 ADR.OPS.B.090 Use of the aerodrome by higher code letter aircraft .....</b>	<b>452</b>
<b>GM1 ADR.OPS.B.090 Use of the aerodrome by higher code letter aircraft .....</b>	<b>452</b>
<b>SUBPART C — AERODROME MAINTENANCE (ADR.OPS.C) .....</b>	<b>454</b>
<b>ADR.OPS.C.005 Maintenance — General .....</b>	<b>454</b>
<b>AMC1 ADR.OPS.C.005 General .....</b>	<b>454</b>
<b>GM1 ADR.OPS.C.005 General .....</b>	<b>454</b>
<b>ADR.OPS.C.007 Maintenance of vehicles .....</b>	<b>455</b>
<b>AMC1 ADR.OPS.C.007(a) Maintenance of vehicles .....</b>	<b>455</b>
<b>AMC1 ADR.OPS.C.007(a)(1) Maintenance of vehicles .....</b>	<b>456</b>
<b>GM1 ADR.OPS.C.007(a)(2) Maintenance of vehicles .....</b>	<b>456</b>
<b>AMC1 ADR.OPS.C.007(b)(1) Maintenance of vehicles .....</b>	<b>456</b>
<b>AMC1 ADR.OPS.C.007(b)(2) Maintenance of vehicles .....</b>	<b>457</b>
<b>AMC1 ADR.OPS.C.007(b)(3) Maintenance of vehicles .....</b>	<b>457</b>
<b>AMC1 ADR.OPS.C.007(c) Maintenance of vehicles .....</b>	<b>457</b>
<b>AMC2 ADR.OPS.C.007(c) Maintenance of vehicles .....</b>	<b>458</b>
<b>GM1 ADR.OPS.C.007(d) Maintenance of vehicles .....</b>	<b>458</b>
<b>ADR.OPS.C.010 Maintenance of pavements, other ground surfaces and drainage .....</b>	<b>458</b>

AMC1 ADR.OPS.C.010 Maintenance of pavements, other ground surfaces and drainage .....	459
GM1 ADR.OPS.C.010(b)(1) Pavements, other ground surfaces, and drainage .....	459
GM1 ADR.OPS.C.010(b)(2) Pavements, other ground surfaces and drainage .....	460
AMC1 ADR.OPS.C.010(b)(3) Maintenance of pavements, other ground surfaces and drainage .....	462
GM1 ADR.OPS.C.010(b)(3) Pavements, other ground surfaces and drainage .....	463
AMC1 ADR.OPS.C.010(b)(4) Maintenance of pavements, other ground surfaces and drainage .....	463
AMC2 ADR.OPS.C.010(b)(4) Maintenance of pavements, other ground surfaces and drainage .....	464
AMC3 ADR.OPS.C.010(b)(4) Maintenance of pavements, other ground surfaces and drainage .....	464
AMC4 ADR.OPS.C.010(b)(4) Maintenance of pavements, other ground surfaces and drainage .....	464
GM1 ADR.OPS.C.010(b)(4) Maintenance of pavements, other ground surfaces and drainage .....	465
GM2 ADR.OPS.C.010(b)(4) Maintenance of pavements, other ground surfaces and drainage .....	465
<b>ADR.OPS.C.015 Maintenance of visual aids and electrical systems.....</b>	<b>468</b>
AMC1 ADR.OPS.C.015(a);(f) Maintenance of visual aids and electrical systems.....	470
GM1 ADR.OPS.C.015(a);(f) Maintenance of visual aids and electrical systems.....	470
GM2 ADR.OPS.C.015(a);(f) Maintenance of visual aids and electrical systems.....	471
GM1 ADR.OPS.C.015(b) Maintenance of visual aids and electrical systems .....	471
GM2 ADR.OPS.C.015(b) Maintenance of visual aids and electrical systems .....	472
GM3 ADR.OPS.C.015(b) Maintenance of visual aids and electrical systems .....	472
GM1 ADR.OPS.C.015(b);(c) Maintenance of visual aids and electrical systems .....	473
AMC1 ADR.OPS.C.015(b);(f) Maintenance of visual aids and electrical systems.....	473
GM1 ADR.OPS.C.015(b);(f) Maintenance of visual aids and electrical systems .....	474
AMC1 ADR.OPS.C.015(d) Maintenance of visual aids and electrical systems .....	476
GM1 ADR.OPS.C.015(d) Maintenance of visual aids and electrical systems .....	476
AMC1 ADR.OPS.C.015(d);(f) Maintenance of visual aids and electrical systems.....	477
GM1 ADR.OPS.C.015(d);(f) Maintenance of visual aids and electrical systems .....	478
<b>SUBPART D — APRON MANAGEMENT OPERATIONS .....</b>	<b>479</b>
<b>ADR.OPS.D.001 Apron management safety related activities.....</b>	<b>479</b>
<b>ADR.OPS.D.005 Apron boundaries .....</b>	<b>479</b>
AMC1 ADR.OPS.D.005 Apron boundaries.....	480
<b>ADR.OPS.D.010 Coordination of aircraft entry to/exit from the apron .....</b>	<b>480</b>
AMC1 ADR.OPS.D.010(a)(2);(b)(2) Coordination of aircraft entry to / exit from the apron.....	480
<b>ADR.OPS.D.015 Management of aircraft movements on the apron .....</b>	<b>481</b>
AMC1 ADR.OPS.D.015(a) Management of aircraft movements on the apron .....	481
GM1 ADR.OPS.D.015(b) Management of aircraft movements on the apron .....	481
AMC1 ADR.OPS.D.015(c) Management of aircraft movement on the apron .....	481
<b>ADR.OPS. D.025 Aircraft stand allocation.....</b>	<b>482</b>
GM1 ADR.OPS.D.025 Aircraft stand allocation .....	482



AMC1 ADR.OPS.D.025(a)(3) Aircraft stand allocation .....	482
GM1 ADR.OPS.D.025(b)(1) Aircraft stand allocation .....	483
GM1 ADR.OPS.D.025(b)(2) Aircraft stand allocation .....	484
GM1 ADR.OPS.D.025(b)(3) Aircraft stand allocation .....	484
<b>ADR.OPS.D.030 Marshalling of aircraft.....</b>	<b>485</b>
<b>ADR.OPS.D.035 Aircraft parking .....</b>	<b>485</b>
AMC1 ADR.OPS.D.035(a) Aircraft parking .....	485
AMC1 ADR.OPS.D.035(b) Aircraft parking .....	485
AMC2 ADR.OPS.D.035(b) Aircraft parking .....	486
AMC3 ADR.OPS.D.035(b) Aircraft parking .....	486
AMC1 ADR.OPS.D.035(c) Aircraft parking .....	486
<b>ADR.OPS.D.040 Aircraft departure from the stand .....</b>	<b>487</b>
GM1 ADR.OPS.D.040 Aircraft departure from the stand .....	487
GM1 ADR.OPS.D.040(e) Aircraft departure from the stand .....	487
<b>ADR.OPS.D.045 Dissemination of information to organisations operating at the apron .....</b>	<b>487</b>
GM1 ADR.OPS.D.045 Dissemination of information to organisations operating at the apron.....	488
<b>ADR.OPS.D.050 Alerting of emergency services .....</b>	<b>488</b>
AMC1 ADR.OPS.D.050(a)(2) Alerting of emergency services.....	489
GM1 ADR.OPS.D.050(a)(2) Alerting of emergency services .....	489
<b>ADR.OPS.D.055 Jet blast precautions .....</b>	<b>489</b>
AMC1 ADR.OPS.D.055(a) Jet blast precautions .....	489
AMC1 ADR.OPS.D.055(d) Jet blast precautions .....	490
<b>ADR.OPS.D.060 Aircraft refuelling.....</b>	<b>490</b>
<b>ADR.OPS.D.065 Engine test .....</b>	<b>490</b>
GM1 ADR.OPS.D.065 Engine test .....	491
<b>ADR.OPS.D.070 High-visibility clothing.....</b>	<b>491</b>
<b>ADR.OPS.D.075 Start-up clearances and taxi instructions .....</b>	<b>491</b>
<b>ADR.OPS.D.080 Training and proficiency check programmes of marshallers and “FOLLOW-ME” drivers.....</b>	<b>491</b>
AMC1 ADR.OPS.D.080(a)(1);(2) Training and proficiency check programme of marshallers and ‘FOLLOW-ME’ drivers .....	492
AMC1 ADR.OPS.D.080(a)(2);(b)(2)(i) Training and proficiency check programme of marshallers and ‘FOLLOW-ME’ drivers .....	493
<b>ADR.OPS.D.085 Training and proficiency check programme of personnel providing taxi instructions to aircraft through radiotelephony .....</b>	<b>493</b>
AMC1 ADR.OPS.D.085(a)(2)(i) Training and proficiency check programme of personnel providing taxi instructions to aircraft through radiotelephony .....	495
AMC1 ADR.OPS.D.085(a)(2)(ii) Training and proficiency check programme of personnel providing taxi instructions to aircraft through radiotelephony .....	497
AMC1 ADR.OPS.D.085(f) Training and proficiency check programme of personnel providing taxi instructions to aircraft through radiotelephony .....	497

---

AMC2 ADR.OPS.D.085(f) Training and proficiency check programme of personnel providing taxi instructions to aircraft through radiotelephony.....	498
AMC3 ADR.OPS.D.085(f) Training and proficiency check programme of personnel providing taxi instructions to aircraft through radiotelephony.....	498
AMC4 ADR.OPS.D.085(f) Training and proficiency check programme of personnel providing taxi instructions to aircraft through radiotelephony.....	499
GM1 ADR.OPS.D.085(f) Training and proficiency check programme of personnel providing taxi instructions to aircraft through radiotelephony.....	499
GM2 ADR.OPS.D.085(f) Training and proficiency check programme of personnel providing taxi instructions to aircraft through radiotelephony.....	501
GM3 ADR.OPS.D.085(f) Training and proficiency check programme of personnel providing taxi instructions to aircraft through radiotelephony.....	501
AMC1 ADR.OPS.D.085(g) Training and proficiency check programme of personnel providing taxi instructions to aircraft through radiotelephony.....	501
GM1 ADR.OPS.D.085(g) Training and proficiency check programme of personnel providing taxi instructions to aircraft through radiotelephony.....	501
<b>CS-ADR-DSN — Issue 5 .....</b>	<b>503</b>
<b>Preamble.....</b>	<b>503</b>
<b>List of abbreviations .....</b>	<b>512</b>
<b>CHAPTER A — GENERAL .....</b>	<b>514</b>
CS ADR-DSN.A.001 Applicability.....	514
GM1 ADR-DSN.A.001 Applicability.....	514
CS ADR-DSN.A.002 Definitions .....	514
GM1 ADR-DSN.A.002 Definitions .....	521
CS ADR-DSN.A.005 Aerodrome reference code (ARC).....	521
GM1 ADR-DSN.A.005 Aerodrome reference code (ARC).....	521
CS ADR-DSN.A.010 .....	522
GM1 ADR-DSN.A.010.....	522
<b>CHAPTER B — RUNWAYS.....</b>	<b>523</b>
CS ADR-DSN.B.015 Number, siting and orientation of runways.....	523
GM1 ADR-DSN.B.015 Number, siting, and orientation of runways .....	523
CS ADR-DSN.B.020 Choice of maximum permissible crosswind components.....	525
GM1 ADR-DSN.B.020 Choice of maximum permissible crosswind components .....	525
CS ADR-DSN.B.025 Data to be used .....	525
GM1 ADR-DSN.B.025 Data to be used .....	525
CS ADR-DSN.B.030 Runway threshold .....	525
GM1 ADR-DSN.B.030 Runway threshold .....	526
CS ADR-DSN.B.035 Length of runway and declared distances .....	527
GM1 ADR-DSN.B.035 Length of the runway and declared distances.....	527
CS ADR-DSN.B.040 Runways with stopways or clearways .....	529

GM1 ADR-DSN.B.040 Runways with stopways, or clearways .....	529
CS ADR-DSN.B.045 Width of runways.....	529
GM1 ADR-DSN.B.045 Width of runways .....	529
CS ADR-DSN.B.050 Minimum distance between parallel non-instrument runways .....	530
GM1 ADR-DSN.B.050 Minimum distance between parallel non-instrument runways .....	530
CS ADR-DSN.B.055 Minimum distance between parallel instrument runways ..	530
GM1 ADR-DSN.B.055 Minimum distance between parallel instrument runways .....	531
CS ADR-DSN.B.060 Longitudinal slopes of runways .....	531
GM1 ADR-DSN.B.060 Longitudinal slopes on runways .....	531
CS ADR-DSN.B.065 Longitudinal slope changes on runways .....	531
GM1 ADR-DSN.B.065 Longitudinal slopes changes on runways .....	532
CS ADR-DSN.B.070 Sight distance for slopes on runways .....	532
GM1 ADR-DSN.B.070 Sight distance for slopes of runways .....	532
CS ADR-DSN.B.075 Distance between slope changes on runways .....	533
GM1 ADR-DSN.B.075 Distance between slope changes on runways.....	533
CS ADR-DSN.B.080 Transverse slopes on runways.....	534
GM1 ADR-DSN.B.080 Transverse slopes on runways.....	534
CS ADR-DSN.B.085 Runway strength.....	534
GM1 ADR-DSN.B.085 Runway strength.....	535
CS ADR-DSN.B.090 Surface of runways.....	535
GM1 ADR-DSN.B.090 Surface of runways.....	536
CS ADR-DSN.B.095 Runway turn pads .....	536
GM1 ADR-DSN.B.095 Runway turn pads .....	537
CS ADR-DSN.B.100 Slopes on runway turn pads .....	537
GM1 ADR-DSN.B.100 Slopes on runway turn pads .....	537
CS ADR-DSN.B.105 Strength of runway turn pads .....	537
GM1 ADR-DSN.B.105 Strength of runway turn pads.....	538
CS ADR-DSN.B.110 Surface of runway turn pads .....	538
GM1 ADR-DSN.B.110 Surface of runway turn pads .....	538
CS ADR-DSN.B.115 Width of shoulders for runway turn pads.....	538
GM1 ADR-DSN.B.115 Width of shoulders for runway turn pads.....	538
CS ADR-DSN.B.120 Strength of shoulders for runway turn pads.....	538
GM1 ADR-DSN.B.120 Strength of shoulders for runway turn pads .....	538
CS ADR-DSN.B.125 Runway shoulders.....	538
GM1 ADR-DSN.B.125 Runway shoulders.....	539
CS ADR-DSN.B.130 Slopes on runway shoulders.....	539
GM1 ADR-DSN.B.130 Slopes on runway shoulders.....	539
CS ADR-DSN.B.135 Width of runway shoulders .....	539

---

GM1 ADR-DSN.B.135 Width of runway shoulders .....	540
CS ADR-DSN.B.140 Strength of runway shoulders .....	540
GM1 ADR-DSN.B.140 Strength of runway shoulders .....	540
CS ADR-DSN.B.145 Surface of runway shoulders .....	541
GM1 ADR-DSN.B.145 Surface of runway shoulders .....	541
CS ADR-DSN.B.150 Runway strip to be provided .....	541
GM1 ADR-DSN.B.150 Runway strip to be provided .....	542
CS ADR-DSN.B.155 Length of runway strip .....	542
GM1 ADR-DSN.B.155 Length of runway strip .....	542
CS ADR-DSN.B.160 Width of runway strip .....	542
GM1 ADR-DSN.B.160 Width of runway strip .....	543
CS ADR-DSN.B.165 Objects on runway strips.....	543
GM1 ADR-DSN.B.165 Objects on runway strips.....	543
CS ADR-DSN.B.170 .....	544
GM1 ADR-DSN.B.170 .....	544
CS ADR-DSN.B.175 Grading of runway strips .....	544
GM1 ADR-DSN.B.175 Grading of runway strips .....	545
CS ADR-DSN.B.180 Longitudinal slopes on runway strips .....	545
GM1 ADR-DSN.B.180 Longitudinal Slopes on runway strips .....	546
CS ADR-DSN.B.185 Transverse slopes on runway strips.....	546
GM1 ADR-DSN.B.185 Transverse slopes on runway strips.....	546
CS ADR-DSN.B.190 Strength of runway strips.....	546
GM1 ADR-DSN.B.190 Strength of runway strips.....	547
CS ADR-DSN.B.191 Drainage characteristics of the movement area and adjacent areas .....	547
GM1 ADR-DSN.B.191 Drainage characteristics of the movement area and adjacent areas .....	547
CS ADR-DSN.B.195 Clearways.....	549
GM1 ADR-DSN.B.195 Clearways .....	550
CS ADR-DSN.B.200 Stopways .....	552
GM1 ADR-DSN.B.200 Stopways .....	552
CS ADR-DSN.B.205 Radio altimeter operating area .....	553
GM1 ADR-DSN.B.205 Radio altimeter operating area .....	553
<b>CHAPTER C — RUNWAY END SAFETY AREA .....</b>	<b>554</b>
CS ADR-DSN.C.210 Runway end safety areas (RESA) .....	554
GM1 ADR-DSN.C.210 Runway end safety areas (RESA) .....	554
CS ADR-DSN.C.215 Dimensions of runway end safety areas .....	558
GM1 ADR-DSN.C.215 Dimensions of runway end safety areas .....	558
CS ADR-DSN.C.220 Objects on runway end safety areas.....	559

---

GM1 ADR-DSN.C.220 Objects on runway end safety areas .....	559
CS ADR-DSN.C.225 Clearing and grading of runway end safety areas .....	559
GM1 ADR-DSN.C.225 Clearing and grading of runway end safety areas .....	559
CS ADR-DSN.C.230 Slopes on runway end safety areas .....	559
GM1 ADR-DSN.C.230 Slopes on runway end safety areas .....	559
CS ADR-DSN.C.235 Strength of runway end safety areas .....	560
GM1 ADR-DSN.C.235 Strength of runway end safety areas .....	560
<b>CHAPTER D — TAXIWAYS .....</b>	<b>561</b>
CS ADR-DSN.D.240 Taxiways general .....	561
GM1 ADR-DSN.D.240 Taxiways general .....	561
CS ADR-DSN.D.245 Width of taxiways .....	564
GM1 ADR-DSN.D.245 Width of taxiways .....	564
CS ADR-DSN.D.250 Taxiways curves .....	564
GM1 ADR-DSN.D.250 Taxiways curves .....	564
CS ADR-DSN.D.255 Junction and intersection of taxiways .....	565
GM1 ADR-DSN.D.255 Junction and intersection of taxiways .....	565
CS ADR-DSN.D.260 Taxiway minimum separation distance .....	566
GM1 ADR-DSN.D.260 Taxiway minimum separation distance .....	567
CS ADR-DSN.D.265 Longitudinal slopes on taxiways .....	567
GM1 ADR-DSN.D.265 Longitudinal slopes on taxiways .....	567
CS ADR-DSN.D.270 Longitudinal slope changes on taxiways .....	568
GM1 ADR-DSN.D.270 Longitudinal slope changes on taxiways .....	568
CS ADR-DSN.D.275 Sight distance of taxiways .....	568
GM1 ADR-DSN.D.275 Sight distance of taxiways .....	568
CS ADR-DSN.D.280 Transverse slopes on taxiways .....	568
GM1 ADR-DSN.D.280 Transverse slopes on taxiways .....	569
CS ADR-DSN.D.285 Strength of taxiways .....	569
GM1 ADR-DSN.D.285 Strength of taxiways .....	569
CS ADR-DSN.D.290 Surface of taxiways .....	569
GM1 ADR-DSN.D.290 Surface of taxiways .....	569
CS ADR-DSN.D.295 Rapid exit taxiways .....	569
GM1 ADR-DSN.D.295 Rapid exit taxiways .....	570
CS ADR-DSN.D.300 Taxiways on bridges .....	571
GM1 ADR-DSN.D.300 Taxiways on bridges .....	571
CS ADR-DSN.D.305 Taxiway shoulders .....	571
GM1 ADR-DSN.D.305 Taxiway shoulders .....	571
CS ADR-DSN.D.310 Taxiway Strip .....	571
GM1 ADR-DSN.D.310 Taxiway Strip .....	572
CS ADR-DSN.D.315 Width of taxiway strips .....	572

---

GM1 ADR-DSN.D.315 Width of taxiway strips .....	572
CS ADR-DSN.D.320 Objects on taxiway strips .....	572
GM1 ADR-DSN.D.320 Objects on taxiway strips .....	572
CS ADR-DSN.D.325 Grading of taxiway strips .....	573
GM1 ADR-DSN.D.325 Grading of taxiway strips .....	573
CS ADR-DSN.D.330 Slopes on taxiway strips.....	573
GM1 ADR-DSN.D.330 Slopes on taxiway strips.....	574
CS ADR-DSN.D.335 Holding bays, runway-holding positions, intermediate holding positions, and road-holding positions .....	574
GM1 ADR-DSN.D.335 Holding bays, runway-holding positions, intermediate holding positions, and road-holding positions .....	574
CS ADR-DSN.D.340 Location of holding bays, runway-holding positions, intermediate holding positions, and road-holding positions .....	575
GM1 ADR-DSN.D.340 Location of holding bays, runway-holding positions, intermediate holding positions, and road-holding positions.....	576
<b>CHAPTER E — APRONS .....</b>	<b>578</b>
CS ADR-DSN.E.345 General .....	578
GM1 ADR-DSN.E.345 General .....	578
CS ADR-DSN.E.350 Size of aprons .....	578
GM1 ADR-DSN.E.350 Size of aprons .....	578
CS ADR-DSN.E.355 Strength of aprons.....	579
GM1 ADR-DSN.E.355 Strength of aprons.....	579
CS ADR-DSN.E.360 Slopes on aprons .....	579
GM1 ADR-DSN.E.360 Slopes on aprons .....	579
CS ADR-DSN.E.365 Clearance distances on aircraft stands.....	580
GM1 ADR-DSN.E.365 Clearance distances on aircraft stands.....	580
<b>CHAPTER F — ISOLATED AIRCRAFT PARKING POSITION.....</b>	<b>582</b>
CS ADR-DSN.F.370 Isolated aircraft parking position.....	582
GM1 ADR-DSN.F.370 Isolated aircraft parking position .....	582
<b>CHAPTER G — DE-ICING/ANTI-ICING FACILITIES .....</b>	<b>583</b>
CS ADR-DSN.G.375 General .....	583
GM1 ADR-DSN.G.375 General.....	583
CS ADR-DSN.G.380 Location .....	583
GM1 ADR-DSN.G.380 Location.....	583
CS ADR-DSN.G.385 Size of de-icing/anti-icing pads .....	584
GM1 ADR-DSN.G.385 Size of de-icing/anti-icing pads.....	584
CS ADR-DSN.G.390 Slopes on de-icing/anti-icing pads.....	584
GM1 -ADR-DSN.G.390 Slopes on de-icing/anti-icing pads.....	584
CS ADR-DSN.G.395 Strength of de-icing/anti-icing pads .....	585

---

GM1 ADR-DSN.G.395 Strength of de-icing/anti-icing pads .....	585
CS ADR-DSN.G.400 Clearance distances on a de-icing/anti-icing pad.....	585
GM1 ADR-DSN.G.400 Clearance distances on a de-icing/anti-icing pad .....	586
<b>CHAPTER H — OBSTACLE LIMITATION SURFACES .....</b>	<b>587</b>
CS ADR-DSN.H.405 Applicability.....	587
GM1 ADR-DSN.H.405 Applicability.....	587
CS ADR-DSN.H.410 Outer horizontal surface .....	588
GM1 ADR-DSN.H.410 Outer horizontal surface .....	588
CS ADR-DSN.H.415 Conical surface.....	589
GM1 ADR-DSN.H.415 Conical surface.....	589
CS ADR-DSN.H.420 Inner horizontal surface .....	590
GM1 ADR-DSN.H.420 Inner horizontal surface .....	590
CS ADR-DSN.H.425 Approach surface .....	591
GM1 ADR-DSN.H.425 Approach surface .....	592
CS ADR-DSN.H.430 Transitional surface .....	592
GM1 ADR-DSN.H.430 Transitional surface .....	595
CS ADR-DSN.H.435 Take-off climb surface.....	595
GM1 ADR-DSN.H.435 Take-off climb surface.....	596
CS ADR-DSN.H.440 Slew ed take-off climb surface .....	596
GM1 ADR-DSN.H.440 Slew ed take-off climb surface .....	596
CS ADR-DSN.H.445 Obstacle-free zone (OFZ).....	596
GM1 ADR-DSN.H.445 Obstacle-free zone (OFZ).....	597
CS ADR-DSN.H.450 Inner approach surface .....	597
GM1 ADR-DSN.H.450 Inner approach surface .....	597
CS ADR-DSN.H.455 Inner transitional surface.....	597
GM1 ADR-DSN.H.455 Inner transitional surface .....	598
CS ADR-DSN.H.460 Balked landing surface .....	598
GM1 ADR-DSN.H.460 Balked landing surface .....	598
<b>CHAPTER J — OBSTACLE LIMITATION REQUIREMENTS .....</b>	<b>599</b>
CS ADR-DSN.J.465 General .....	599
GM1 ADR-DSN.J.465 General .....	599
CS ADR-DSN.J.470 Non-instrument runways .....	599
GM1 ADR-DSN.J.470 Non-instrument runways .....	600
CS ADR-DSN.J.475 Non-precision approach runways.....	600
GM1 ADR-DSN.J.475 Non-precision approach runways.....	601
CS ADR-DSN.J.480 Precision approach runways .....	601
GM1 ADR-DSN.J.480 Precision approach runways .....	604
CS ADR-DSN.J.485 Runways meant for take-off.....	604
GM1 ADR-DSN.J.485 Runways meant for take-off.....	605

---

CS ADR-DSN.J.486 Other objects .....	606
GM1 ADR-DSN.J.486 Other objects .....	606
CS ADR-DSN.J.487 Objects outside the obstacle limitation surfaces .....	606
GM1 ADR-DSN.J.487 Objects outside the obstacle limitation surfaces .....	607
<b>CHAPTER K — VISUAL AIDS FOR NAVIGATION (INDICATORS AND SIGNALLING DEVICES) .....</b>	<b>608</b>
CS ADR-DSN.K.490 Wind direction indicator .....	608
GM1 ADR-DSN.K.490 Wind direction indicator .....	608
CS ADR-DSN.K.495 Landing direction indicator.....	609
GM1 ADR-DSN.K.495 Landing direction indicator.....	610
CS ADR-DSN.K.500 Signalling lamp.....	610
GM1 ADR-DSN.K.500 Signalling lamp.....	611
CS ADR-DSN.K.505 Signal panels and signal area.....	611
GM1 ADR-DSN.K.505 Signal panels and signal area.....	611
CS ADR-DSN.K.510 Location of signal panels and signal area.....	611
GM1 ADR-DSN.K.510 Location of signal panels and signal area.....	611
CS ADR-DSN.K.515 Characteristics of signal panels and signal area .....	611
GM1 ADR-DSN.K.515 Characteristics of signal panels and signal area .....	611
<b>CHAPTER L — VISUAL AIDS FOR NAVIGATION (MARKINGS).....</b>	<b>613</b>
CS ADR-DSN.L.520 General — Colour and conspicuity.....	613
GM1 ADR-DSN.L.520 General – Colour and conspicuity.....	613
CS ADR-DSN.L.525 Runway designation marking.....	613
GM1 ADR-DSN.L.525 Runway designation marking.....	615
CS ADR-DSN.L.530 Runway centre line marking .....	615
GM1 ADR-DSN.L.530 Runway centre line marking .....	616
CS ADR-DSN.L.535 Threshold marking.....	616
GM1 ADR-DSN.L.535 Threshold marking.....	618
CS ADR-DSN.L.540 Aiming point marking .....	618
GM1 ADR-DSN.L.540 Aiming point marking .....	619
CS ADR-DSN.L.545 Touchdown zone marking.....	619
GM1 ADR-DSN.L.545 Touchdown zone marking.....	621
CS ADR-DSN.L.550 Runway side stripe marking.....	621
GM1 ADR-DSN.L.550 Runway side stripe marking.....	621
CS ADR-DSN.L.555 Taxiway centre line marking .....	623
GM1 ADR-DSN.L.555 Taxiway centre line marking .....	624
CS ADR-DSN.L.560 Interruption of runway markings.....	625
GM1 ADR-DSN.L.560 Interruption of runway markings .....	625
CS ADR-DSN.L.565 Runway turn pad marking .....	626
GM1 ADR-DSN.L.565 Runway turn pad marking .....	627



---

CS ADR-DSN.L.570 Enhanced taxiway centre line marking .....	627
GM1 ADR-DSN.L.570 Enhanced taxiway centre line marking.....	628
CS ADR-DSN.L.575 Runway-holding position marking .....	629
GM1 ADR-DSN.L.575 Runway-holding position marking .....	630
CS ADR-DSN.L.580 Intermediate holding position marking.....	630
GM1 ADR-DSN.L.580 Intermediate holding position marking.....	631
CS ADR-DSN.L.585 VOR aerodrome checkpoint marking .....	631
GM1 ADR-DSN.L.585 VOR aerodrome checkpoint marking .....	632
CS ADR-DSN.L.590 Aircraft stand marking .....	632
GM1 ADR-DSN.L.590 Aircraft stand marking .....	633
CS ADR-DSN.L.595 Apron safety lines .....	633
GM1 ADR-DSN.L.595 Apron safety lines.....	634
CS ADR-DSN.L.597 Apron service road marking.....	634
GM1 ADR-DSN.L.597 Apron service road marking.....	635
CS ADR-DSN.L.600 Road-holding position marking .....	635
GM1 ADR-DSN.L.600 Road-holding position marking .....	635
CS ADR-DSN.L.605 Mandatory instruction marking .....	636
GM1 ADR-DSN.L.605 Mandatory instruction marking .....	637
CS ADR-DSN.L.610 Information marking.....	638
GM1 ADR-DSN.L.610 Information marking.....	643
<b>CHAPTER M — VISUAL AIDS FOR NAVIGATION (LIGHTS) .....</b>	<b>644</b>
CS ADR-DSN.M.615 General .....	644
GM1 ADR-DSN.M.615 General.....	645
CS ADR-DSN.M.620 Aeronautical beacons.....	647
GM1 ADR-DSN.M.620 Aeronautical beacons .....	648
CS ADR-DSN.M.625 Approach lighting systems .....	648
GM1 ADR-DSN.M.625 Approach lighting systems .....	649
CS ADR-DSN.M.626 Simple approach lighting systems .....	655
GM1 ADR-DSN.M.626 Simple approach lighting systems .....	657
CS ADR-DSN.M.630 Precision approach Category I lighting system .....	658
GM1 ADR-DSN.M.630 Precision approach Category I lighting system.....	660
CS ADR-DSN.M.635 Precision approach Category II and III lighting system.....	660
GM1 ADR-DSN.M.635 Precision approach Category II and III lighting system .....	665
CS ADR-DSN.M.640 Visual approach slope indicator systems.....	665
GM1 ADR-DSN.M.640 Visual approach slope indicator systems .....	665
CS ADR-DSN.M.645 Precision approach path indicator and Abbreviated precision approach path indicator (PAPI and APAPI) .....	666
GM1 ADR-DSN.M.645 Precision approach path indicator and Abbreviated precision approach path indicator (PAPI and APAPI) .....	669

<b>CS ADR-DSN.M.650 Approach slope and elevation setting of light units for PAPI and APAPI .....</b>	<b>669</b>
<b>GM1 ADR-DSN.M.650 Approach slope and elevation setting of light units for PAPI and APAPI .....</b>	<b>670</b>
<b>CS ADR-DSN.M.655 Obstacle protection surface for PAPI and APAPI .....</b>	<b>671</b>
<b>GM1 ADR-DSN.M.655 Obstacle protection surface for PAPI and APAPI.....</b>	<b>673</b>
<b>CS ADR-DSN.M.660 Circling guidance lights.....</b>	<b>673</b>
<b>GM1 ADR-DSN.M.660 Circling guidance lights.....</b>	<b>674</b>
<b>CS ADR-DSN.M.665 Runway lead-in lighting systems .....</b>	<b>674</b>
<b>GM1 ADR-DSN.M.665 Runway lead-in lighting systems .....</b>	<b>675</b>
<b>CS ADR-DSN.M.670 Runway threshold identification lights.....</b>	<b>675</b>
<b>GM1 ADR-DSN.M.670 Runway threshold identification lights .....</b>	<b>676</b>
<b>CS ADR-DSN.M.675 Runway edge lights .....</b>	<b>676</b>
<b>GM1 ADR-DSN.M.675 Runway edge lights .....</b>	<b>677</b>
<b>CS ADR-DSN.M.680 Runway threshold and wing bar lights .....</b>	<b>677</b>
<b>GM1 ADR-DSN.M.680 Runway threshold and wing bar lights .....</b>	<b>678</b>
<b>CS ADR-DSN.M.685 Runway end lights.....</b>	<b>678</b>
<b>GM1 ADR-DSN.M.685 Runway end lights.....</b>	<b>681</b>
<b>CS ADR-DSN.M.690 Runway centre line lights .....</b>	<b>681</b>
<b>GM1 ADR-DSN.M.690 Runway centre line lights .....</b>	<b>682</b>
<b>CS ADR-DSN.M.695 Runway touchdown zone lights .....</b>	<b>683</b>
<b>GM1 ADR-DSN.M.695 Runway touchdown zone lights .....</b>	<b>683</b>
<b>CS ADR-DSN.M.696 Simple touchdown zone lights .....</b>	<b>683</b>
<b>GM1 ADR-DSN.M.696 Simple touchdown zone lights .....</b>	<b>685</b>
<b>CS ADR-DSN.M.700 Rapid exit taxiway indicator lights (RETILs) .....</b>	<b>685</b>
<b>GM1 ADR-DSN.M.700 Rapid exit taxiway indicator lights (RETILs) .....</b>	<b>685</b>
<b>CS ADR-DSN.M.705 Stopway lights .....</b>	<b>686</b>
<b>GM1 ADR-DSN.M.705 Stopway lights .....</b>	<b>687</b>
<b>CS ADR-DSN.M.706 Runway status lights (RWSL) .....</b>	<b>687</b>
<b>GM1 ADR-DSN.M.706 Runway status lights (RWSLs) .....</b>	<b>688</b>
<b>CS ADR-DSN.M.710 Taxiway centre line lights.....</b>	<b>688</b>
<b>GM1 ADR-DSN.M.710 Taxiway centre line lights.....</b>	<b>690</b>
<b>CS ADR-DSN.M.715 Taxiway centre line lights on taxiways, runways, rapid exit taxiways, or on other exit taxiways.....</b>	<b>690</b>
<b>GM1 ADR-DSN.M.715 Taxiway centre line lights on taxiways, runways, rapid exit taxiways, or on other exit taxiways .....</b>	<b>694</b>
<b>CS ADR-DSN.M.720 Taxiway edge lights.....</b>	<b>694</b>
<b>GM1 ADR-DSN.M.720 Taxiway edge lights.....</b>	<b>695</b>
<b>CS ADR-DSN.M.725 Runway turn pad lights .....</b>	<b>695</b>
<b>GM1 ADR-DSN.M.725 Runway turn pad lights .....</b>	<b>695</b>

---

CS ADR-DSN.M.730 Stop bars.....	696
GM1 ADR-DSN.M.730 Stop bars .....	697
CS ADR-DSN.M.735 Intermediate holding position lights .....	697
GM1 ADR-DSN.M.735 Intermediate holding position lights .....	698
CS ADR-DSN.M.740 De-icing/anti-icing facility exit lights .....	698
GM1 ADR-DSN.M.740 De-icing/anti-icing facility exit lights .....	699
CS ADR-DSN.M.745 Runway guard lights.....	699
GM1 ADR-DSN.M.745 Runway guard lights .....	701
CS ADR-DSN.M.750 Apron floodlighting .....	701
GM1 ADR-DSN.M.750 Apron floodlighting .....	702
CS ADR-DSN.M.755 Visual docking guidance system .....	702
GM1 ADR-DSN.M.755 Visual docking guidance system .....	703
CS ADR-DSN.M.760 Advanced visual docking guidance system .....	704
GM1 ADR-DSN.M.760 Advanced visual docking guidance system .....	705
CS ADR-DSN.M.765 Aircraft stand manoeuvring guidance lights .....	706
GM1 ADR-DSN.M.765 Aircraft stand manoeuvring guidance lights .....	706
CS ADR-DSN.M.770 Road-holding position light .....	706
GM1 ADR-DSN.M.770 Road-holding position light .....	707
CS ADR-DSN.M.771 No-entry bar .....	707
GM1 ADR-DSN.M.771 No-entry bar .....	708
<b>CHAPTER N — VISUAL AIDS FOR NAVIGATION (SIGNS).....</b>	<b>709</b>
CS ADR-DSN.N.775 General.....	709
GM1 ADR-DSN.N.775 General.....	722
CS ADR-DSN.N.780 Mandatory instruction signs .....	723
GM1 ADR-DSN.N.780 Mandatory instruction signs .....	725
CS ADR-DSN.N.785 Information signs.....	726
GM1 ADR-DSN.N.785 Information signs.....	729
CS ADR-DSN.N.790 VOR aerodrome checkpoint sign.....	730
GM1 ADR-DSN.N.790 VOR aerodrome checkpoint sign.....	731
CS ADR-DSN.N.795 Aircraft stand identification signs .....	731
GM1 ADR-DSN.N.795 Aircraft stand identification signs .....	731
CS ADR-DSN.N.800 Road-holding position sign.....	731
GM1 ADR-DSN.N.800 Road-holding position sign.....	732
<b>CHAPTER P — VISUAL AIDS FOR NAVIGATION (MARKERS) .....</b>	<b>733</b>
CS ADR-DSN.P.805 General .....	733
GM1 ADR-DSN.P.805 General .....	733
CS ADR-DSN.P.810 Unpaved runway edge markers.....	733
GM1 ADR-DSN.P.810 Unpaved runway edge markers.....	733
CS ADR-DSN.P.815 Stopway edge markers.....	733

---

GM1 ADR-DSN.P.815 Stopway edge markers .....	733
CS ADR-DSN.P.820 Edge markers for snow-covered runways .....	734
GM1 ADR-DSN.P.820 Edge markers for snow-covered runways .....	734
CS ADR-DSN.P.825 Taxiway edge markers.....	734
GM1 ADR-DSN.P.825 Taxiway edge markers.....	734
CS ADR-DSN.P.830 Taxiway centre line markers.....	735
GM1 ADR-DSN.P.830 Taxiway centre line markers.....	736
CS ADR-DSN.P.835 Unpaved taxiway edge markers .....	736
GM1 ADR-DSN.P.835 Unpaved taxiway edge markers .....	736
<b>CHAPTER Q — VISUAL AIDS FOR DENOTING OBSTACLES .....</b>	<b>737</b>
CS ADR-DSN.Q.840 Objects to be marked and/or lighted within the lateral boundaries of the obstacle limitation surfaces.....	737
GM1 ADR-DSN.Q.840 Objects to be marked and/or lighted within the lateral boundaries of the obstacle limitation surfaces.....	738
CS ADR-DSN.Q.841 Objects to be marked and/or lighted outside the lateral boundaries of the obstacle limitation surfaces.....	738
GM1 ADR-DSN.Q.841 Objects to be marked and/or lighted outside the lateral boundaries of the obstacle limitation surfaces.....	739
CS ADR-DSN.Q.845 Marking of fixed objects .....	739
GM1 ADR-DSN.Q.845 Marking of fixed objects .....	741
CS ADR-DSN.Q.846 Lighting of fixed objects.....	742
GM1 ADR-DSN.Q.846 Lighting of fixed objects.....	743
CS ADR-DSN.Q.847 Lighting of fixed objects with a height less than 45 m above ground level .....	751
GM1 ADR-DSN.Q.847 Lighting of fixed objects with a height less than 45 m above ground level .....	752
CS ADR-DSN.Q.848 Lighting of fixed objects with a height 45 m to a height less than 150 m above ground level .....	752
GM1 ADR-DSN.Q.848 Lighting of fixed objects with a height 45 m to a height less than 150 m above ground level.....	753
CS ADR-DSN.Q.849 Lighting of fixed objects with a height 150 m or more above ground level .....	753
GM1 ADR-DSN.Q.849 Lighting of fixed objects with a height 150 m or more above ground level .....	753
CS ADR-DSN.Q.850.....	754
GM1 ADR-DSN.Q.850.....	754
CS ADR-DSN.Q.851 Marking and lighting of wind turbines .....	754
GM1 ADR-DSN.Q.851 Marking and lighting of wind turbines .....	755
CS ADR-DSN.Q.852 Marking and lighting of overhead wires, cables, supporting towers, etc. ....	755

---

GM1 ADR-DSN.Q.852 Marking and lighting of overhead wires, cables, supporting towers, etc. ....	761
<b>CHAPTER R — VISUAL AIDS FOR DENOTING RESTRICTED USE AREAS..</b>	<b>762</b>
CS ADR-DSN.R.855 Closed runways and taxiways, or parts thereof .....	762
GM1 ADR-DSN.R.855 Closed runways and taxiways, or parts thereof .....	763
CS ADR-DSN.R.860 Non-load-bearing surfaces .....	763
GM1 ADR-DSN.R.860 Non-load-bearing surfaces .....	763
CS ADR-DSN.R.865 Pre-threshold area .....	764
GM1 ADR-DSN.R.865 Pre-threshold area .....	765
CS ADR-DSN.R.870 Unserviceable areas .....	765
GM1 ADR-DSN.R.870 Unserviceable areas .....	766
<b>CHAPTER S — ELECTRICAL SYSTEMS .....</b>	<b>767</b>
CS ADR-DSN.S.875 Electrical power supply systems for air navigation facilities	767
GM1 ADR-DSN.S.875 Electrical power supply systems for air navigation facilities ....	767
CS ADR-DSN.S.880 Electrical power supply systems .....	768
GM1 ADR-DSN.S.880 Electrical power supply.....	770
CS ADR-DSN.S.885 System design .....	770
GM1 ADR-DSN.S.885 System design .....	770
CS ADR-DSN.S.890 Monitoring .....	771
GM1 ADR-DSN.S.890 Monitoring .....	771
CS ADR-DSN.S.895 .....	771
GM1 ADR-DSN.S.895 .....	771
<b>CHAPTER T — AERODROME OPERATIONAL SERVICES, EQUIPMENT AND INSTALLATION .....</b>	<b>772</b>
CS ADR-DSN.T.900 Emergency access and service roads.....	772
GM1 ADR-DSN.T.900 Emergency access and service roads.....	772
CS ADR-DSN.T.905 Fire stations.....	773
GM1 ADR-DSN.T.905 Fire stations .....	774
CS ADR-DSN.T.910 Equipment frangibility requirements.....	774
GM1 ADR-DSN.T.910 Equipment frangibility requirements.....	774
CS ADR-DSN.T.915 Siting of equipment and installations on operational areas.	774
GM1 ADR-DSN.T.915 Siting of equipment and installations on operational areas ....	776
CS ADR-DSN.T.920 Fencing .....	776
GM1 ADR-DSN.T.920 Fencing.....	776
CS ADR-DSN.T.921 Autonomous runway incursion warning system (ARIWS) ....	777
GM1 ADR-DSN.T.921 Autonomous runway incursion warning system (ARIWS).....	778
<b>CHAPTER U — COLOURS FOR AERONAUTICAL GROUND LIGHTS, MARKINGS, SIGNS AND PANELS .....</b>	<b>781</b>

---

CS ADR-DSN.U.925 General .....	781
GM1 ADR-DSN.U.925 General.....	781
CS ADR-DSN.U.930 Colours for aeronautical ground lights .....	781
GM1 ADR-DSN.U.930 Colours for aeronautical ground lights .....	785
CS ADR-DSN.U.935 Colours for markings, signs and panels .....	786
GM1 ADR-DSN.U.935 Colours for markings, signs and panels .....	793
CS ADR-DSN.U.940 Aeronautical ground light characteristics.....	794
GM1 ADR-DSN.U.940 Aeronautical ground light characteristics .....	814
<b>CS-HPT-DSN — Issue 1 .....</b>	<b>815</b>
List of abbreviations .....	815
<b>CHAPTER A — GENERAL .....</b>	<b>816</b>
CS HPT-DSN.A.010 Applicability.....	816
GM1 HPT-DSN.A.010 Applicability.....	816
CS HPT-DSN.A.020 Definitions .....	816
GM1 HPT-DSN.A.020 Definitions.....	817
<b>CHAPTER B — HELICOPTER OPERATING AREAS .....</b>	<b>818</b>
CS HPT-DSN.B.100 Final approach and take-off areas (FATOs).....	818
GM1 HPT-DSN.B.100 Final approach and take-off areas (FATOs).....	819
CS HPT-DSN.B.110 Helicopter clearways.....	819
GM1 HPT-DSN.B.110 Helicopter clearways.....	820
CS HPT-DSN.B.120 Touchdown and lift-off areas (TLOFs).....	820
GM1 HPT-DSN.B.120 Touchdown and lift-off areas (TLOFs).....	820
CS HPT-DSN.B.130 Safety areas .....	820
GM1 HPT-DSN.B.130 Safety areas .....	821
<b>CHAPTER C — HELICOPTER TAXIWAYS AND TAXI-ROUTES.....</b>	<b>822</b>
CS HPT-DSN.C.200 Helicopter ground taxiways and helicopter ground taxi-routes .....	822
GM1 HPT-DSN.C.200 Helicopter ground taxiways and helicopter ground taxi-routes .....	823
CS HPT-DSN.C.210 Helicopter air taxiways and helicopter air taxi-routes .....	823
GM1 HPT-DSN.C.210 Helicopter air taxiways and helicopter air taxi-routes .....	825
<b>CHAPTER D — HELICOPTER STANDS .....</b>	<b>826</b>
CS HPT-DSN.D.300 Helicopter stands.....	826
GM1 HPT-DSN.D.300 Helicopter stands.....	828
<b>CHAPTER E — OBSTACLE LIMITATION SURFACES AND REQUIREMENTS .....</b>	<b>830</b>
CS HPT-DSN.E.400 Applicability .....	830

---

GM1 HPT-DSN.E.400	Applicability .....	830
CS HPT-DSN.E.410	Approach surface .....	830
GM1 HPT-DSN.E.410	Approach surface .....	834
CS HPT-DSN.E.420	Take-off climb surface .....	835
GM1 HPT-DSN.E.420	Take-off climb surface .....	836
CS HPT-DSN.E.430	Obstacle limitation requirements.....	837
GM1 HPT-DSN.E.430	Obstacle limitation requirements.....	837
<b>CHAPTER F — VISUAL AIDS.....</b>		<b>838</b>
CS HPT-DSN.F.500	General .....	838
GM1 HPT-DSN.F.500	General .....	838
CS HPT-DSN.F.510	Wind direction indicators .....	838
GM1 HPT-DSN.F.510	Wind direction indicators .....	838
CS HPT-DSN.F.520	Heliport identification marking .....	839
GM1 HPT-DSN.F.520	Heliport identification marking.....	841
CS HPT-DSN.F.530	Final approach and take-off area perimeter marking or markers.....	841
GM1 HPT-DSN.F.530	Final approach and take-off area perimeter marking or .....	842
CS HPT-DSN.F.540	Final approach and take-off area designation marking .....	842
GM1 HPT-DSN.F.540	Final approach and take-off area designation marking .....	843
CS HPT-DSN.F.550	Aiming point marking .....	843
GM1 HPT-DSN.F.550	Aiming point marking .....	844
CS HPT-DSN.F.560	Touchdown and lift-off area perimeter marking.....	844
GM1 HPT-DSN.F.560	Touchdown and lift-off area perimeter marking .....	844
CS HPT-DSN.F.570	Touchdown/positioning marking.....	844
GM1 HPT-DSN.F.570	Touchdown/positioning marking.....	845
CS HPT-DSN.F.580	Heliport name marking.....	845
GM1 HPT-DSN.F.580	Heliport name marking.....	845
CS HPT-DSN.F.590	Helicopter ground taxiway markings and markers.....	845
GM1 HPT-DSN.F.590	Helicopter ground taxiway markings and markers .....	846
CS HPT-DSN.F.600	Helicopter air taxiway markings and markers.....	846
GM1 HPT-DSN.F.600	Helicopter air taxiway markings and markers .....	847
CS HPT-DSN.F.610	Helicopter stand markings.....	848
GM1 HPT-DSN.F.610	Helicopter stand markings.....	850
CS HPT-DSN.F.620	Flight path alignment guidance marking.....	850
GM1 HPT-DSN.F.620	Flight path alignment guidance marking.....	851
CS HPT-DSN.F.630	Approach lighting system .....	851
GM1 HPT-DSN.F.630	Approach lighting system .....	852
CS HPT-DSN.F.640	Flight path alignment guidance lighting system.....	852

---

GM1 HPT-DSN.F.640	Flight path alignment guidance lighting system .....	853
CS HPT-DSN.F.650	Visual alignment guidance system.....	853
GM1 HPT-DSN.F.650	Visual alignment guidance system .....	856
CS HPT-DSN.F.660	Visual approach slope indicator.....	857
GM1 HPT-DSN.F.660	Visual approach slope indicator.....	859
CS HPT-DSN.F.670	Final approach and take-off area lighting systems.....	859
GM1 HPT-DSN.F.670	Final approach and take-off area lighting systems .....	860
CS HPT-DSN.F.680	Aiming point lights .....	860
GM1 HPT-DSN.F.680	Aiming point lights .....	861
CS HPT-DSN.F.690	Touchdown and lift-off area lighting system .....	861
GM1 HPT-DSN.F.690	Touchdown and lift-off area lighting system.....	862
CS HPT-DSN.F.700	Taxiway lights.....	862
GM1 HPT-DSN.F.700	Taxiway lights .....	863
CS HPT-DSN.F.710	Visual aids for denoting obstacles .....	863
GM1 HPT-DSN.F.710	Visual aids for denoting obstacles .....	863



## COVER REGULATION

### **COMMISSION REGULATION (EU) No 139/2014 of 12 February 2014 laying down requirements and administrative procedures related to aerodromes pursuant to Regulation (EC) No 216/2008 of the European Parliament and of the Council**

*Regulation (EU) No 139/2014*

THE EUROPEAN COMMISSION,

Having regard to the Treaty on the Functioning of the European Union,

Having regard to Regulation (EC) No 216/2008 of the European Parliament and of the Council of 20 February 2008 on common rules in the field of civil aviation and establishing a European Aviation Safety Agency, and repealing Council Directive 91/670/EEC, Regulation (EC) No 1592/2002 and Directive 2004/36/EC <sup>(1)</sup>, amended by Regulation (EC) No 1108/2009 of the European Parliament and of the Council of 21 October 2009 <sup>(2)</sup>, and in particular Article 8a(5) thereof,

Whereas:

- (1) Regulation (EC) No 216/2008 aims at establishing and maintaining a high uniform level of civil aviation safety in Europe.
- (2) The implementation of Regulation (EC) No 216/2008 requires the establishment of detailed Implementing Rules, in particular concerning the safety regulation of aerodromes, in order to maintain a high uniform level of civil aviation safety in the Union while pursuing the objective of an overall improvement in aerodrome safety.
- (3) It requires the Commission to adopt the necessary Implementing Rules for establishing the conditions for the design and safe operation of aerodromes referred to in Article 8a(5) before 31 December 2013.
- (4) In order to ensure a smooth transition and a high level of civil aviation safety in the Union, the Implementing Rules should reflect the state of the art and the best practices in the field of aerodromes; take into account the applicable International Civil Aviation Organization (hereinafter referred to as 'ICAO') Standards and Recommended Practices, thereby respecting ICAO's respective classification throughout the system of rules; and worldwide aerodrome operation experience, and scientific and technical progress in the field of aerodromes; be proportionate to the size, traffic, category and complexity of the aerodrome and nature and volume of operations thereon; provide for the necessary flexibility for customised compliance; and cater for the cases of aerodrome infrastructure which has been developed, prior to the entry into force of this Regulation, in accordance with the different requirements contained in the national legislations of the Member States.
- (5) It is necessary to provide sufficient time for the aerodrome industry and Member States administrations to adapt to the new regulatory framework and to verify the continued validity of certificates issued before the entry into force of this Regulation.
- (6) With a view to ensuring uniformity in the application of common requirements, it is essential that common standards be applied by the Competent Authorities and, where applicable, the Agency when assessing compliance with these requirements; the Agency should develop Acceptable Means of Compliance and Guidance Material to facilitate the necessary regulatory uniformity. The common requirements should cater for identical processes within the

<sup>1</sup> OJ L 79, 13.3.2008, p. 1.

<sup>2</sup> OJ L 309, 24.11.2009, p. 51.

competent authorities across the different aviation domains. They should not prevent, however, the application of slightly different processes if and where necessary or beneficial, for example in the case of separate overseeing entities for aerodromes and air operations. The safety objective of these requirements should remain unaffected by the different ways of technical compliance.

- (7) With regard to obstacle management in the aerodrome surroundings as well as to other activities taking place outside the aerodrome's boundary each Member State may designate different authorities and other entities in charge of monitoring, assessment and mitigation risks. The aim of this Regulation is not to change current allocation of tasks within the Member State. However a seamless organisation of the competences regarding the safeguarding of aerodrome surroundings and the monitoring and mitigating of risk caused by human activities should be ensured in each Member State. It should therefore be ensured that authorities which are entrusted with responsibilities of safeguarding the surrounding of aerodromes have the adequate competencies to fulfil their obligations.
- (8) Specific services referred to in subpart B of Annex IV (Part ADR.OPS) should be provided at an aerodrome. In some cases these services are not directly provided by the aerodrome operator, but by another organisation or State entity, or combination of both. In such cases the aerodrome operator, being responsible for the operation of the aerodrome, should have arrangements and interfaces with these organisations or entities in place to ensure the provision of services according to the requirements stated in Annex IV. When such arrangements and interfaces are in place the aerodrome operator should be considered as having discharged their responsibility and should not be understood to be directly responsible or liable for any non-compliances by another entity involved in the arrangement, provided that it has complied with all applicable requirements and obligations laid down in this Regulation relevant to its responsibility under the arrangement.
- (9) Regulation (EC) No 216/2008 only concerns aerodrome certificates to be issued by Competent Authorities in so far as safety aspects are concerned. Therefore, non-safety related aspects of existing national aerodrome certificates remain unaffected.
- (10) The measures provided for in this Regulation are based on the Opinion issued by the European Aviation Safety Agency in accordance with Articles 17(2)(b) and 19(1) of Regulation (EC) No 216/2008.
- (11) The measures provided for in this Regulation are in accordance with the opinion of the Committee established by Article 65 of Regulation (EC) No 216/2008,

HAS ADOPTED THIS REGULATION:

### **Article 1 Subject matter and scope**

*Regulation (EU) No 139/2014*

1. This Regulation lays down detailed rules on:
  - (a) the conditions for establishing and notifying to the applicant the certification basis applicable to an aerodrome as set out in [Annex II](#) and [Annex III](#);
  - (b) the conditions for issuing, maintaining, amending, limiting, suspending or revoking certificates for aerodromes, certificates for organisations responsible for the operation of aerodromes, including operating limitations related to the specific design of the aerodrome as set out in [Annex II](#) and [Annex III](#);

- (c) the conditions for operating an aerodrome in compliance with the essential requirements set out in Annex Va and, if applicable, Annex Vb to Regulation (EC) No 216/2008 as set out in [Annex IV](#);
- (d) the responsibilities of the holders of certificates as set out in [Annex III](#);
- (e) the conditions for the acceptance and for the conversion of existing aerodrome certificates issued by Member States;
- (f) the conditions for the decision not to permit exemptions referred to in Article 4(3b) of Regulation (EC) No 216/2008, including criteria for cargo aerodromes, the notification of exempted aerodromes and for the review of granted exemptions;
- (g) the conditions under which operations shall be prohibited, limited or subject to certain conditions in the interest of safety as set out in [Annex III](#);
- (h) certain conditions and procedures for the declaration by and for the oversight of apron management service providers referred to in paragraph 2(e) of Article 8a of Regulation (EC) No 216/2008 as set out in [Annex II](#) and [Annex III](#).

*[applicable until 19 March 2022]*

- (h) conditions and procedures for the declaration by and for the oversight of organisations responsible for the provision of apron management services referred to in Article 37(2) of [Regulation \(EU\) 2018/1139](#) of the European Parliament and of the Council<sup>1</sup> as set out in [Annexes II](#) and [III](#).

*[applicable from 20 March 2022 — Delegated Regulation (EU) 2020/1234]*

2. Competent Authorities involved in the certification and oversight of aerodromes, aerodrome operators and apron management service providers shall comply with the requirements laid down in [Annex II](#).

3. Aerodrome operators and providers of apron management services shall comply with the requirements laid down in [Annex III](#).

*[applicable until 19 March 2022]*

3. Aerodrome operators and organisations responsible for providing apron management service shall comply with the requirements laid down in [Annexes III](#) and [IV](#).

*[applicable from 20 March 2022 — Delegated Regulation (EU) 2020/1234]*

4. Aerodrome operators shall comply with the requirements laid down in [Annex IV](#).

*[point (4) applicable until 19 March 2022]*

## **Article 2 Definitions**

*Regulation (EU) No 139/2014*

For the purpose of this Regulation, the following definitions shall apply:

---

<sup>1</sup> Regulation (EU) 2018/1139 of the European Parliament and of the Council of 4 July 2018 on common rules in the field of civil aviation and establishing a European Union Aviation Safety Agency, and amending Regulations (EC) No 2111/2005, (EC) No 1008/2008, (EU) No 996/2010, (EU) No 376/2014 and Directives 2014/30/EU and 2014/53/EU of the European Parliament and of the Council, and repealing Regulations (EC) No 552/2004 and (EC) No 216/2008 of the European Parliament and of the Council and Council Regulation (EEC) No 3922/91 (OJ L 212, 22.8.2018, p. 1).

- (1) 'aerodrome' means a defined area (including any buildings, installations and equipment) on land or water or on a fixed, fixed offshore or floating structure intended to be used either wholly or in part for the arrival, departure and surface movement of aircraft;
- (2) 'aeroplane' means a power-driven heavier-than-air aircraft, deriving its lift in flight chiefly from aerodynamic reactions on surfaces which remain fixed under given conditions of flight;
- (3) 'aircraft' means a machine that can derive support in the atmosphere from the reactions of the air other than the reactions of the air against the earth's surface;
- (4) 'apron' means a defined area intended to accommodate aircraft for purposes of loading or unloading passengers, mail or cargo, fuelling, parking or maintenance;
- (5) 'apron management service' means a service provided to manage the activities and the movement of aircraft and vehicles on an apron;
- (6) 'audit' means a systematic, independent and documented process for obtaining evidence and evaluating it objectively to determine the extent to which requirements are complied with;
- (7) 'certification specifications' mean technical standards adopted by the Agency indicating means to show compliance with Regulation (EC) No 216/2008 and its Implementing Rules and which can be used by an organisation for the purpose of certification;
- (8) 'Competent Authority' means an authority designated within each Member State with the necessary powers and responsibilities for the certification and oversight of aerodromes, as well as personnel and organisations involved therein;
- (9) 'continuing oversight' means the tasks which are conducted for the implementation of the oversight programme at any time by the Competent Authority to verify that the conditions under which a certificate has been granted continue to be fulfilled during its period of validity;
- (10) 'Deviation Acceptance and Action Document' (DAAD) means a document established by the Competent Authority to compile evidence provided to justify the acceptance of deviations from the certification specifications issued by the Agency;
- (11) 'inspection' means an independent evaluation by observation and judgement accompanied as appropriate by measurement, testing or gauging, in order to verify compliance with applicable requirements;
- (12) 'movement' means either a take-off or landing;
- (13) 'obstacle' means all fixed (whether temporary or permanent) and mobile objects, or parts thereof, that:
  - are located on an area intended for the surface movement of aircraft; or
  - extend above a defined surface intended to protect aircraft in flight; or
  - stand outside those defined surfaces and that have been assessed as being a hazard to air navigation;
- (14) 'obstacle limitation surface' means a surface that define the limits to which objects may project into the airspace;
- (15) 'obstacle protection surface' means a surface established for visual approach slope indicator system above which objects or extensions of existing objects shall not be permitted except when, in the opinion of the appropriate authority, the new object or extension would be shielded by an existing immovable object;

## Terminology

ED Decision 2014/012/R

‘Guidance Material’ (GM) means non-binding material developed by the Agency that helps to illustrate the meaning of a requirement or specification, and is used to support the interpretation of the Basic Regulation, its Implementing Rules, and AMC.

### Article 3 Oversight of aerodromes [until 19 March 2022]

#### Article 3 Oversight

#### [from 20 March 2022 — Delegated Regulation (EU) 2020/1234]

Regulation (EU) No 139/2014

1. Member States shall designate one or more entities as the Competent Authority(ies) within that Member State with the necessary powers and responsibilities for the certification and oversight of aerodromes, as well as personnel and organisations involved therein.

*[applicable until 19 March 2022]*

1. Member States shall designate one or more entities as the Competent Authority(ies) within that Member State with the necessary powers and responsibilities for the certification and oversight of aerodromes and aerodrome operators, receiving declarations and oversight of providers of apron management service, as well as personnel involved therein.

*[applicable from 20 March 2022 — Delegated Regulation (EU) 2020/1234]*

2. The Competent Authority shall be independent from aerodrome operators and providers of apron management services. This independence shall be achieved through separation, at functional level at least, between the Competent Authority and these aerodrome operators and providers of apron management services. Member States shall ensure that Competent Authorities exercise their powers impartially and transparently.
3. If a Member State designates more than one entity as Competent Authority the following conditions shall be fulfilled:
  - (a) each Competent Authority shall be responsible for specifically defined tasks and a determined geographic area; and
  - (b) coordination shall be established between these Authorities in order to ensure effective oversight of all aerodromes and aerodrome operators, as well as providers of apron management services.
4. Member States shall ensure that Competent Authority(ies) has(ve) the necessary capabilities and resources to fulfil their requirements under this Regulation.
5. Member States shall ensure that Competent Authorities’ personnel do not perform oversight activities when there is evidence that this could result directly or indirectly in a conflict of interest, in particular when relating to family or financial interest.
6. Personnel authorised by the Competent Authority to carry out certification and/or oversight tasks shall be empowered to perform at least the following tasks:
  - (a) examine the records, data, procedures and any other material relevant to the execution of the certification and/or oversight task;

- (b) take away copies of or extracts from such records, data, procedures and other material;
  - (c) ask for an oral explanation on-site;
  - (d) enter aerodromes, relevant premises, operating sites or other relevant areas and means of transport;
  - (e) perform audits, investigations, tests, exercises, assessments, inspections;
  - (f) take or initiate enforcement measures as appropriate.
7. The tasks in paragraph 6 shall be carried out in compliance with the national legislation of the Member States.

## GM1 to Article 3.2 Oversight of aerodromes

*ED Decision 2014/012/R*

### FUNCTIONAL SEPARATION

Functional separation means that a Competent Authority may be engaged in operational activities and the oversight of organisations in the same domain provided that the different functions are clearly separated and that the organisational governance ensures effective oversight by avoiding conflicts of interest by personnel and prevent their engagement in operational activities of the entities that they are meant to oversee. This could be achieved by applying appropriate management and control mechanisms.

### Article 4 Information to the European Aviation Safety Agency

*Regulation (EU) No 139/2014*

Within three months after the entry into force of this Regulation the Member States shall inform the European Aviation Safety Agency ('the Agency') of the names, locations, ICAO airport codes of the aerodromes and the names of aerodrome operators, as well as the number of passengers and cargo movements of the aerodromes to which the provisions of Regulation (EC) No 216/2008 and this Regulation apply.

### Article 5 Exemptions

*Regulation (EU) No 139/2014*

1. The Member State shall notify the Agency about their decision to grant an exemption in accordance with Article 4(3b) of Regulation (EC) No 216/2008, within one month following the decision being taken. The information transmitted to the Agency shall include the list of aerodromes concerned, the name of the aerodrome operator and the number of passengers and cargo movements of the aerodrome of the relevant year.
2. The Member State shall on an annual basis examine the traffic figures of an exempted aerodrome. If the traffic figures at such an aerodrome have exceeded those provided for in Article 4(3b) of Regulation (EC) No 216/2008 over the last three consecutive years they shall inform the Agency and revoke the exemption.
3. The Commission may at any time decide not to permit an exemption in the following cases:
  - (a) the general safety objectives of Regulation (EC) 216/2008 are not met;
  - (b) the relevant passenger and cargo traffic figures have been exceeded over the last three consecutive years;
  - (c) where the exemption does not comply with any other relevant EU legislation.

4. Where the Commission decided that exemption is not allowed, the Member State concerned shall revoke the exemption.

### **Article 6 Conversion of certificates**

*Regulation (EU) No 139/2014*

1. Certificates issued by the Competent Authority prior to 31 December 2014 on the basis of national legislations shall remain valid until they are issued in accordance with this Article, or if no such certificates are issued, 31 December 2017.
2. Before the end of the period specified in paragraph 1, the Competent Authority shall issue certificates for the aerodromes and aerodrome operators concerned, if the following conditions are met:
  - (a) the certification basis referred to in [Annex II](#) has been established using the certification specifications issued by the Agency, including any cases of equivalent level of safety and special conditions which have been identified and documented;
  - (b) the certificate holder has demonstrated compliance with the certification specifications which are different from the national requirements on which the existing certificate was issued;
  - (c) the certificate holder has demonstrated compliance with those requirements of Regulation (EC) No 216/2008 and its Implementing Rules which are applicable to its organisation and its operation and which are different from the national requirements on which the existing certificate was issued.
3. By way of derogation from paragraph 2 point (b), the Competent Authority may decide to waive demonstration of compliance if it considers that this demonstration creates an excessive or disproportionate effort.
4. The Competent Authority shall keep records, for a minimum period of five years, of the documents related to the conversion of certificates procedure.

### **Article 7 Deviations from certification specifications**

*Regulation (EU) No 139/2014*

1. The Competent Authority may, until 31 December 2024, accept applications for a certificate including deviations from the certification specifications issued by the Agency, if the following conditions are met:
  - (a) the deviations do not qualify as an equivalent level of safety case under [ADR.AR.C.020](#), nor qualify as a case of special condition under [ADR.AR.C.025](#) of [Annex II](#) to this Regulation;
  - (b) the deviations existed prior to the entry into force of this Regulation;
  - (c) the essential requirements of Annex Va to Regulation (EC) No 216/2008 are respected by the deviations, supplemented by mitigating measures and corrective actions as appropriate;
  - (d) a supporting safety assessment for each deviation has been completed.
2. The Competent Authority shall compile the evidence supporting the fulfilment of the conditions referred to in paragraph 1 in a Deviation Acceptance and Action Document (DAAD). The DAAD shall be attached to the certificate. The Competent Authority shall specify the period of validity of the DAAD.

3. The aerodrome operator and the Competent Authority shall verify that the conditions referred to in paragraph 1 continue to be fulfilled. If such is not the case the DAAD shall be amended, suspended or withdrawn.

### **Article 8 Safeguarding of aerodrome surroundings**

*Regulation (EU) No 139/2014*

1. Member States shall ensure that consultations are conducted with regard to safety impacts of constructions proposed to be built within the limits of the obstacle limitation and protection surfaces as well as other surfaces associated with the aerodrome.
2. Member States shall ensure that consultations are conducted with regard to safety impacts of constructions proposed to be built beyond the limits of the obstacle limitation and protection surfaces as well as other surfaces associated with the aerodrome and which exceed the height established by Member States.
3. Member States shall ensure coordination of the safeguarding of aerodromes located near national borders with other Member States.

## **GM1 to Article 8 Safeguarding of aerodrome surroundings**

*ED Decision 2014/012/R*

### **OTHER SURFACES**

Other surfaces associated with the aerodrome are surfaces that need to be established when operating in accordance with ICAO PANS-OPS Doc 8168 (Procedures for Air Navigation Services - Aircraft Operations), Volume II, as adopted into the national law. The term 'surfaces' in this meaning is not used uniformly in different sources of information where also terms 'area' or 'zone' may be used.

### **Article 9 Monitoring of aerodrome surroundings**

*Regulation (EU) No 139/2014*

Member States shall ensure that consultations are conducted with regard to human activities and land use such as:

- (a) any development or change in land use in the aerodrome area;
- (b) any development which may create obstacle-induced turbulence that could be hazardous to aircraft operations;
- (c) the use of hazardous, confusing and misleading lights;
- (d) the use of highly reflective surfaces which may cause dazzling;
- (e) the creation of areas that might encourage wildlife activity harmful to aircraft operations;
- (f) sources of non-visible radiation or the presence of moving or fixed objects which may interfere with, or adversely affect, the performance of aeronautical communications, navigation and surveillance systems.

### **Article 10 Wildlife hazard management**

*Regulation (EU) No 139/2014*

1. Member States shall ensure that wildlife strike hazards are assessed through:



- (a) the establishment of a national procedure for recording and reporting wildlife strikes to aircraft;
  - (b) the collection of information from aircraft operators, aerodrome personnel and other sources on the presence of wildlife constituting a potential hazard to aircraft operations; and
  - (c) an ongoing evaluation of the wildlife hazard by competent personnel.
2. Member States shall ensure that wildlife strike reports are collected and forwarded to ICAO for inclusion in the ICAO Bird Strike Information System (IBIS) database.

### **Article 11 Entry into force and application**

*Regulation (EU) No 139/2014*

1. This Regulation shall enter into force on the twentieth day following that of its publication in the *Official Journal of the European Union*.
2. Competent Authorities involved in the certification and oversight of aerodromes, aerodrome operators and apron management service providers shall comply with the requirements laid down in [Annex II](#) to this Regulation before 31 December 2017.
3. [Annexes III](#) and [IV](#) shall apply to aerodromes certified in accordance with [Article 6](#) from the date of issuance of the certificate.
4. Aerodromes whose certification procedure was initiated before 31 December 2014, but have not been issued with a certificate by this date, shall only be issued a certificate when they comply with this Regulation.
5. Point [ADR.AR.C.050](#) and point [ADR.OR.B.060](#) of [Annex II](#) and [III](#) to this Regulation, shall apply from the date on which the Implementing Rules regarding the provision of apron management services enter into force. Point [ADR.AR.A.015](#) of [Annex II](#) and point [ADR.OR.A.015](#) of [Annex III](#) shall apply to providers of apron management services from the date on which the Implementing Rules regarding the provision of apron management services enter into force.

*[point (5) applicable until 19 March 2022]*

This Regulation shall be binding in its entirety and directly applicable in all Member States.

Done at Brussels, 12 February 2014.

*For the Commission*

*The President*

José Manuel BARROSO

---

## **ANNEX I — DEFINITIONS FOR TERMS USED IN ANNEXES II TO IV**

*Delegated Regulation (EU) 2020/2148*

For the purpose of this Regulation the following definitions shall apply:

- (1) 'Acceptable Means of Compliance (AMC)' means non-binding standards adopted by the Agency to illustrate means to establish compliance with Regulation (EC) No 216/2008 and its Implementing Rules;
- (2) 'accelerate-stop distance available (ASDA)' means the length of the take-off run available plus the length of the stopway, if provided;
- (3) 'aerodrome control service' means an air traffic control (ATC) service for aerodrome traffic;
- (4) 'aerodrome equipment' means any equipment, apparatus, appurtenance, software or accessory, that is used or intended to be used to contribute to the operation of aircraft at an aerodrome;
- (5) 'aeronautical data' means a representation of aeronautical facts, concepts or instructions in a formalised manner suitable for communication, interpretation or processing;
- (6) 'aeronautical information service' means a service established within the defined area of coverage responsible for the provision of aeronautical information and data necessary for the safety, regularity, and efficiency of air navigation;
- (6a) 'Aeronautical Information Circular (AIC)' means a notice containing information that does not qualify for the origination of a notice to air men (NOTAM) or for inclusion in the AIP, but which relates to flight safety, air navigation, technical, administrative or legislative matters;
- (6b) 'aeronautical information product' means aeronautical data and aeronautical information provided either as digital data sets or as a standardised presentation in paper or electronic media. Aeronautical information products include the following:
  - AIP, including amendments and supplements,
  - AIC,
  - aeronautical charts,
  - NOTAM,
  - digital data sets;
- (6c) 'Aeronautical Information Publication (AIP)' means a publication issued by or with the authority of a Member State and containing aeronautical information of a lasting character essential to air navigation;
- (7) 'air navigation services' means air traffic services; communication, navigation and surveillance services; meteorological services for air navigation; and aeronautical information services;
- (8) 'air traffic services' means the various flight information services, alerting services, air traffic advisory services and air traffic control services (area, approach and aerodrome control services);
- (9) 'air traffic control (ATC) service' means a service provided for the purpose of:
  1. preventing collisions:
    - between aircraft, and

- in the manoeuvring area between aircraft and obstructions; and
  - 2. expediting and maintaining an orderly flow of air traffic;
- (10) ‘aircraft stand’ means a designated area on an apron intended to be used for parking an aircraft;
- (11) ‘aircraft stand taxilane’ means a portion of an apron designated as a taxiway and intended to provide access to aircraft stands only;
- (12) ‘alternative means of compliance’ are those that propose an alternative to an existing Acceptable Means of Compliance or those that propose new means to establish compliance with Regulation (EC) No 216/2008 and its Implementing Rules for which no associated Acceptable Means of Compliance have been adopted by the Agency;
- (13) ‘alerting service’ means a service provided to notify relevant organisations regarding aircraft in need of search and rescue aid, and to assist such organisations as required;
- (14) ‘apron taxiway’ means a portion of a taxiway system located on an apron and intended to provide a through taxi-route across the apron;
- (15) ‘clearway’ means a defined rectangular area on the ground or water under the control of the appropriate entity, selected or prepared as a suitable area over which an aeroplane may make a portion of its initial climb to a specified height;
- (15a) ‘contaminated runway’ means a runway whose surface area (whether in isolated areas or not) within the length and width being used is covered in significant part by one or more of the substances listed under the runway surface condition descriptors;
- (16) ‘dangerous goods’ means articles or substances which are capable of posing a risk to health, safety, property or the environment and which are shown in the list of dangerous goods in the Technical Instructions or which are classified according to those Technical Instructions;
- (17) ‘data quality’ means a degree or level of confidence that the data provided meet the requirements of the data user in terms of accuracy, resolution and integrity;
- (17a) ‘data set’ means an identifiable collection of data;
- (18) ‘declared distances’ means:
- ‘take-off run available (TORA)’,
  - ‘take-off distance available (TODA)’,
  - ‘accelerate-stop distance available (ASDA)’,
  - ‘landing distance available (LDA)’;
- (18a) ‘dry’, in respect of runway conditions, means that the surface of the runway is free of visible moisture and not contaminated within the area intended to be used;
- (19) ‘flight information service’ means a service provided for the purpose of giving advice and information useful for the safe and efficient conduct of flights;
- (19a) ‘foreign object debris (FOD)’ means an inanimate object within the movement area which has no operational or aeronautical function and which has the potential to be a hazard to aircraft operation;
- (20) ‘human factors principles’ means principles which apply to aeronautical design, certification, training, operations and maintenance and which seek safe interface between the human and other system components by proper consideration to human performance;

- 
- (21) ‘human performance’ means human capabilities and limitations which have an impact on the safety and efficiency of aeronautical operations;
- (22) ‘instrument runway’ means one of the following types of runways intended for the operation of aircraft using instrument approach procedures:
1. ‘non-precision approach runway’: a runway served by visual aids and at least one non-visual aid, intended for landing operations following a type A instrument approach operation;
  2. ‘precision approach runway, category I’: a runway served by visual aids and at least one non-visual aid, intended for landing operations following a type B CAT I instrument approach operation;
  3. ‘precision approach runway, category II’: a runway served by visual aids and at least one non-visual aid, intended for landing operations following a type B CAT II instrument approach operation;
  4. ‘precision approach runway, category III’: a runway served by visual aids and at least one non-visual aid, intended for landing operations following a type B CAT IIIA, IIIB or IIIC instrument approach operation to and along the surface of the runway;
- (23) ‘integrity’ means a degree of assurance that an aeronautical data and its value has not been lost nor altered since the data origination or authorized amendment.
- (24) ‘landing distance available (LDA)’ means the length of runway which is declared available and suitable for the ground run of an aeroplane landing;
- (24a) ‘lighting system reliability’ means the probability that the complete installation operates within the specified tolerances and the system is operationally usable;
- (24b) ‘Location Indicators’ means the latest effective edition of the ‘Location Indicators’ (Doc 7910), approved and published by the International Civil Aviation Organization;
- (25) ‘low visibility procedures’ means procedures applied at an aerodrome for the purpose of ensuring safe operations during lower than Standard Category I, other than Standard Category II, Category II and III approaches and low visibility take-offs;
- (26) ‘low visibility take-off (LVTO)’ means a take-off with a runway visual range (RVR) lower than 400 m but not less than 75 m;
- (27) ‘lower than Standard Category I operation’ means a Category I instrument approach and landing operation using Category I decision height (DH), with a runway visual range (RVR) lower than would normally be associated with the applicable decision height (DH) but not lower than 400 m;
- (28) ‘manoeuvring area’ means that part of an aerodrome to be used for the take-off, landing and taxiing of aircraft, excluding aprons;
- (29) ‘meteorological services’ means those facilities and services that provide aircraft with meteorological forecasts, briefs and observations as well as any other meteorological information and data provided by States for aeronautical use;
- (30) ‘marker’ means an object displayed above ground level in order to indicate an obstacle or delineate a boundary;
- (31) ‘marking’ means a symbol or group of symbols displayed on the surface of the movement area in order to convey aeronautical information;

- 
- (32) ‘movement area’ means that part of an aerodrome to be used for the take-off, landing and taxiing of aircraft consisting of the manoeuvring area and the apron(s);
- (33) ‘navigation services’ means those facilities and services that provide aircraft with positioning and timing information;
- (34) ‘non-instrument runway’ means a runway intended for the operation of aircraft using visual approach procedures;
- (34a) ‘notice to airmen (NOTAM)’ means a notice distributed by means of telecommunication containing information concerning the establishment, condition or change in any aeronautical facility, service, procedure or hazard, the timely knowledge of which is essential to personnel concerned with flight operations;
- (34b) ‘NOTAM code’ means the code contained in the latest effective edition of the ‘Procedures for Air Navigation Services – ICAO Abbreviations and Codes’ (PANS ABC – Doc 8400), approved and published by the International Civil Aviation Organization;’
- (35) ‘other than Standard Category II operation’ means a precision instrument approach and landing operation using ILS or MLS where some or all of the elements of the precision approach Category II light system are not available, and with:
- decision height (DH) below 200 ft but not lower than 100 ft; and
  - runway visual range (RVR) of not less than 350 m;
- (36) ‘oversight planning cycle’ means a time period in which continued compliance is verified;
- (37) ‘rapid exit taxiway’ means a taxiway connected to a runway at an acute angle and designed to allow landing aeroplanes to turn off at higher speeds than are achieved on other exit taxiways thereby minimising runway occupancy times;
- (38) ‘runway’ means a defined rectangular area on a land aerodrome prepared for the landing and take-off of aircraft;
- (38a) ‘runway condition assessment matrix (RCAM)’ means a matrix that allows the assessment of the runway condition code (RWYCC), using associated procedures, from a set of observed runway surface conditions and pilot report of braking action;
- (38b) ‘runway condition code (RWYCC)’ means a number, to be used in the runway condition report (RCR), that describes the effect of the runway surface condition on aeroplane deceleration performance and lateral control;
- (38c) ‘runway condition report (RCR)’ means a comprehensive standardised report relating to the conditions of the runway surface and their effects on the aeroplane landing and take-off performance, described by means of runway conditions code;
- (38d) ‘runway-end safety area (RESA)’ means an area symmetrical about the runway centre line and adjacent to the end of the strip primarily intended to reduce the risk of damage to an aeroplane undershooting or overrunning the runway;
- (38e) ‘runway-holding position’ means a designated position intended to protect a runway, an obstacle limitation surface, or an Instrument Landing Systems (ILS) or Microwave Landing System (MLS) critical or sensitive area at which taxiing aircraft and vehicles must stop and hold, unless otherwise authorised by the aerodrome control tower;
- (38f) ‘runway strip’ means a defined area including the runway and stopway, if provided, intended to:

- 
- (a) reduce the risk of damage to aircraft running off a runway;
  - (b) protect aircraft flying over it during take-off or landing operations;
- (38g) ‘runway surface condition’ means a description of the condition of the runway surface used in the RCR which establishes the basis for the determination of the RWYCC for aeroplane performance purposes;
- (38h) ‘runway surface condition descriptors’ means one of the following substances on the surface of the runway:
- (a) compacted snow: snow that has been compacted into a solid mass such that aeroplane tyres, at operating pressures and loadings, will run on the surface without significant further compaction or rutting of the surface;
  - (b) dry snow: snow from which a snowball cannot readily be made;
  - (c) frost: ice crystals formed from airborne moisture on a surface whose temperature is at or below freezing; frost differs from ice in that frost crystals grow independently and therefore, have a more granular texture;
  - (d) ice: water that has frozen or compacted snow that has transitioned into ice in cold and dry conditions;
  - (e) slush: snow that is so water-saturated that water will drain from it when a handful is picked up or will splatter if stepped on forcefully;
  - (f) standing water: water of depth greater than 3 mm;
  - (g) wet ice: ice with water on top of it or ice that is melting;
  - (h) wet snow: snow that contains enough water to be able to make a well compacted, solid snowball, but water will not squeeze out;
- (39) ‘runway type’ means instrument runway or non-instrument runway;
- (40) ‘runway visual range (RVR)’ means the range over which the pilot of an aircraft on the centre line of a runway can see the runway surface markings or the lights delineating the runway or identifying its centre line;
- (41) ‘safety management system’ means a systematic approach to managing safety including the necessary organisational structure, accountabilities, policies and procedures;
- (41a) ‘slippery wet runway’ means a wet runway whose surface friction characteristics for a significant portion of it have been determined to be degraded;
- (41b) ‘SNOWTAM’ means:
- (a) with effect from 7 January 2021 until 12 August 2021, a special series NOTAM notifying the presence or removal of hazardous conditions due to snow, ice, slush or standing water associated with snow, slush and ice on the movement area, by means of a specific format;
  - (b) with effect from 12 August 2021, a special series NOTAM given in a standard format, which provides a surface condition report notifying the presence or cessation of conditions due to snow, ice, slush, frost or water associated with snow, slush, ice, or frost on the movement area;

- 
- (41c) ‘specially prepared winter runway’ means a runway with a dry frozen surface of compacted snow or ice, or both, which has been treated with sand or grit or has been mechanically treated to improve runway friction;
- (42) ‘stopway’ means a defined rectangular area on the ground at the end of take-off run available prepared as a suitable area in which an aircraft can be stopped in the case of an abandoned take-off;
- (43) ‘take-off distance available (TODA)’ means the length of the take-off run available plus the length of the clearway, if provided;
- (44) ‘take-off run available (TORA)’ means the length of runway declared available and suitable for the ground run of an aeroplane taking off;
- (45) ‘taxiway’ means a defined path on a land aerodrome established for the taxiing of aircraft and intended to provide a link between one part of the aerodrome and another, including:
- aircraft stand taxilane,
  - apron taxiway,
  - rapid exit taxiway;
- (46) ‘Technical Instructions’ means the latest effective edition of the ‘Technical Instructions for the Safe Transport of Dangerous Goods by Air’ (Doc 9284-AN/905), including the Supplement and any Addenda, approved and published by the International Civil Aviation Organization;
- (47) ‘terms of the certificate’ means the following:
- ICAO Location Indicators,
  - conditions to operate (VFR/IFR, day/night),
  - aeroplane operations on specially prepared winter runways,
  - runway,
  - declared distances,
  - runway types and approaches provided,
  - aerodrome reference code,
  - scope of aircraft operations with higher aerodrome reference code letter,
  - provision of apron management services (yes/no),
  - rescue and firefighting level of protection;
- (47a) ‘type A instrument approach operation’ means an instrument approach operation with a minimum descent height or decision height at or above 75 m (250 ft);
- (47b) ‘type B instrument approach operation’ means an instrument approach operation with a decision height below 75 m (250 ft). Type B instrument approach operations are categorised as follows:
1. Category I (CAT I): a decision height not lower than 60 m (200 ft) and with either a visibility not less than 800 m or a runway visual range not less than 550 m;
  2. Category II (CAT II): a decision height lower than 60 m (200 ft), but not lower than 30 m (100 ft) and a runway visual range not less than 300 m;

3. Category IIIA (CAT IIIA): a decision height lower than 30 m (100 ft) or no decision height and a runway visual range not less than 175 m;
  4. Category IIIB (CAT IIIB): a decision height lower than 15 m (50 ft) or no decision height and a runway visual range less than 175 m, but not less than 50 m;
  5. Category IIIC (CAT IIIC): no decision height and no runway visual range limitation;
- (48) ‘visual aids’ means indicators and signalling devices, markings, lights, signs and markers or combinations thereof;
- (49) ‘wet runway’ means a runway whose surface is covered by any visible dampness or water up to and including 3 mm deep within the area intended to be used.

### GM1 38 (b) Runway condition code

*ED Decision 2021/003/R*

The purpose of the runway condition code (RWYCC) is to permit an operational aeroplane performance calculation by the flight crew.

*[applicable from 12 August 2021]*

### GM1 38 (g) Runway surface condition

*ED Decision 2021/003/R*

The runway surface conditions used in the runway condition report (RCR) establish a common language between the aerodrome operator, the aeroplane manufacturer and the aeroplane operator.

Aircraft de-icing chemicals and other contaminants are also reported but are not included in the list of runway surface condition descriptors because their effect on the runway surface friction characteristics and the RWYCC cannot be evaluated in a standardised manner.

*[applicable from 12 August 2021]*

### GM1 38 (h) Runway surface condition descriptors

*ED Decision 2021/003/R*

The descriptors under (a) to (h) are used solely in the context of the RCR and are not intended to supersede or replace any existing World Meteorological Organization (WMO) definitions.

*[applicable from 12 August 2021]*

### GM1 38h (c) Runway surface condition descriptors

*ED Decision 2021/003/R*

‘Freezing’ refers to the freezing point of water (0 degree Celsius). Under certain conditions, frost can cause the surface to become very slippery and it is then reported appropriately as downgraded RWYCC.

*[applicable from 12 August 2021]*

### GM1 38h (f) Runway surface condition descriptors

*ED Decision 2021/003/R*

Running water of depth greater than 3 mm is reported as ‘standing water’ by convention.



*[applicable from 12 August 2021]*

## **GM1 38h (g) Runway surface condition descriptors**

*ED Decision 2021/003/R*

Freezing precipitation can lead to runway conditions associated with wet ice from an aeroplane performance point of view. Wet ice can cause the surface to become very slippery. It is then reported appropriately as downgraded RWYCC.

*[applicable from 12 August 2021]*

## **GM1 41 (a) Slippery wet runway**

*ED Decision 2021/003/R*

A portion of runway in the order of 100 m long may be considered significant.

*[applicable from 12 August 2021]*

## **GM2 41 (a) Slippery wet runway**

*ED Decision 2021/003/R*

The surface friction characteristics of the runway are considered degraded when below the minimum standards.

*[applicable from 12 August 2021]*

## **GM1 41 (c) Specially prepared winter runway**

*ED Decision 2021/003/R*

‘Frozen sand’ is a method to improve the surface friction characteristics of an ice-covered surface by sand or grit fixed to the surface through a melting/freezing process. Frozen sand can be achieved using several techniques. One example is pre-wetting the material with hot water just prior to application in order to have the hot sand melting the top layer of the ice, which then immediately refreezes to fix the material to the surface. Another technique is to pre-wet the material with a suitable chemical in order to achieve a similar effect.

*[applicable from 12 August 2021]*

# ANNEX II — PART-ADR.AR

## PART AUTHORITY REQUIREMENTS — AERODROMES

### SUBPART A — GENERAL REQUIREMENTS (ADR.AR.A)

#### ADR.AR.A.001 Scope

Regulation (EU) No 139/2014

This Annex establishes requirements for the Competent Authorities involved in the certification and oversight of aerodromes, aerodrome operators and apron management service providers.

[applicable until 19 March 2022]

This Annex establishes requirements for the Competent Authorities responsible for:

- (a) the certification and oversight of aerodromes and aerodrome operators;
- (b) receiving declarations of capability and availability of the means to discharge the responsibilities by the organisations responsible for the provision of apron management services and their oversight.

[applicable from 20 March 2022 — Regulation (EU) No 2020/1234]

#### ADR.AR.A.005 Competent Authority

Regulation (EU) No 139/2014

The Competent Authority designated by the Member State in which an aerodrome is located shall be responsible for the:

- (a) certification and oversight of aerodromes and its aerodrome operators;
- (b) oversight of providers of apron management services.

[applicable until 19 March 2022]

- (b) receiving declarations of capability and availability of the means to discharge the responsibilities by the organisations responsible for the provision of apron management services and their oversight.

[applicable from 20 March 2022 — Delegated Regulation (EU) 2020/1234]

#### ADR.AR.A.010 Oversight documentation

Regulation (EU) No 139/2014

- (a) The Competent Authority shall provide the relevant legislative acts, standards, rules, technical publications and related documents to its relevant personnel in order to perform their tasks and to discharge their responsibilities.
- (b) The Competent Authority shall make available legislative acts, standards, rules, technical publications and related documents to aerodrome operators and other interested parties to facilitate their compliance with the applicable requirements.

[applicable until 19 March 2022]

- (b) The Competent Authority shall make available legislative acts, standards, rules, technical publications and related documents to aerodrome operators, organisations responsible for the provision of AMS and other interested parties to facilitate their compliance with the applicable requirements.

*[applicable from 20 March 2022 — Delegated Regulation (EU) 2020/1234]*

## GM1 ADR.AR.A.010(b) Oversight documentation

*ED Decision 2014/012/R*

### AVAILABILITY OF DOCUMENTATION TO THIRD PARTIES

The legislative acts, standards, rules, technical publications, and similar documents should be made available, in a timely manner, to the aerodrome operators and any other interested party in various ways and formats, such as via its website, the government's official gazette, or any other similar means.

The way for making such material available, including possible application of fees, is for the Competent Authority to decide.

Making such documentation available is without prejudice to the application of rules regarding protection of intellectual property rights, or similar applicable legislation.

*[applicable until 19 March 2022]*

Legislative acts, standards, rules, technical publications, and other similar documents are made available, in a timely manner, to aerodrome operators, organisations responsible for the provision of apron management services (AMS) and to any other party concerned in various ways and formats, such as via websites, the respective government's official gazette, or any other means.

The way to make such material available, including the possible application of fees, is for the Competent Authority to decide.

Making such documentation available is without prejudice to the application of rules regarding the protection of intellectual property rights, or similar applicable legislation.

*[applicable from 20 March 2022 — ED Decision 2020/021/R]*

## ADR.AR.A.015 Means of compliance

*Regulation (EU) No 139/2014*

- (a) The Agency shall develop Acceptable Means of Compliance (AMC) that may be used to establish compliance with Regulation (EC) No 216/2008 and its Implementing Rules. When the Acceptable Means of Compliance are complied with, the related requirements of the Implementing Rules are met.
- (b) Alternative means of compliance may be used to establish compliance with the Implementing Rules.
- (c) The Competent Authority shall establish a system to consistently evaluate that the alternative means of compliance used by itself or by aerodrome operators or providers of apron management services under its oversight provide for compliance with Regulation (EC) No 216/2008 and its Implementing Rules.
- (d) The Competent Authority shall evaluate the alternative means of compliance proposed by an aerodrome operator or a provider of apron management services, in accordance with [ADR.OR.A.015](#), by analysing the documentation provided and, if considered necessary,

conducting an inspection of the aerodrome operator, the aerodrome or the provider of apron management services.

*[applicable until 19 March 2022]*

- (d) The Competent Authority shall evaluate the alternative means of compliance proposed by an aerodrome operator or an organisation responsible for the provision of AMS, in accordance with point [ADR.OR.A.015](#), by analysing the documentation provided and, if considered necessary, conducting an inspection of the aerodrome operator, the aerodrome or the organisation responsible for the provision of AMS.

*[applicable from 20 March 2022 — Delegated Regulation (EU) 2020/1234]*

When the Competent Authority finds that the alternative means of compliance proposed by the aerodrome operator or the provider of apron management services are in accordance with the Implementing Rules, it shall without undue delay:

- (1) notify the applicant that the alternative means of compliance may be implemented and, if applicable, amend the certificate or approval of the applicant accordingly;
- (2) inform the Agency of their content, including copies of the relevant documentation;
- (3) inform other Member States about alternative means of compliance that were accepted; and
- (4) inform the other certified aerodromes located in the Member State of the Competent Authority, as appropriate.

*[applicable until 19 March 2022]*

- (4) inform the certified aerodromes and the organisation responsible for the provision of AMS under its oversight, as appropriate.

*[applicable from 20 March 2022 — Delegated Regulation (EU) 2020/1234]*

- (e) When the Competent Authority itself uses alternative means of compliance to achieve compliance with Regulation (EC) No 216/2008 and its Implementing Rules, it shall:
- (1) make them available to aerodrome operators and providers of apron management services under its oversight; and
  - (2) without undue delay notify the Agency.

The Competent Authority shall provide the Agency with a full description of the alternative means of compliance, including any revisions to procedures that may be relevant, as well as an assessment demonstrating that the Implementing Rules are met.

## AMC1 ADR.AR.A.015(d)(3) Means of compliance

*ED Decision 2014/012/R*

### GENERAL

The information to be provided to other Member States following approval of an alternative means of compliance should contain a reference to the Acceptable Means of Compliance (AMC) to which such means of compliance provides an alternative, as well as a reference to the corresponding Implementing Rule, indicating as applicable the subparagraph(s) covered by the alternative means of compliance.

## GM1 ADR.AR.A.015 Means of compliance

ED Decision 2014/012/R

### GENERAL

Alternative means of compliance used by a Competent Authority or by organisations under its oversight may be used by other Competent Authorities or organisations only if processed again in accordance with [ADR.AR.A.015 \(d\) and \(e\)](#).

## ADR.AR.A.025 Information to the Agency

Regulation (EU) No 139/2014

- (a) The Competent Authority shall without undue delay notify the Agency in case of any significant problems with the implementation of Regulation (EC) No 216/2008 and its Implementing Rules.
- (b) The Competent Authority shall provide the Agency with safety-significant information stemming from the occurrence reports it has received.

## ADR.AR.A.030 Immediate reaction to a safety problem

Regulation (EU) No 139/2014

- (a) Without prejudice to Directive 2003/42/EC of the European Parliament and the Council<sup>1</sup>, the Competent Authority shall implement a system to appropriately collect, analyse and disseminate safety information.  
*[applicable until 19 March 2022]*
- (a) The Competent Authority shall implement a system to appropriately collect, analyse and disseminate safety information in accordance with [Regulation \(EU\) No 376/2014](#) of the European Parliament and of the Council<sup>2</sup>.  
*[applicable from 20 March 2022 — Delegated Regulation (EU) 2020/1234]*
- (b) The Agency shall implement a system to appropriately analyse any relevant safety information received and without undue delay provide to Member States and the Commission any information, including recommendations or corrective actions to be taken, necessary for them to react in a timely manner to a safety problem involving aerodromes, aerodrome operators and providers of apron management services subject to Regulation (EC) No 216/2008 and its Implementing Rules.
- (c) Upon receiving the information referred to in points (a) and (b), the Competent Authority shall take adequate measures to address the safety problem, including the issuing of safety directives in accordance with [ADR.AR.A.040](#).
- (d) Measures taken in accordance with point (c) shall immediately be notified to the aerodrome operators or providers of apron management services which need to comply with them under Regulation (EC) No 216/2008 and its Implementing Rules. The Competent Authority shall also notify those measures to the Agency and, when combined action is required, the other Member States concerned.

<sup>1</sup> OJ L 167, 4.7.2003, p. 23.

<sup>2</sup> Regulation (EU) No 376/2014 of the European Parliament and of the Council of 3 April 2014 on the reporting, analysis and follow-up of occurrences in civil aviation, amending Regulation (EU) No 996/2010 of the European Parliament and of the Council and repealing Directive 2003/42/EC of the European Parliament and of the Council and Commission Regulations (EC) No 1321/2007 and (EC) No 1330/2007 ([OJ L 122, 24.4.2014, p. 18](#)).

*[applicable until 19 March 2022]*

- (d) Measures taken in accordance with point (c) shall immediately be notified to the aerodrome operators or organisations responsible for the provision of AMS which need to comply with them under [Regulation \(EU\) 2018/1139](#) and the delegated and implementing acts adopted on the basis thereof. The Competent Authority shall also notify those measures to the Agency and, when combined action is required, the other Member States concerned.

*[applicable from 20 March 2022 — Delegated Regulation (EU) 2020/1234]*

- (e) Measures notified to an organisation responsible for the provision of AMS shall also be notified to the operator of the aerodrome where the service is provided.

*[applicable from 20 March 2022 — Delegated Regulation (EU) 2020/1234]*

## AMC1 ADR.AR.A.030(d) Immediate reaction to a safety problem

*ED Decision 2014/012/R*

### NOTIFICATION OF MEASURES

When the Competent Authority directs a measure to a provider of apron management services, these measures should also be notified to the aerodrome operator.

*[AMC1 ADR.AR.A.030(d) applicable until 19 March 2022 — ED Decision 2020/021/R]*

## ADR.AR.A.040 Safety directives

*Regulation (EU) No 139/2014*

- (a) The Competent Authority shall issue a safety directive if it has determined the existence of an unsafe condition requiring immediate action, including the showing of compliance with any amended or additional certification specification established by the Agency, which the Competent Authority finds is necessary.
- (b) A safety directive shall be forwarded to the aerodrome operators or providers of apron management services concerned, as appropriate, and shall contain, as a minimum, the following information:
- (1) the identification of the unsafe condition;
  - (2) the identification of the affected design, equipment, or operation;
  - (3) the actions required and their rationale, including the amended or additional certification specifications that have to be complied with;
  - (4) the time limit for compliance with the required actions; and
  - (5) its date of entry into force.
- (c) The Competent Authority shall forward a copy of the safety directive to the Agency.
- (d) The Competent Authority shall verify the compliance of aerodrome operators and providers of apron management services with the applicable safety directives.
- (e) Safety directives notified to the organisation responsible for the provision of AMS shall also be notified to the operator of the aerodrome where the service is provided.

*[point (e) applicable from 20 March 2022 — Delegated Regulation (EU) 2020/1234]*

## GM1 ADR.AR.A.040(b) Safety directives

ED Decision 2014/012/R

### FORWARDING OF SAFETY DIRECTIVES

The safety directives that should be forwarded to the Agency under [ADR.AR.A.040](#) include, but are not limited to, cases like the following ones, where the Competent Authority has determined:

- (a) that it is necessary to include additional certification specifications in the certification basis of an aerodrome;
- (b) that aerodrome equipment has presented unusual, or frequent, or otherwise unjustified malfunctions or failures;
- (c) that the certification specifications established by the Agency are such that under given conditions additional action is required to be undertaken in order to maintain the level of safety;
- (d) that there is immediate need to take certain action in order to respond to a safety recommendation or following an accident or serious incident; or
- (e) that this or a similar unsafe condition may be present at other aerodromes of the same Member State.

Member States' Competent Authorities may issue directives (which may be called operational directives, or otherwise) during its oversight activities, such as an instruction to the aerodrome operator to abstain from a certain activity, or a positive action (e.g. cutting of trees which are found to penetrate the OLS, or the removal of certain object from the aerodrome etc.) needed to maintain the level of safety. Such directives are not meant to be forwarded to the Agency.

*[applicable until 19 March 2022]*

## GM1 ADR.AR.A.040(b) Safety directives

ED Decision 2020/021/R

### FORWARDING OF SAFETY DIRECTIVES

The safety directives that are forwarded to the Agency under [ADR.AR.A.040](#) include but are not limited to cases like the following ones, where the Competent Authority has determined that:

- (a) it is necessary to include additional certification specifications in the certification basis of an aerodrome;
- (b) the aerodrome equipment has presented unusual, or frequent, or otherwise unjustified malfunctions or failures;
- (c) the certification specifications established by the Agency are such that under given conditions additional action is required to be undertaken in order to maintain the level of safety;
- (d) there is immediate need to take certain action in order to respond to a safety recommendation or following an accident or serious incident; or
- (e) this or a similar unsafe condition may be present at other aerodromes of the same Member State.

Member States' Competent Authorities may issue directives (which may be called 'operational directives' or otherwise) during their oversight activities, such as the instruction to the aerodrome operator or to the organisation responsible for the provision of AMS to abstain from a certain activity, or a positive action (e.g. cutting of trees which are found to penetrate the OLS, or the removal of

certain objects from the aerodrome, etc.) needed to maintain the level of safety. Such directives are not to be forwarded to the Agency.

*[applicable from 20 March 2022]*



## SUBPART B — MANAGEMENT (ADR.AR.B)

### ADR.AR.B.005 Management system

Regulation (EU) No 139/2014

- (a) The Competent Authority shall establish and maintain a management system, including as a minimum:
- (1) documented policies and procedures to describe its organisation, means and methods to achieve compliance with Regulation (EC) No 216/2008 and its Implementing Rules. The procedures shall be kept up to date and serve as the basic working documents within that Competent Authority for all related tasks;
  - (2) a sufficient number of personnel, including aerodrome inspectors, to perform its tasks and discharge its responsibilities. Such personnel shall be qualified to perform their allocated tasks and have the necessary knowledge, experience, initial, on-the-job and recurrent training to ensure continuing competence. A system shall be in place to plan the availability of personnel, in order to ensure the proper completion of all related tasks;
  - (3) adequate facilities and office accommodation to perform the allocated tasks;
  - (4) a formal process to monitor compliance of the management system with the relevant requirements and adequacy of the procedures, including the establishment of an internal audit process and a safety risk management process.
- (b) The Competent Authority shall, for each field of activity included in the management system, appoint one or more persons with the overall responsibility for the management of the relevant task(s).
- (c) The Competent Authority shall establish procedures for participation in a mutual exchange of all necessary information and assistance of other competent authorities concerned.

*[applicable until 19 March 2022]*

- (c) The Competent Authority shall establish procedures for participation in a mutual exchange of all necessary information and assistance with other competent authorities concerned, including information on all findings raised, corrective follow-up actions taken in response to such findings, and enforcement measures taken as a result of oversight of the organisation responsible for the provision of AMS registered in more than one Member State.

*[applicable from 20 March 2022 — Delegated Regulation (EU) 2020/1234]*

### AMC1 ADR.AR.B.005(a) Management system

ED Decision 2014/012/R

#### GENERAL

- (a) The following should be considered when deciding upon the required organisational structure:
- (1) the number of certificates and approvals to be issued;
  - (2) the number of declared organisations;
  - (3) the number and complexity of aerodromes, aerodrome operators, and providers of apron management services within that Member State;

- (4) the possible allocation of tasks to third natural or legal persons of resources needed to fulfil the continuing oversight obligations;
  - (5) the level of civil aviation activity;
  - (6) the size of the Member State's aviation industry; and
  - (7) the potential growth of activities in the field of civil aviation.
- (b) The set-up of the organisational structure should ensure that carrying out the various tasks and obligations of the Competent Authority do not rely solely on individuals. A continuous and undisturbed fulfilment of these tasks and obligations of the Competent Authority should also be guaranteed in case of illness, accident, or leave of individual employees.

## GM1 ADR.AR.B.005(a) Management system

*ED Decision 2014/012/R*

### GENERAL

- (a) The Competent Authority designated by each Member State should be organised in such a way that:
- (1) there is specific and effective management authority in the conduct of all relevant activities;
  - (2) the functions and processes described in the applicable requirements of Regulation (EC) No 216/2008 and its Implementing Rules, and AMCs, CSs, and GM may be properly implemented;
  - (3) the Competent Authority's organisation and operating procedures for the implementation of the applicable requirements of the Regulation (EC) No 216/2008 and its Implementing Rules are properly documented and applied;
  - (4) all Competent Authority personnel involved in the related activities are provided with training where necessary;
  - (5) specific and effective provision is made for the communication and interface as necessary with the Agency and the competent authorities of other Member States; and
  - (6) all functions related to implementing the applicable requirements are adequately described.
- (b) A general policy, in respect of activities related to the applicable requirements of Regulation (EC) No 216/2008 and its Implementing Rules, including certification specifications, should be developed, promoted, and implemented by the manager at the highest appropriate level; for example the manager at the top of the functional area of the Competent Authority that is responsible for such activities.
- (c) Appropriate steps should be taken to ensure that the policy is known and understood by all personnel involved, and all necessary steps should be taken to implement and maintain the policy.
- (d) The general policy, whilst also satisfying additional national regulatory responsibilities, should in particular take into account:
- (1) the provisions of Regulation (EC) No 216/2008;
  - (2) the provisions of the applicable Implementing Rules and their Acceptable Means of compliance, certification specifications, and Guidance Material;

- (3) the needs of industry; and
  - (4) the needs of the Agency and of the Competent Authority.
- (e) The policy should define specific objectives for key elements of the organisation and processes for implementing related activities, including the corresponding control procedures and the measurement of the achieved standard.

## AMC1 ADR.AR.B.005(a)(1) Management system

*ED Decision 2014/012/R*

### DOCUMENTED POLICIES AND PROCEDURES

- (a) The various elements of the organisation involved with the activities related to the applicable requirements of Regulation (EC) No 216/2008 and its Implementing Rules should be documented in order to establish a reference source for the establishment and maintenance of this organisation.
- (b) The documented policies and procedures should be established in a way that facilitates their use. They should be clearly identified, kept up to date, and made readily available to all personnel involved in the relevant activities.
- (c) The documented policies and procedures should cover, as a minimum, the following aspects:
  - (1) policy and objectives;
  - (2) organisation structure;
  - (3) responsibilities and associated authority;
  - (4) processes and procedures;
  - (5) internal and external interfaces;
  - (6) internal control procedures;
  - (7) training of personnel;
  - (8) cross references to associated documents; and
  - (9) assistance from other competent authorities or the Agency (where required).
- (d) Except for smaller competent authorities, it is likely that the information is held in more than one document, or series of documents, and suitable cross-referencing should be provided. For example, organisational structure and job descriptions are not usually in the same documentation as the policies and the detailed working procedures. In such cases, it is recommended that the documented procedures include an index of cross references to all such other related information, and the related documentation should be readily available when required.

## AMC2 ADR.AR.B.005(a)(1) Management system

*ED Decision 2014/012/R*

### DOCUMENTED POLICIES AND PROCEDURES

- (a) The procedures in the Competent Authority's management system should provide, at least, the following information:
  - (1) regarding continuing oversight functions undertaken by the Competent Authority, the Competent Authority's organisational structure with description of the main processes.

This information should demonstrate the allocation of responsibilities within the Competent Authority, and that the Competent Authority is capable of carrying out the full range of tasks regarding the size and complexity of the Member State's aerodrome industry. It should, also, consider overall proficiency and authorisation scope of Competent Authority personnel;

- (2) changes which significantly affect the Competent Authority's oversight capabilities;
  - (3) for personnel involved in oversight activities, the minimum professional qualification requirements and experience, and principles guiding appointment (e.g. assessment);
  - (4) how the following are carried out: assessing applications and evaluating compliance, issuance of certificates, performance of continuing oversight, follow-up of findings and observations, enforcement measures, and resolution of safety concerns;
  - (5) principles of managing exemptions, derogations, cases of equivalent level of safety, and special conditions;
  - (6) systems used to disseminate applicable safety information for timely reaction to a safety problem;
  - (7) criteria for planning continuing oversight (oversight programme), including adequate management of interfaces when conducting continuing oversight (aerodrome operations and ATS operations for example); and
  - (8) outline of the initial training of newly recruited oversight personnel (taking future activities into account), and the basic framework for continuation training of oversight personnel.
- (b) The procedures in the Competent Authority's management system should include any amendments to these procedures

## **AMC1 ADR.AR.B.005(a)(2) Management system**

*ED Decision 2014/012/R*

### **TRAINING PROGRAMME AND RECURRENT TRAINING**

- (a) The Competent Authority should establish a training programme for its personnel, including its aerodrome inspectors, and a plan for its implementation.
- (b) The training programme should cover the specific needs of the personnel and the Competent Authority.
- (c) The training programme should include, as appropriate to the role, current knowledge, experience and skills of the personnel, at least the following:
  - (1) aviation legislation, organisation, and structure;
  - (2) the Chicago Convention, relevant ICAO Annexes and documents, the applicable requirements of Regulation (EC) No 216/2008, its Implementing Rules and related Acceptable Means of Compliance, certification specifications and Guidance Material, as well as assessment methodology of the alternative means of compliance, and the applicable national legislation;
  - (3) the applicable requirements and procedures;
  - (4) areas of particular interest that include, but are not limited to:

- (i) management systems, including safety management systems, safety assurance principles, and quality and security management systems as applied to aeronautical data and aeronautical information;
  - (ii) acceptability and auditing of safety managements systems;
  - (iii) change management;
  - (iv) aeronautical studies, safety assessments, and reporting techniques;
  - (v) human factors principles;
  - (vi) aerodrome design;
  - (vii) signs, markings, and lighting;
  - (viii) aerodrome maintenance;
  - (ix) aerodrome operations, including:
    - (A) aerodrome safeguarding, including obstacle assessment;
    - (B) rescue and firefighting;
    - (C) emergency planning;
    - (D) disabled aircraft removal;
    - (E) low visibility operations;
    - (F) adverse weather operations;
    - (G) wildlife management;
    - (H) apron management and apron safety management;
    - (I) handling of dangerous goods; and
    - (J) fuel, facilities, storage and handling;
  - (x) evaluation, approval, and review of aerodrome manuals;
  - (xi) other suitable technical training appropriate to the role and tasks of the personnel; and
  - (xii) enforcement measures.
- (5) The training programme and plan should be updated, as needed, to reflect, at least, changes in aviation legislation, and industry.
- (6) The Competent Authority should ensure that its personnel, including its aerodrome inspectors, undergo recurrent training at regular intervals defined by the Competent Authority or whenever deemed necessary, in order to be kept up to date.

## **AMC2 ADR.AR.B.005(a)(2) Management system**

*ED Decision 2014/012/R*

### **QUALIFICATION AND TRAINING - AERODROME INSPECTORS**

- (a) Initial training should encompass:
- (1) Initial theoretical training

The scope of the initial theoretical training is to familiarise the trainee aerodrome inspectors with the finding categorisation, reporting, follow-up procedures, and

enforcement. The primary scope of the theoretical training is not the transfer of technical knowledge as the trainees should possess such knowledge, either from previous work experience or through specialised training, prior to attending the theoretical course (for the areas to be covered in the training programme see [AMC1 ADR.AR.B.005\(a\)\(2\)](#)). Amongst others, the theoretical training should cover theory of audits and inspections, as well as quality/safety assurance.

(2) Practical training

The scope of practical training is to instruct on audit/inspection techniques and specific areas of attention without interference with the operation of the aerodrome activities.

The Competent Authority should ensure that trainees have successfully completed the initial theoretical and practical training above by passing a relevant assessment.

(3) On-the-job training

The objective of the on-the-job training is to familiarise the trainees with the particularities of performing an aerodrome audit/inspection in a real, operational environment.

(a) Duration and conduct of the on-the-job training

The duration of the on-the-job training should be customised to the particular training needs of every trainee and cover, as much as possible, the audit/inspection items which the inspector will be privileged to inspect. The on-the-job training should include at least four aerodrome audits/ inspections.

(b) The scope and elements to be covered during the on-the-job training

(i) Preparation of an audit/inspection:

- (A) sources of information for preparation of audit/inspection;
- (B) areas of concern and/or open findings;
- (C) selection of aerodrome operator(s) to be audited/inspected; and
- (D) task allocation among members of the audit/inspection team.

(ii) Administrative issues of the inspection:

- (A) aerodrome inspector's credentials, rights, and obligations;
- (B) aerodrome access procedures;
- (C) safety and security airside procedures; and
- (D) aerodrome inspector's toolkit (fluorescent vest, checklists, clinometer, distance measurement devices, digital camera, GPS, etc.).

(iii) Audit/Inspection:

- (A) introduction — opening meeting;
- (B) on-site activities (audit/inspection according to the area of expertise of the trainee);
- (C) findings (identification, categorisation, evidencing, reporting); and
- (D) corrective actions — enforcement.

(iv) Closing meeting — debriefing on the audit/inspection conclusions

- (v) Preparation, completion, and delivery of the audit/inspection report
  - (vi) Human factors elements:
    - (A) cultural aspects;
    - (B) resolution of disagreements and/or conflicts; and
    - (C) auditee stress.
  - (vii) Team leading if required
  - (viii) Post-audit/inspection procedures, such as monitoring the status of open audit findings, follow-up audits/inspections, and closing the findings after appropriate action has been taken by the aerodrome operator.
- (b) Assessment of trainee aerodrome inspectors
- The assessment of the trainee should be done by the aerodrome inspector providing the training. A trainee should be considered to have successfully completed the on-the-job training only after demonstrating to the aerodrome inspector providing the training that he/she possesses the professional competence, knowledge, judgement, and ability to perform aerodrome inspections in an operational environment, in accordance with the applicable requirements.
- (c) Aerodrome inspectors appointed to provide training and assessing trainees
- The aerodrome inspectors providing the training, and assessing trainee aerodrome inspectors, should be appointed by the Competent Authority and should meet the qualification criteria established by that Competent Authority. These criteria should require that the appointee has been a qualified aerodrome inspector (see [GM6 ADR.AR.B.005\(a\)\(2\)](#), for the last three years prior to his/her appointment. Additional factors to be considered when nominating aerodrome inspectors to provide training, and assess trainee aerodrome inspectors include: knowledge of training techniques, professionalism, maturity, judgment, integrity, safety awareness, communication skills, and personal standards of performance.

*[applicable until 19 March 2022]*

## AMC2 ADR.AR.B.005(a)(2) Management system

*ED Decision 2020/021/R*

### QUALIFICATION AND TRAINING — AERODROME INSPECTORS

- (a) Initial training should encompass:
- (1) Initial theoretical training
- The objective of the initial theoretical training is to familiarise the trainee aerodrome inspectors with the finding categorisation, reporting, follow-up procedures, and enforcement. The primary objective of the theoretical training is not the transfer of technical knowledge as the trainees should possess such knowledge, either from previous work experience or through specialised training, prior to attending the theoretical course (for the areas to be covered in the training programme, see AMC1 ADR.AR.B.005(a)(2)). Amongst others, the theoretical training should cover theory of audits and inspections, as well as quality/safety assurance.
- (2) Practical training

The objective of the practical training is to instruct on audit/inspection techniques and specific areas of attention without interference with the operation of the aerodrome activities.

The Competent Authority should ensure that trainees have successfully completed the initial theoretical and practical training above by passing a relevant assessment.

(3) On-the-job training

The objective of the on-the-job training is to familiarise trainees with the particularities of performing an aerodrome audit/inspection in a real, operational environment.

(a) Duration and conduct of the on-the-job training

The duration of the on-the-job training should be customised to the particular training needs of every trainee and cover, as much as possible, the audit/inspection items which the inspector will be authorized to inspect. The on-the-job training should include at least four aerodrome audits/ inspections.

(b) The scope and elements to be covered during the on-the-job training

(i) Preparation of an audit/inspection:

- (A) sources of information for the preparation of an audit/inspection;
- (B) areas of concern and/or open findings;
- (C) selection of aerodrome operator(s) or organisation(s) responsible for the provision of AMS to be audited/inspected; and
- (D) task allocation among the members of the audit/inspection team.

(ii) Administrative issues of the inspection:

- (A) aerodrome inspector credentials, rights, and obligations;
- (B) aerodrome access procedures;
- (C) safety and security airside procedures; and
- (D) aerodrome inspector toolkit (fluorescent vest, checklists, clinometer, distance-measurement devices, digital camera, GPS, etc.).

(iii) Audit/Inspection:

- (A) introduction — opening meeting;
- (B) on-site activities (audit/inspection according to the area of expertise of the trainee);
- (C) findings (identification, categorisation, evidencing, reporting); and
- (D) corrective actions — enforcement.

(iv) Closing meeting — debriefing on the audit/inspection conclusions.

(v) Preparation, completion, and delivery of the audit/inspection report.

(vi) Human factors elements:

- (A) cultural aspects;
- (B) resolution of disagreements and/or conflicts; and
- (C) auditee stress.



- (vii) Team leading, if required.
  - (viii) Post-audit/-inspection procedures, such as monitoring the status of open audit findings, follow-up audits/inspections, and closing the findings after appropriate action has been taken by the aerodrome operator or by the organisation responsible for the provision of AMS.
- (b) Assessment of trainee aerodrome inspectors

The assessment of the trainee aerodrome inspectors should be done by the aerodrome inspector that provides the training. A trainee aerodrome inspector should be considered to have successfully completed the on-the-job training only after demonstrating to the aerodrome inspector that provides the training that they possess the professional competence, knowledge, judgement, and ability to perform aerodrome inspections and audits in a real, operational environment, in accordance with the applicable requirements.
- (c) Aerodrome inspectors appointed to provide training and assess trainees

The aerodrome inspectors that provide the training, and that assess trainee aerodrome inspectors, should be appointed by the Competent Authority and should meet the qualification criteria established by that Competent Authority. These criteria should require that the appointee has been a qualified aerodrome inspector (see GM6 ADR.AR.B.005(a)(2)) for the last 3 years prior to their appointment. Additional factors to be considered when appointing aerodrome inspectors to provide training, and to assess trainee aerodrome inspectors, include: knowledge of training techniques, professionalism, maturity, judgment, integrity, safety awareness, communication skills, and personal performance standards.

*[applicable from 20 March 2022]*

## **AMC3 ADR.AR.B.005(a)(2) Management system**

*ED Decision 2014/012/R*

### **QUALIFICATION OF AERODROME INSPECTORS AFTER SUCCESSFUL COMPLETION OF TRAINING**

- (a) Upon the successful completion of the initial training (initial theoretical training, practical training, and on-the-job training) the Competent Authority should issue a formal qualification statement for each qualified aerodrome inspector listing their privileges. Credentials should also be issued for the aerodrome inspectors, to facilitate their work.
- (b) The background knowledge and/or working experience of the aerodrome inspectors determines their privileges (the scope of their inspection; what they are entitled to inspect). The Competent Authority should determine what the inspector is entitled to inspect taking into account the following considerations:
  - (1) background knowledge; and
  - (2) working experience.
- (c) The inspecting authority should put in place a system that will ensure that their aerodrome inspectors meet at all times the qualification criteria with regard to the eligibility, training, and recent experience.

## GM1 ADR.AR.B.005(a)(2) Management system

ED Decision 2014/012/R

### SUFFICIENT PERSONNEL

- (a) This Guidance Material for the determination of the required personnel is limited to the performance of certification and oversight tasks, excluding personnel required to perform tasks subject to any national regulatory requirements.
- (b) The elements to be considered when determining required personnel and planning their availability, may be divided into quantitative and qualitative elements:
- (1) Quantitative elements:
    - (i) the number of initial certificates to be issued;
    - (ii) the number of aerodromes and aerodrome operators certified by the Competent Authority;
    - (iii) the number of providers of apron management services having declared their activity to the Competent Authority;
    - (iv) the number of planned aerodrome audits and inspections; and
    - (v) the number of expected changes to the aerodrome infrastructure.
  - (2) Qualitative elements:
    - (i) the size, nature, and complexity of activities of aerodromes and aerodrome operators, as well as providers of apron management services:
      - (A) privileges of the aerodrome operator;
      - (B) type of approval, scope of approval;
      - (C) possible certification to industry standards;
      - (D) types of aerodromes operated;
      - (E) number of personnel; and
      - (F) organisational structure, existence of subsidiaries.
    - (ii) results of past oversight activities, including audits, inspections, and reviews, in terms of risks and regulatory compliance:
      - (A) number and level of findings; and
      - (B) implementation of corrective actions.
    - (iii) the size of the Member State's aviation industry, and the potential growth of activities in the field of civil aviation, which may be an indication of the number of new applications and changes to existing certificates to be expected.
- (c) Based on existing data from previous oversight planning cycles, and taking into account the situation within the Member State's aviation industry, the Competent Authority may estimate:
- (1) the standard working time required for processing applications for certificates;
  - (2) the standard working time required for processing declarations;
  - (3) the number of new declarations, or changed declarations;
  - (4) the number of new certificates to be issued for each planning period; and

- (5) the number of changes to existing certificates to be processed for each planning period.
- (d) In line with the Competent Authority's oversight policy, the following planning data should be determined specifically for each aerodrome and aerodrome operator, as well as for declared providers of apron management services:
- (1) standard number of audits/inspections to be performed per oversight planning cycle;
  - (2) standard duration of each audit/inspection;
  - (3) standard working time for audit/inspection preparation, on-site audit/inspection, reporting and follow-up, per aerodrome inspector; and
  - (4) minimum number and required qualification of aerodrome inspectors for each audit/inspection.
- (e) Standard working time could be expressed either in working hours per aerodrome inspector, or in working days per aerodrome inspector. All planning calculations should, then, be based on the same unit (hours or working days).
- (f) It is recommended to use a spread sheet application to process data defined under (c) and (d) above, to assist in determining the total number of working hours/days per oversight planning cycle required for certification, oversight, and enforcement activities. This application could also serve as a basis for implementing a system for planning the availability of personnel.
- (g) For each aerodrome, aerodrome operator, and provider of apron management services, the number of working hours/days per planning period for each qualified aerodrome inspector that may be allocated for certification, oversight and enforcement activities should be determined, taking into account:
- (1) purely administrative tasks not directly related to oversight and certification;
  - (2) training;
  - (3) participation in other projects;
  - (4) planned absence; and
  - (5) the need to include a reserve for unplanned tasks or unforeseeable events.
- (h) The determination of working time available for certification, oversight, and enforcement activities should also consider the possible use of qualified entities.
- (i) Based on the elements listed above, the Competent Authority should be able to:
- (1) monitor dates when audits and inspections are due, and when they have been carried out;
  - (2) implement a system to plan the availability of its personnel; and
  - (3) identify possible gaps between the number and qualification of its personnel, and the required volume of certification and oversight.

Care should be taken to keep planning data up to date, in line with changes in the underlying planning assumptions, with particular focus on risk-based oversight principles.

*[applicable until 19 March 2022]*

## GM1 ADR.AR.B.005(a){2} Management system

ED Decision 2020/021/R

### SUFFICIENT PERSONNEL

- (a) This Guidance Material for the determination of the required personnel is limited to the performance of certification and oversight tasks, excluding personnel required to perform tasks subject to any national regulatory requirements.
- (b) The elements to be considered when determining the required personnel and planning their availability may be divided into quantitative and qualitative elements:
  - (1) Quantitative elements:
    - (i) the number of initial certificates to be issued;
    - (ii) the number of aerodromes and aerodrome operators certified by the Competent Authority;
    - (iii) the number of organisations responsible for the provision of AMS;
    - (iv) the number of planned audits and inspections to aerodromes and organisations responsible for the provision of AMS; and
    - (v) the number of expected changes to the aerodrome infrastructure.
  - (2) Qualitative elements:
    - (i) the size, nature, and complexity of the activities of aerodromes and aerodrome operators, as well as of organisations responsible for the provision of AMS:
      - (A) privileges of the aerodrome operator or of the organisation responsible for the provision of AMS;
      - (B) type and scope of the approval;
      - (C) possible certification to industry standards;
      - (D) types of aerodromes operated;
      - (E) number of personnel; and
      - (F) organisational structure, existence of subsidiaries.
    - (ii) results of past oversight activities, including audits, inspections, and reviews, in terms of risks and regulatory compliance:
      - (A) number and level of findings; and
      - (B) implementation of corrective actions.
    - (iii) the size of the Member State's aviation industry, and the potential growth of the activities in the field of civil aviation, which may be an indication of the number of new applications and changes to existing certificates to be expected.
- (c) Based on existing data from previous oversight planning cycles, and taking into account the situation within the Member State's aviation industry, the Competent Authority may estimate:
  - (1) the standard working time required for processing applications for certificates;
  - (2) the standard working time required for processing declarations;
  - (3) the number of new declarations, or changes to declarations;

- (4) the number of new certificates to be issued for each planning period; and
  - (5) the number of changes to existing certificates to be processed for each planning period.
- (d) In line with the Competent Authority's oversight policy, the following planning data is determined specifically for each aerodrome and aerodrome operator, as well as for organisations responsible for the provision of AMS:
- (1) standard number of audits/inspections to be performed per oversight planning cycle;
  - (2) standard duration of each audit/inspection;
  - (3) standard working time for audit/inspection preparation, on-site audit/inspection, reporting and follow-up, per aerodrome inspector; and
  - (4) minimum number and required qualification of aerodrome inspectors for each audit/inspection.
- (e) Standard working time may be expressed either in working hours per aerodrome inspector, or in working days per aerodrome inspector. All planning calculations should, then, be based on the same unit (hours or working days).
- (f) It is recommended to use a spread sheet application to process data defined under (c) and (d) above, to assist in determining the total number of working hours/days per oversight planning cycle required for certification, oversight, and enforcement activities. This application could also serve as a basis for implementing a system for planning the availability of personnel.
- (g) For each aerodrome, aerodrome operator, and organisation responsible for the provision of AMS, the number of working hours/days per planning period for each qualified aerodrome inspector that may be allocated for certification, oversight and enforcement activities is determined, taking into account:
- (1) purely administrative tasks not directly related to oversight and certification;
  - (2) training;
  - (3) participation in other projects;
  - (4) planned absence; and
  - (5) the need to include a reserve for unplanned tasks or unforeseeable events.
- (h) The determination of the working time available for certification, oversight, and enforcement activities may also consider the possible use of qualified entities.
- (i) Based on the elements listed above, the Competent Authority will be able to:
- (1) monitor the dates when audits and inspections are due, and when they have been carried out;
  - (2) implement a system to plan the availability of its personnel; and
  - (3) identify possible gaps between the number and qualification of its personnel and the required volume of certification and oversight.

Care should be taken to keep planning data up to date, in line with changes in the underlying planning assumptions, with particular focus on risk-based oversight principles.

*[applicable from 20 March 2022]*

## GM2 ADR.AR.B.005(a)(2) Management system

ED Decision 2014/012/R

### AERODROME INSPECTORS — DUTIES

- (a) An aerodrome inspector is considered to be any person to whom the Competent Authority has formally assigned tasks related to the safety oversight of aerodromes.
- (b) Apart from the aerodrome oversight tasks, an aerodrome inspector may also undertake other tasks that the Competent Authority finds necessary.

[applicable until 19 March 2022]

## GM2 ADR.AR.B.005(a)(2) Management system

ED Decision 2020/021/R

### AERODROME INSPECTORS — DUTIES

- (a) An aerodrome inspector is considered any person to whom the Competent Authority has formally assigned tasks related to the safety oversight of aerodromes, of aerodrome operators and of organisations responsible for the provision of AMS.
- (b) Apart from the aerodrome oversight tasks, an aerodrome inspector may also undertake other tasks that the Competent Authority finds necessary.

[applicable from 20 March 2022]

## GM3 ADR.AR.B.005(a)(2) Management system

ED Decision 2014/012/R

### QUALIFICATION OF PERSONNEL

The term ‘qualified’ denotes fitness for the purpose. This may be achieved through fulfilment of the necessary conditions, such as completion of required training, or acquisition of a diploma or degree, or through the gaining of suitable experience. It also includes the ability, capacity, knowledge, or skill that matches or suits an occasion, or makes someone eligible for a duty, office, position, privilege, or status.

Certain posts may by nature be associated with the possession of certain qualifications in a specific field (e.g. rescue and firefighting, civil, mechanical, or electrical engineering, wildlife biology etc.). In such cases, the person occupying such a post is expected to possess the necessary qualifications at a level that is in accordance with the applicable national or European Union legislation.

## GM4 ADR.AR.B.005(a)(2) Management system

ED Decision 2014/012/R

### QUALIFICATION AND TRAINING — GENERAL

- (a) To ensure personnel remain competent, arrangements should be made for initial and recurrent training as required.
- (b) With regard to sequence of particular components of initial training, the Competent Authority should ensure that on-the-job training is undertaken only by trainees that have successfully completed the initial theoretical and practical training.
- (c) The basic capability of the Competent Authority’s personnel is a matter of recruitment, and normal management functions in selection of personnel for particular duties. Moreover, the

Competent Authority should provide training in the basic skills, as required for those duties. However, to avoid differences in understanding and interpretation, it is considered important that all personnel be provided with further training specifically related to the applicable requirements of Regulation (EC) No 216/2008, its Implementing Rules and related AMC, CS and GM, as well as related to the assessment of alternative means of compliance.

- (d) The Competent Authority may provide training through its own training organisation with qualified trainers or through another qualified training source (e.g. training provided by other competent authorities or the Agency).
- (e) When training is not provided through an internal training organisation, adequately experienced and qualified persons may act as trainers, provided their training skills have been assessed. If required, an individual training plan should be established covering specific training skills. Records should be kept of such training and of the assessment, as appropriate.

## **GM5 ADR.AR.B.005(a)(2) Management system**

*ED Decision 2014/012/R*

### **TRAINING PROGRAMME AND RECURRENT TRAINING**

When preparing the training programme, the Competent Authority should determine the areas for which the training may include realistic training elements.

As an example, the RFFS training could include parts of, or be the same with that of an aerodrome operator's RFFS personnel. If an aerodrome operator provides such training, care should be taken to avoid any possible conflict of interest.

## **GM6 ADR.AR.B.005(a)(2) Management system**

*ED Decision 2014/012/R*

### **RECENT EXPERIENCE REQUIREMENTS FOR AERODROME INSPECTORS**

- (a) An aerodrome inspector will remain qualified if he/she performs a minimum number of two aerodrome audits/inspections during the previous 12 months. In case the minimum number of audits/inspections are not achieved due to the number of aerodromes in a Member State, audits/inspections conducted on other aerodromes which are open to public use, but do not fall within the scope of Regulation (EC) No 216/2008, may also be taken into account.
- (b) If an aerodrome inspector loses his/her qualification as a result of not reaching the minimum number of inspections mentioned in paragraph (a), he/she may be re-qualified by the Competent Authority by performing the number of the missed audits/inspections under the supervision of a qualified aerodrome inspector. The missed audits/inspections should take place within a maximum period of three months following the end of the period within which he/she should have reached the minimum number of audits/inspections.
- (c) If an aerodrome inspector loses his/her qualification because he/she has not been engaged in performing audits/inspections for a period longer than that established in paragraph (a) but less than 24 months, he/she should be re-qualified by the Competent Authority only after successfully completing the on-the-job-training, and any recurrent training required.
- (d) If an aerodrome inspector loses his/her qualification because he/she has not been engaged in performing audits/inspections for more than 24 months, he/she should be fully re-qualified by the Competent Authority only after successfully completing initial theoretical, practical, and on-the-job training.

## GM1 ADR.AR.B.005(a)(3) Management system

ED Decision 2014/012/R

### FACILITIES AND OFFICE ACCOMODATION

Facilities and office accommodation include but are not limited to:

- (a) adequate offices;
- (b) a technical library available for the Competent Authority personnel, or another method to ensure receipt, control, and distribution of necessary technical documentation;
- (c) office equipment, including computers and communication means;
- (d) transportation means;
- (e) personnel protective equipment; and
- (f) equipment necessary for auditing/inspecting the aerodrome and its facilities, such as cameras, clinometers, distance measurement devices, GPS etc.

## AMC1 ADR.AR.B.005(a)(4) Management system

ED Decision 2014/012/R

### COMPLIANCE MONITORING PROCESS

The formal process to monitor compliance of the management system with the relevant requirements, and the adequacy of the procedures should:

- (a) include a feedback system of audit findings to ensure implementation of corrective actions as necessary; and
- (b) be the responsibility of a person, or group of persons who should be responsible to the senior management of the Competent Authority and who perform compliance monitoring activities with functional independence from the units/ departments they oversee and with direct access to the senior management of the Competent Authority and to appropriate management for safety matters.

## AMC1 ADR.AR.B.005(c) Management system

ED Decision 2014/012/R

### COORDINATION WITH OTHER AUTHORITIES OF THE MEMBER STATE

The Competent Authority should establish coordination arrangements with other authorities of the Member State. Such coordination arrangements should, in particular, include the following authorities:

- (a) security agencies, in order to ensure:
  - (1) international civil aviation security measures are integrated into the design and construction of aerodromes, and their facilities; and
  - (2) the optimisation of civil aviation security measures.
- (b) environmental protection authorities, for the management of conflicts between safety and environmental requirements;
- (c) local planning and land use authorities.



## ADR.AR.B.010 Allocation of tasks to qualified entities

Regulation (EU) No 139/2014

- (a) Tasks related to the initial certification or continuing oversight of persons or organisations subject to [Regulation \(EC\) No 216/2008](#) and its Implementing Rules shall be allocated by Member States only to qualified entities. When allocating tasks, the Competent Authority shall ensure that it has:
- (1) a system in place to initially and continuously assess that the qualified entity complies with Annex V to Regulation (EC) No 216/2008;  
this system and the results of the assessments shall be documented;
  - (2) established a documented agreement with the qualified entity, approved by both parties at the appropriate management level, which clearly defines:
    - (i) the tasks to be performed;
    - (ii) the declarations, reports and records to be provided;
    - (iii) the technical conditions to be met in performing such tasks;
    - (iv) the related liability coverage; and
    - (v) the protection given to information acquired in carrying out such tasks.
- (b) The Competent Authority shall ensure that the internal audit process and safety risk management process required by [ADR.AR.B.005\(a\)\(4\)](#) covers all certification or continuing oversight tasks performed on its behalf.

### AMC1 ADR.AR.B.010(a)(1) Allocation of tasks to qualified entities

ED Decision 2014/012/R

#### QUALIFICATIONS OF PERSONNEL

- (a) A qualified entity, to which tasks related to the initial certification or continuing oversight tasks are to be allocated, should have an adequate number of qualified technical personnel to conduct aerodrome inspections and audits, and to perform any other task needed during the certification and oversight process, as required by the Competent Authority.
- (b) The personnel of a qualified entity, to whom such tasks are allocated, should meet the qualification criteria applicable for competent authorities' aerodrome inspectors prescribed in [AMC1 ADR.AR.B.005\(a\)\(2\)](#), [AMC2 ADR.AR.B.005\(a\)\(2\)](#), and [AMC3 ADR.AR.B.005\(a\)\(2\)](#), (see also [GM6 ADR.AR.B.005\(a\)\(2\)](#)).

### GM1 ADR.AR.B.010 Allocation of tasks to qualified entities

ED Decision 2014/012/R

#### CERTIFICATION TASKS

The tasks that may be performed by qualified entities on behalf of the Competent Authority may include any tasks related to the initial certification and continuing oversight of aerodromes and aerodrome operators, as well as declared providers of apron management services, with the exclusion of the issuance of certificates or approvals.

*[applicable until 19 March 2022]*

## GM1 ADR.AR.B.010 Allocation of tasks to qualified entities

ED Decision 2020/021/R

### CERTIFICATION TASKS

The tasks that may be performed by qualified entities on behalf of the Competent Authority may include any tasks related to the initial certification and continuing oversight of aerodromes and aerodrome operators, as well as of organisations responsible for the provision of AMS, with the exclusion of the issuance of certificates or approvals.

[applicable from 20 March 2022]

## ADR.AR.B.015 Changes to the management system

Regulation (EU) No 139/2014

- (a) The Competent Authority shall have a system in place to identify changes that affect its capability to perform its tasks and discharge its responsibilities as defined in Regulation (EC) No 216/2008 and its Implementing Rules. This system shall enable it to take action, as appropriate, to ensure that the management system remains adequate and effective.
- (b) The Competent Authority shall update its management system to reflect any change to Regulation (EC) No 216/2008 and its Implementing Rules in a timely manner, so as to ensure effective implementation.
- (c) The Competent Authority shall notify the Agency of changes affecting its capability to perform its tasks and discharge its responsibilities as defined in Regulation (EC) No 216/2008 and its Implementing Rules.

## ADR.AR.B.020 Record keeping

Regulation (EU) No 139/2014

- (a) The Competent Authority shall establish a system of record keeping providing for adequate storage, accessibility and reliable traceability of:
  - (1) the management system's documented policies and procedures;
  - (2) training, qualification and authorisation of its personnel;
  - (3) the allocation of tasks to qualified entities, covering the elements required by [ADR.AR.B.010](#), as well as the details of tasks allocated;
  - (4) certification process and continuing oversight of aerodromes and aerodrome operators;
  - (5) declaration process and continuing oversight of providers of apron management services;
  - (6) the documentation regarding cases of equivalent level of safety and special conditions contained in the certification basis, as well as any Deviation Acceptance and Action Document (DAAD);
  - (7) the evaluation and notification to the Agency of alternative means of compliance proposed by aerodrome operators and providers of apron management services and the assessment of alternative means of compliance used by the Competent Authority itself;
  - (8) findings, corrective actions and date of action closure, and observations;
  - (9) enforcement measures taken;
  - (10) safety information and follow-up measures;

(11) the use of flexibility provisions in accordance with Article 14 of Regulation (EC) No 216/2008.

*[applicable until 19 March 2022]*

(11) the use of flexibility provisions in accordance with Article 71 of [Regulation \(EU\) 2018/1139](#).

*[applicable from 20 March 2022 — Delegated Regulation (EU) 2020/1234]*

- (b) The Competent Authority shall maintain a list of all certificates it issued and declarations it received.
- (c) Records related to the certification of an aerodrome and an aerodrome operator, or the declaration of a provider of apron management services shall be kept for the lifespan of the certificate or declaration, as appropriate.
- (d) Records relating to points (a)(1) to (a)(3) and points (a)(7) to (a)(11) shall be kept for a minimum period of five years, subject to applicable data protection law.

## AMC1 ADR.AR.B.020(a) Record-keeping

ED Decision 2014/012/R

### GENERAL

- (a) The record-keeping system should ensure that all records are accessible whenever needed within a reasonable time. These records should be organised in a way that ensures traceability and retrievability throughout the required retention period.
- (b) Records should be kept in paper form, or in electronic format, or a combination of both media. Records stored on microfilm or optical disc form are also acceptable. The records should remain legible and accessible throughout the required retention period. The retention period starts when the record has been created or last amended.
- (c) Computer systems should have, at least, one backup system which should be updated within 24 hours of any new entry. Computer systems should include safeguards against unauthorised alteration of data.
- (d) All computer hardware used to ensure data backup should be stored in a different location from that containing the working data, and in an environment that ensures they remain in good condition. When hardware or software changes take place, special care should be taken that all necessary data continue to be accessible, at least, through the full period specified in [ADR.AR.B.020\(c\) and \(d\)](#).

## AMC1 ADR.AR.B.020(a)(1);(a)(2);(a)(3) Record-keeping

ED Decision 2014/012/R

### COMPETENT AUTHORITY MANAGEMENT SYSTEM

Records related to the Competent Authority's management system should include, as a minimum, and as applicable:

- (a) the documented policies and procedures;
- (b) the personnel files of Competent Authority personnel, with supporting documents related to their training and qualifications;

- (c) the results of the Competent Authority's internal compliance monitoring and risk assessment, including audit findings and corrective actions; and
- (d) the contract(s) established with qualified entities performing certification or oversight tasks on behalf of the Competent Authority.

## AMC1 ADR.AR.B.020(a)(2) Record keeping

ED Decision 2014/012/R

### DURATION OF RETENTION PERIOD OF RECORDS

Records related to the training and qualification of the personnel of the Competent Authority should be kept until the end of their employment.

## AMC1 ADR.AR.B.020(a)(4);(a)(5) Record keeping

ED Decision 2014/012/R

### AERODROMES — AERODROME OPERATORS — APRON MANAGEMENT SERVICE PROVIDERS

Records related to a certified aerodrome and its aerodrome operator, or the provider of apron management services having declared its activity to the Competent Authority should include, as appropriate to the type of organisation:

- (a) the application for a certificate, approval, or declaration;
- (b) the documentation based upon which:
  - (1) the certificate or an approval has been granted with amendments; and
  - (2) the declaration has been registered;
- (c) the documentation related to notifications of changes by the applicant and their assessment;
- (d) the certificate or approval issued, including any changes;
- (e) a copy of the continuing oversight programme listing the dates when audits are due and when such audits were carried out;
- (f) continuing oversight records, including all audit and inspection records;
- (g) copies of all relevant correspondence;
- (h) details of any exemption or derogation, and enforcement actions;
- (i) any report from other competent authorities relating to the oversight of the aerodrome, the aerodrome operator, and the provider of apron management services, if applicable; and
- (j) a copy of any other document approved by the Competent Authority.

*[applicable until 19 March 2022]*

## AMC1 ADR.AR.B.020(a)(4);(a)(5) Record keeping

ED Decision 2020/021/R

### AERODROMES — AERODROME OPERATORS — ORGANISATIONS RESPONSIBLE FOR THE PROVISION OF AMS

Records related to a certified aerodrome and its aerodrome operator, or the organisation responsible for the provision of AMS should include, as appropriate to the type of organisation:

- (a) the application for a certificate, approval, or declaration;

- (b) the documentation based upon which:
  - (1) the certificate or the approval has been granted with amendments; and
  - (2) the declaration has been registered;
- (c) the documentation related to notifications of changes by the applicant and their assessment;
- (d) the certificate or approval issued, including any changes to it;
- (e) a copy of the continuing oversight programme listing the dates when audits are due and when such audits were carried out;
- (f) continuing oversight records, including all audit and inspection records;
- (g) copies of all relevant correspondence;
- (h) details of any exemption or derogation, and enforcement actions;
- (i) any report from other competent authorities relating to the oversight of the aerodrome, the aerodrome operator, and the organisation responsible for the provision of AMS, if applicable; and
- (j) a copy of any other document approved by the Competent Authority.

*[applicable from 20 March 2022]*

## AMC1 ADR.AR.B.020(c) Record keeping

*ED Decision 2014/012/R*

### **AERODROMES — AERODROME OPERATORS — PROVIDERS OF APRON MANAGEMENT SERVICES**

- (a) Records which are considered to be related to the certification of an aerodrome, and to be maintained for the lifespan of the certificate include, but are not limited to, the following:
  - (1) applications submitted;
  - (2) notifications of the certification specifications for an initial certification and any changes thereof, including:
    - (i) any provisions for which an equivalent level of safety has been accepted; and
    - (ii) any special conditions.
  - (3) documentation related to alternative means of compliance used;
  - (4) documentation related to Deviation Acceptance and Action Documents (DAAD) if relevant;
  - (5) documentation related to exemptions or derogations granted;
  - (6) aeronautical studies and safety assessments;
  - (7) designs of the aerodrome;
  - (8) declarations made by the applicant;
  - (9) current version of an aerodrome manual, and evidence of its evaluation; and
  - (10) approvals granted.
- (b) Records for aerodrome equipment, or parts of the aerodrome infrastructure which have been removed from the aerodrome need not be maintained.

- (c) For providers of apron management services, records include, but may not be limited to, the declarations, and the relevant documentation submitted by the providers.

*[applicable until 19 March 2022]*

## AMC1 ADR.AR.B.020(c) Record keeping

*ED Decision 2020/021/R*

### AERODROMES — AERODROME OPERATORS — ORGANISATIONS RESPONSIBLE FOR THE PROVISION OF AMS

- (a) Records which are considered related to the certification of an aerodrome, and are to be maintained for the lifetime of the certificate, include but are not limited to the following:
- (1) applications submitted;
  - (2) notifications of the certification specifications for initial certification and any changes to them, including:
    - (i) any provisions for which an equivalent level of safety has been accepted; and
    - (ii) any special conditions;
  - (3) documentation related to alternative means of compliance used;
  - (4) documentation related to Deviation Acceptance and Action Documents (DAAD), if relevant;
  - (5) documentation related to exemptions or derogations granted;
  - (6) aeronautical studies and safety assessments;
  - (7) aerodrome design;
  - (8) declarations made by the applicant;
  - (9) current version of an aerodrome manual, and evidence of its evaluation; and
  - (10) approvals granted.
- (b) Records for the aerodrome equipment or for parts of the aerodrome infrastructure which have been removed from the aerodrome need not be maintained.
- (c) Records which are considered related to an organisation responsible for the provision of AMS, and which are to be maintained for the lifespan of the declaration, include but are not limited to the following:
- (1) applications submitted;
  - (2) documentation related to alternative means of compliance used;
  - (3) safety assessments;
  - (4) declarations made by the applicant;
  - (5) current version of the management system manual, and evidence of its evaluation; and
  - (6) approvals granted.

*[applicable from 20 March 2022]*

## GM1 ADR.AR.B.020 Record keeping

ED Decision 2014/012/R

### GENERAL

Records are required to document results achieved, or to provide evidence of activities performed. Records become factual when recorded. Therefore, they are not subject to version control. Even when a new record is produced covering the same issue, the previous record remains valid.

## GM1 ADR.AR.B.020(a) Record keeping

ED Decision 2014/012/R

### MICROFILM AND OPTICAL STORAGE

Microfilming or optical storage of records may be carried out at any time. The records should be as legible as the original record, and remain so for the required retention period.

## GM2 ADR.AR.B.020(a) Record keeping

ED Decision 2014/012/R

### AERODROMES — AERODROME OPERATORS — DOCUMENTATION

Documentation to be kept as records in support of the certificate or approval includes the management system documentation, including any technical manuals, such as the aerodrome manual, that have been submitted with the initial application, and any amendments to these documents.

*[applicable until 19 March 2022]*

## GM2 ADR.AR.B.020(a) Record keeping

ED Decision 2020/021/R

### DOCUMENTATION FOR AERODROMES — AERODROME OPERATORS — ORGANISATIONS RESPONSIBLE FOR THE PROVISION OF AMS

The documentation to be kept as records in support of the certificate or approval includes the management system documentation, including any technical manuals, such as the aerodrome manual, or for the organisation responsible for the provision of AMS, the management system manual, that have been submitted with the initial application, and any amendments to them.

*[applicable from 20 March 2022]*

## SUBPART C — OVERSIGHT, CERTIFICATION AND ENFORCEMENT (ADR.AR.C)

### ADR.AR.C.005 Oversight

Regulation (EU) No 139/2014

- (a) The Competent Authority shall verify:
- (1) compliance with the certification basis and all requirements applicable to aerodromes and aerodrome operators prior to the issue of an approval or certificate;
  - (2) continued compliance with the certification basis and applicable requirements of aerodromes and aerodrome operators or providers of apron management service subject to declaration obligation; and  
*[applicable until 19 March 2022]*
  - (2) continued compliance with the certification basis and applicable requirements of aerodromes and aerodrome operators or organisations responsible for the provision of AMS; and  
*[applicable from 20 March 2022 — Delegated Regulation (EU) 2020/1234]*
  - (3) implementation of appropriate safety measures as defined in [ADR.AR.A.030\(c\) and \(d\)](#).
- (b) This verification shall:
- (1) be supported by documentation specifically intended to provide personnel responsible for safety oversight with guidance to perform their functions;
  - (2) provide the aerodrome operators and providers of apron management services concerned with the results of safety oversight activity;
  - (3) be based on audits and inspections, including unannounced inspections, where appropriate; and
  - (4) provide the Competent Authority with the evidence needed in case further action is required, including the measures foreseen by [ADR.AR.C.055](#).
- (c) The scope of oversight shall take into account the results of past oversight activities and the safety priorities identified.
- (d) The Competent Authority shall collect and process any information deemed useful for oversight, including unannounced inspections, as appropriate.
- (e) Within its oversight powers, the Competent Authority may decide to require prior approval for any obstacles, developments and other activities within the areas monitored by the aerodrome operator in accordance with [ADR.OPS.B.075](#), which may endanger safety and adversely affect the operation of an aerodrome.



## AMC1 ADR.AR.C.005 Oversight

ED Decision 2014/012/R

### GENERAL

- (a) The Competent Authority should assess the aerodrome operator, and monitor its continued competence to conduct safe operations in compliance with the applicable requirements and the certification basis. Similarly, the Competent Authority should monitor the continued competence of providers of apron management services. The Competent Authority should ensure that accountability for assessing and monitoring aerodrome operators, as well as providers of apron management services, is clearly defined. This accountability may be delegated or shared, in whole or in part.
- (b) It is essential that the Competent Authority has the full capability to adequately assess the continued competence of an aerodrome operator, or a provider of apron management services by ensuring that the whole range of activities is assessed by appropriately qualified personnel.

## GM1 ADR.AR.C.005 Oversight

ED Decision 2014/012/R

### GENERAL

- (a) Responsibility for the safe operation of an aerodrome lies with the aerodrome operator. Under these provisions, a positive move is made towards devolving upon the aerodrome operator a share of the responsibility for monitoring the safety of operations. The objective cannot be attained unless aerodrome operators are prepared to accept the implications of this policy, including that of committing the necessary resources to its implementation. Crucial to success of the policy is the content of [Part-ADR.OR](#) which requires the establishment of a management system by the aerodrome operator.
- (b) The Competent Authority should continue to assess the aerodrome operator's or apron management service provider's compliance with the applicable requirements, including the effectiveness of its management system. If their management system is judged to have failed in its effectiveness, then this in itself is a breach of the requirements which may, among others, call into question the validity of the certificate or declaration, if applicable.
- (c) The accountable manager is accountable to the Competent Authority as well as to those who may appoint him/her. It follows that the Competent Authority cannot accept a situation in which the accountable manager is denied sufficient funds, manpower, or influence to rectify deficiencies identified by the management system.

## ADR.AR.C.010 Oversight programme

Regulation (EU) No 139/2014

- (a) The Competent Authority shall for each aerodrome operator and provider of apron management services declaring their activity to the Competent Authority:  
*[applicable until 19 March 2022]*
- (a) The Competent Authority shall for each aerodrome operator and organisation responsible for the provision of AMS:  
*[applicable from 20 March 2022 — Delegated Regulation (EU) 2020/1234]*

- (1) establish and maintain an oversight programme covering the oversight activities required by [ADR.AR.C.005](#);
  - (2) apply an appropriate oversight planning cycle, not exceeding 48 months.
- (b) The oversight programme shall include within each oversight planning cycle, audits and inspections, including unannounced inspections, as appropriate.
- (c) The oversight programme and planning cycle shall reflect the safety performance of the aerodrome operator and risk exposure of the aerodrome.
- [applicable until 19 March 2022]*
- (c) The oversight programme and planning cycle shall reflect the safety performance of the aerodrome operator or the organisation responsible for the provision of AMS respectively, as well as the risk exposure of the aerodrome.
- [applicable from 20 March 2022 — Delegated Regulation (EU) 2020/1234]*
- (d) The oversight programme shall include records of the dates when audits and inspections are due and when audits and inspections have been carried out.

## AMC1 ADR.AR.C.010 Oversight programme

ED Decision 2021/003/R

### PROCEDURES FOR THE OVERSIGHT OF AERODROME OPERATORS AND OF ORGANISATIONS RESPONSIBLE FOR THE PROVISION OF AMS

- (a) The Competent Authority should assign a focal point for each aerodrome operator and for each organisation responsible for the provision of AMS. Where more than one aerodrome inspector is assigned to an aerodrome operator or to an organisation responsible for the provision of AMS, one of them should be appointed as focal point having the overall responsibility for the supervision of, and liaison with, the aerodrome operator's management or the management of the organisation responsible for the provision of AMS, and be responsible for reporting on the compliance with the requirements for its operations.
- (b) Inspections, audits, and oversight procedures, on a scale and frequency appropriate to the operation, should include but not be limited, as appropriate, to the items from the following list:
- (1) aerodrome infrastructure and equipment;
  - (2) visual aids and aerodrome electrical systems, including their maintenance programme;
  - (3) obstacle restriction and control;
  - (4) aerodrome data reporting, including reporting of surface contaminants and runway surface conditions, and NOTAM origination;
  - (5) aerodrome emergency planning;
  - (6) rescue and firefighting;
  - (7) removal of disabled aircraft;
  - (8) storage facilities and handling of dangerous goods and fuel, including fuel installations, fuel quality, and fuelling equipment;
  - (9) low-visibility operations;

- 
- (10) winter and adverse weather operations;
  - (11) protection of radar, navigation aids, and other aerodrome equipment;
  - (12) apron management;
  - (13) apron safety management;
  - (14) vehicle authorisation and operation on the movement area, including maintenance programmes;
  - (15) control of pedestrians;
  - (16) wildlife hazard management;
  - (17) runway excursion and incursion prevention programmes of the aerodrome operator, as part of the Competent Authority's runway safety programme, including the functioning and effectiveness of the aerodrome's local runway safety team, as well as the implementation of identified actions;
  - (18) FOD control programme of the aerodrome operator;
  - (19) inspections of the movement area;
  - (20) maintenance programme of the aerodrome systems and the movement area;
  - (21) aerodrome works;
  - (22) protection against hazardous activities in the aerodrome surroundings;
  - (23) personnel training and records, including review of training programme on runway excursion and incursion prevention, as well as the drivers' authorisations and language proficiency assessments, training programmes, and their implementation;
  - (24) aerodrome manuals and documentation;
  - (25) operator's management system, including its safety management system and its quality, and security management system for aeronautical data;
  - (26) operator's oversight of the compliance of the organisations operating, or providing services at the aerodrome (third parties).
- (c) Inspection or audits should be a 'deep cut' through the items selected, and all findings and observations should be recorded.
- (d) Aerodrome inspectors should analyse and assess the root cause(s) identified by the aerodrome operator or the organisation responsible for the provision of AMS, and be satisfied that the corrective actions taken are adequate to correct the non-compliance, and to prevent its reoccurrence.
- (e) Inspections and audits may be conducted jointly or separately. Inspections and audits may also be coordinated with inspections and audits conducted by the competent authorities responsible for other areas, to address areas of coordination between aerodrome operator and the providers of other services (e.g. ATM/ANS). Joint audits with competent authorities for other areas should also be performed because they are particularly effective to examine the interfaces between different actors at the aerodrome (e.g. airport and ATS), including the prevention of runway excursions and incursions.

- (f) Inspections may, at the discretion of the Competent Authority, be conducted with or without prior notice to the aerodrome operator or the organisation responsible for the provision of AMS.
- (g) Where it is apparent to an aerodrome inspector that an aerodrome operator or an organisation responsible for the provision of AMS has failed to comply with the applicable requirements, with the result that safety has been or might have been compromised, the aerodrome inspector should ensure that the person in charge within the Competent Authority is informed without delay.
- (h) In the first few months of a new operation, physical change of the aerodrome or organisational restructure, aerodrome inspectors should be particularly alert to any irregular procedures, evidence of inadequate facilities or equipment, or indications that management control of the operation may be ineffective.
- (i) Aerodrome inspectors should take account of any conditions that may indicate a significant deterioration in the financial situation of the aerodrome operator or of the organisation responsible for the provision of AMS. When any financial difficulties are identified, aerodrome inspectors should increase the technical surveillance of the operation with particular emphasis on the upholding of safety standards.
- (j) The number or the magnitude of the non-compliances identified by the Competent Authority will serve to support the Competent Authority's continuing confidence in the aerodrome operator's competence or in the competence of the organisation responsible for the provision of AMS, or, alternatively, may lead to a breach of confidence. In the latter case, the Competent Authority will need to review any identified shortcomings of the management system, and take appropriate action if required.

## GM1 ADR.AR.C.010 Oversight programme

*ED Decision 2014/012/R*

### **PROCEDURES FOR OVERSIGHT OF AERODROME OPERATORS AND PROVIDERS OF APRON MANAGEMENT SERVICES**

In addition to its regulatory oversight the Competent Authority may establish national groups for the prevention of runway excursions and incursions as part of a national Runway Safety Steering Group. Membership of the groups could include representatives from industry such as aerodromes, aircraft operators, air traffic services, industry safety groups, (local) runway safety committee members and appropriate representatives from the Competent Authority.

The terms of reference for such a group might be to:

- Address specific hazards, identified nationally, coordinating this through sub-groups or external agencies as required;
- Promote good practice, information sharing and raise awareness through publicity and educate industry;
- Actively enhance work continuing in industry;
- Act as coordination point for industry;
- Identify and investigate which technologies are available that may reduce runway excursion and incursion risks;

- Review current aerodrome, ATC and aircraft operational policies and if necessary make recommendations on future policy to reduce the risk of runway excursions and incursions;
- Make recommendations for guidance and advisory material for industry on aerodrome, aircraft and ATC operational issues to reduce the risk of runway excursions and incursions;
- Oversee and promote the reporting of runway excursions and runway incursions incidents;
- Ensure the thorough analysis of data to identify and examine specific areas of concern.

*[applicable until 19 March 2022]*

## GM1 ADR.AR.C.010 Oversight programme

*ED Decision 2020/021/R*

### PROCEDURES FOR THE OVERSIGHT OF AERODROME OPERATORS AND OF ORGANISATIONS RESPONSIBLE FOR THE PROVISION OF AMS

In addition to its regulatory oversight, the Competent Authority may establish national groups for the prevention of runway excursions and incursions as part of a national runway safety steering group. Such groups could include representatives from industry, such as aerodrome operators, organisations responsible for the provision of AMS, aircraft operators, air traffic services providers, industry safety groups, (local) runway safety committee members and representatives from the Competent Authority.

The scope of such group might be to:

- address specific hazards, identified nationally, by coordinating actions through subgroups or external agencies, as required;
- promote good practices and information sharing, and raise awareness through publicity and by educating industry;
- actively support industry initiatives;
- act as coordination point for industry;
- identify and investigate which technologies from those that are available could reduce runway excursion and runway incursion risks;
- review current aerodrome, ATC and aircraft operational policies and, if necessary, make recommendations on future policies to reduce the risk of runway excursions and incursions;
- make recommendations for guidance and advisory material for industry on aerodrome, aircraft and ATC operational issues to reduce the risk of runway excursions and incursions;
- oversee and promote the reporting of runway excursion and runway incursion incidents;
- ensure the thorough analysis of data to identify and examine specific areas of concern.

*[applicable from 20 March 2022]*

## AMC1 ADR.AR.C.010(b) Oversight programme

*ED Decision 2014/012/R*

### AUDIT

- (a) The oversight programme should indicate which aspects will be covered with each audit.

- (b) Part of an audit should concentrate on the aerodrome operator's compliance monitoring reports to determine if the aerodrome operator is identifying the root causes and correcting its problems.
- (c) At the conclusion of the audit, an audit report should be completed by the auditing aerodrome inspector, including all findings raised.

*[applicable until 19 March 2022]*

## AMC1 ADR.AR.C.010(b) Oversight programme

*ED Decision 2020/021/R*

### AUDIT

- (a) The oversight programme should indicate which aspects will be covered with each audit.
- (b) Part of the audit should concentrate on compliance-monitoring reports to determine whether the aerodrome operator or the organisation responsible for the provision of AMS identifies the root causes and corrects its problems.
- (c) Upon conclusion of the audit, an audit report should be completed by the auditing aerodrome inspector, including all findings raised.

*[applicable from 20 March 2022]*

## AMC1 ADR.AR.C.010(b);(c) Oversight programme

*ED Decision 2014/012/R*

### OVERSIGHT PLANNING CYCLE

- (a) The safety performance should be continuously monitored in order to ensure that the oversight programme and the applicable oversight planning cycle remain appropriate.
- (b) The oversight planning cycle and related oversight programme for each aerodrome operator should be reviewed annually.
- (c) The oversight planning cycle and related oversight programme, and their annual review should be determined according to the following elements:
  - (1) the results of past certification and oversight activities;
  - (2) capability to effectively identify aviation safety hazards, and manage the associated risks;
  - (3) effective control over all changes in accordance with [ADR.OR.B.040](#);
  - (4) absence of level 1 findings;
  - (5) response time to implement corrective actions requested by the Competent Authority in accordance with [ADR.AR.C.055\(d\)\(2\)](#); and
  - (6) risk exposure related to the aerodrome operated, such as traffic volume, type of aircraft or physical characteristics of the aerodrome.
- (d) During each oversight planning cycle, the Competent Authority should convene meetings with the accountable manager of the aerodrome operator, or his/her delegate.

*[applicable until 19 March 2022]*

## AMC1 ADR.AR.C.010(b);(c) Oversight programme

ED Decision 2020/021/R

### OVERSIGHT PLANNING CYCLE

- (a) The safety performance of the aerodrome operator and the organisation responsible for the provision of AMS should be continuously monitored in order to ensure that the oversight programme and the applicable oversight planning cycle remain appropriate.
- (b) The oversight planning cycle and the related oversight programme for each aerodrome operator or for each organisation responsible for the provision of AMS should be reviewed annually.
- (c) The oversight planning cycle and the related oversight programme, including their annual review, should be determined according to the following elements:
  - (1) the results of past certification and oversight activities;
  - (2) the capability to effectively identify aviation safety hazards, and manage the associated risks;
  - (3) the effective control over all changes in accordance with point ADR.OR.B.040 for aerodrome operators and with point ADR.OR.F.025 for organisations responsible for the provision of AMS;
  - (4) the absence of level 1 findings;
  - (5) the response time to implement corrective actions requested by the Competent Authority in accordance with ADR.AR.C.055(d)(2); and
  - (6) the risk exposure related to the aerodrome operated, such as traffic volume, type of aircraft operated at the aerodrome, or physical characteristics of the aerodrome.
- (d) During each oversight planning cycle, the Competent Authority should convene meetings with the accountable manager of the aerodrome operator or the organisation responsible for the provision of AMS, or with their delegate.

*[applicable from 20 March 2022]*

## AMC2 ADR.AR.C.010(b);(c) Oversight programme

ED Decision 2014/012/R

### OVERSIGHT PLANNING CYCLE

- (a) For each aerodrome operator certified by the Competent Authority all processes should be audited at periods not exceeding the applicable oversight planning cycle. The beginning of the first oversight planning cycle is normally determined by the date of issue of the first certificate. If the Competent Authority wishes to align the oversight planning cycle with the calendar year, it should shorten the first oversight planning cycle accordingly.

*[applicable until 19 March 2022]*

- (a) For each aerodrome operator and for each organisation responsible for the provision of AMS all processes should be audited at periods not exceeding the applicable oversight planning cycle. The beginning of the first oversight planning cycle is normally determined by the date of issue of the first certificate or acknowledgement of receipt of the declaration. If the Competent Authority wishes to align the oversight planning cycle with the calendar year, it should shorten the first oversight planning cycle accordingly.

*[applicable from 20 March 2022 — ED Decision 2020/021/R]*

- (b) The interval between two audits for a particular process should not exceed the interval of the applicable oversight planning cycle.
- (c) Audits should include at least one on-site audit within each oversight planning cycle at each aerodrome.

## **GM1 ADR.AR.C.010(b) Oversight programme**

*ED Decision 2014/012/R*

### **INDUSTRY STANDARDS**

- (a) For aerodrome operators having demonstrated compliance with industry standards, the Competent Authority may adapt its oversight programme, in order to avoid duplication of specific audit items.
- (b) Demonstrated compliance with industry standards may not be considered in isolation from the other elements to be considered for the Competent Authority's risk-based oversight.
- (c) In order to be able to credit any audits performed as part of certification in accordance with industry standards, the following should be considered:
  - (1) the demonstration of compliance is based on certification auditing schemes providing for independent and systematic verification;
  - (2) the existence of an accreditation scheme and accreditation body for certification in accordance with the industry standards has been verified;
  - (3) certification audits are relevant to the requirements defined in [Part-ADR.OR](#), [Part-ADR.OPS](#), or other regulations as applicable;
  - (4) the scope of such certification audits can easily be mapped against the scope of oversight;
  - (5) audit results are accessible to the Competent Authority; and
  - (6) the audit planning intervals are compatible with the oversight planning cycle.

*[applicable until 19 March 2022]*

## **GM1 ADR.AR.C.010(b) Oversight programme**

*ED Decision 2020/021/R*

### **INDUSTRY STANDARDS**

- (a) For aerodrome operators or for organisations responsible for the provision of AMS that have demonstrated compliance with the applicable industry standards, the Competent Authority may adapt its oversight programme in order to avoid audit duplication of specific items.
- (b) The demonstration of compliance with the applicable industry standards may not be considered in isolation from the other elements to be considered for the Competent Authority's risk-based oversight.
- (c) In order to be able to credit any audits performed as part of the certification process in accordance with the applicable industry standards, the following are considered:
  - (1) the demonstration of compliance based on certification auditing schemes providing for independent and systematic verification;



- (2) the existence of an accreditation scheme and accreditation body for certification in accordance with the applicable industry standards has been verified;
- (3) the relevance of the certification audits to the requirements defined in Part-ADR.OR, in Part-ADR.OPS, or in other regulations as applicable;
- (4) the mapping of the scope of such certification audits against the scope of oversight;
- (5) the accessibility of the audit results by the Competent Authority; and
- (6) the compatibility of the audit planning intervals with the oversight planning cycle.

*[applicable from 20 March 2022]*

## GM2 ADR.AR.C.010(b) Oversight programme

*ED Decision 2014/012/R*

### FINANCIAL SITUATION

Examples of trends which may indicate problems in a new aerodrome operator's financial situation could be:

- (a) significant lay-offs or turnover of personnel; reduced staff resource; increased multi-tasking; changing shift patterns; and increased overtime;
- (b) delays in meeting payroll;
- (c) reduction of safe operating standards;
- (d) decreasing standards of training;
- (e) withdrawal of credit by suppliers;
- (f) inadequate maintenance of the aerodrome; and
- (g) shortage of supplies and spare parts.

*[applicable until 19 March 2022]*

## GM2 ADR.AR.C.010(b) Oversight programme

*ED Decision 2020/021/R*

### FINANCIAL SITUATION

Examples of trends which may indicate problems in a new aerodrome operator's financial situation or in the financial situation of an organisation responsible for the provision of AMS could be:

- (a) considerable lay-offs or turnover of personnel, reduced personnel resources, increased multi-tasking, changing shift patterns, and increased overtime;
- (b) delays in managing payments to staff;
- (c) reduction of safe operational standards;
- (d) decreasing training standards;
- (e) supplier breach of credit towards the organisation;
- (f) inadequate maintenance of the aerodrome; and
- (g) shortage of supplies and spare parts.

[applicable from 20 March 2022]

## GM3 ADR.AR.C.010(b) Oversight programme

ED Decision 2014/012/R

### PROCEDURES FOR OVERSIGHT OF AERODROME OPERATORS AND PROVIDERS OF APRON MANAGEMENT SERVICES

Normally the inspections that are carried out by the Competent Authority should be with prior notice to the aerodrome operator or the provider apron management services.

Such notice should be given in writing, and in good time before the inspection so that the inspected entity can make all the necessary arrangements and preparations, and to avoid the disruption of normal operations.

In case an inspection is conducted without prior notice (unannounced inspection), the aerodrome inspectors should ensure that the operations are affected to the minimum extent possible.

## ADR.AR.C.015 Initiation of certification process

Regulation (EU) No 139/2014

- (a) Upon receiving an application for the initial issuance of a certificate, the Competent Authority shall assess the application and shall verify compliance with the applicable requirements.
- (b) In case of an existing aerodrome, the Competent Authority shall prescribe the conditions under which the aerodrome operator shall operate during the certification period, unless the Competent Authority determines that the operation of the aerodrome needs to be suspended. The Competent Authority shall inform the aerodrome operator of the expected schedule for the certification process and conclude the certification within the shortest time period practicable.
- (c) The Competent Authority shall establish and notify the applicant of the certification basis in accordance with [ADR.AR.C.020](#).

## AMC1 ADR.AR.C.015(a) Initiation of the certification process

ED Decision 2014/012/R

### PROCESSING OF APPLICATION

Upon receipt of an application, the Competent Authority should acknowledge receipt of that application, in writing, within the period defined in the applicable national legislation.

If the Competent Authority foresees a delay in processing the application, it should notify the applicant as soon as possible, and within the period defined in the applicable national legislation.

The Competent Authority should respond to any request made by the applicant within the period defined in the applicable national legislation.

If an applicant fails to submit all necessary documentation, the Competent Authority should inform him/her in writing, within the period defined in the applicable national legislation.

## AMC1 ADR.AR.C.015(c) Initiation of the certification process

ED Decision 2014/012/R

### ESTABLISHMENT AND NOTIFICATION OF CERTIFICATION BASIS — DETERMINATION OF ELEVATION OF AERONAUTICAL BEACONS

If such beacons are operationally necessary, the Competent Authority should ensure that the elevation which is sufficient for the vertical light distribution of an aerodrome beacon or an identification beacon, as described in [CS ADR-DSN.M.620](#), is determined.

## AMC2 ADR.AR.C.015(c) Initiation of the certification process

ED Decision 2014/012/R

### ESTABLISHMENT AND NOTIFICATION OF THE CERTIFICATION BASIS

- (a) Upon receipt of the application, the Competent Authority should examine and assess the content of the application and the related documentation, including the proposed certification specifications and any provisions for which compliance is proposed to be demonstrated in a different way that provides for an equivalent level of safety. (See also paragraph (a)(2) of [AMC1 ADR.AR.C.035\(c\)](#)).
- (b) The Competent Authority should establish the certification basis of the aerodrome in accordance with [ADR.AR.C.020](#);
- (c) The Competent Authority should document and notify the applicant of:
  - (1) the certification basis as established in paragraph (b) above; and
  - (2) any change thereto, as a result of certification specifications which became effective after the notification of the certification basis and which the applicant decided to comply with, or that the Competent Authority has found necessary to be complied with, or design changes made, compliance demonstration results, new special conditions that the Competent Authority considers necessary, etc.
- (d) In addition, the Competent Authority should assess the documentation demonstrating the way the applicant is proposing to comply with the applicable requirements of the Regulation (EC) 216/2008, [Part-ADR.OR](#), and [Part-ADR.OPS](#), and any other applicable requirements that are matching the aerodrome design and its operation.
- (e) When notifying the applicant in accordance with paragraph (c), the Competent Authority should also inform him/her of the right of appeal, as exists under the applicable national legislation.

## GM1 ADR.AR.C.015 Initiation of the certification process

ED Decision 2014/012/R

### INITIAL INTEREST

Prior to initiating the application process for a certificate, the Competent Authority should arrange for a meeting with the applicant.

During this meeting, the applicant should present to the authority its plans with regard to the aerodrome. The applicant should also make arrangements so that its key personnel are present during this meeting.

In addition, during this meeting, the Competent Authority should provide general information to the applicant about the applicable requirements for the aerodrome. It should also provide copies of the

applicable requirements, application forms, and any other relevant documentation, and describe the procedures that are followed during the certification process.

Such information to be provided by the Competent Authority may also include information about approvals, permits, or clearances that the applicant may need to obtain from other competent authorities (such as security or environmental protection competent authorities, local planning authorities, etc.) of the Member State prior or during the certification process.

The Competent Authority should make arrangements so that representatives of all involved entities of the Competent Authority(ies) are present during this meeting.

## **GM1 ADR.AR.C.015(b) Initiation of the certification process**

*ED Decision 2014/012/R*

### **CERTIFICATION OF EXISTING AERODROMES**

The certification period of an existing aerodrome should not exceed 18 months from the filing of the application by the applicant to the granting of the certificate.

## **GM1 ADR.AR.C.015(c) Initiation of the certification process**

*ED Decision 2014/012/R*

### **ESTABLISHMENT AND NOTIFICATION OF THE CERTIFICATION BASIS**

Establishing the certification basis means that at the start of which the applicant proposes the certification specifications applicable to the aerodrome, the Competent Authority finalises the set of all applicable certification specifications. This means that it may change and also add additional applicable certification specifications to the applicant's proposal; this is typically an iterative process.

## **ADR.AR.C.020 Certification basis**

*Regulation (EU) No 139/2014*

The certification basis is to be established and notified to an applicant by the Competent Authority and shall consist of:

- (a) the certification specifications issued by the Agency which the Competent Authority finds applicable to the design and the type of operation of the aerodrome and which are effective on the date of application for that certificate, unless:
  - (1) the applicant elects compliance with later effective amendments; or
  - (2) the Competent Authority finds that compliance with such later effective amendments is necessary;
- (b) any provision for which an equivalent level of safety has been accepted by the Competent Authority to be demonstrated by the applicant; and
- (c) any special condition prescribed in accordance with [ADR.AR.C.025](#), that the Competent Authority finds necessary to be included in the certification basis.

## AMC1 ADR.AR.C.020(a) Certification basis

*ED Decision 2014/012/R*

### EFFECTIVE CERTIFICATION SPECIFICATIONS

- (a) The certification specifications that the Competent Authority should use to establish and notify the certification basis to the applicant, should be those that were effective during the date of the application.
- (b) Notwithstanding paragraph (a) above, if at any point of the certification process the applicant requests to use certification specifications which came into force after the filing of his/her application, or the notification of the certification basis by the Competent Authority, then the Competent Authority should examine if it is necessary to also include in the certification basis other certification specifications, which also came into effect after the filing of the initial application and which are, in the opinion of the Competent Authority, directly related to those certification specifications that have been proposed by the applicant.
- (c) Notwithstanding paragraph (a) and (b) above, the Competent Authority may at any time, after the filing of the application, decide to include in the certification basis any certification specifications that it deems necessary.

## AMC1 ADR.AR.C.020(b);(c) Certification basis

*ED Decision 2014/012/R*

### CASES OF EQUIVALENT LEVEL OF SAFETY AND SPECIAL CONDITIONS

When deciding on cases of equivalent safety or special conditions and their respective underpinning justification material, the Competent Authority may consider whether any of the applicable certification specifications compares to a Standard or a Recommended Practice and their different implications foreseen by the ICAO Convention and its Annexes.

## GM1 ADR.AR.C.020(b) Certification basis

*ED Decision 2014/012/R*

### CERTIFICATION BASIS — PROPOSALS FOR EQUIVALENT LEVEL OF SAFETY

When the Competent Authority assesses a proposal of an applicant who has requested to demonstrate an equivalent level of safety, the Competent Authority should pay, amongst others, particular attention to:

- (a) the identification of the intent of the Agency's certification specifications in question, and assess if the proposal satisfies that intent;
- (b) any possible interconnections/relationships between the Agency's certification specifications which the proposal is related to, with any other certification specifications or requirements, in order to:
  - (1) identify any implications of the proposal to other design, operational, human, or other elements of the system; and
  - (2) establish if such interconnections/relationships and implications have been properly and adequately addressed by the applicant.

The applicant's proposal may involve design, technical, procedural, or other suitable means.

The demonstration of an equivalent level of safety may involve various methodologies, quantitative or qualitative, whose magnitude and complexity may vary, depending on each case.

In any case, the applicant should demonstrate to the satisfaction of the Competent Authority that the proposed solution offers a level of safety, which is effectively not lower than that associated with the relevant Agency certification specifications.

## ADR.AR.C.025 Special conditions

*Regulation (EU) No 139/2014*

- (a) The Competent Authority shall prescribe special detailed technical specifications, named special conditions, for an aerodrome, if the related certification specifications issued by the Agency referred to in point [ADR.AR.C.020\(a\)](#) are inadequate or inappropriate, to ensure compliance with the essential requirements of Annex Va to Regulation (EC) No 216/2008, because:
  - (1) the certification specifications cannot be met due to physical, topographical or similar limitations related to the location of the aerodrome;
  - (2) the aerodrome has novel or unusual design features; or
  - (3) experience from the operation of that aerodrome or other aerodromes having similar design features has shown that safety may be endangered.
- (b) The special conditions shall contain such technical specifications, including limitations or procedures to be complied with, as the Competent Authority finds necessary to ensure compliance with the essential requirements set out in Annex Va to Regulation (EC) No 216/2008.

## ADR.AR.C.035 Issuance of certificates

*Regulation (EU) No 139/2014*

- (a) The Competent Authority may require any inspection, test, safety assessment, or exercise it finds necessary before issuing the certificate.
- (b) The Competent Authority shall issue either:
  - (1) a single aerodrome certificate; or
  - (2) two separate certificates, one for the aerodrome and one for the aerodrome operator.
- (c) The Competent Authority shall issue the certificate(s) prescribed in point (b) when the aerodrome operator has demonstrated to the satisfaction of the Competent Authority compliance with [ADR.OR.B.025](#) and [ADR.OR.E.005](#).
- (d) The certificate shall be considered to include the aerodrome's certification basis, the aerodrome manual, and, if relevant, any other operating conditions or limitations prescribed by the Competent Authority and any Deviation Acceptance and Action Documents (DAAD).
- (e) The certificate shall be issued for an unlimited duration. The privileges of the activities that the aerodrome operator is approved to conduct shall be specified in the terms of the certificate attached to it.
- (f) Where responsibilities are attributed to other relevant organisations, they should be clearly identified and listed.

- (g) Findings, other than level 1 and which have not been closed prior to the date of certification, shall be safety assessed and mitigated as necessary and a corrective action plan for the closing of the finding shall be approved by the Competent Authority.
- (h) To enable an aerodrome operator to implement changes without prior approval of the Competent Authority in accordance with [ADR.OR.B.040\(d\)](#), the Competent Authority shall approve a procedure defining the scope of such changes and describing how such changes will be managed and notified.

## GM1 ADR.AR.C.035(a) Issuance of certificates

*ED Decision 2014/012/R*

### NOMINATED PERSONS

When an aerodrome operator submits the name of a nominee for the nominated persons (see [ADR.OR.D.015](#)), the Competent Authority should assess his/her qualifications and may interview the nominee or call for additional evidence of his/her suitability.

## GM2 ADR.AR.C.035(a) Issuance of certificates

*ED Decision 2014/012/R*

### NOMINATED PERSONS - INTERVIEW WITH THE APPOINTED ACCOUNTABLE MANAGER, AND NOMINATED PERSONS

Possible cases where an interview/meeting with nominated persons may be necessary are amongst others:

- (a) start of operations before issuing a first certificate for an aerodrome; and
- (b) change of nominated persons at an aerodrome already certified.

#### Purpose of the meeting

The aim of the interview and exchange of information between the intended nominated persons and the Competent Authority is, for the latter to acquire information on the intended work areas of the nominated persons and their respective competence level so as to verify their suitability for the posts.

The purpose of the information exchange is to create good contact and understanding between the both parties, and to come to a mutual conclusion on, if necessary, possible solutions for training and personal development over time.

#### Possible agenda items:

- (a) information from the Competent Authority on organisation and mission of the Competent Authority, the regulatory framework, and specifically Safety Management System requirements;
- (b) information from the nominated person concerning the intended work area;
- (c) enforcement methodology of the Competent Authority;
- (d) the role and responsibility of the accountable manager/operational services manager/maintenance manager/ safety manager or other nominated persons;
- (e) expected competence requirement of the nominated person in relation to present personal status and experience presented in a CV or equivalent documentation;

- (f) interview/discussion concerning depth of knowledge, and understanding of the applicable legislation;
- (g) the role and responsibility of the Competent Authority and of the nominated person;
- (h) understanding of aviation in general and for the specific nominated post, how operators/activities at the aerodrome including Air Navigation Service Providers, and other aviation activities can impact aircraft safety; and
- (i) distribution of delegated powers depending on the organisational situation.

## GM3 ADR.AR.C.035(a) Issuance of certificates

*ED Decision 2014/012/R*

### **EVALUATION OF SAFETY ASSESSMENTS PROVIDED BY THE AERODROME OPERATOR AT THE INITIAL CERTIFICATION OR ACCOMPANYING A REQUEST FOR PRIOR APPROVAL OF A CHANGE IN ACCORDANCE WITH ADR.OR.B.040.**

- (a) The Competent Authority should evaluate the conclusion of a submitted safety assessment provided by the aerodrome operator to ensure compliance with the relevant requirement for the operator on how to assess changes under [ADR.OR.B.040\(f\)](#).
- (b) The Competent Authority should evaluate the safety assessment and, in particular, make sure that:
  - (1) the identified safety concern(s) has (have) been assessed through the safety assessment process and is (are) adequately documented.
  - (2) an appropriate coordination has been performed between the parties affected by the safety concern(s);
  - (3) the assessment covers the whole system and the interactions of its elements;
  - (4) the hazards have been properly identified and the level of risk assessed;
  - (5) the proposed mitigation measures are adequate and consistent with the objective of reducing the identified level of risk and the safety objectives, if relevant;
  - (6) the timeframes of the planned implementation of the proposed associated actions are appropriate.
- (c) After its evaluation, the Competent Authority should either:
  - (1) agree to the proposed associated actions, such as mitigation measures; or
  - (2) coordinate with the aerodrome operator to reach an agreement on revised mitigation measures if some risks have been underestimated, or have not been identified; or
  - (3) impose additional measures; or
  - (4) reject the proposal if no agreement can be reached.
- (d) The Competent Authority should define and undertake oversight actions that ensure that mitigation and/or additional measures are properly implemented so that the measures actually meet the risk reduction objectives, and that the planned timeframes are applied.
- (e) When necessary, the Competent Authority should require the aerodrome operator to promulgate appropriate information, for use by the aerodrome organisation, various stakeholders, and notably by the air navigation service providers and aircraft operators.



## GM1 ADR.AR.C.035(b)(1) Issuance of certificates

*ED Decision 2014/012/R*

### MODEL FOR THE SINGLE CERTIFICATE

<p>[MEMBER STATE] A Member of the European Union<sup>1</sup></p> <p>CERTIFICATE Certificate reference: [STATE CODE]: xxxxx</p> <p>Pursuant to Regulation (EC) No 216/2008 of the European Parliament and of the Council and the Commission Regulation (EC) No .../... for the time being in force and subject to the conditions specified below, [THE COMPETENT AUTHORITY OF THE MEMBER STATE<sup>2</sup>] hereby certifies that:</p> <p>[COMPANY NAME AND ADDRESS]</p> <p>is authorised to operate aerodrome [NAME OF AERODROME], in accordance with the provisions of Regulation (EC) No 216/2008 and its Implementing Rules, the aerodrome certification basis, the terms of the certificate and the aerodrome manual.</p> <p>This certificate shall remain valid for an unlimited duration, unless it is surrendered or revoked.</p> <p>Date of original issue: .....</p> <p>Revision No: .....</p> <p>Signed: .....</p> <p>For the Competent Authority [COMPETENT AUTHORITY IDENTIFICATION]</p>
--------------------------------------------------------------------------------------------------------------------------------------------------------------------------------------------------------------------------------------------------------------------------------------------------------------------------------------------------------------------------------------------------------------------------------------------------------------------------------------------------------------------------------------------------------------------------------------------------------------------------------------------------------------------------------------------------------------------------------------------------------------------------------------------------------------------------------------------------------------------------------------------------------------------------------------------------------------------------------------------------------------

## AMC1 ADR.AR.C.035(b)(2) Issuance of certificates

*ED Decision 2014/012/R*

### ISSUANCE OF SEPARATE CERTIFICATES

- (a) In case that there is a possibility to issue both separate and single certificates, the Competent Authority should act in accordance with the application made by the applicant.
- (b) In case that there is a possibility to issue separate certificates, both certificates should be issued by the same Competent Authority.
- (c) In case that an aerodrome operator operates several aerodromes, these should be listed on the aerodrome operator's certificate.

<sup>1</sup> Delete for non-EU Member States.

<sup>2</sup> Delete for non-EU Member States.

**GM1 ADR.AR.C.035(b)(2) Issuance of certificates***ED Decision 2014/012/R***MODEL FOR TWO SEPARATE CERTIFICATES — (A) AERODROME OPERATOR CERTIFICATE**

<p>[MEMBER STATE] A Member of the European Union<sup>1</sup></p> <p><b>AERODROME OPERATOR CERTIFICATE</b> Certificate reference: [STATE CODE]: xxxxx</p> <p>Pursuant to Regulation (EC) No 216/2008 of the European Parliament and of the Council and the Commission Regulation (EC) No .../... for the time being in force and subject to the conditions specified below, [THE COMPETENT AUTHORITY OF THE MEMBER STATE<sup>2</sup>] hereby certifies that:</p> <p>[COMPANY NAME AND ADDRESS]</p> <p>is authorised to operate aerodrome [NAME OF AERODROME(S)]<sup>3</sup> in accordance with the provisions of Regulation (EC) No 216/2008 and its Implementing Rules, the aerodrome certification basis, the terms of the certificate attached to the aerodrome certificate and its aerodrome manual.</p> <p>This certificate shall remain valid for an unlimited duration, unless it is surrendered or revoked.</p> <p>Date of original issue:.....</p> <p>Revision No:.....</p> <p>Signed:.....</p> <p>For the Competent Authority [COMPETENT AUTHORITY IDENTIFICATION]</p>
-----------------------------------------------------------------------------------------------------------------------------------------------------------------------------------------------------------------------------------------------------------------------------------------------------------------------------------------------------------------------------------------------------------------------------------------------------------------------------------------------------------------------------------------------------------------------------------------------------------------------------------------------------------------------------------------------------------------------------------------------------------------------------------------------------------------------------------------------------------------------------------------------------------------------------------------------------------------------------------------------------------------------------------------------------------------------------------------

**MODEL FOR THE TWO SEPARATE CERTIFICATES — (B) AERODROME CERTIFICATE**

<p>[MEMBER STATE] A Member of the European Union<sup>4</sup></p> <p><b>AERODROME CERTIFICATE</b> Certificate reference: [STATE CODE]: xxxxx</p> <p>Pursuant to Regulation (EC) No 216/2008 of the European Parliament and of the Council and the Commission Regulation (EC) No .../... for the time being in force and subject to the conditions specified below, [THE COMPETENT AUTHORITY OF THE MEMBER STATE] hereby certifies that:</p>
----------------------------------------------------------------------------------------------------------------------------------------------------------------------------------------------------------------------------------------------------------------------------------------------------------------------------------------------------------------------------------------------------------------------------------------------------

<sup>1</sup> Delete for non-EU Member States.

<sup>2</sup> Delete for non-EU Member States.

<sup>3</sup> Delete as appropriate. If the operator operates more than one aerodrome, all aerodromes shall be listed.

<sup>4</sup> Delete for non-EU Member States.

[NAME OF AERODROME<sup>1</sup>]

is authorised to be operated as an aerodrome by [AERODROME OPERATOR COMPANY NAME AND ADDRESS], in accordance with the provisions of Regulation (EC) No 216/2008 and its Implementing Rules, the aerodrome certification basis, the terms of the certificate attached to this aerodrome certificate and the aerodrome manual.

This certificate shall remain valid for an unlimited duration, unless it is surrendered or revoked.

Date of original issue:.....

Revision No:.....

Signed:.....

For the Competent Authority [COMPETENT AUTHORITY IDENTIFICATION]

## AMC1 ADR.AR.C.035(c) Issuance of certificates

*ED Decision 2014/012/R*

### VERIFICATION OF COMPLIANCE

- (a) Upon receipt of an application for a certificate, the Competent Authority should:
- (1) nominate an individual to become the focal point for all aspects of the applicant's certification process, and to coordinate all necessary activities, including the Competent Authority's certification team. The nominated person should be responsible to the responsible person of the Competent Authority for confirming that all appropriate inspections and audits have been carried out. He/she should also ensure that the necessary prior approvals required are issued in due course;
  - (2) verify if the application shows compliance with the applicable requirements. The Competent Authority should also arrange for the steps to be followed during the certification process. This would, normally, start with the demonstration of compliance of the aerodrome with the established and notified certification basis (see [AMC2 ADR.AR.C.015\(c\)](#)) which will require the conduct of technical inspections by the Competent Authority and/or examination of submitted documentation, the participation to demonstrations, or tests conducted by the applicant, as the case may be, and the Competent Authority determines appropriate. This should also include the cases where the certification basis includes provisions for which the Competent Authority has accepted the applicant to demonstrate an equivalent level of safety to, or cases of special conditions, as applicable;

If the Competent Authority is not satisfied with the outcome of the demonstration process for any elements of the certification basis, it should notify the applicant in writing. At the end of this phase, the Competent Authority should have documented evidence that the aerodrome meets the notified certification basis;

<sup>1</sup> Delete as appropriate.

- (3) review the aerodrome manual, which should be prepared in accordance with [ADR.OR.D.005](#), and any other documentation provided by the applicant; and
  - (4) verify compliance with the applicable requirements of [Part-ADR.OR](#), [Part-ADR.OPS](#), as well as any other applicable requirement. When verifying compliance with such requirements, an audit should be conducted covering the following areas:
    - (i) compliance shown by the applicant with the applicable requirements of [Part-ADR.OPS](#), or any other applicable requirements;
    - (ii) the applicant's management system and its organisation, including: detailed management structure, including names and qualifications of nominated personnel; adequacy of the organisation and management structure, including allocated resources and numbers of personnel allocated by the applicant to key management tasks and other positions. Care should be taken to verify that the system is comprehensive, and is likely to be effective. Of particular importance is a careful review of the qualifications of the applicant's nominated persons. Account should be taken of the relevance of the nominee's previous experience and known record;
    - (iii) safety management and compliance monitoring with applicable requirements;
    - (iv) documentation on which the certificate should be granted (organisation documentation as required by [Part-ADR.OR](#), including technical manuals, such as the aerodrome manual etc.); and
    - (v) adequacy of facilities with regard to the applicant's scope of work.
  - (5) in case of non-compliance, the applicant should be informed, in writing, of the corrections or supplements which are required.
- (b) The Competent Authority should be satisfied with the demonstration of compliance of the aerodrome manual with the requirements referred to in [ADR.OR.E.005](#) and the related AMCs.
  - (c) The Competent Authority should ensure that standardised and approved methods and tools are used by its personnel during the process described in paragraph a.
  - (d) In cases where an application for a certificate is refused, the applicant should be informed of the right of appeal existing under national regulations.
  - (e) Prior to issuing the certificate(s), the Competent Authority may require the conduct of one or more flights at the aerodrome, as well as any other test, or exercise it finds necessary.
  - (f) When the verification process is complete, the Competent Authority should issue the certificate(s) and ensure the publication of the certification status of the aerodrome in the aeronautical information publication (AIP).

## GM1 ADR.AR.C.035(c) Issuance of certificates

*ED Decision 2014/012/R*

### VERIFICATION OF COMPLIANCE

The technical inspections of the aerodrome should take place prior to the Competent Authority finding the aerodrome manual satisfactory in accordance with [ADR.OR.E.005](#).

## AMC1 ADR.AR.C.035(d) Issuance of certificates

*ED Decision 2014/012/R*

### OPERATING CONDITIONS OR LIMITATIONS

- (a) If, during the certification process, an operating condition or a limitation has been determined as necessary to be imposed on or implemented at the aerodrome, the Competent Authority should ensure that such limitation or procedure is also included in the aerodrome manual.
- (b) The Competent Authority should also ensure that the aerodrome manual contains all limitations, or any other similar information prescribed in the certification specifications included in the certification basis of the aerodrome.

## AMC2 ADR.AR.C.035(d) Issuance of certificates

*ED Decision 2014/012/R*

### OPERATING CONDITIONS OR LIMITATIONS

- (a) Operating conditions and limitations, such as noise mitigation or abatement procedures, should not increase, but should seek to reduce where possible, the risk of runway incursions and excursions.
- (b) Operating conditions and limitations should undergo a safety risk assessment to determine if they may adversely affect runway incursion and excursion risk levels.

## GM1 ADR.AR.C.035(d) Issuance of certificates

*ED Decision 2014/012/R*

### SCOPE OF AIRCRAFT OPERATIONS WITH A HIGHER AERODROME REFERENCE CODE LETTER

Any restrictions or mitigation measures for the use of aircraft type/s at the aerodrome should only be mentioned in the aerodrome manual. Notably any limitations arising from the assessment to be undertaken for the use of the aerodrome by higher code letter aircraft according to [ADR.OPS.B.090](#) should be included there.

## GM1 ADR.AR.C.035(e) Issuance of certificates

*ED Decision 2014/012/R*

### MODEL FOR THE TERMS OF THE CERTIFICATE TO BE ATTACHED TO THE CERTIFICATES

TERMS OF THE CERTIFICATE	
Certificate reference: [STATE CODE] <sup>1</sup> :	
Aerodrome name — ICAO location indicator <sup>2</sup> :	
Conditions to operate <sup>3</sup> :	
Runway — declared distances <sup>4</sup> :	
Types of approaches <sup>5</sup> :	
Aerodrome reference code <sup>6</sup> :	

Scope of aircraft operations with a higher aerodrome reference code letter <sup>7</sup> :	
Provision of apron management services <sup>8</sup> :	
Rescue and firefighting level of protection <sup>9</sup> :	
Other <sup>10</sup>	

- <sup>1</sup> The certificate must be given the State Code [The two-letter ISO code should be used (ISO 3166 alpha-2), except for Greece and the United Kingdom, for which the abbreviations EL and UK are recommended] and a unique ascending number. Example: EL – 001
- <sup>2</sup> To be specified: the official name of the aerodrome and the ICAO location indicator for the aerodrome.
- <sup>3</sup> To be specified: day/ night and IFR/ VFR.
- <sup>4</sup> To be specified: ASDA, LDA, TODA, TORA in metres for each direction of each runway, including intersection take-off if applicable.
- <sup>5</sup> To be specified: approval of the runway for non-instrument, instrument, non-precision approach. In case of precision approach (-es) it is to be indicated, which of the following precision approach (-es) is (are) approved:
- Standard Category I;
  - Lower than Standard Category I;
  - Precision Approach Category II;
  - Other than Standard Category II;
  - Precision Approach Category III-A;
  - Precision Approach Category III-B;
  - Precision Approach Category III-C.
- <sup>6</sup> To be specified: Aerodrome Reference Code (Code number/Code letter).
- <sup>7</sup> To be specified: the approved type of aeroplanes with a higher code letter than indicated in point 7 above.
- <sup>8</sup> To be specified: the name of the service provider, both in case such services are t or are not provided by the aerodrome operator.
- <sup>9</sup> To be specified: the rescue and firefighting level of protection as per Annex IV ([Part-ADR.OPS](#)) of this Regulation.
- <sup>10</sup> To be specified: any other information that the Competent Authority finds necessary to include.

*[applicable until 11 August 2021]*

## GM1 ADR.AR.C.035(e) Issuance of certificates

ED Decision 2021/003/R

### MODEL FOR THE TERMS OF THE CERTIFICATE TO BE ATTACHED TO THE CERTIFICATES

TERMS OF THE CERTIFICATE	
Certificate reference: [STATE CODE] <sup>1</sup> :	
Aerodrome name — ICAO location indicator <sup>2</sup> :	
Conditions to operate <sup>3</sup> :	
Operations on specially prepared winter runways <sup>4</sup>	
Runway — declared distances <sup>5</sup> :	
Types of approaches <sup>6</sup> :	
Aerodrome reference code <sup>7</sup> :	
Scope of aircraft operations with a higher aerodrome reference code letter <sup>8</sup> :	
Provision of apron management services <sup>9</sup> :	
Rescue and firefighting level of protection <sup>10</sup> :	

<sup>1</sup> The certificate must be given the State Code [The two-letter ISO code should be used (ISO 3166 alpha-2), except for Greece and the United Kingdom, for which the abbreviations EL and UK are recommended] and a unique ascending number. Example: EL – 001

<sup>2</sup> To be specified: the official name of the aerodrome and the ICAO location indicator for the aerodrome.

<sup>3</sup> To be specified: day/ night and IFR/ VFR.

<sup>4</sup> To be specified: (yes/no). See [ADR.OPS.B.036](#).

<sup>5</sup> To be specified: ASDA, LDA, TODA, TORA in metres for each direction of each runway, including intersection take-off if applicable.

<sup>6</sup> To be specified: approval of the runway for non-instrument, instrument, non-precision approach. In case of precision approach (-es) it is to be indicated, which of the following precision approach (-es) is (are) approved:

- Standard Category I;
- Lower than Standard Category I;
- Precision Approach Category II;
- Other than Standard Category II;
- Precision Approach Category III-A;
- Precision Approach Category III-B;

- Precision Approach Category III-C.
- <sup>7</sup> To be specified: Aerodrome Reference Code (Code number/Code letter).
- <sup>8</sup> To be specified: the approved type of aeroplanes with a higher code letter than indicated in point 7 above.
- <sup>9</sup> To be specified: the name of the service provider, both in case such services are t or are not provided by the aerodrome operator.
- <sup>10</sup> To be specified: the rescue and firefighting level of protection as per Annex IV (Part-ADR.OPS) to this Regulation.

*[applicable from 12 August 2021]*

## AMC1 ADR.AR.C.035(h) Issuance of certificates

*ED Decision 2014/012/R*

### APPROVAL OF THE PROCEDURE FOR THE MANAGEMENT AND NOTIFICATION OF CHANGES

The Competent Authority should establish and document its process to be followed by the aerodrome inspectors when assessing the scope of the changes in the procedure proposed by the aerodrome operator to be followed for the management and notification of the changes. Criteria to be used include, but are not limited to:

- (a) frequency of changes;
- (b) magnitude of changes;
- (c) complexity of the aerodrome and type of operations;
- (d) density of traffic at the aerodrome;
- (e) time required to assess the documentation of the changes notified by the aerodrome operator;
- (f) reasonable reaction times in relation to types of changes for the Competent Authority to object to a notification;
- (g) need for the timely publication of the changes and their notification by the AIRAC system;
- (h) previous conduct of the aerodrome operator; and
- (i) effectiveness of the safety management system of the aerodrome operator.

## ADR.AR.C.040 Changes *[until 19 March 2022]*

## ADR.AR.C.040 Changes — aerodrome operator *[from 20 March 2022 — Delegated Regulation (EU) 2020/1234]*

*Regulation (EU) No 139/2014*

- (a) Upon receiving an application for a change, in accordance with [ADR.OR.B.40](#), that requires prior approval, the Competent Authority shall assess the application and, if relevant, notify the aerodrome operator of:
  - (1) the applicable certification specifications issued by the Agency, which are applicable to the proposed change and which are effective on the date of the application, unless:



- (a) the applicant elects compliance with later effective amendments; or
- (b) the Competent Authority finds that compliance with such later effective amendments is necessary;
- (2) any other certification specification issued by the Agency that the Competent Authority finds is directly related to the proposed change;
- (3) any special condition, and amendment to special conditions, prescribed by the Competent Authority in accordance with point [ADR.AR.C.025](#), the Competent Authority finds is necessary; and
- (4) the amended certification basis, if affected by the proposed change.
- (b) The Competent Authority shall approve the change when the aerodrome operator has demonstrated, to the satisfaction of the Competent Authority, compliance with the requirements in [ADR.OR.B.040](#) and, if applicable, with [ADR.OR.E.005](#).
- (c) If the approved change affects the terms of the certificate, the Competent Authority shall amend them.
- (d) The Competent Authority shall approve any conditions under which the aerodrome operator shall operate during the change.
- (e) Without prejudice to any additional enforcement measures, when the aerodrome operator implements changes requiring prior approval without having received Competent Authority approval as defined in (a), the Competent Authority shall consider the need to suspend, limit or revoke the certificate.
- (f) For changes not requiring prior approval, the Competent Authority shall assess the information provided in the notification sent by the aerodrome operator in accordance with [ADR.OR.B.040\(d\)](#) to verify their appropriate management and verify their compliance with the certification specifications and other appropriate requirements applicable to the change. In case of any non-compliance, the Competent Authority shall:
  - (1) notify the aerodrome operator about the non-compliance and request further changes; and
  - (2) in case of level 1 or level 2 findings, act in accordance with point [ADR.AR.C.055](#).

**AMC1 ADR.AR.C.040(a) Changes [until 19 March 2022]/Changes — aerodrome operator [from 20 March 2022 — ED Decision 2020/021/R]**

*ED Decision 2014/012/R*

#### **EFFECTIVE CERTIFICATION SPECIFICATIONS FOR CHANGES**

- (a) The certification specifications that the Competent Authority should use to assess the application for or the notification of a change, should be those which were effective on the date of the notification of the change by the aerodrome operator.
- (b) Notwithstanding paragraph (a) above, at any point of the process the aerodrome operator may request to use certification specifications that came into force after the filing of the application for, or notification of a change. In such cases, the Competent Authority should examine if it is necessary to also notify the aerodrome operator of other certification specifications, which also came into effect after the date of the application for, or the notification of the change by the

aerodrome operator, and which are, in the opinion of the Competent Authority, directly related to those already identified as being affected by the change.

- (c) Notwithstanding paragraph (a) and (b) above, the Competent Authority may at any time, after the application or notification of a change by the aerodrome operator, decide to notify the aerodrome operator of any certification specifications that it deems necessary for the proposed change.

**AMC2 ADR.AR.C.040(a) Changes [until 19 March 2022]/Changes — aerodrome operator [from 20 March 2022 — ED Decision 2020/021/R]**

*ED Decision 2014/012/R*

**CHANGES REQUIRING PRIOR APPROVAL**

- (a) Upon receiving an application for a proposed change that requires a prior approval, the Competent Authority should, in due time:
- (1) assess the proposed change in relation to the certification basis, and the applicable requirements of [Part-ADR.OR](#), [Part-ADR.OPS](#), as well as any other applicable requirements;
  - (2) assess if the aerodrome operator has identified all the applicable certification specifications, applicable requirements of [Part-ADR.OR](#), [Part-ADR.OPS](#), or other applicable requirements which are related to or affected by the change, as well as any proposal of the applicant for the demonstration of an equivalent level of safety;
  - (3) assess the actions proposed by the aerodrome operator in order to show compliance with (1) and (2) above;
  - (4) review and assess the content of proposed changes to the aerodrome manual; and
  - (5) evaluate the safety assessment that has been submitted by the aerodrome operator, in accordance with [GM3 ADR.AR.C.035\(a\)](#) and verify its compliance with [ADR.OR.B.040\(f\)](#).
- (b) The Competent Authority should also determine, in due time:
- (1) if the proposed change is directly related to any other certification specification which had been included in the certification basis. If the Competent Authority finds such a relationship, it should include these related certification specifications amongst those to be notified to the applicant; and
  - (2) if the proposed change is such that a special condition, or an amendment to an existing special condition is required.
- (c) The Competent Authority should document and notify, in writing, the aerodrome operator, in due time, of:
- (1) the certification specifications that it has identified to be applicable in accordance with the previous paragraphs (a) and (b);
  - (2) any provisions for which the Competent Authority has accepted the applicant to demonstrate an equivalent level of safety; and
  - (3) any special conditions, or amendments to special conditions it finds necessary.

- (d) Any subsequent changes to the items mentioned in paragraph (c), should be documented and notified to the aerodrome operator, in writing, in due time.
- (e) The Competent Authority should, in due time, verify the compliance of the aerodrome operator and, depending on the change, examine the need for prescribing any condition for the operation of the aerodrome during the change.
- (f) When notifying the aerodrome operator in accordance with paragraph (c) or (d), the Competent Authority should also inform him/her of the right of appeal, as exists under the applicable national legislation.

**AMC1 ADR.AR.C.040(a);(f) Changes [until 19 March 2022]/Changes — aerodrome operator [from 20 March 2022 — ED Decision 2020/021/R]**

ED Decision 2014/012/R

**GENERAL**

- (a) Changes in nominated persons: The Competent Authority should be informed of any changes to nominated persons (see [ADR.OR.D.015](#)) that may affect the certificate or the terms of approval attached to it. When an aerodrome operator submits the name of a nominee for the nominated persons, the Competent Authority should assess his/her qualifications, and may interview the nominee, or call for additional evidence of his/her suitability. (see [GM1 ADR.AR.C.035\(a\)](#)).
- (b) The Competent Authority should receive from the aerodrome operator each management system documentation amendment, including amendments that do not require prior approval by the Competent Authority. A documented systematic approach should be used for maintaining the information on when an amendment was received by the Competent Authority and when it was approved.
- (c) Where the amendment requires the Competent Authority's approval, the Competent Authority, when satisfied, should indicate its approval in writing. Where the amendment does not require prior approval, the Competent Authority should acknowledge receipt in writing within the time limits existing under the relevant national legislation.
- (d) For changes requiring prior approval, in order to verify the aerodrome operator's compliance with the applicable requirements, the Competent Authority should consider the need to conduct an audit of the operator, limited to the extent of the changes. If required for verification, the audit should include additional interviews and inspections carried out at the aerodrome operator's facilities.

**GM1 ADR.AR.C.040(c) Changes [until 19 March 2022]/Changes — aerodrome operator [from 20 March 2022 — ED Decision 2020/021/R]**

ED Decision 2014/012/R

**AMENDMENTS TO THE TERMS OF THE CERTIFICATE**

The Competent Authority should amend the terms of the certificate when the terms have changed, irrespective of the magnitude of the change.

## GM1 ADR.AR.C.040(d) Changes [until 19 March 2022]/Changes — aerodrome operator [from 20 March 2022 — ED Decision 2020/021/R]

ED Decision 2014/012/R

### CONDITIONS UNDER WHICH TO OPERATE DURING A CHANGE

The conditions or limitations under which an aerodrome operator can operate during a change should be approved by the authority but should usually be elaborated between the operator and the authority upon suggestion of the aerodrome operator.

## ADR.AR.C.050 Declarations of providers of apron management services

Regulation (EU) No 139/2014

- (a) Upon receiving a declaration from a provider of apron management services intending to provide such services at an aerodrome, the Competent Authority shall verify that the declaration contains all the information required by [Part-ADR.OR](#) and shall acknowledge receipt of the declaration to that organisation.
- (b) If the declaration does not contain the required information, or contains information that indicates non-compliance with applicable requirements, the Competent Authority shall notify the provider of apron management services and the aerodrome operator about the non-compliance and request further information. If necessary, the Competent Authority shall carry out an inspection of the provider of apron management services and the aerodrome operator. If the non-compliance is confirmed, the Competent Authority shall take action as defined in [ADR.AR.C.055](#).
- (c) The Competent Authority shall keep a register of the declarations of providers of apron management services under its oversight.

[applicable until 19 March 2022]

## ADR.AR.C.050 Declaration of organisations responsible for the provision of AMS and notification of a change

Delegated Regulation (EU) 2020/1234

- (a) Upon receiving a declaration from an organisation responsible for the provision of AMS that intends to provide such a service at an aerodrome, or upon receiving a notification of a change to the information contained in the declaration, the Competent Authority shall acknowledge receipt of the declaration or the notification of a change, and shall verify that the declaration or the notification contains all the information required by [Annex III](#) (Part-ADR.OR).
- (b) If the declaration or the notification of a change does not contain all the information required under point [ADR.OR.F.005](#) of Annex III, or contains information that is not in accordance with the applicable requirements, the Competent Authority shall notify the organisation responsible for the provision of AMS and the aerodrome operator where such service is provided about the non-compliance and request further information. If deemed necessary the competent authority shall carry out an inspection of the organisation. If the non-compliance is confirmed, the Competent Authority shall take action as defined in point [ADR.AR.C.055](#) of this Annex.

- (c) The Competent Authority shall keep a register of the declarations and of the notifications of a change of the organisation responsible for the provision of AMS under its oversight.

*[applicable from 20 March 2022]*

## GM1 ADR.AR.C.050 Declarations of providers of apron management services *[until 19 March 2022]*/Declaration of organisations responsible for the provision of AMS and notification of a change *[from 20 March 2022 — ED Decision 2020/021/R]*

*ED Decision 2014/012/R*

### VERIFICATION OF COMPLIANCE — DECLARATIONS

The verification made by the Competent Authority upon receipt of a declaration does not necessarily imply an inspection. The primary aim is to check whether what is declared complies with applicable requirements.

## ADR.AR.C.055 Findings, observations, corrective actions and enforcement measures

*Regulation (EU) No 139/2014*

- (a) The Competent Authority for oversight in accordance with [ADR.AR.C.005\(a\)](#) shall have a system to analyse findings for their safety significance.
- (b) A level 1 finding shall be issued by the Competent Authority when any significant non-compliance is detected with the certification basis of the aerodrome, the applicable requirements of Regulation (EC) No 216/2008 and its Implementing Rules, with the aerodrome operator's or the apron management services provider's procedures and manuals, with the terms of the certificate or certificate or with the content of a declaration which lowers safety or seriously endangers safety.

The level 1 finding shall include:

- (1) failure to give the Competent Authority access to the aerodrome and aerodrome operator's or the apron management services provider's facilities as defined in [ADR.OR.C.015](#) during normal operating hours and after two written requests;
  - (2) obtaining or maintaining the validity of a certificate by falsification of submitted documentary evidence;
  - (3) evidence of malpractice or fraudulent use of a certificate; and
  - (4) the lack of an accountable manager.
- (c) A level 2 finding shall be issued by the Competent Authority when any non-compliance is detected with the certification basis of the aerodrome, the applicable requirements of Regulation (EC) No 216/2008 and its Implementing Rules, with the aerodrome operator's or the apron management services provider's procedures and manuals, with the terms of the certificate or the certificate or with the content of a declaration which could lower or possibly hazard safety.
- (d) When a finding is detected, during oversight or by any other means, the Competent Authority shall, without prejudice to any additional action required by Regulation (EC) No 216/2008 and

its Implementing Rules, communicate the finding to the aerodrome operator or the provider of apron management services in writing and request corrective action to address the non-compliance(s) identified.

- (1) In the case of level 1 findings, the Competent Authority shall take immediate and appropriate action to prohibit or limit activities, and if appropriate, it shall take action to revoke the certificate or to deregister the declaration, or to limit or suspend the certificate or declaration in whole or in part, depending upon the extent of the finding, until successful corrective action has been taken by the aerodrome operator or by the provider of apron management services.
  - (2) In the case of level 2 findings, the Competent Authority shall:
    - (a) grant the aerodrome operator or the provider of apron management services a corrective action implementation period included in an action plan appropriate to the nature of the finding; and
    - (b) assess the corrective action and implementation plan proposed by the aerodrome operator or the provider of apron management services and, if the assessment concludes that they are sufficient to address the non-compliance(s), accept these.
  - (3) Where the aerodrome operator or the provider of apron management services fails to submit an acceptable corrective action plan, or to perform the corrective action within the time period accepted or extended by the Competent Authority, the finding shall be raised to a level 1 finding, and action taken as laid down in point (d)(1).
  - (4) The Competent Authority shall record all findings it has raised and where applicable, the enforcement measures it has applied, as well as all corrective actions and date of action closure for findings.
- (e) For those cases not requiring level 1 or level 2 findings, the Competent Authority may issue observations.
- (f) Any findings issued with regard to an organisation responsible for the provision of AMS or any observations made to the organisation responsible for the provision of AMS shall be notified by the Competent Authority to the operator of the aerodrome where such service is provided.

*[point (f) applicable from 20 March 2022 — Delegated Regulation (EU) 2020/1234]*

## **GM1 ADR.AR.C.055 Findings, observations, corrective actions, and enforcement measures**

*ED Decision 2014/012/R*

### **ENFORCEMENT MEASURES — FINANCIAL PENALTIES**

The Competent Authority may additionally, and depending on the nature and the repetitiveness of the findings, or the level of implementation of the corrective actions, impose financial penalties as appropriate, which are effective, proportionate, and dissuasive.

## GM2 ADR.AR.C.055 Findings, observations, corrective actions, and enforcement measures

*ED Decision 2014/012/R*

### **TRAINING**

For a level 1 finding, it may be necessary for the Competent Authority to ensure that further training by the aerodrome operator, or the provider of the apron management services is carried out, and audited by the Competent Authority before the activity is resumed, dependent upon the nature of the finding.

## GM3 ADR.AR.C.055 Findings, observations, corrective actions, and enforcement measures

*ED Decision 2014/012/R*

### **CATEGORIES OF FINDINGS — DOCUMENTARY EVIDENCE**

Examples of documentary evidence include, but are not limited to:

- (a) aerodrome or equipment manuals;
- (b) contracts or other types of arrangements;
- (c) training, qualification, or medical records;
- (d) inspection records;
- (e) test or exercise results;
- (f) internal audit results;
- (g) maintenance records; and
- (h) other similar material required to be maintained by the aerodrome operator, or the provider of apron management services.

## ANNEX III — PART-ADR.OR

### PART ORGANISATION REQUIREMENTS — AERODROME OPERATORS (PART-ADR.OR) [UNTIL 19 MARCH 2022] / PART ORGANISATION REQUIREMENTS (PART-ADR.OR) [FROM 20 MARCH 2022 — DELEGATED REGULATION (EU) 2020/1234]

#### SUBPART A — GENERAL REQUIREMENTS (ADR.OR.A)

##### ADR.OR.A.005 Scope

Regulation (EU) No 139/2014

This Annex establishes the requirements to be followed by:

- (a) an aerodrome operator subject to Regulation (EC) No 216/2008 with respect to its certification, management, manuals and other responsibilities; and
- (b) a provider of apron management services.

##### ADR.OR.A.010 Competent Authority

Regulation (EU) No 139/2014

For the purpose of this Part, the Competent Authority shall be the one designated by the Member State where the aerodrome is located.

##### ADR.OR.A.015 Means of compliance

Regulation (EU) No 139/2014

- (a) Alternative means of compliance to those adopted by the Agency may be used by an aerodrome operator or an apron management service provider to establish compliance with Regulation (EC) No 216/2008 and its Implementing Rules.
- (b) When an aerodrome operator or an apron management service provider wishes to use an alternative means of compliance to the Acceptable Means of Compliance (AMC) adopted by the Agency to establish compliance with Regulation (EC) No 216/2008 and its Implementing Rules, it shall, prior to implementing it, provide the Competent Authority with a full description of the alternative means of compliance. The description shall include any revisions to manuals or procedures that may be relevant, as well as an assessment demonstrating that the Implementing Rules are met.

The aerodrome operator or the provider of apron management services may implement these alternative means of compliance subject to prior approval by the Competent Authority and upon receipt of the notification, as prescribed in [ADR.AR.A.015\(d\)](#).

- (c) Where apron management services are not provided by the aerodrome operator itself, the use of alternative means of compliance by providers of such services in accordance with (a) and (b), shall also require prior agreement by the operator of the aerodrome where such services are provided.



## AMC1 ADR.OR.A.015 Means of compliance

*ED Decision 2014/012/R*

### **DEMONSTRATION OF COMPLIANCE**

In order to demonstrate that the Implementing Rules are met, a safety (risk) assessment should be completed and documented. The result of this safety (risk) assessment should demonstrate that an equivalent level of safety to that established by the Acceptable Means of Compliance (AMC) adopted by the Agency is reached.

## SUBPART B — CERTIFICATION (ADR.OR.B) [UNTIL 19 MARCH 2022] / SUBPART B — CERTIFICATION — AERODROMES AND AERODROME OPERATORS (ADR.OR.B) [FROM 20 MARCH 2022 — DELEGATED REGULATION (EU) 2020/1234]

### ADR.OR.B.005 Certification obligations of aerodromes and aerodrome operators

Regulation (EU) No 139/2014

Prior to commencing the operation of an aerodrome or when an exemption in accordance with [Article 5](#) has been revoked, the aerodrome operator shall obtain the applicable certificate(s) issued by the Competent Authority.

### ADR.OR.B.015 Application for a certificate

Regulation (EU) No 139/2014

- (a) The application for a certificate shall be made in a form and manner established by the Competent Authority.
- (b) The applicant shall provide the Competent Authority with the following:
  - (1) its official name and business name, address, and mailing address;
  - (2) information and data regarding:
    - (i) the location of the aerodrome;
    - (ii) the type of operations at the aerodrome; and  
*[applicable until 26 January 2022]*
    - (ii) the type of operations at the aerodrome and the associated airspace; and  
*[applicable from 27 January 2022 — Implementing Regulation (EU) 2020/469]*
    - (iii) the design and facilities of the aerodrome, in accordance with the applicable certification specifications established by the Agency;
  - (3) any proposed deviations from the identified applicable certification specifications established by the Agency;
  - (4) documentation demonstrating how it will comply with the applicable requirements established in Regulation (EC) No 216/2008 and its Implementing Rules. Such documentation shall include a procedure, contained in the aerodrome manual, describing how changes not requiring prior approval will be managed and notified to the Competent Authority; subsequent changes to this procedure shall require prior approval by the Competent Authority;
  - (5) evidence of adequacy of resources to operate the aerodrome in accordance with the applicable requirements;

- (6) documented evidence showing the relationship of the applicant with the aerodrome owner and/or the land owner;
  - (7) the name of and relevant information about the accountable manager and the other nominated persons required by [ADR.OR.D.015](#); and
  - (8) a copy of the aerodrome manual required by [ADR.OR.E.005](#).
- (c) If acceptable to the Competent Authority, information under points (7) and (8) may be provided at a later stage determined by the Competent Authority, but prior to the issuance of the certificate.

## GM1 ADR.OR.B.015 Application for a certificate

*ED Decision 2014/012/R*

### INITIAL INTEREST

Prior to submitting an application for a certificate to the Competent Authority, an applicant should arrange for a meeting with the Competent Authority.

The applicant should also make arrangements for its key personnel to be present during this meeting.

During this meeting, the applicant should present to the authority its plans with regard to the aerodrome.

During the meeting, the applicant may be:

- (a) provided by the Competent Authority with general information about the applicable requirements for the aerodrome;
- (b) provided with copies of the applicable requirements, and a description of the procedures that are followed during the certification process; and
- (c) informed by the Competent Authority about possible approvals, permits, or clearances that may be needed to be obtained from other competent authorities of the Member State.

## AMC1 ADR.OR.B.015(a) Application for a certificate

*ED Decision 2014/012/R*

### APPLICATION

The application should be made in writing, and be signed by the applicant, using a standardised form established by the Competent Authority.

## AMC1 ADR.OR.B.015(b)(1);(2);(3);(4) Application for a certificate

*ED Decision 2014/012/R*

### INFORMATION TO BE PROVIDED TO THE COMPETENT AUTHORITY

- (a) The applicant should:
  - (1) provide its telephone, and fax number, and e-mail address for communication with the Competent Authority;

- 
- (2) indicate the names of its employees whom the Competent Authority would contact in order to address any issues that might arise during the evaluation of the application, and the certification process.
- (b) The applicant should provide the Competent Authority with the following:
- (1) information about the location of the aerodrome: the exact location of the aerodrome should be depicted on a map of a suitable scale acceptable to the Competent Authority;
  - (2) information about the type of operations at the aerodrome, including:
    - (i) operations during the day and/or night, and type of approaches;
    - (ii) landing, and/or take-off operations on each runway;
    - (iii) the aircraft types to be served at the aerodrome, and the aircraft type to be used for the design of the aerodrome; and
    - (iv) any limitations to the operation of the aerodrome.
  - (3) the drawing(s) showing the design of the aerodrome, which should:
    - (i) be in a suitable scale, acceptable to the Competent Authority;
    - (ii) be in an electronic format if this is acceptable to the Competent Authority.
    - (iii) contain all the necessary information, including:
      - (A) runway(s) orientation;
      - (B) the dimensions of the aerodrome's physical characteristics;
      - (C) the visual and non-visual aids;
      - (D) the obstacle limitation surfaces, and any other surfaces applicable; and
      - (E) the aerodrome facilities, installations, and fixed equipment and their location.
  - (4) description, height, and location of obstacles, in accordance with the applicable aeronautical data requirements (see [ADR.OPS.A.005](#) and [AMC1 ADR.OPS.A.005](#)).
- (c) The applicant should identify the applicable certification specifications for the design and type of operations of the proposed aerodrome and provide the Competent Authority with evidence that the proposed design and operation complies with them. If relevant, the applicant should also provide the Competent Authority with:
- (1) the certification specifications for which it proposes to show compliance in a different manner and demonstrate an equivalent level of safety. Such a proposal has to be acceptable to the Competent Authority. In such cases, the applicant should also propose the method that will be used to demonstrate compliance and achieve an equivalent level of safety, and submit all necessary documentation to support the proposal;
  - (2) any other proposal for which the applicant assumes that the certification specifications issued by the Agency are inadequate or inappropriate.

- (d) The applicant should provide the Competent Authority documentation to demonstrate how it will comply with the applicable requirements of the Basic Regulation, [Part-ADR.OR](#), and [Part-ADR.OPS](#), and any other applicable requirements that are matching the aerodrome design and its operation.

## GM1 ADR.OR.B.015(b)(2) Application for a certificate

*ED Decision 2014/012/R*

### AERODROME BOUNDARIES

The map submitted with the application should indicate the boundary of the aerodrome area. It should include, at least, runways, taxiways, aprons, associated strips, runway end safety areas, stopways, clearways, aerodrome visual aids, fixed aerodrome equipment, other aerodrome operational areas, areas adjacent to the movement area, etc, while maintenance areas may be excluded if acceptable to the Competent Authority.

The above aerodrome boundary should not be confused with the boundaries established for other purposes, such as fences, the land ownership boundaries used by local planning authorities, or those used to designate security restricted zones.

## GM1 ADR.OR.B.015(b)(2)(3)(4) Application for a certificate

*ED Decision 2014/012/R*

### METEOROLOGICAL CONDITIONS

The applicant should provide the Competent Authority with a meteorological study of the area of the aerodrome, including temperature, visibility, ceiling and wind conditions; moreover, the study should provide information on wind conditions occurring with poor visibility and/or low cloud base at the aerodrome, and their frequency, as well as the accompanying wind direction and speed.

## AMC1 ADR.OR.B.015(b)(4) Application for a certificate

*ED Decision 2014/012/R*

### EVIDENCE OF ARRANGEMENTS WITH THIRD PARTIES

The applicant should provide all necessary evidence for arrangements with third parties that provide, or intend to provide services, or undertake activities at the aerodrome, whose activities may have an impact on safety.

## AMC1 ADR.OR.B.015(b)(5) Application for a certificate

*ED Decision 2014/012/R*

### ADEQUACY OF RESOURCES

- (a) General

The applicant should provide all necessary information needed in order to demonstrate to the Competent Authority that its proposed organisation and management are suitable, and properly matched to the scale and scope of the operation.

The aerodrome operator should have the ability to discharge its responsibilities with regard to safety. The accountable manager should have access, as well as the authorisation, to the necessary resources to ensure that operations are carried out in accordance with the applicable requirements. The resources include, but are not limited to, personnel, tools and equipment, as well as financial resources.

(b) Arrangements with other parties

The applicant should indicate those services that are going to be provided directly by the applicant itself and those that will be provided by contracted third parties with regard to the adequacy of the resources.

The applicant should also provide evidence of arrangements if third parties are going to be involved in the provision of services. In addition, the applicant should provide any relevant information needed, or requested by the Competent Authority, regarding such third parties.

## **GM1 ADR.OR.B.015(b)(5) Application for a certificate**

*ED Decision 2014/012/R*

### **ADEQUACY OF RESOURCES**

(a) General

In demonstrating to the Competent Authority the suitability of its organisation and management, the applicant should, amongst others, take into account in its analysis the following:

- (1) the size and complexity of the aerodrome;
- (2) the type of traffic;
- (3) the type of operations;
- (4) the level and the density of the traffic;
- (5) the operating hours of the aerodrome;
- (6) the amount of full-time equivalents (FTEs) necessary for each activity;
- (7) human factors principles;
- (8) labour legislation; and
- (9) the degree of subcontracting.

(b) Adequacy of financial resources

The financial resources required are linked to the overall objective for the safe operation and maintenance of the aerodrome, including the aerodrome operator's capability to implement the corrective actions needed, in a timely manner. Information that may be provided to the Competent Authority includes audited accounts of the previous financial year, business plans etc.

## AMC1 ADR.OR.B.015(b)(6) Application for a certificate

*ED Decision 2014/012/R*

### RELATIONSHIP OF THE APPLICANT WITH THE AERODROME OWNER

The applicant should demonstrate to the Competent Authority, in accordance with the applicable national legislation that he/she is duly authorised to undertake all activities necessary under the provisions of the Basic Regulation, and its Implementing Rules, and any other applicable national or European Union rule.

The applicant should also provide the Competent Authority with all information necessary, under the applicable national legislation, to demonstrate to the Competent Authority its relationship with the aerodrome owner, and/or the owner of the land to be used for the aerodrome development.

Such documentation should include, but is not limited to, contracts, lease agreements, authorisations between the persons involved, etc.

## AMC1 ADR.OR.B.015(b)(7) Application for a certificate

*ED Decision 2014/012/R*

### INFORMATION TO BE PROVIDED FOR MANAGEMENT PERSONNEL

The applicant should provide information regarding the qualifications, and experience of the accountable manager, and the other nominated persons required.

## AMC1 ADR.OR.B.015(b)(9) Application for a certificate

*ED Decision 2014/012/R*

### AERODROME MANUAL

The aerodrome manual and its amendments may be submitted to the Competent Authority in electronic format if this is acceptable to the Competent Authority. If the aerodrome manual is submitted in electronic format, the format should be such that allows the Competent Authority to review, store, and reproduce it.

## ADR.OR.B.025 Demonstration of compliance

*Regulation (EU) No 139/2014*

- (a) The aerodrome operator shall:
- (1) perform and document all actions, inspections, tests, safety assessments or exercises necessary, and shall demonstrate to the Competent Authority:
    - (i) compliance with the notified certification basis, the certification specifications applicable to a change, any safety directive, as appropriate, and the applicable requirements of Regulation (EC) No 216/2008 and its Implementing Rules;
    - (ii) that the aerodrome, as well as its obstacle limitation and protection surfaces and other areas associated with the aerodrome, have no features or characteristics making it unsafe for operation; and
    - (iii) that the flight procedures of the aerodrome have been approved.

[applicable until 26 January 2022]

- (iii) that the flight procedures of the aerodrome and the associated changes thereto, have been established in accordance with Commission Implementing Regulation (EU) 2017/373<sup>1</sup>.

[applicable from 27 January 2022 — Implementing Regulation (EU) 2020/469]

- (2) provide to the Competent Authority the means by which compliance has been demonstrated; and
- (3) declare to the Competent Authority its compliance with point (a)(1).
- (b) Relevant design information, including drawings, inspection, test and other relevant reports, shall be held and kept by the aerodrome operator at the disposal of the Competent Authority, in accordance with the provisions of [ADR.OR.D.035](#) and provided on request to the Competent Authority.

## AMC1 ADR.OR.B.025(a)(1) Demonstration of compliance

ED Decision 2014/012/R

### USE OF THIRD PARTIES TO DEMONSTRATE COMPLIANCE

While performing the necessary actions, inspections, tests, safety assessments, or exercises necessary to demonstrate compliance, the aerodrome operator may also use contracted third parties.

In any case, the responsibility remains with the aerodrome operator.

## AMC2 ADR.OR.B.025(a)(1) Demonstration of compliance

ED Decision 2014/012/R

### FLIGHT PROCEDURES

Evidence that the flight procedures of the aerodrome have been approved, as required by the applicable requirements, is considered to be an Acceptable Means of Compliance.

<sup>1</sup> Commission Implementing Regulation (EU) 2017/373 of 1 March 2017 laying down common requirements for providers of air traffic management/air navigation services and other air traffic management network functions and their oversight, repealing Regulation (EC) No 482/2008, Implementing Regulations (EU) No 1034/2011, (EU) No 1035/2011 and (EU) 2016/1377 and amending Regulation (EU) No 677/2011 ([OJ L 62, 8.3.2017, p. 1](#)).



## GM1 ADR.OR.B.025(a)(3) Demonstration of compliance

*ED Decision 2014/012/R*

### MODEL FORM OF DECLARATION OF COMPLIANCE — AERODROME OPERATORS

<p><b>Declaration of compliance of aerodrome operator</b></p> <p>in accordance with Commission Regulation (EC) No ...../..... on aerodrome design and operation</p>
<b>Aerodrome name — Location indicator:</b>
<p><b>Aerodrome operator</b></p> <p>Name:</p> <p>Place in which the operator is established or residing:</p> <p>Name and contact details of the accountable manager:</p>
<b>Statements</b>
The certification basis is complied with, and the aerodrome, as well as its obstacle limitation and protection surfaces, and other areas associated with the aerodrome, have no features or characteristics making it unsafe for operation.
All personnel are qualified, competent, and trained in accordance with the applicable requirements.
The management system documentation, including the aerodrome manual, comply with the applicable requirements set out in <a href="#">Part-ADR.OR</a> and <a href="#">Part-ADR.OPS</a> .
The operation and maintenance of the aerodrome will be carried out in accordance with the requirements of Regulation (EC) No 216/2008 and its Implementing Rules, the terms of the certificate, and the procedures and instructions specified in the aerodrome manual.
The aerodrome operator confirms that the information disclosed in this declaration is correct.
<b>Date, name and signature of the accountable manager</b>

## ADR.OR.B.030 Terms of the certificate and privileges of the certificate holder

*Regulation (EU) No 139/2014*

An aerodrome operator shall comply with the scope and privileges defined in the terms of the certificate attached to it.

## ADR.OR.B.035 Continued validity of a certificate

Regulation (EU) No 139/2014

- (a) A certificate shall remain valid subject to:
- (1) the aerodrome operator remaining in compliance with the relevant requirements of Regulation (EC) No 216/2008, and its Implementing Rules, and the aerodrome remaining in compliance with the certification basis, taking into account the provisions related to the handling of findings as specified under [ADR.OR.C.020](#);
  - (2) the Competent Authority being granted access to the aerodrome operator's organisation as defined in [ADR.OR.C.015](#) to determine continued compliance with the relevant requirements of Regulation (EC) No 216/2008 and its Implementing Rules; and
  - (3) the certificate not being surrendered or revoked.
- (b) Upon revocation or surrender, the certificate shall be returned to the Competent Authority without delay.

## ADR.OR.B.037 Continued validity of a declaration of a provider of apron management services

Regulation (EU) No 139/2014

A declaration made by a provider of apron management services in accordance with [ADR.OR.B.060](#) shall remain valid subject to:

- (a) the provider of apron management services and the related facilities remaining in compliance with the relevant requirements of Regulation (EC) No 216/2008 and its Implementing Rules, taking into account the provisions related to the handling of findings as specified under [ADR.OR.C.020](#);
- (b) the Competent Authority being granted access to the apron management services provider's organisation as defined in [ADR.OR.C.015](#) to determine continued compliance with the relevant requirements of Regulation (EC) No 216/2008 and its Implementing Rules; and
- (c) the declaration not being withdrawn by the provider of such services or deregistered by the Competent Authority.

[ADR.OR.B.037 applicable until 19 March 2022 — Delegated Regulation (EU) 2020/1234]

## ADR.OR.B.040 Changes

Regulation (EU) No 139/2014

- (a) Any change:
- (1) affecting the terms of the certificate, its certification basis and safety-critical aerodrome equipment; or
  - (2) significantly affecting elements of the aerodrome operator's management system as required in [ADR.OR.D.005\(b\)](#)
- shall require prior approval by the Competent Authority.

- (b) For other changes requiring prior approval in accordance with Regulation (EC) No 216/2008 and its Implementing Rules, the aerodrome operator shall apply for and obtain an approval issued by the Competent Authority.
- (c) The application for a change in accordance with point (a) or (b) shall be submitted before any such change takes place, in order to enable the Competent Authority to determine continued compliance with Regulation (EC) No 216/2008 and its Implementing Rules and to amend, if necessary, the certificate and related terms of the certificate attached to it.

The change shall only be implemented upon receipt of formal approval by the Competent Authority in accordance with [ADR.AR.C.040](#).

During the changes, the aerodrome operator shall operate under the conditions approved by the Competent Authority.

- (d) Changes not requiring prior approval shall be managed and notified to the Competent Authority as defined in the procedure approved by the Competent Authority in accordance with [ADR.AR.C.035\(h\)](#).
- (e) The aerodrome operator shall provide the Competent Authority with the relevant documentation in accordance with point (f) and [ADR.OR.E.005](#).
- (f) As part of its management system, as defined in [ADR.OR.D.005](#), the aerodrome operator proposing a change to the aerodrome, its operation, its organisation or its management system shall:
- (1) determine the interdependencies with any affected parties, plan and conduct a safety assessment in coordination with these organisations;
  - (2) align assumptions and mitigations with any affected parties, in a systematic way;
  - (3) ensure a comprehensive assessment of the change including any necessary interactions; and
  - (4) ensure that complete and valid arguments, evidence and safety criteria are established and documented to support the safety assessment, and that the change supports the improvement of safety whenever reasonably practicable.

## AMC1 ADR.OR.B.040(a);(b) Changes

ED Decision 2014/012/R

### CHANGES REQUIRING PRIOR APPROVAL

The aerodrome operator should ensure that prior to initiating any change to the aerodrome or its operation, which requires prior approval, an application is submitted to the Competent Authority. The applicant should provide documentation containing a description of the proposed change, in which the following are identified:

- (a) the terms of the certificate, and/or the elements of the certification basis, and/or the safety-critical aerodrome equipment and/or aerodrome operator's management system (as required by [ADR.OR.D.005\(b\)](#)), and the parts of aerodrome manual, which are affected by the change, including relevant appropriate detailed design drawings;

- (b) the certification specifications with which the proposed change has been designed to comply with, including the certification specifications for which the applicant proposes to show compliance in a different manner in order to demonstrate an equivalent level of safety (for such cases see [AMC1 ADR.OR.B.015\(b\)\(1\);\(2\);\(3\);\(4\)](#), paragraph (c)(1));
- (c) the requirements of [Part-ADR.OR](#) and [Part-ADR.OPS](#), and any other applicable requirements that have to be complied with as a result of the proposed change, including the way in which compliance is intended to be demonstrated; and
- (d) the safety assessment required under [ADR.OR.B.040\(f\)](#).

## GM1 ADR.OR.B.040(a);(b) Changes

ED Decision 2014/012/R

### CHANGES REQUIRING PRIOR APPROVAL

The following is a list of items which are granted prior approval by the Competent Authority, as specified in the applicable Implementing Rules.

- (a) Use of alternative means of compliance as required by [ADR.OR.A.015](#) Means of Compliance.
- (b) Changes to the management and notification procedure for changes not requiring a prior approval, as required by [ADR.OR.B.015\(b\)\(4\)](#) Application for a certificate.
- (c) Changes to the certification basis, or the terms of the certificate, as required by [ADR.OR.B.040\(a\)\(1\)](#) Changes.
- (d) Changes to safety-critical aerodrome equipment as required by [ADR.OR.B.040\(a\)\(1\)](#) Changes.
- (e) Changes significantly affecting elements of the aerodrome operator's management system as required by [ADR.OR.B.040\(a\)\(2\)](#) Changes.
- (f) Changes to the level of protection of rescue and firefighting services as required by [ADR.OPS.B.010\(a\)\(1\)\(2\)](#) Rescue and firefighting services.
- (g) Implementation of aeroplane operations on specially prepared winter runways as required by [ADR.OPS.B.036](#) Operations on specially prepared winter runways.

*[applicable from 12 August 2021 — ED Decision 2021/003/R]*

- (h) Changes to low-visibility procedures as required by [ADR.OPS.B.045\(b\)](#) Low Visibility Operations.
- (i) Operation of aircraft with higher code letter as required by [ADR.OPS.B.090\(a\)](#) Use of the aerodrome by higher code letter aircraft.
- (j) Changes to the flight procedures.

Moreover the Competent Authority may require prior approval for changes to any obstacles, developments and other activities within the areas monitored by the aerodrome operator in accordance with [ADR.OPS.B.075](#), which may endanger safety and adversely affect the operation of an aerodrome, as required by [ADR.AR.C.005\(e\)](#).

## GM1 ADR.OR.B.040(f) Changes

*ED Decision 2014/012/R*

### ASSESSMENT OF CHANGES

(a) Safety assessment for a change

A safety assessment for a change should include:

- (1) identification of the scope of the change;
- (2) identification of hazards;
- (3) determination of the safety criteria applicable to the change;
- (4) risk analysis in relation to the harmful effects or improvements in safety related to the change;
- (5) risk evaluation and, if required, risk mitigation for the change to meet the applicable safety criteria;
- (6) verification that the change conforms to the scope that was subject to safety assessment, and meets the safety criteria, before the change is put into operation; and
- (7) the specification of the monitoring requirements necessary to ensure that the aerodrome and its operation will continue to meet the safety criteria after the change has taken place.

(b) Scope of the safety assessment

The scope of the safety assessment should include the following elements and their interaction:

- (1) the aerodrome, its operation, management, and human elements being changed;
- (2) interfaces and interactions between the elements being changed and the remainder of the system;
- (3) interfaces and interactions between the elements being changed and the environment in which it is intended to operate; and
- (4) the full lifecycle of the change from definition to operations.

(c) Safety criteria

The safety criteria used should be defined in accordance with the procedures for the management of change contained in the aerodrome manual.

The safety criteria used should, depending on the availability of data, be specified with reference to explicit quantitative acceptable safety risk levels, recognised standards, and/or codes of practice, the safety performance of the existing system, or a similar system.

## GM2 ADR.OR.B.040(f) Changes

ED Decision 2014/012/R

### ASSESSMENT OF CHANGES - LOCAL RUNWAY SAFETY TEAM

For the role of the Local Runway Safety Team prior to implementing changes, see also [GM2 ADR.OR.D.027](#).

## GM3 ADR.OR.B.040(f) Changes

ED Decision 2014/012/R

### ASSESSMENT OF CHANGES – RUNWAY SAFETY

Particular attention should be given to changes which may have an effect on runway safety. This includes the introduction of, or changes to noise mitigation or noise abatement procedures.

## ADR.OR.B.050 Continuing compliance with the Agency's certification specifications

Regulation (EU) No 139/2014

The aerodrome operator, following an amendment of the certification specifications established by the Agency, shall:

- (a) perform a review to identify any certification specifications which are applicable to the aerodrome; and
- (b) if relevant, initiate a change process in accordance with [ADR.OR.B.040](#) and implement the necessary changes at the aerodrome.

## ADR.OR.B.060 Declaration of providers of apron management services

Regulation (EU) No 139/2014

- (a) Providers of apron management services that have been allowed to declare their capability and means of discharging the responsibilities associated with the provision of such services, and following an agreement with an aerodrome operator for the provision of such services at an aerodrome, shall:
  - (1) provide the Competent Authority with all relevant information and declare its compliance with all applicable requirements of Regulation (EC) No 216/2008 and its Implementing Rules, using a form established by the Competent Authority;
  - (2) provide the Competent Authority with a list of the alternative means of compliance used, in accordance with [ADR.OR.A.015\(b\)](#);
  - (3) maintain compliance with the applicable requirements and with the information given in the declaration;
  - (4) notify the Competent Authority of any changes to its declaration or the means of compliance it uses through submission of an amended declaration; and

- (5) provide its services in accordance with the aerodrome manual and comply with all relevant provisions contained therein.
- (b) Before ceasing the provision of such services, the provider of apron management services shall notify the Competent Authority and the aerodrome operator.

*[ADR.OR.B.060 applicable until 19 March 2022 — Delegated Regulation (EU) 2020/1234]*

## GM1 ADR.OR.B.060 Declaration of providers of apron management services

*ED Decision 2014/012/R*

### MODEL FORM OF DECLARATION OF COMPLIANCE — PROVIDERS OF APRON MANAGEMENT SERVICES

<b>Declaration of compliance of provider of Apron Management Services</b>	
In accordance with Commission Regulation (EC) No XXX/2013 laying down requirements and procedures related to aerodromes pursuant to Regulation (EC) No 216/ 2008 of the European Parliament and of the Council	
Provider of apron management services  Company name and address:  Name and contact details of the accountable manager:	
Starting date of operation:	
Aerodrome(s) at which the apron management services are provided:	
Applicable requirements set out in <a href="#">Part-ADR.OPS</a> on the provision of apron management services are documented and reflected in the aerodrome manual.	
Attached to this declaration is a list of alternative means of compliance with references to the AMCs they replace, in accordance with <a href="#">ADR.OR.A.015(c)</a> .	
The services are provided in accordance with the content of the relevant aerodrome manual.	
Personnel of the apron management services provider have received the necessary initial training, and receive recurrent training to ensure continuing competence.	
(If applicable) The operator has implemented and demonstrated conformance to an officially recognised industry standard.  Reference of the standard: _____ Certification body: _____  Date of the last conformance audit: _____	
Any change in the operation that affects the information disclosed in this declaration will be notified to the Competent Authority.	
I hereby confirm that the information disclosed in this declaration is correct.	
Date and signature of the accountable manager	

[GM1 ADR.OR.B.060 applicable until 19 March 2022 — ED Decision 2020/021/R]

## ADR.OR.B.065 Termination of operation

Regulation (EU) No 139/2014

An operator intending to terminate the operation of an aerodrome shall:

- (a) notify the Competent Authority as soon as possible;
- (b) provide such information to the appropriate Aeronautical Information Service provider;
- (c) surrender the certificate to the Competent Authority upon the date of termination of operation;  
and
- (d) ensure that appropriate measures have been taken to avoid the unintended use of the aerodrome by aircraft, unless the Competent Authority has approved the use of the aerodrome for other purposes.

## AMC1 ADR.OR.B.065 Termination of operation

ED Decision 2014/012/R

### TERMINATION OF OPERATION

In case of intended termination of the operation of the aerodrome, the aerodrome operator should notify, in writing, the Competent Authority and the Aeronautical Information Service provider. The notification should be done in such time in advance, so as to allow for the timely publication of the changes, and their notification by the Aeronautical Information Regulation And Control (AIRAC) system in accordance with the related timeframe.

Upon the termination of the operation, the aerodrome operator should apply closed runway markings, as well as any other measure the Competent Authority has found appropriate.

## ADR.OR.B.070 Termination of the provision of apron management service

Delegated Regulation (EU) 2020/1234

The aerodrome operator shall:

- (a) take appropriate measures to ensure that safety risks that result from the termination of operation have been assessed and mitigated;
- (b) provide information on the measures referred to in point (a) to the appropriate aeronautical information service provider.

[applicable from 20 March 2022]



## **SUBPART C — ADDITIONAL AERODROME OPERATOR RESPONSIBILITIES (ADR.OR.C)**

### **ADR.OR.C.005 Aerodrome operator responsibilities**

*Regulation (EU) No 139/2014*

- (a) The aerodrome operator is responsible for the safe operation and maintenance of the aerodrome in accordance with:
  - (1) Regulation (EC) No 216/2008 and its Implementing Rules;
  - (2) the terms of its certificate;
  - (3) the content of the aerodrome manual; and
  - (4) any other manuals for the aerodrome equipment available at the aerodrome, as applicable.
- (b) The aerodrome operator shall ensure directly, or coordinate through arrangements as required with the accountable entities providing the following services:
  - (1) the provision of air navigation services appropriate to the level of traffic and the operating conditions at the aerodrome; and
  - (2) the design and maintenance of the flight procedures, in accordance with the applicable requirements.
- (c) The aerodrome operator shall coordinate with the Competent Authority to ensure that relevant information for the safety of aircraft is contained in the aerodrome manual and is published where appropriate. This shall include:
  - (1) exemptions or derogations granted from the applicable requirements;
  - (2) provisions for which an equivalent level of safety was accepted by the Competent Authority as part of the certification basis; and
  - (3) special conditions and limitations with regard to the use of the aerodrome.
- (d) If an unsafe condition develops at the aerodrome, the aerodrome operator shall, without undue delay, take all necessary measures to ensure that those parts of the aerodrome found to endanger safety are not used by aircraft.

### **AMC1 ADR.OR.C.005(c) Aerodrome operator responsibilities**

*ED Decision 2014/012/R*

#### **PUBLICATION OF INFORMATION TO THE AERONAUTICAL INFORMATION PUBLICATION**

A description of cases involving exemptions, derogations, cases of equivalent level of safety, special conditions, including limitations with regard to the use of the aerodrome, should be published in the Aeronautical Information Publication (AIP), after coordination with the Competent Authority.

## ADR.OR.C.015 Access

Regulation (EU) No 139/2014

For the purpose of determining compliance with the relevant requirements of Regulation (EC) No 216/2008 and its Implementing Rules, an aerodrome operator or provider of apron management services shall grant access to any person authorised by the Competent Authority, to:

*[applicable until 19 March 2022]*

For the purpose of determining compliance with the relevant requirements in [Regulation \(EU\) 2018/1139](#) and the delegated and implementing acts adopted on the basis thereof, an aerodrome operator shall grant access to any person authorised by the Competent Authority to:

*[applicable from 20 March 2022 — Delegated Regulation (EU) 2020/1234]*

- (a) any facility, document, records, data, procedures or any other material relevant to its activity subject to certification or declaration, whether it is contracted or not; and
- (b) perform or witness any action, inspection, test, assessment or exercise the Competent Authority finds is necessary.

## ADR.OR.C.020 Findings and corrective actions

Regulation (EU) No 139/2014

After receipt of notification of findings, the aerodrome operator or the provider of apron management services shall:

*[applicable until 19 March 2022]*

After receipt of a notification of findings, the aerodrome operator shall:

*[applicable from 20 March 2022 — Delegated Regulation (EU) 2020/1234]*

- (a) identify the root cause of the non-compliance;
- (b) define a corrective action plan; and
- (c) demonstrate the corrective action implementation to the satisfaction of the Competent Authority within the period agreed with that authority as defined in [ADR.AR.C.055\(d\)](#).

## AMC1 ADR.OR.C.020(b) Findings

ED Decision 2014/012/R

### GENERAL

The corrective action plan defined by the aerodrome operator should address the effects of the non-compliance, as well as its root cause.

## GM1 ADR.OR.C.020 Findings

ED Decision 2014/012/R

### GENERAL

- (a) Preventive action is the action to eliminate the cause of a potential non-compliance or other undesirable potential situation.
- (b) Corrective action is the action to eliminate or mitigate the root cause(s), and prevent recurrence of an existing detected non-compliance, or other undesirable condition or situation. Proper

determination of the root cause is crucial for defining effective corrective actions to prevent recurrence.

- (c) Correction is the action to eliminate a detected non-compliance.

## ADR.OR.C.025 Immediate reaction to a safety problem — compliance with safety directives

Regulation (EU) No 139/2014

The aerodrome operator or provider of apron management services shall implement any safety measures, including safety directives, mandated by the Competent Authority in accordance with [ADR.AR.A.030\(c\)](#) and [ADR.AR.A.040](#).

*[applicable until 19 March 2022]*

The aerodrome operator shall implement any safety measures, including safety directives, taken by the Competent Authority in accordance with points [ADR.AR.A.030\(c\)](#) and [ADR.AR.A.040](#) of Annex II.

*[applicable from 20 March 2022 — Delegated Regulation (EU) 2020/1234]*

## ADR.OR.C.030 Occurrence reporting

Regulation (EU) No 139/2014

- (a) The aerodrome operator and the provider of apron management services shall report to the Competent Authority, and to any other organisation required by the State where the aerodrome is located, any accident, serious incident and occurrence as defined in [Regulation \(EU\) No 996/2010](#) of the European Parliament and the Council<sup>1</sup> and Directive 2003/42/EC<sup>2</sup>.

*[applicable until 19 March 2022]*

- (a) The aerodrome operator shall report to the Competent Authority and to any other organisation required by the State where the aerodrome is located, any accident, serious incident and occurrence as defined in [Regulation \(EU\) No 996/2010](#) of the European Parliament and the Council<sup>3</sup> and [Regulation \(EU\) No 376/2014](#).

*[applicable from 20 March 2022 — Delegated Regulation (EU) 2020/1234]*

- (b) Without prejudice to point (a) the operator shall report to the Competent Authority and to the organisation responsible for the design of aerodrome equipment any malfunction, technical defect, exceeding of technical limitations, occurrence or other irregular circumstance that has or may have endangered safety and that has not resulted in an accident or serious incident.
- (c) Without prejudice to [Regulation \(EU\) No 996/2010](#) and Directive 2003/42/EC, Commission Regulation (EC) No 1321/2007<sup>4</sup> and Commission Regulation (EC) No 1330/2007<sup>5</sup> the reports referred to in points (a) and (b) shall be made in a form and manner established by the

<sup>1</sup> OJ L 295, 12.11.2010, p. 35.

<sup>2</sup> OJ L 167, 4.7.2003, p. 23.

<sup>3</sup> Regulation (EU) No 996/2010 of the European Parliament and the Council of 20 October 2010 on the investigation and prevention of accidents and incidents in civil aviation and repealing Directive 94/56/EC ([OJ L 295, 12.11.2010, p. 35](#)).

<sup>4</sup> OJ L 294, 13.11.2007, p. 3.

<sup>5</sup> OJ L 295, 14.11.2007, p. 7.

Competent Authority and contain all pertinent information about the condition known to the aerodrome operator or the provider of apron management services.

- (d) Reports shall be made as soon as practicable, but in any case within 72 hours of the aerodrome operator or the provider of the apron management services identifying the condition to which the report relates, unless exceptional circumstances prevent this.

*[applicable until 19 March 2022]*

- (d) Reports shall be made by the aerodrome operator within 72 hours of becoming aware of the occurrence to which the report relates, unless exceptional circumstances prevent this.

*[applicable from 20 March 2022 — Delegated Regulation (EU) 2020/1234]*

- (e) Where relevant, the aerodrome operator or the provider of apron management services shall produce a follow-up report to provide details of actions it intends to take to prevent similar occurrences in the future, as soon as these actions have been identified. This report shall be produced in a form and manner established by the Competent Authority.

*[applicable until 19 March 2022]*

- (e) Where relevant, the aerodrome operator shall produce a follow-up report to provide details of actions it intends to take to prevent similar occurrences in the future, as soon as those actions have been identified. That report shall be produced in a form and manner established by the Member State.

*[applicable from 20 March 2022 — Delegated Regulation (EU) 2020/1234]*

## AMC1 ADR.OR.C.030 Occurrence reporting

*ED Decision 2014/012/R*

### GENERAL

The aerodrome operator and the provider of provider of apron management services should establish procedures to be used for reporting to the Competent Authority and any other organisation required which include:

- (a) description of the applicable requirements for reporting;
- (b) description of the reporting mechanism, including reporting forms, means, and deadlines;
- (c) personnel responsible for reporting; and
- (d) description of mechanism and personnel responsibilities for identifying root causes, and the actions that may be needed to be taken to prevent similar occurrences in the future, as appropriate.

*[applicable until 19 March 2022]*

## AMC1 ADR.OR.C.030 Occurrence reporting

*ED Decision 2020/021/R*

### GENERAL

The aerodrome operator should establish procedures to be used for reporting to the Competent Authority and to any other organisation, as required, which include:

- (a) the description of the applicable requirements for the purpose of reporting;

- (b) the description of the reporting mechanism, including reporting forms, means, and deadlines;
- (c) the personnel responsible for reporting; and
- (d) the description of the mechanism and personnel responsibilities for identifying root causes, and the actions that may be needed to be taken to prevent similar occurrences from happening in the future, as appropriate.

*[applicable from 20 March 2022]*

## ADR.OR.C.040 Prevention of fire

*Regulation (EU) No 139/2014*

The aerodrome operator shall establish procedures to prohibit:

- (a) smoking within the movement area, other operational areas of the aerodrome, or areas of the aerodrome where fuel or other flammable material is stored;
- (b) display of an open flame or undertaking of an activity that would create a fire hazard within:
  - (1) areas of the aerodrome where fuel or other flammable material is stored;
  - (2) the movement area or other operational areas of the aerodrome, unless authorised by the aerodrome operator.

## AMC1 ADR.OR.C.040 Prevention of fire

*ED Decision 2014/012/R*

The aerodrome operator should develop procedures and assign responsibilities for the control of smoking or activities that involve the use of fire hazard, as appropriate.

In addition, these procedures should address the adoption and use of mitigating measures when necessary activities (e.g. maintenance, etc.) which might involve fire hazard need to be authorised.

Such authorised activities may not include smoking within the movement area, other operational areas of the aerodrome, or areas of the aerodrome where fuel or other flammable material are stored.

## ADR.OR.C.045 Use of alcohol, psychoactive substances and medicines

*Regulation (EU) No 139/2014*

- (a) The aerodrome operator shall establish procedures on the level of consumption of alcohol, psychoactive substances and medicines by:
  - (1) personnel involved in the operation, rescue and firefighting, and maintenance of the aerodrome;
  - (2) unescorted persons operating on the movement area or other operational areas of the aerodrome.
- (b) These procedures shall include the requirements that such persons shall:
  - (1) not consume alcohol during their duty period;
  - (2) not perform any duties under the influence:
    - (i) of alcohol, or any psychoactive substance; or

- (ii) any medicine that may have an effect on his/her abilities in a manner contrary to safety.

## GM1 ADR.OR.C.045 Use of alcohol, psychoactive substances and medicines

ED Decision 2014/012/R

- (a) The procedures that the aerodrome operator should establish with respect to the level of consumption of alcohol, psychoactive substances and medicines are applicable to all persons referred to in paragraph (a) of [ADR.OR.C.045](#). This includes the following:
  - (1) personnel involved in the operation, rescue and firefighting, and maintenance of the aerodrome, irrespectively of the relationship they have with the aerodrome operator (e.g. directly employed by the aerodrome operator or by organisations contracted by the aerodrome operator);
  - (2) unescorted persons operating on the movement area or other operational areas of the aerodrome. This category of persons includes:
    - (i) persons employed directly by the aerodrome operator, or by organisations contracted by the aerodrome operator, which are not involved in the operation, rescue and firefighting, and maintenance of the aerodrome (e.g. aerodrome security personnel);
    - (ii) persons employed by other organisations (e.g. ground handling companies).
- (b) Notwithstanding the responsibilities of the organisations referred to in paragraph (a)(2)(ii), the aerodrome operator should ensure that these organisations establish appropriate procedures to comply with the provisions of [ADR.OR.C.045](#) and the related requirements established by the aerodrome operator.

Further guidance on this issue may be found in the ICAO Manual on Prevention of Problematic Use of Substances in the Aviation Workplace (Doc 9654).

## **SUBPART D — MANAGEMENT (ADR.OR.D) [UNTIL 19 MARCH 2022] / SUBPART D — MANAGEMENT — AERODROME OPERATORS (ADR.OR.D) [FROM 20 MARCH 2022 — DELEGATED REGULATION (EU) 2020/1234]**

### **ADR.OR.D.005 Management system**

*Regulation (EU) No 139/2014*

- (a) The aerodrome operator shall implement and maintain a management system integrating a safety management system.
- (b) The management system shall include:
  - (1) clearly defined lines of responsibility and accountability throughout the aerodrome operator, including a direct accountability for safety on the part of senior management;
  - (2) a description of the overall philosophies and principles of the aerodrome operator with regard to safety, referred to as the safety policy, signed by the accountable manager;
  - (3) a formal process that ensures that hazards in operations are identified;
  - (4) a formal process that ensures analysis, assessment and mitigation of the safety risks in aerodrome operations;
  - (5) the means to verify the safety performance of the aerodrome operator's organisation in reference to the safety performance indicators and safety performance targets of the safety management system, and to validate the effectiveness of safety risk controls;
  - (6) a formal process to:
    - (i) identify changes within the aerodrome operator's organisation, management system, the aerodrome or its operation which may affect established processes, procedures and services;
    - (ii) describe the arrangements to ensure safety performance before implementing changes; and
    - (iii) eliminate or modify safety risk controls that are no longer needed or effective due to changes in the operational environment;
  - (7) a formal processes to review the management system referred to in paragraph (a), identify the causes of substandard performance of the safety management system, determine the implications of such substandard performance in operations, and eliminate or mitigate such causes;
  - (8) a safety training programme that ensures that personnel involved in the operation, rescue and firefighting, maintenance and management of the aerodrome are trained and competent to perform the safety management system duties;

- (9) formal means for safety communication that ensures that personnel are fully aware of the safety management system, conveys safety critical information, and explains why particular safety actions are taken and why safety procedures are introduced or changed;
  - (10) coordination of the safety management system with the aerodrome emergency response plan; and coordination of the aerodrome emergency response plan with the emergency response plans of those organisations it must interface with during the provision of aerodrome services; and
  - (11) a formal process to monitor compliance of the organisation with the relevant requirements.
- (c) The aerodrome operator shall document all management system key processes.
  - (d) The management system shall be proportionate to the size of the organisation and its activities, taking into account the hazards and associated risks inherent in these activities.
  - (e) In the case that the aerodrome operator holds also a certificate to provide air navigation services, it shall ensure that the management system covers all activities in the scope of its certificates.

## AMC1 ADR.OR.D.005(b)(1) Management system

ED Decision 2014/012/R

### SAFETY MANAGEMENT SYSTEM

The safety management system of an aerodrome operator should encompass safety by establishing an organisational structure for the management of safety proportionate and appropriate to the size of the aerodrome operator, and the nature and type of operations. The organisational structure should include a Safety Review Board, and depending on its organisational complexity and structure, a Safety Services Office to assist the work of the safety manager, in accordance with paragraph (a) and (b) below:

- (a) Safety Services Office
  - (1) The safety manager (see [ADR.OR.D.015](#) and [AMC1 ADR.OR.D.015\(c\)](#)) should be responsible for the operation of the Safety Services Office which should be independent and neutral in terms of the processes and decisions made regarding the delivery of services by the line managers of operational units.
  - (2) The function of the Safety Services Office should be to:
    - (i) manage and oversee the hazard identification system;
    - (ii) monitor safety performance of operational units directly involved in aerodrome operations;
    - (iii) advise senior management on safety management matters; and
    - (iv) assist line managers with safety management matters.
  - (3) Operators of multiple aerodromes should either establish a central Safety Services Office and appropriate safety departments/functions at all aerodromes or separate Safety



Services Office at each aerodrome. Arrangements should be made to ensure continuous flow of information and adequate coordination.

(b) Safety Review Board

- (1) The Safety Review Board should be a high level committee that considers matters of strategic safety in support of the accountable manager's safety accountability.
- (2) The Safety Review Board should be chaired by the accountable manager, and be composed of heads of functional areas.
- (3) The Safety Review Board should monitor:
  - (i) safety performance against the safety policy and objectives;
  - (ii) that any safety action is taken in a timely manner; and
  - (iii) the effectiveness of the organisation's safety management processes.
- (4) The Safety Review Board should ensure that appropriate resources are allocated to achieve the established safety performance.
- (5) The safety manager or any other relevant person may attend, as appropriate, Safety Review Board meetings. He/she may communicate to the accountable manager all information, as necessary, to allow decision making based on safety data.
- (6) Operators of multiple aerodromes should either establish a central Safety Review Board, or separate Safety Review Boards for each aerodrome or group of aerodromes. In the case of central or group Safety Review Groups, they should ensure that all aerodromes are represented in the Safety Review Board, at the appropriate management level. Arrangements should be made to ensure continuous flow of information and adequate coordination.

In less complex aerodrome organisations/operations, the aerodrome operator should nominate a person who fulfils the role of safety manager, and who is responsible for coordinating the safety management system (see [ADR.OR.D.015](#) and [AMC1 ADR.OR.D.015\(c\)](#)).

## GM1 ADR.OR.D.005(b)(1) Management system

ED Decision 2014/012/R

### SAFETY REVIEW BOARD — SAFETY ACTION GROUP

(a) Safety Review Board

Depending on the size of the organisation, the type and complexity of operations, the responsibilities of the Safety Review Board may be included in other high level committees of the organisation.

(b) Safety Action Group

- (1) A Safety Action Group may be established as a standing group, or as an ad hoc group to assist or act on behalf of the Safety Review Board.
- (2) More than one safety action group may be established depending on the scope of the task and specific expertise required.

- (3) A Safety Action Group should report to, and take strategic direction from the Safety Review Board, and should be comprised of managers, supervisors, and personnel from operational areas.
- (4) The Safety Action Group should:
  - (i) monitor operational safety;
  - (ii) resolve identified risks;
  - (iii) assess the impact on safety of operational services;
  - (iv) ensure that safety actions are implemented within agreed timescales.
- (5) The Safety Action Group should review the effectiveness of previous safety recommendations and safety promotion.

## GM2 ADR.OR.D.005(b)(1) Management system

*ED Decision 2014/012/R*

### **SAFETY SERVICES OFFICE — SAFETY REVIEW BOARD — SAFETY ACTION GROUP**

Different titles may also be used for the Safety Services Office, the Safety Review Board, and the Safety Actions Group.

## AMC1 ADR.OR.D.005(b)(2) Management system

*ED Decision 2014/012/R*

### **SAFETY POLICY**

- (a) The safety policy should:
  - (1) be endorsed by the accountable manager;
  - (2) clearly identify safety as the highest organisational priority over commercial, operational, environmental, or social pressures;
  - (3) reflect organisational commitments regarding safety and its proactive and systematic management;
  - (4) be communicated, with visible endorsement, throughout the organisation;
  - (5) include safety reporting principles; and
  - (6) be periodically reviewed to ensure it remains relevant and appropriate to the organisation.
- (b) The safety policy should:
  - (1) include a commitment:
    - (i) to improve towards the highest safety standards;
    - (ii) to comply with all applicable legal requirements, meet all applicable standards, and consider best practices;
    - (iii) to provide appropriate resources;

- (iv) to enforce safety as one primary responsibility of all managers and staff;
  - (2) include the safety reporting procedures;
  - (3) with reference to a just culture, clearly indicate which types of operational behaviours are unacceptable, and include the conditions under which disciplinary action would not apply; and
  - (4) be periodically reviewed to ensure it remains relevant and appropriate.
- (c) Senior management should:
- (1) continually promote the safety policy to all personnel, and demonstrate their commitment to it;
  - (2) provide necessary human and financial resources for its implementation; and
  - (3) establish safety objectives and performance standards.

## **GM1 ADR.OR.D.005(b)(2) Management system**

*ED Decision 2014/012/R*

### **SAFETY POLICY**

(a) Safety policy — General

The safety policy is the means whereby the aerodrome operator states its intention to maintain and, where practicable, improve safety levels in all its activities, and to minimise its contribution to the risk of an aircraft accident as far as reasonably practicable.

The safety policy should state that the purpose of safety reporting, and internal investigations is to improve safety, not to apportion blame to individuals.

(b) Safety policy — Just culture

The safety policy should actively encourage effective safety reporting and, by defining the line between acceptable performance (often unintended errors) and unacceptable performance (such as negligence, recklessness, violations, or sabotage), provide fair protection to reporters. A safety or just culture may not, however, preclude the ‘criminalisation of error’, which is legally, ethically, and morally within the sovereign rights of any Member State, provided European Union law and established international agreements are observed. A judicial investigation, and consequences of some form, may be expected following an accident or serious incident especially if a failure resulted in lives lost or property damaged, even if no negligence or ill intent existed. A potential issue could, therefore, exist if voluntary hazard reports, which relate to latent deficiencies of a system or its performance, are treated in the same way as those concerning accident, and serious incident investigations. The intent of protecting hazard reports should not challenge the legitimacy of a judicial investigation, or demand undue immunity. However, legal argument does usually take precedence over any technical or safety-related argument.

## AMC1 ADR.OR.D.005(b)(3) Management system

ED Decision 2014/012/R

### HAZARD IDENTIFICATION PROCESS

- (a) Hazard identification should be based on a combination of reactive, proactive, and predictive methods of safety data collection. Reactive, proactive, and predictive schemes for hazard identification should be the formal means of collecting, recording, analysing, acting on, and generating feedback about hazards and the associated risks that affect safety.
- (b) All reporting systems, including confidential reporting schemes, should include an effective feedback process.

## GM1 ADR.OR.D.005(b)(3) Management system

ED Decision 2014/012/R

### HAZARD IDENTIFICATION

- (a) Hazard identification — General
  - (1) Hazard identification may include the following factors and processes:
    - (i) design factors, including equipment and task design;
    - (ii) procedures and operating practices, including their documentation and checklists, and their validation under actual operating conditions;
    - (iii) communications, including means, terminology, and language;
    - (iv) personnel factors, such as company policies for recruitment, training, remuneration, and allocation of resources;
    - (v) organisational factors, such as the compatibility of production and safety goals, the allocation of resources, operating pressures, and the corporate safety culture;
    - (vi) work environment factors, such as ambient noise and vibration, temperature, lighting, and the availability of protective equipment and clothing;
    - (vii) regulatory oversight factors, including the applicability and enforceability of regulations, the certification of equipment, personnel, and procedures, and the adequacy of oversight;
    - (viii) defences, including such factors as the provision of adequate detection and warning systems, the error tolerance of equipment, and the resilience of equipment to errors and failures; and
    - (ix) human performance, restricted to medical conditions and physical limitations.
  - (2) Hazard identification may use internal and external sources.
    - (i) Internal sources:
      - (A) voluntary occurrence reporting schemes;
      - (B) safety surveys;
      - (C) safety audits;

- (D) normal operations monitoring schemes;
  - (E) trend analysis;
  - (F) feedback from training; and
  - (G) investigation and follow-up of incidents
- (ii) External sources:
- (A) accident reports;
  - (B) state mandatory occurrence reporting system; and
  - (C) state voluntary reporting system.
- (3) The methods used for hazard identification depends on the resources and constraints of each particular aerodrome operator, and on the size and the complexity of the operations. Nevertheless, hazard identification, regardless of implementation, complexity and size, is part of the aerodrome operator's safety documentation. Under mature safety management practices, hazard identification is a continuous, on-going daily activity. It is an integral part of the aerodrome operator's processes. There are three specific conditions under which special attention to hazard identification should be paid. These three conditions should trigger more in depth and far reaching hazard identification activities and include:
- (i) any time that the aerodrome operator experiences an unexplained increase in safety related events or regulatory infractions;
  - (ii) any time major operational changes are foreseen, including changes to key personnel or other major equipment or systems; and
  - (iii) before and during periods of significant organisational change, including rapid growth or contraction, corporate mergers, acquisitions, or downsizing.
- (4) Hazard identification may use the following tools and techniques:
- (i) brainstorming which is an unbounded but facilitated discussion with a group of experts;
  - (ii) Hazard and Operability (HAZOP) Study which is a systematic and structured approach using parameter and deviation guidewords. This technique relies on a very detailed system description being available for study, and usually involves breaking down the system into well-defined subsystems and functional or process flows between subsystems. Each element of the system is then subject to discussion within a multidisciplinary group of experts, against the various combinations of the guidewords and deviations;
  - (iii) checklists, which are lists of known hazards or hazard causes that have been derived from past experience. The past experience could be previous risk assessments, or similar systems, or operations, or from actual incidents that have occurred in the past. The technique involves the systematic use of an appropriate checklist, and the consideration of each item on the checklist for possible

applicability to a particular system. Checklists should always be validated for applicability prior to use;

- (iv) Failure Modes and Effects Analysis (FMEA), which is a ‘bottom up’ technique, used to consider ways in which the basic components of a system can fail to perform their design intent. The technique relies on a detailed system description, and considers the ways in which each sub-component of the system could fail to meet its design intent, and what the consequences could be for the overall system. For each sub-component of a system the FMEA should consider:

- (A) all the potential ways that the component could fail;
- (B) the effects that each of these failures would have on the system behaviour;
- (C) the possible causes of the various failure modes; and
- (D) how the failures might be mitigated within the system or its environment.

The system level at which the analysis is applied can vary, and is determined by the level of detail of the system description used to support the analysis. Depending on the nature and complexity of the system, the analysis could be undertaken by an individual system expert, or by a team of system experts acting in group sessions.

- (v) the Structured What-If Technique (SWIFT) is a simple and effective alternative technique to HAZOP and involves a multidisciplinary team of experts. It is a facilitated brainstorming group activity, but is typically carried out on a higher level system description, having fewer sub-elements, than for HAZOP and with a reduced set of prompts.
- (5) Identified hazards should be registered in a hazard log (hazard register). The nature and format of such a hazard log may vary from a simple list of hazards to a more sophisticated relational database linking hazards to mitigations, responsibilities, and actions. The following information should be included in the hazard log:
- (i) unique hazard reference number against each hazard;
  - (ii) hazard description;
  - (iii) indication of the potential causes of the hazard;
  - (iv) qualitative assessment of the possible outcomes and severities of consequences arising from the hazard;
  - (v) qualitative assessment of the risk associated with the possible consequences of the hazard;
  - (vi) description of the existing risk controls for the hazard; description of additional actions that are required to reduce safety risks, as well as target date of completion; and
  - (vii) indication of responsibilities in relation to the management of risk controls.
- (6) Additionally, the following information may also be included in the hazard log:

- (i) a quantitative assessment of the risk associated with the possible consequences of the hazard;
  - (ii) record of actual incidents or events related to the hazard, or its causes;
  - (iii) risks tolerability statement;
  - (iv) statement of formal system monitoring requirements;
  - (v) indication of how the hazard was identified;
  - (vi) hazard owner;
  - (vii) assumptions; and
  - (viii) third party stakeholders.
- (b) Hazard identification — Indicators
- (1) Reactive (lagging) indicators:

Metrics that measure events that have already occurred and that impact on safety performance.

As reactive indicators only reflect system failures, their use can only result in determining a reactive response. Although they do measure failure to control hazards, they do not normally reveal why the system failed, or if there are any latent hazards.
  - (2) Proactive (leading) indicators:

Metrics that measure inputs to the safety system (either within an organisation, a sector, or across the total aviation system) to manage and improve safety performance.

Proactive indicators indicate good safety practices being introduced, developed, and adapted which by their inclusion seek to establish a proactive safety environment that engenders continuous improvement. They provide useful information when accident and incident rates are low to identify latent hazards and potential threats, and consequent opportunities for improvement.

There should always be a connection between a proactive indicator and the unwanted outcomes (or reactive indicators) that their monitoring is intended to warn against.
  - (3) Predictive indicators (precursor events):

These metrics can be considered as indicators that do not manifest themselves in accidents or serious incidents. They indicate less severe system failures or ‘near misses’ which when combined with other events may lead to an accident or serious incident.

In a large organisation, a mature safety management system should include all of these measures. Risk management effort, however, should be targeted at leading indicators and precursor events.

## AMC1 ADR.OR.D.005(b)(4) Management system

*ED Decision 2014/012/R*

### SAFETY RISK ASSESSMENT AND MITIGATION

- (a) A formal safety (risk) assessment and mitigation process should be developed and maintained that ensures analysis (in terms of probability and severity of occurrence), assessment (in terms of tolerability), and control (in terms of mitigation) of risks.
- (b) The levels of management who have the authority to make decisions regarding the tolerability of safety risks, in accordance with (a) above, should be specified in the aerodrome manual.

## GM1 ADR.OR.D.005(b)(4) Management system

*ED Decision 2014/012/R*

### SAFETY RISK ASSESSMENT AND MITIGATION

Safety (risk) assessment is the analysis of the safety risks of the consequences of the hazards that have been determined. Safety risk analysis breaks down the risks into two components — the probability of occurrence of a damaging event or condition, and the severity of the event or condition, should it occur. Safety risk decision making and acceptance should be specified through a risk tolerability matrix. The definition and final construction of the matrix should be left to the operator to design, be documented in the aerodrome manual, and be subject to an approval by the Competent Authority.

## AMC1 ADR.OR.D.005(b)(5) Management system

*ED Decision 2014/012/R*

### SAFETY PERFORMANCE MONITORING AND MEASUREMENT

- (a) Safety performance monitoring and measurement should be the process by which the safety performance of the aerodrome operator is verified in comparison to the safety policy and objectives, identified safety risks and the mitigation measures.
- (b) This process should include the setting of safety performance indicators and safety performance targets, and measuring the aerodrome operator's safety performance against them.

## GM1 ADR.OR.D.005(b)(5) Management system

*ED Decision 2014/012/R*

### SAFETY PERFORMANCE MONITORING AND MEASUREMENT

- (a) The performance monitoring and measurement process should include:
  - (1) safety reporting, addressing also the status of compliance with the applicable requirements;
  - (2) safety studies which are rather large analyses encompassing broad safety concerns;
  - (3) safety reviews including trends reviews which are conducted during introduction and deployment of new technologies, change or implementation of procedures, or in situations of structural change in operations, or to explore increase in incidents or safety reports;



- (4) safety audits which focus in the integrity of the aerodrome operator's management system, and periodically assess the status of safety risk controls;
  - (5) safety surveys, which examine particular elements or procedures of a specific operation, such as problem areas or bottlenecks in daily operations, perceptions and opinions of operational personnel, and areas of dissent or confusion; and
  - (6) internal safety investigations whose scope should extend the scope of occurrences required to be reported to the Competent Authority;
- (b) The following generic aspects/areas could be considered:
- (1) accountability for management of the operational activities and its ultimate accomplishment;
  - (2) authority to direct, control, or change the procedures, as well as to make key decisions such as safety risk acceptance decisions;
  - (3) procedures for operational activities;
  - (4) controls, including hardware, software, special procedures or procedural steps, and supervisory practices designed to keep operational activities on track;
  - (5) interfaces, including lines of authority between departments, lines of communication between employees, consistency of procedures, and clear delineation of responsibility between organisations, work units, and employees; and
  - (6) process measures to provide feedback to responsible parties that required actions are taking place, required outputs are being produced, and expected outcomes are being achieved.

## AMC1 ADR.OR.D.005(b)(6) Management system

ED Decision 2014/012/R

### THE MANAGEMENT OF CHANGE

The aerodrome operator should manage safety risks related to a change. The management of change should be a documented process to identify external and internal change that may have an adverse effect on safety.

It should make use of the aerodrome operator's existing hazard identification, safety (risk) assessment, and mitigation processes.

## GM1 ADR.OR.D.005(b)(6) Management system

ED Decision 2014/012/R

### THE MANAGEMENT OF CHANGE

- (a) Change can introduce new hazards, impact the appropriateness and/or effectiveness of existing safety risk mitigation strategies. Changes may be external to the organisation, or internal.
- (b) A formal process for the management of change should take into account the following considerations:

- (1) criticality of systems and activities;
  - (2) stability of systems and operational environments; and
  - (3) past performance.
- (c) System description is one of the fundamental preliminary activities in the planning of the safety management system, to determine a baseline hazard analysis for the baseline system.

As part of the formal process of the management of change, the system description and the baseline hazard analysis should be reviewed periodically, even if circumstances of change are not present, to determine their continued validity.

When changes to the system are made, and periodically thereafter, the aerodrome operator should go over its system and its actual operational environment, in order to make sure it continues to be fully aware of the circumstances under which the provision of services takes place.

With regard to the management of change and safety (risk) assessments related to changes, see also [ADR.OR.B.040](#) and [GM1 ADR.OR.B.040\(f\)](#).

## AMC1 ADR.OR.D.005(b)(7) Management system

ED Decision 2014/012/R

### CONTINUOUS IMPROVEMENT OF THE SAFETY MANAGEMENT SYSTEM

The aerodrome operator should continuously seek to improve its safety performance. The aerodrome operator should develop and maintain a relevant formal process. Continuous improvement should be achieved through:

- (a) proactive and reactive evaluation of facilities, equipment, documentation, and procedures;
- (b) proactive evaluation of an individual's performance, to verify the fulfilment of that individual's safety responsibilities; and
- (c) reactive evaluations in order to verify the effectiveness of the system for control and mitigation of safety risks.

## GM1 ADR.OR.D.005(b)(7) Management system

ED Decision 2014/012/R

### CONTINUOUS IMPROVEMENT OF THE SAFETY MANAGEMENT SYSTEM

Continuous improvement of the safety management system, as part of the safety assurance, is achieved through the application of:

- (a) internal evaluations;
- (b) independent audits (both internal and external);
- (c) strict document controls; and
- (d) continuous monitoring of safety controls and mitigation actions.

## AMC1 ADR.OR.D.005(b)(8) Management system

ED Decision 2014/012/R

### SAFETY MANAGEMENT SYSTEM TRAINING

- (a) The aerodrome operator should establish a safety management system training programme for all aerodrome operations, rescue and firefighting, and maintenance personnel, including all management personnel of the aerodrome (e.g. supervisors, managers, senior managers, and the accountable manager), regardless of their level in the aerodrome operator's organisation.
- (b) The amount and level of detail of safety training should be proportionate and appropriate to the individual's responsibility and involvement in the safety management system.
- (c) The safety management system training programme should be developed in accordance with [AMC1 ADR.OR.D.017\(a\);\(b\)](#), and [AMC1 ADR.OPS.B.010\(b\);\(c\)](#) and be incorporated in the training programme foreseen therein.

## GM1 ADR.OR.D.005(b)(8) Management system

ED Decision 2014/012/R

### STAFF SAFETY MANAGEMENT SYSTEM TRAINING REQUIREMENTS

- (a) Operations, rescue and firefighting, and maintenance personnel
  - (1) Safety training should address safety responsibilities, including adherence to all operating and safety procedures, and recognising and reporting hazards;
  - (2) The training objectives should include the organisation's safety policy and safety management system fundamentals, and overview;
  - (3) The contents should include:
    - (i) definition of hazards;
    - (ii) consequences and risks;
    - (iii) the safety risk management process, including roles and responsibilities; and
    - (iv) safety reporting and the organisation's safety reporting system(s) .
- (b) Managers and supervisors
  - (1) Safety training should address safety responsibilities, including promoting the SMS and engaging operational personnel in hazard reporting;
  - (2) In addition to the training objectives established for operational personnel, training objectives for managers and supervisors should include a detailed knowledge of the safety process, hazard identification and safety risk management and mitigation, and change management;
  - (3) In addition to the contents specified for operational personnel, the training contents for supervisors and managers should include safety data analysis.
- (c) Senior managers

- (1) Safety training should include safety responsibilities, including compliance with European Union, national and the organisation's own safety requirements, allocation of resources, ensuring effective inter-departmental safety communication, and active promotion of the safety management system;
  - (2) In addition to the objectives of the two previous employee groups, safety training should include safety assurance and safety promotion, safety roles and responsibilities, and establishing acceptable levels of safety.
- (d) **Accountable manager**
- The training should provide the accountable manager with a general awareness of the organisation's safety management system, including safety management system roles and responsibilities, safety policy and objectives, safety risk management, and safety assurance.

## **AMC1 ADR.OR.D.005(b)(9) Management system**

*ED Decision 2014/012/R*

### **SAFETY COMMUNICATION**

- (a) The aerodrome operator should communicate safety management system objectives and procedures to all operational personnel, and the safety management system and its application should be evident in all aspects of operations.
- (b) Communication should flow between the safety manager and operational personnel throughout the organisation. The safety manager should communicate the performance of the organisation's safety management system through suitable means. The safety manager should, also, ensure that lessons learned from investigations, safety related events, or other safety related experiences, both internally and from other organisations, are distributed widely.
- (c) Safety communication should aim to:
  - (1) ensure that all staff are fully aware of the safety management system;
  - (2) convey safety-critical information;
  - (3) explain why particular actions are taken; and
  - (4) explain why safety procedures are introduced or changed.

## **GM1 ADR.OR.D.005(b)(9) Management system**

*ED Decision 2014/012/R*

### **SAFETY COMMUNICATION**

- (a) An aerodrome operator, may use the following tools to communicate safety information:
  - (1) Safety Management System Manual;
  - (2) safety processes and procedures;
  - (3) safety newsletters, notices, and bulletins; and
  - (4) websites or emails;

- (b) Regular meetings with personnel where information, actions, and procedures are discussed may be used to communicate safety matters.

## AMC1 ADR.OR.D.005(b)(10) Management system

*ED Decision 2014/012/R*

### COORDINATION OF THE AERODROME EMERGENCY RESPONSE PLAN

The coordination of the aerodrome emergency response plan, established in accordance with the requirements contained in [Part-ADR.OPS](#), with the safety management system should ensure continuous improvement of the systems and procedures contained within the plan.

## GM1 ADR.OR.D.005(b)(10) Management system

*ED Decision 2014/012/R*

### COORDINATION OF THE AERODROME EMERGENCY RESPONSE PLAN

Continuous improvement of the systems and procedures contained within the aerodrome emergency response plan may, amongst others, be obtained by:

- (a) conducting a review of the relevant parts of the emergency response plan after a full or partial exercise;
- (b) debriefing and analysing the emergency response operations after an emergency situation; and
- (c) developing new emergency procedures or systems as part of the emergency response plan when new hazards are identified by the safety management system,

to ensure, amongst others, the coordination with the emergency response plans of other interfacing organisations.

## AMC1 ADR.OR.D.005(b)(11) Management system

*ED Decision 2014/012/R*

### COMPLIANCE MONITORING

- (a) Compliance monitoring
  - (1) The implementation and use of a compliance monitoring process should enable the aerodrome operator to monitor compliance with the relevant requirements of this Part, [Part-ADR.OPS](#), as well as any other applicable regulatory requirements, or requirements established by the aerodrome operator.

The aerodrome operator should specify the basic structure of the compliance monitoring applicable to the activities conducted.

The compliance monitoring should be properly implemented, maintained and continually reviewed and improved as necessary.

Compliance monitoring should be structured according to the size of organisation and the complexity of the activities to be monitored, including those which have been subcontracted.

Compliance monitoring should include a feedback system of findings to the accountable manager to ensure effective implementation of corrective actions as necessary.

- (2) An aerodrome operator should monitor compliance with the procedures it has designed, to ensure safe activities. In doing so, an aerodrome operator should as a minimum, and where appropriate, monitor compliance with:
  - (i) privileges of the aerodrome operator;
  - (ii) manuals, logs, and records;
  - (iii) training standards;
  - (iv) required resources; and
  - (v) management system procedures and manuals.
- (b) Organisational set-up
  - (1) A person should be responsible for compliance monitoring.

The accountable manager, with regards to his/her direct accountability for safety, should ensure, in accordance with [ADR.D.015\(a\)](#), that sufficient resources are allocated for compliance monitoring. In the case the person responsible for the compliance monitoring acts also as safety manager, the accountable manager should ensure that sufficient resources are allocated to both functions, taking into account the size of the aerodrome operator, and the nature and complexity of its activities.
  - (2) The independence of the compliance monitoring should be established by ensuring that audits and inspections are carried out by personnel not responsible for the function, procedure, etc. being audited.
  - (3) Personnel involved in compliance monitoring should have access to any part of the aerodrome organisation, and any contracted organisation as required.
- (c) Compliance monitoring documentation
  - (1) Relevant documentation should include the relevant part(s) of the aerodrome operator's management system documentation.
  - (2) In addition, relevant documentation should also include the following:
    - (i) terminology;
    - (ii) specified activity standards;
    - (iii) a description of the organisation of the aerodrome operator;
    - (iv) the allocation of duties and responsibilities;
    - (v) procedures to ensure regulatory compliance;
    - (vi) the compliance monitoring programme, reflecting:
      - (A) schedule of the monitoring programme;
      - (B) audit procedures;
      - (C) reporting procedures;

- 
- (D) follow-up and corrective action procedures; and
  - (E) recording system;
  - (vii) the training syllabus referred to in (d)(2); and
  - (viii) document control.
- (d) Training
- (1) Correct and thorough training is essential to optimise compliance in every aerodrome operator. In order to achieve significant outcomes of such training, the operator should ensure that all personnel understand the objectives as laid down in the operator's management system documentation.
  - (2) Those responsible for managing the compliance monitoring should receive training on this task. Such training should cover the requirements of compliance monitoring, manuals and procedures related to the task, audit techniques, reporting, and recording.
  - (3) Time should be provided to train the personnel involved in compliance management, and for briefing the remaining of the personnel.
  - (4) The allocation of time and resources should be based on the volume and complexity of the activities concerned.
- (e) Compliance monitoring — audit scheduling
- (1) A defined audit schedule to be completed during a specified calendar period and a periodic review cycle for each area should be established. The compliance monitoring itself should also be audited according to a defined audit schedule. The schedule should allow for unscheduled audits when trends are identified. Follow-up audits should be scheduled to verify that corrective action was carried out, and that it was effective and completed, in accordance with the policies and procedures specified in the aerodrome manual.
  - (2) The aerodrome, its management system key processes, procedures and its operation should be audited within the first 12 months since the date of the issuance of the certificate.
  - (3) After that, the aerodrome operator should consider the results of its safety (risk) assessments and of its past compliance monitoring activities, in order to adapt the calendar period within which an audit or a series of audits should be conducted, to cover the whole aerodrome, its management system key processes, procedures and its operation in a manner, and at intervals set out in the aerodrome manual. This calendar period, should be consistent with the relevant competent authority's oversight planning cycle and may be increased, up to 36 months, in coordination with the competent authority, provided that there are no level 1 findings, and subject to the aerodrome operator having a good record of rectifying findings in a timely manner.

## GM1 ADR.OR.D.005(b)(11) Management system

ED Decision 2014/012/R

### COMPLIANCE MONITORING — GENERAL

- (a) The organisational set-up of the compliance monitoring should reflect the size of the aerodrome operator, and the nature and complexity of its activities. The person responsible for the compliance monitoring may perform all audits and inspections himself/herself, or appoint one or more auditors by choosing personnel having the related competence as defined in paragraph (b) of [AMC2 ADR.OR.D.005\(b\)\(11\)](#) either from within, or outside the aerodrome operator.
- (b) Regardless of the option chosen, it must be ensured that the independence of the audit function is not affected, in particular, in cases where those performing the audit or inspection are also responsible for other functions for the aerodrome operator.
- (c) In case external personnel are used to perform compliance audits or inspections:
  - (1) any such audits or inspections are performed under the responsibility of the person responsible for the compliance monitoring; and
  - (2) the aerodrome operator remains responsible to ensure that the external personnel has relevant knowledge, background, and experience as appropriate to the activities being audited or inspected, including knowledge and experience in compliance monitoring.
- (d) The aerodrome operator retains the ultimate responsibility for the effectiveness of the compliance monitoring, in particular for the effective implementation and follow-up of all corrective actions.

## AMC2 ADR.OR.D.005(b)(11) Management system

ED Decision 2014/012/R

### RESPONSIBILITY FOR COMPLIANCE MONITORING

- (a) The responsibility for the compliance monitoring should:
  - (1) be with a person who has direct access to, and is responsible to the accountable manager;
  - (2) not be with one of the persons referred to in [ADR.OR.D.015\(b\)](#) or [ADR.OR.D.015\(c\)](#), except that in less complex aerodrome organisations/operations, it may also be with the accountable manager or the person referred to in [ADR.OR.D.015\(c\)](#).
- (b) Persons allocated the responsibility for the compliance monitoring should have:
  - (1) adequate experience and expertise in aerodrome operations, or aerodrome maintenance, or similar area;
  - (2) adequate knowledge of, and experience in safety management and quality assurance;
  - (3) knowledge of the aerodrome manual; and
  - (4) comprehensive knowledge of the applicable requirements in the area of aerodromes.



## AMC1 ADR.OR.D.005(c) Management system

*ED Decision 2014/012/R*

### **AERODROME OPERATOR MANAGEMENT SYSTEM DOCUMENTATION**

The aerodrome operator should ensure that the documented management system key processes include a process for making personnel aware of their responsibilities, as well as its amendment procedure.

The aerodrome operator's management system documentation should, at least, include the following information:

- (a) a statement signed by the accountable manager to confirm that the aerodrome operator will continuously work in accordance with the applicable requirements and the operator's documentation;
- (b) the aerodrome operator's scope of activities;
- (c) the titles and names of persons referred to in [ADR.OR.D.015](#) and [AMC2 ADR.OR.D.005\(b\)\(11\)](#);
- (d) an organisation chart showing the lines of responsibility between the nominated persons;
- (e) a general description and location of the facilities;
- (f) procedures specifying how the aerodrome operator ensures compliance with the applicable requirements;
- (g) the amendment procedure for the operator's management system documentation; and
- (h) safety management system outputs.

## AMC2 ADR.OR.D.005(c) Management system

*ED Decision 2014/012/R*

### **AERODROME OPERATOR SAFETY MANAGEMENT MANUAL**

- (a) In cases where safety management is set out in a Safety Management Manual, it should be the key instrument for communicating the approach to safety for the aerodrome operator. The Safety Management Manual should document all aspects of safety management, including the safety policy, objectives, procedures, and individual safety responsibilities.
- (b) The contents of the Safety Management Manual should include:
  - (1) scope of the safety management system;
  - (2) safety policy and objectives;
  - (3) safety responsibilities of key safety personnel;
  - (4) documentation control procedures;
  - (5) safety assessment process, including hazard identification and risk management schemes;
  - (6) monitoring of implementation and effectiveness of safety actions, and risk mitigation measures;

- (7) safety performance monitoring;
- (8) safety reporting (including hazard reporting) and investigation;
- (9) coordination of emergency response planning;
- (10) management of change (including organisational changes with regard to safety responsibilities);
- (11) safety promotion; and
- (12) safety management system outputs.

## GM1 ADR.OR.D.005(c) Management system

*ED Decision 2014/012/R*

### AERODROME OPERATOR MANAGEMENT SYSTEM DOCUMENTATION

It is not required to duplicate information in several manuals. The Safety Management Manual is considered to be a part of the aerodrome manual.

## ADR.OR.D.007 Management of aeronautical data and aeronautical information

*Regulation (EU) No 139/2014*

- (a) As part of its management system, the aerodrome operator shall implement and maintain a quality management system covering:
  - (1) its aeronautical data activities; and
  - (2) its aeronautical information provision activities.
- (b) The aerodrome operator shall define procedures for meeting the safety and security management objectives with respect to:
  - (1) aeronautical data activities; and
  - (2) aeronautical information provision activities.

*[applicable until 26 January 2022]*

## ADR.OR.D.007 Management of aeronautical data and aeronautical information

*Delegated Regulation (EU) 2020/2148*

- (a) As part of its management system, the aerodrome operator shall implement and maintain a quality management system covering the following activities:
  - (1) its aeronautical data activities;
  - (2) its aeronautical information provision activities.

- (b) The aerodrome operator shall, as part of its management system, establish a security management system to ensure the security of operational data it receives, or produces, or otherwise employs, so that access to that operational data is restricted only to those authorised.
- (c) The security management system of the aerodrome operator shall define the following elements:
  - (1) the procedures relating to data security risk assessment and mitigation, security monitoring and improvement, security reviews and lesson dissemination;
  - (2) the means designed to detect security breaches and to alert personnel with appropriate security warnings;
  - (3) the means of controlling the effects of security breaches and of identifying recovery action and mitigation procedures to prevent reoccurrence.
- (d) The aerodrome operator shall ensure the security clearance of its personnel with respect to aeronautical data security.
- (e) The aerodrome operator shall take the necessary measures to protect its aeronautical data against cyber security threats.

[applicable from 27 January 2022]

## AMC1 ADR.OR.D.007(a) Management of aeronautical data and aeronautical information

ED Decision 2014/012/R

### QUALITY MANAGEMENT SYSTEM FOR AERONAUTICAL DATA AND AERONAUTICAL INFORMATION PROVISION ACTIVITIES

- (a) A quality management system supporting the origination, production, storage, handling, processing, transfer, and distribution of aeronautical data and aeronautical information should:
  - (1) define the quality policy in such a way as to meet the needs of different users as closely as possible;
  - (2) set up a quality assurance programme that contains procedures designed to verify that all operations are being conducted in accordance with the applicable requirements, standards and procedures, including the relevant requirements of [Part-ADR.OPS](#);
  - (3) provide evidence of the functioning of the quality system by means of manuals and monitoring documents;
  - (4) appoint management representatives to monitor compliance with, and adequacy of, procedures to ensure safe and efficient operational practices; and
  - (5) perform reviews of the quality system in place, and take remedial actions, as appropriate.
- (b) An EN ISO 9001 certificate, issued by an appropriately accredited organisation, is considered as an Acceptable Means of Compliance.

[applicable until 26 January 2022 — ED Decision 2021/003/R]

## GM1 ADR.OR.D.007(a) Management of aeronautical data and aeronautical information

ED Decision 2014/012/R

### QUALITY MANAGEMENT SYSTEM FOR AERONAUTICAL DATA AND AERONAUTICAL INFORMATION PROVISION ACTIVITIES

An aerodrome operator does not need to duplicate functions and activities in order to discharge the responsibilities related to the management of aeronautical data and aeronautical information provision activities.

In this respect, the compliance monitoring may be used for the purposes of ensuring compliance with the relevant requirements for management of aeronautical data and aeronautical information provision activities.

## AMC1 ADR.OR.D.007(b) Management of aeronautical data and aeronautical information

ED Decision 2014/012/R

### SECURITY MANAGEMENT FOR AERONAUTICAL DATA AND AERONAUTICAL INFORMATION PROVISION ACTIVITIES

- (a) The security management objectives should be:
- (1) to ensure the security of aeronautical data and aeronautical information received, produced, or otherwise employed so that it is protected from interference, and access to it is restricted only to those authorised; and
  - (2) to ensure that the security management measures meet appropriate national, EU, or international requirements for critical infrastructure and business continuity, and international standards for security management, including:
    - (i) ISO/IEC 17799:2005 — Information technology — Security techniques — Code of practice for information security management;
    - (ii) ISO 28000:2007: — Specification for security management systems for the supply chain.
- (b) Regarding the ISO standards, the relevant certificates issued by an appropriately accredited organisation, are considered as an Acceptable Means of Compliance.

## GM1 ADR.OR.D.007(b) Management of aeronautical data and aeronautical information

ED Decision 2021/003/R

### INFORMATION SECURITY THREAT

Information security threat may be any circumstance or event with the potential to adversely impact the operation, systems and/or constituents due to human action (accidental, casual or purposeful, intentional or unintentional, mistaken) resulting from unauthorised access, use, disclosure, denial, disruption, modification, or destruction of information and/or information system interfaces. This

includes malware and the effects of external systems on dependent systems but does not include physical threats.

[applicable from 27 January 2022]

## ADR.OR.D.010 Contracted activities

Regulation (EU) No 139/2014

- (a) Contracted activities include all activities within the aerodrome operator's scope in accordance with the terms of the certificate that are performed by other organisations either itself certified to carry out such activity or if not certified, working under the aerodrome operator's approval. The aerodrome operator shall ensure that when contracting or purchasing any part of its activity, the contracted or purchased service or equipment or system conforms to the applicable requirements.
- (b) When an aerodrome operator contracts any part of its activity to an organisation that is not itself certified in accordance with this Part to carry out such activity, the contracted organisation shall work under the approval and oversight of the aerodrome operator. The aerodrome operator shall ensure that the Competent Authority is given access to the contracted organisation, to determine continued compliance with the applicable requirements.

## AMC1 ADR.OR.D.010 Contracted activities

ED Decision 2014/012/R

### RESPONSIBILITY WHEN CONTRACTING ACTIVITIES

- (a) An aerodrome operator may contract certain activities to external organisations.
- (b) A written agreement should exist between the aerodrome operator and the contracted organisation, clearly defining the contracted activities and the applicable requirements.
- (c) The contracted safety related activities relevant to the agreement should be included in the aerodrome operator's safety management and compliance monitoring programmes.
- (d) The aerodrome operator should ensure that the contracted organisation has the necessary authorisation, declaration, or approval when required, and commands the resources and competence to undertake the task; to this end, a prior audit of the contracted party should be conducted to ensure that the contracted organisation meets the applicable requirements, and the requirements specified by the aerodrome operator itself.

## GM1 ADR.OR.D.010 Contracted activities

ED Decision 2014/012/R

### CONTRACTING — GENERAL

- (a) Contracted activities to external organisations for the provision of services may include areas such as:
  - (1) maintenance of the aerodrome and equipment;
  - (2) surveying for aeronautical data;

- (3) apron management services;
  - (4) training;
  - (5) rescue and firefighting services;
  - (6) aerodrome design, etc.
- (b) In case of contracted activities, the aerodrome operator should define relevant management responsibilities within its own organisation.
- (c) The ultimate responsibility for the product or service provided by contracted organisations should always remain with the aerodrome operator.

## GM2 ADR.OR.D.010 Contracted activities

*ED Decision 2014/012/R*

### RESPONSIBILITY WHEN CONTRACTING ACTIVITIES

- (a) Regardless of the approval status of the contracted organisation, the contracting aerodrome operator is responsible to ensure that all contracted activities are subject to hazard identification, safety (risk) assessment and mitigation, as well as compliance monitoring.
- (b) When the contracted organisation is itself certified to carry out the contracted activities, the aerodrome operator's compliance monitoring should at least check that the approval effectively covers the contracted activities, and that it is still valid.

## ADR.OR.D.015 Personnel requirements

*Regulation (EU) No 139/2014*

- (a) The aerodrome operator shall appoint an accountable manager, who has the authority for ensuring that all activities can be financed and carried out in accordance with the applicable requirements. The accountable manager shall be responsible for establishing and maintaining an effective management system.
- (b) The aerodrome operator shall nominate persons responsible for the management and supervision of the following areas:
- (1) operational services of the aerodrome; and
  - (2) maintenance of the aerodrome.
- (c) The aerodrome operator shall nominate a person or group of persons responsible for the development, maintenance and day-to-day management of the safety management system.
- Those persons shall act independently of other managers within the organisation, shall have direct access to the accountable manager and to appropriate management for safety matters and shall be responsible to the accountable manager.
- (d) The aerodrome operator shall have sufficient and qualified personnel for the planned tasks and activities to be performed in accordance with the applicable requirements.

- (e) The aerodrome operator shall assign a sufficient number of personnel supervisors to defined duties and responsibilities, taking into account the structure of the organisation and the number of personnel employed.
- (f) The aerodrome operator shall ensure that personnel involved in the operation, maintenance and management of the aerodrome are adequately trained in accordance with the training programme.

## AMC1 ADR.OR.D.015(a) Personnel requirements

*ED Decision 2014/012/R*

### ACCOUNTABLE MANAGER

- (a) **Accountable Manager — General**
  - (1) The accountable manager should:
    - (i) ensure that all necessary resources are available to operate the aerodrome in accordance with the applicable requirements and the aerodrome manual;
    - (ii) ensure that if there is a reduction in the level of resources or abnormal circumstances which may affect safety, the required reduction in the level of operations at the aerodrome is implemented;
    - (iii) establish, implement, and promote the safety policy; and
    - (iv) ensure compliance with relevant applicable requirements, certification basis, and the organisation's safety management system, as well as its quality management system with regard to aeronautical data and aeronautical information provision activities.
  - (2) The accountable manager should have:
    - (i) an appropriate level of authority within the aerodrome operator's organisation to ensure that activities are financed and carried out to the standard required;
    - (ii) knowledge and understanding of the documents that prescribe relevant aerodrome safety standards;
    - (iii) understanding of the requirements for competence of aerodrome management personnel, so as to ensure that competent persons are in place;
    - (iv) knowledge and understanding of safety, quality, and security management systems related principles and practices, and how these are applied within the organisation;
    - (v) knowledge of the role of the accountable manager; and
    - (vi) knowledge and understanding of the key issues of risk management within the aerodrome.
- (b) **Accountable manager — Delegation of responsibilities**

- (1) The technical knowledge and understanding expected by an accountable manager is high level, with particular reference to his/her own role in ensuring that standards are maintained.
- (2) During periods of absence, the day-to-day responsibilities of the accountable manager may be delegated; however, the accountability ultimately remains with the accountable manager.
- (3) Depending on the size and the complexity of operations, the accountable manager may delegate his/her responsibilities in the area of training, by nominating a training manager whose responsibilities should be the establishment, coordination, implementation of training programmes, and relevant record keeping of personnel training, as well as of the proficiency check programmes.

In any case, the accountability, ultimately, remains with the accountable manager.

## GM1 ADR.OR.D.015(a) Personnel requirements

ED Decision 2014/012/R

### ACCOUNTABLE MANAGER

Depending on the size, structure and complexity of the organisation, the accountable manager may be:

- (a) the chief executive officer (CEO);
- (b) the chief operating officer (COO);
- (c) the chairperson of the board of directors;
- (d) a partner; or
- (e) the proprietor.

The appointment of an accountable manager who is given the required authorities and responsibilities, requires that the individual has the necessary attributes to fulfil the role. The accountable manager may have more than one function in the organisation. Nonetheless, the accountable manager's role is to instil safety as a core organisational value, and to ensure that the safety management system is properly implemented and maintained through the allocation of resources and tasks.

## AMC1 ADR.OR.D.015(b) Personnel requirements

ED Decision 2014/012/R

### NOMINATED PERSONS

- (a) General
  - (1) A description of the functions of the nominated persons, including their names, as well as clearly defined responsibilities and authorisations, should be contained in the aerodrome manual. Nominated persons should have adequate resources available to perform their duties.



- (2) The aerodrome operator should make arrangements to ensure adequate continuity of supervision in the absence of nominated persons.
  - (3) The person nominated by the aerodrome operator should not be nominated by another aerodrome operator, unless agreed with the Competent Authority.
  - (4) Persons nominated should be foreseen to work sufficient hours to fulfil the management functions associated with the scale and complexity of the operation.
  - (5) A nominated person may hold more than one of the nominated posts if such an arrangement is considered suitable and properly matched to the aerodrome operator's organisation, and the complexity of its operations.
- (b) Competence of nominated persons
- The manager of Operational Services and the Maintenance manager should have:
- (1) adequate practical experience and expertise in aerodrome operations or maintenance (or similar area) respectively;
  - (2) comprehensive knowledge of the applicable requirements in the area of aerodromes;
  - (3) appropriate level of knowledge of safety and quality management; and
  - (4) knowledge of the aerodrome manual.

## GM1 ADR.OR.D.015(b) Personnel requirements

*ED Decision 2014/012/R*

### COMBINATION OF NOMINATED PERSONS RESPONSIBILITIES

- (a) The acceptability of a single person holding more than one post, possibly in combination with being the accountable manager, should depend upon the aerodrome operator's organisation, and the complexity of its operations. The two main areas of concern should be competence, and an individual's capacity to meet his/her responsibilities.
- (b) As regards competence in different areas of responsibility, there should not be any difference from the requirements applicable to persons holding only one post.
- (c) The capacity of an individual to meet his/her responsibilities should primarily be dependent upon the complexity of the aerodrome operator's organisation and its operations. However, the complexity of the aerodrome operator's organisation, or of its operation may prevent, or limit, combinations of posts.

## AMC1 ADR.OR.D.015(c) Personnel requirements

*ED Decision 2014/012/R*

### SAFETY MANAGER

- (a) The safety manager should be the focal point and responsible for the development, administration, and maintenance of an effective safety management system (see also [AMC1 ADR.OR.D.005\(b\)\(1\)](#)).
- (b) The role of the safety manager should be to:

- (1) facilitate hazard identification, risk analysis, and management;
  - (2) monitor the implementation and functioning of the safety management system, including the necessary safety actions;
  - (3) manage the safety reporting system of the aerodrome;
  - (4) provide periodic reports on safety performance;
  - (5) ensure maintenance of safety management documentation;
  - (6) ensure that there is safety management training available, and that it meets acceptable standards;
  - (7) provide advice on safety matters; and
  - (8) initiate and participate in internal occurrence/accident investigations.
- (c) The safety manager should have:
- (1) adequate practical experience and expertise in aerodrome operations, or aerodrome maintenance, or similar area;
  - (2) adequate knowledge of safety and quality management;
  - (3) adequate knowledge of the aerodrome manual; and
  - (4) comprehensive knowledge of the applicable requirements in the area of aerodromes.
- (d) The safety manager should not be one of the persons referred to in [ADR.OR.D.015\(b\)](#) or [AMC2 ADR.OR.D.005\(b\)\(11\)](#). However, in the case of less complex aerodrome organisations/operations, the safety manager may be the accountable manager, or one of the persons referred to in [ADR.OR.D.015\(b\)](#), or [AMC2 ADR.OR.D.005\(b\)\(11\)](#), or any other person at appropriate management level, provided that he/she can act independently of other managers within the organisation of the aerodrome operator, and has direct access to the accountable manager and to appropriate management for safety matters.

## AMC1 ADR.OR.D.015(d) Personnel requirements

ED Decision 2014/012/R

### DETERMINATION OF PERSONNEL NEEDS AND QUALIFICATIONS

- (a) The aerodrome operator should determine the required personnel for the planned tasks.
- (b) The aerodrome operator should determine the required personnel qualifications, in accordance with the applicable requirements (and the national and European Union legislation where applicable), and include them in the aerodrome manual. A documented system with defined responsibilities should be in place, in order to identify any needs for changes with regard to personnel qualifications.

## GM1 ADR.OR.D.015(d) Personnel requirements

*ED Decision 2014/012/R*

### QUALIFICATION OF PERSONNEL

The term ‘qualified’ denotes fitness for the purpose. This may be achieved through fulfilment of the necessary conditions such as completion of required training, or acquisition of a diploma or degree, or through the gaining of suitable experience. It, also, includes the ability, capacity, knowledge, or skill that matches or suits an occasion, or makes someone eligible for a duty, office, position, privilege, or status.

Certain posts may, by nature, be associated with the possession of certain qualifications in a specific field (e.g. rescue and firefighting, civil, mechanical or electrical engineering, wildlife biology, etc.). In such cases, the person occupying such a post is expected to possess the necessary qualifications at a level that is in accordance with the applicable national or European Union legislation.

## AMC1 ADR.OR.D.015(d);(e) Personnel requirements

*ED Decision 2014/012/R*

### DISTRIBUTION OF RULES AND PROCEDURES

The aerodrome operator should have a system in place to distribute the rules and procedures to personnel to exercise their duties and responsibilities.

## GM1 ADR.OR.D.015(d);(e) Personnel requirements

*ED Decision 2014/012/R*

### DISTRIBUTION MEANS OF RULES AND PROCEDURES

The aerodrome operator may use electronic means, or conventional means to distribute rules and procedures to personnel. The method used should verify that the information reached the intended recipient.

## ADR.OR.D.017 Training and proficiency check programmes

*Delegated Regulation (EU) 2020/2148*

- (a) The aerodrome operator shall establish and implement a training programme for personnel involved in the operation, maintenance and management of the aerodrome, to ensure their continued competence, and that they are aware of the rules and procedures relevant to operation of the aerodrome and the relationship of their functions and tasks to the aerodrome operation as a whole.
- (b) The training referred to in point (a) shall:
  - (1) include initial, recurrent, refresher and continuation training;
  - (2) be appropriate to the functions and tasks for the personnel;
  - (3) include the applicable operational procedures and requirements of the aerodrome, as well as driving.

- 
- (c) The aerodrome operator shall ensure that any other personnel, including personnel of other organisations that operate or provide services at the aerodrome, allowed unescorted access to the movement area and other operational areas of the aerodrome, is adequately trained and qualified for such unescorted access.
- (d) The training referred to in point (c) shall:
- (1) include initial, recurrent, refresher and continuation training;
  - (2) include the applicable operational procedures and requirements of the aerodrome, as well as driving.
- (e) The aerodrome operator shall ensure that personnel referred to in points (a) and (c) have successfully completed the necessary initial training prior to being allowed:
- (1) to perform their duties unattended;
  - (2) unescorted access to the movement area and other operational areas of the aerodrome.
- The initial training shall include theoretical and practical training of adequate duration and competence assessments of the personnel following the provision of the training.
- (f) In order to continue to perform their duties unattended and being allowed unescorted access to the movement area and other operational areas of the aerodrome and unless otherwise specified in this Part and [Part-ADR.OPS](#), the aerodrome operator shall ensure that personnel referred to in points (a) and (c) have been trained on the rules and procedures relevant to operation of the aerodrome by successfully completing:
- (1) recurrent training, at intervals not exceeding 24 months since the completion of their initial training. If the recurrent training is undertaken within the last 3 calendar months of the interval, the new interval period shall be counted from the expiry date of the original interval;
  - (2) refresher training, prior to performing their duties unattended or being allowed unescorted access to the movement area or other operational area of the aerodrome, when they are absent from their duties for a period not less than 3 and not more than 12 consecutive months. In case of absence beyond 12 consecutive months, such personnel shall undergo initial training in accordance with point (c);
  - (3) continuation training due to changes to their operating environment or assigned tasks, as necessary.
- (g) The aerodrome operator shall establish and implement a proficiency check programme for personnel referred to in point (a), and ensure for personnel referred to in point (c) that they have demonstrated their capabilities in the performance of their tasks, in accordance with a proficiency check programme, in order to ensure:
- (1) their continued competence;
  - (2) that they are aware of the rules and procedures relevant to their functions and tasks.

Unless otherwise specified in this Part and [Part-ADR.OPS](#), the aerodrome operator shall ensure that persons referred to in points (a) and (c) undergo proficiency checks at intervals not exceeding 24 months since the completion of their initial training.

- (h) The aerodrome operator shall ensure that:
- (1) adequately qualified and experienced instructors for the provision of training and assessors for the assessments and the proficiency checks are used;
  - (2) suitable facilities, means and equipment are used for the provision of the training and, where applicable, for the conduct of the proficiency checks.
- (i) The aerodrome operator shall establish and implement procedures for the implementation of the training and proficiency check programmes and shall:
- (1) maintain appropriate qualification, training and proficiency check records to demonstrate compliance with this requirement;
  - (2) upon request, make such records available to its personnel concerned;
  - (3) if a person is employed by another employer, upon request, make such records of that person available to that new employer.

## AMC1 ADR.OR.D.017(a);(b) Training and proficiency check programmes

ED Decision 2021/003/R21/003/R

### TRAINING OF AERODROME PERSONNEL — GENERAL

- (a) The training programme should cover all personnel:
- (1) involved in the operation, maintenance, and management of the aerodrome (supervisors, managers, senior managers, and the accountable manager); and
  - (2) operating unescorted on the movement area, and other operational areas of the aerodrome, and which are related to the aerodrome operator
- regardless of their level in the organisation.
- (b) The training programme should include safety management system training whose level of detail should be appropriate to the individual's responsibility and involvement in the safety management system and should also include human and organisational factors.
- (c) The training programme should consist of the following:
- (1) a process to identify training standards, including:
    - (i) syllabi, duration, and frequency for each type of training and area of activity for the persons mentioned in point (a), including for the instructors and assessors;
    - (ii) method(s) for delivery of training and competency assessment; minimum performance to be achieved by trainees; and
    - (iii) track completion of required training;
  - (2) a validation process that measures the effectiveness of training;
  - (3) initial job-specific training;
  - (4) practical training;

- (5) recurrent training;
  - (6) refresher training; and
  - (7) continuation training.
- (d) The training programme should identify training responsibilities and contain procedures:
- (1) for training and competency assessment of the trainees;
  - (2) to be applied in the event that personnel do not achieve or maintain the required standards.
- (e) Training contents, syllabi and duration should comply with the requirements prescribed in [Part-ADR.OPS](#).
- (f) A training file should be developed for each employee, including management, and a system should be in place to assist in identifying and tracking employee training requirements, and verifying that personnel have received the required/planned training.
- (g) Information related to points (c) and (d), including the identified training standards and the related syllabi and frequency, should be included in the aerodrome manual.

## AMC1 ADR.OR.D.017(c);(d) Training and proficiency check programmes

ED Decision 2021/003/R

### TRAINING OF PERSONNEL OF OTHER ORGANISATIONS — GENERAL

With regard to the training of the personnel employed by other organisations which operate or provide services at the aerodrome, and which are allowed unescorted access to the movement area or other operational areas of the aerodrome, the provisions of [AMC1 ADR.OR.D.017\(a\);\(b\)](#) apply, except that the safety management system training may cover only the necessary elements (e.g. relevant procedures, safety reporting system, aerodrome safety programmes, etc.).

## GM1 ADR.OR.D.017(a);(b);(c);(d) Training and proficiency check programmes

ED Decision 2021/003/R

### TRAINING — GENERAL

- (a) Aerodrome operator's personnel
- (1) The purpose of the training programme is to ensure the initial and continued competence of the aerodrome operator's personnel to perform their duties, irrespective of their level in the organisation of the aerodrome. This is to be achieved by ensuring that each person receives initial, recurrent, and if necessary, refresher training (as a result of absence from duties), and other ad hoc training (e.g. due to the planned/implemented change to the aerodrome system, etc.), which is relevant to his or her function and tasks.
- One method to achieve this is by identifying the tasks of the employees and ensuring that each one of them receives the training that corresponds to such tasks.

For example, an employee whose tasks involve driving would need to undergo the relevant driving training (depending on the area of the aerodrome that he or she will operate in the course of his or her duties). Moreover, if the duties of that person involve also conducting inspections of the movement area, then the training plan for that employee would also need to include relevant training for that area.

Moreover, apart from this specific type of training, one would also consider the need for all personnel to undergo a safety management system training relevant to their duties.

- (2) As part of the process of the development of the training programme, there are also other issues that need to be considered, such as:
- (i) the content and duration of the courses;
  - (ii) the minimum performance required by the trainees;
  - (iii) the method to be used for the delivery of the training;
  - (iv) the way the competency assessments of the trainees will be performed; and
  - (v) the development of the relevant procedures to ensure that the training programme achieves its objectives and covers circumstances that may occur (e.g. the case where an employee fails to achieve the required competency level).

Consideration needs to be given to the fact that the relevant procedures would also need to address the organisation and implementation of the recurrent, refresher and continuation training.

- (b) Personnel of other organisations operating or providing services at the aerodrome

- (1) At the aerodrome environment, there may be also other organisations that operate or provide their services to other organisations or the aerodrome operator. Given that such activities may have an effect on safety and affect aerodrome operations, it is necessary to ensure that the personnel of these organisations that are allowed unescorted access to the movement area and other operational areas of the aerodrome, are trained in the applicable aerodrome's operational procedures and requirements, so that they are enabled to safely operate within the aerodrome environment (e.g. the apron, and sometimes on the manoeuvring area), sharing a common understanding about safety management.

To achieve this, the aerodrome operator needs to identify which are the applicable operational procedures and requirements for the relevant training of this type of personnel.

For instance, if an employee of another organisation needs to drive and work on the apron or on the manoeuvring area, then he or she would need to undergo the relevant training prior to being allowed to do so. This would involve the relevant driving training. On the other hand, the same person would be subject to certain aerodrome operational procedures and requirements which apply on this area, and so he or she would need to also receive training on these procedures and requirements (e.g. as part of the FOD control programme). Moreover, there is also an additional need for this employee to

receive a safety management system training relevant to their duties, e.g. how to file an occurrence report, etc.

- (2) As part of this process, the aerodrome operator would need to make considerations similar to the ones referred to in (a)(2) above, in order to ensure the continued competence and awareness of such personnel in the required fields.
- (3) In this way, the aerodrome operator is expected to be able to safely manage the interfaces it has with the other organisations present at the aerodrome. However, in order to ensure the successful implementation of this training, the aerodrome operator would need to cooperate and have relevant arrangements with the organisations whose employees need to complete this training. Depending on the situation and the solutions chosen in each case, the content of the arrangements may vary and cover different areas, such as the exchange of relevant information regarding absence of personnel for the organisation of a refresher training, the use of instructors or assessors proposed by these organisations for the implementation of the relevant part of the training programme, etc.
- (4) It is to be noted that the training related to the performance of the actual duties of this type of personnel (e.g. how to use its own organisation's equipment, or the internal procedures of that organisation, etc.) falls outside of the scope of this part of the training required under [ADR.OR.D.017](#).

(c) Understanding of the aerodrome system as a whole

It is important that the training provides all trainees with an understanding of the interdependencies between the various functions and actors at the aerodrome environment, and how their work is related to the functions and work of other personnel and organisations, so that they acquire a rather 'global' (as opposed to an 'isolated') perspective.

## AMC1 ADR.OR.D.017(e) Training and proficiency check programmes

ED Decision 2021/003/R

### INITIAL TRAINING

(a) Theoretical training

- (1) A suitable method (or suitable methods) for the delivery of each part of the required training should be identified and specified in the training programme.
- (2) The theoretical training should be delivered at appropriate training facilities, and the delivery of the training should be supported by means and equipment which are suitable for the training area covered.

Computer-based training may also be used, where interaction of the trainee(s) with other persons is not necessary and where the training material has been prepared, reviewed and updated by an instructor nominated in accordance with [AMC1 ADR.OR.D.017\(h\)](#). Where provided, such training should consider human factors principles, and, as a minimum, should also cater for the possibility for the trainees to ask questions and receive clarifications, as well as to provide feedback.

- (3) After the initial training, the acquired competency should be assessed. The competency assessment should be accomplished by using identified method(s), appropriate to the



training element to be assessed. Assessment procedures should be established, addressing, as a minimum, location(s), identity check and invigilation, and assessment discipline. Computer-based systems may be used for the assessment of the trainees provided that:

- (i) the assessment material is prepared, reviewed and updated by an assessor nominated in accordance with [AMC1 ADR.OR.D.017\(h\)](#); and
  - (ii) the assessment is conducted in a controlled facility and environment and in a manner that physically ensures the identity of the trainees during the assessment process.
- (4) Training elements that require individual practical participation may be combined with practical assessments.
- (b) Practical training
- (1) The practical training should follow the successful completion of the theoretical training and should be provided by an instructor nominated in accordance with [AMC1 ADR.OR.D.017\(h\)](#). The duration of the practical training should be appropriate to the area covered.
  - (2) A practical competency assessment should be conducted by an assessor nominated in accordance with [AMC1 ADR.OR.D.017\(h\)](#), following the completion of each practical training provided. Assessment procedures should be established, addressing, as a minimum, location(s), identity check, and assessment discipline.

## AMC2 ADR.OR.D.017(e) Training and proficiency check programmes

ED Decision 2021/003/R

### INITIAL TRAINING PROCESS — NEW EMPLOYEES

When an aerodrome operator employs personnel mentioned in point (a) of [AMC1 ADR.OR.D.017\(a\);\(b\)](#), who have already completed a training programme with another aerodrome operator, the current employer may, when determining the training needs required for the post to be filled by that employee, decide to credit training subjects on which the individual has already completed relevant training, as they are documented in his or her training records. In any case, no credit may be given for training areas which are specific to that aerodrome.

## GM1 ADR.OR.D.017(e) Training and proficiency check programmes

ED Decision 2021/003/R

### INITIAL TRAINING METHODS

- (a) The methods to be used for the delivery of the theoretical training include, but are not limited to, the following:
- (1) lecture;
  - (2) lesson/demonstration;
  - (3) case study;

- 
- (4) exercises, including computer-based practical exercises;
  - (5) facilitation;
  - (6) group work;
  - (7) interactive training; and
  - (8) supervised practices.
- (b) The methods to be used for the competency assessment of the trainees upon completion of the theoretical training could include:
- (1) practical demonstration;
  - (2) computer-based assessment;
  - (3) oral or written assessments;

or combinations of such methods, as appropriate.

When determining the method(s) to be used for the assessment of the trainees, the advantages and the limitations of each method, as well as the objectives of the training, would need to be taken into account.

For example, the oral assessment may be used to test the understanding of the trainees around certain issues, as well as the requirements governing them, to have a clearer indication that the trainee not only knows what he or she should be doing in a given case, but also why he or she should be doing it. However, the oral assessment requires considerable skills and it should be undertaken in a way that ensures consistency among individual assessors. On the other hand, written assessments may also be used to test the theoretical knowledge and to a lesser degree the understanding of the trainees. Written tests may be easier to administer and to ensure their consistency, particularly when using multiple-choice questions. However, multiple-choice questions may test knowledge, but they may not be appropriate for determining how a person would react in an operational situation. A written assessment may also be computer-based.

## AMC1 ADR.OR.D.017(f) Training and proficiency check programmes

*ED Decision 2021/003/R*

### RECURRENT, REFRESHER AND CONTINUATION TRAINING

(a) Recurrent training

The recurrent training may be only theoretical and should cover the areas addressed in the initial theoretical training provided. The recurrent training should be designed to review, reinforce or enhance the existing knowledge and skills of the trainees, and should also take into account the changes that have taken place in the content of the subjects covered by the initial training.

Upon completion of the recurrent training, an assessment of the trainee should be conducted.

(b) Refresher training

The refresher training may be only theoretical, and shorter than the recurrent training, and its content should take into account the length of the person's absence and the magnitude of the relevant changes that may have taken place during the period of absence of the employee.

Upon completion of the refresher training, an assessment of the trainee should be conducted (for the process of the assessment, see [AMC1 ADR.OR.D.017\(e\)](#)).

(c) Continuation training

Continuation training should be provided in the following cases:

(1) A person is assigned new/different tasks

In the case a person is to be assigned to different/additional tasks, an appropriate theoretical and practical training which covers any differences between his or her previous and future tasks should be completed. This differences training should be determined based on a comparison between the training required for the new tasks, and the training already completed by that person, as documented in his or her training records.

The provision of training should be followed by relevant competency assessment (for the process of the assessment, see [AMC1 ADR.OR.D.017\(e\)](#));

(2) A change is introduced to the operating environment of a person, which is of such nature and/or magnitude that it requires the training of the personnel (e.g. a new system to be used by the personnel concerned).

A method should be established and documented to be used for determining the need (or not) for, as well as the type(s) (theoretical, practical, or both) of, training to be provided following changes. The provision of training should be followed by a relevant competency assessment.

## AMC1 ADR.OR.D.017(g) Training and proficiency check programmes

ED Decision 2021/003/R

### PROFICIENCY CHECKS

(a) The purpose of the proficiency check is to establish the ability of an individual to perform satisfactorily, in accordance with applicable requirements and the content of the aerodrome manual as they relate to his or her tasks.

In particular, the proficiency check of the aerodrome operator's personnel should determine the performance of an individual regarding the tasks assigned to him or her. Regarding personnel of other organisations operating or providing services at the aerodrome, the objective of the proficiency check should be the assessment of the performance of the individual with regard to the applicable operational procedures and requirements of the aerodrome.

To this end, the elements that each proficiency check should cover should be identified and documented.

A proficiency check does not need to cover all associated elements at the same time; however, all elements of a proficiency check should be covered within the period specified in [ADR.OR.D.017\(g\)](#).

Depending on the situation, specialty and element checked, and provided that it will not affect the quality and completeness of the proficiency check, a single proficiency check may be used to cover more than one person. The person(s) to be checked should be made aware prior to the proficiency check.

Proficiency checks may be conducted during normal and/or abnormal/emergency conditions depending on the situation and the specialty of the person being checked.

- (b) The proficiency check programme should:
- (1) include a process to identify the frequency of proficiency checks, including for the instructors and assessors, and track completion of the required checks;
  - (2) identify checking responsibilities and relevant checking methods and procedures;
  - (3) include procedures to be applied in the event that personnel do not achieve the required standards; and
  - (4) include a validation process that measures the effectiveness of the programme.
- (c) Information related to the proficiency check programme should be included in the aerodrome manual.

## GM1 ADR.OR.D.017(g) Training and proficiency check programmes

*ED Decision 2021/003/R*

### PROFICIENCY CHECKS

Proficiency checks may be conducted at shorter intervals following, for example, an occurrence or to ensure that the person is able to apply in practice knowledge acquired due to updated training.

## AMC1 ADR.OR.D.017(h) Training and proficiency check programmes

*ED Decision 2021/003/R*

### INSTRUCTORS — ASSESSORS

- (a) The aerodrome operator should nominate instructors and assessors to be used for the implementation of the training and proficiency check programmes. The personnel to be nominated may also include contracted instructors or organisations for individual subjects.

The aerodrome operator may also nominate personnel proposed by organisations operating or providing services at the aerodrome to be used as instructors and assessors for the implementation of the respective part of the training and proficiency check programmes of these organisations' personnel. Irrespective of the solution chosen, the aerodrome operator remains responsible for the proper implementation of the training programme and the proficiency check programme in a consistent manner, and according to the relevant procedures and standards established by the aerodrome operator.

- (b) A person may be qualified and nominated both as an instructor and as an assessor by the aerodrome operator. However, such a person may not provide assessment for own instruction, courses, or material.
- (c) Instructors
- (1) Theoretical instruction should be given by appropriately qualified instructors. They should have:
    - (i) appropriate level and depth of knowledge in the field where instruction is to be given;
    - (ii) documented ability to use appropriate instructional techniques; and
    - (iii) adequate experience in the subject where instruction is to be given.
  - (2) Instruction on practical skills should be given by appropriately qualified instructors who:
    - (i) meet the theoretical knowledge, and the working experience requirements appropriate to the instruction being given;
    - (ii) have demonstrated the ability to instruct, and to use appropriate instructional techniques;
    - (iii) are proficient in instructional techniques in the areas in which it is intended to provide instruction; and
    - (iv) receive relevant training, in accordance with the training programme, to ensure that the instructional competencies are maintained.
- (d) Assessors
- The persons who are responsible for assessing the competence and skills of the personnel should:
- (1) have demonstrated the ability to assess the performance of, and conduct tests and checks in the areas covered by the training;
  - (2) receive relevant training, in accordance with the training programme, to ensure that the assessment standards are maintained up to date; and
  - (3) meet the theoretical knowledge requirements appropriate to the instruction being given and have adequate working experience in the area of instruction.

## AMC1 ADR.OR.D.017(i) Training and proficiency check programmes

ED Decision 2021/003/R

### PERSONNEL RECORDS

- (a) The aerodrome operator should use its record keeping system (see [AMC1 ADR.OR.D.035](#)) to record the following information for each person:
- (1) starting date of employment/ending date of employment (if applicable);
  - (2) area of activity;
  - (3) previous working experience;

- (4) qualifications;
  - (5) training (before entry and subsequent); and
  - (6) proficiency checks, including language proficiency as appropriate;
- (b) Latest changes should be reflected into personnel records.

## **AMC2 ADR.OR.D.017(i) Training and proficiency check programmes**

*ED Decision 2021/003/R*

### **TRAINING RECORDS**

- (a) Training programme — general

The records of the training sessions provided, should include as a minimum the following:

- (1) type of training, area of training and subjects covered;
- (2) names of participants/signed list of participants;
- (3) date and duration of training; and
- (4) names of the instructor and assessor.

- (b) Training records of individuals

The training records maintained for each individual should include as a minimum:

- (1) the name of the trainee;
- (2) the date(s) and the duration of the training;
- (3) the place where the training was received;
- (4) the name of the organisation that provided the training;
- (5) the subjects covered, and the methodology of the course;
- (6) any comments made by the instructor, if applicable;
- (7) the performance assessment of the trainee, as applicable; and
- (8) the name and signature of the instructor.

## **AMC3 ADR.OR.D.017(i) Training and proficiency check programmes**

*ED Decision 2021/003/R*

### **PROFFICIENCY CHECK RECORDS**

The proficiency check records maintained for each individual should include as a minimum:

- (a) the name of the person checked;
- (b) the date(s) and the duration of the proficiency check;
- (c) the methodology of the check conducted;
- (d) any comments made by the assessor;

- (e) the performance evaluation of the person checked; and
- (f) the name and signature of the assessor.

## ADR.OR.D.020 Facilities requirements

*Regulation (EU) No 139/2014*

- (a) The aerodrome operator shall ensure that adequate and appropriate facilities are available to its personnel or personnel employed by parties with whom it has contracted for the provision of aerodrome operational and maintenance services.
- (b) The aerodrome operator shall designate appropriate areas at the aerodrome to be used for the storage of dangerous goods transported through the aerodrome, in accordance with the Technical Instructions.

## GM1 ADR.OR.D.020(a) Facilities requirements

*ED Decision 2014/012/R*

### FACILITIES TO BE PROVIDED

Facilities should be provided to allow the performance of all tasks and activities in accordance with the applicable requirements. This includes, but is not limited to:

- (a) adequate offices, working space, and office equipment;
- (b) personnel protective equipment;
- (c) equipment necessary for inspecting the aerodrome and its facilities, such as clinometers, distance measurement devices, etc.; and
- (d) access to data sources necessary for the development and effective functioning of the safety management system and compliance monitoring of the aerodrome.

## AMC1 ADR.OR.D.020(b) Facilities requirements

*ED Decision 2014/012/R*

Designated areas may vary and include facilities such as cargo areas, or even open-air areas.

Aircraft stands should also be designated for aircrafts that carry dangerous goods.

## ADR.OR.D.025 Coordination with other organisations

*Regulation (EU) No 139/2014*

The aerodrome operator shall:

- (a) ensure that the management system of the aerodrome addresses the coordination and interface with the safety procedures of other organisations operating or providing services at the aerodrome; and
- (b) ensure that such organisations have safety procedures in place to comply with the applicable requirements of Regulation (EC) No 216/2008 and its Implementing Rules and the requirements laid down in the aerodrome manual.

## GM1 ADR.OR.D.025 Coordination with other organisations

ED Decision 2014/012/R

### COORDINATION OF SAFETY PROCEDURES

Coordination and interface with the safety procedures of other relevant organisations that are active at the aerodrome include, but is not limited to the following: aircraft operators, air navigation service providers, providers of apron management services, ground handling service providers, providers of services to persons with reduced mobility, aircraft maintenance organisations, flying training organisations, public authorities that operate on the movement area, as well as other organisations that perform activities independently at the aerodrome.

## GM2 ADR.OR.D.025 Coordination with other organisations

ED Decision 2014/012/R

### COMPLIANCE OF OTHER ORGANISATIONS

In order to ensure compliance of the organisations operating or providing services at the aerodrome, with the requirements of Regulation (EC) No 216/2008 and its Implementing Rules that are applicable to aerodromes and their operators, as well as with the content of the aerodrome manual, the aerodrome operator should:

- (a) conduct audits and inspections of such organisations through its compliance monitoring; and
- (b) establish procedures for the monitoring of related activities at the aerodrome.

## ADR.OR.D.027 Safety programmes

Regulation (EU) No 139/2014

The aerodrome operator shall:

- (a) establish, lead and implement programmes to promote safety and the exchange of safety-relevant information; and
- (b) encourage organisations operating or providing services at the aerodrome to be involved in such programmes.

## AMC1 ADR.OR.D.027 Safety programmes

ED Decision 2014/012/R

### SAFETY PROGRAMMES — AERODROME SAFETY COMMITTEES

- (a) The aerodrome operator should:
  - (1) organise, coordinate and implement programmes to promote safety at the aerodrome. Such programmes should include, but are not limited to:
    - (i) runway safety, including runway incursion and excursion prevention;
    - (ii) apron safety; and
    - (iii) FOD prevention;



- (2) coordinate and promote the exchange of information, and the joint investigation of occurrences, serious incidents, and accidents.
- (b) The aerodrome operator should establish, coordinate, and lead local aerodrome safety committees, and a Local Runway Safety Team, dealing with runway safety, apron safety, and the safety of the operations at the aerodrome in general. All relevant organisations operating or providing services at the aerodrome should participate to such aerodrome safety committees and the Local Runway Safety Team.

The local aerodrome safety committees and the Local Runway Safety Team should convene regularly, identify and review local safety issues, and examine possible solutions, and need for action. Minutes of such meetings should be kept. Procedures relevant to the functioning of local aerodrome safety committees and the Local Runway Safety Team should be included in the aerodrome manual.

## GM1 ADR.OR.D.027 Safety programmes

*ED Decision 2014/012/R*

### AERODROME SAFETY COMMITTEES

- (a) Manoeuvring area/Apron Safety Committee
- (1) The aerodrome operator should establish (a) Manoeuvring area/Apron Safety Committee(s);
  - (2) The Manoeuvring area/Apron Safety Committee(s) should have an advisory role to the aerodrome operator;
- (b) Management of Manoeuvring area /Apron Safety Committee(s)
- (1) The Manoeuvring area /Apron Safety Committee(s) should be chaired by an aerodrome operator's official, responsible for aerodrome operations; and
  - (2) The aerodrome operator's safety manager should act as the secretary of the Committee(s).
- (c) Composition of Manoeuvring area /Apron Safety Committee(s)
- Participation should include, but not limited to representatives of:
- (1) aerodrome users active in flight operations;
  - (2) aircraft ground handling services providers;
  - (3) aerodrome rescue and firefighting services;
  - (4) aerodrome operations;
  - (5) aerodrome wildlife management;
  - (6) aerodrome maintenance; and
  - (7) air navigation service provider(s).
- (d) Tasks
- The tasks of the Manoeuvring area /Apron Safety Committee(s) should be:

- (1) to receive and evaluate reports on operational safety issues;
- (2) to receive reports and statistical information on accidents and incidents, and propose solutions;
- (3) to advise on manoeuvring area/apron safety issues such as:
  - (i) promotion of apron safety discipline;
  - (ii) FOD prevention;
  - (iii) developing measures for safe operations;
  - (iv) considering actions to resolve manoeuvring area/apron safety problems;
  - (v) apron equipment issues;
  - (vi) adherence to vehicle traffic issues;
  - (vii) new and/or updated safety instructions;
  - (viii) personal protective clothing/equipment issues;
  - (ix) methods to develop and promote apron safety awareness initiatives,
  - (x) snow and ice clearance issues;
  - (xi) proposed aerodrome works;
  - (xii) proposed changes/developments to the movement area;
  - (xiii) standard operating procedures, etc.

## GM2 ADR.OR.D.027 Safety programmes

ED Decision 2014/012/R

### LOCAL RUNWAY SAFETY TEAM

#### (a) Context

As part of its runway safety programme, the aerodrome operator should establish and lead a Local Runway Safety Team and act on local runway safety issues, including runway incursion (including runway confusion) and excursion prevention.

A runway incursion is defined as ‘Any occurrence at an aerodrome involving the incorrect presence of an aircraft, vehicle, or person on the protected area of a surface designated for the landing and take-off of aircraft<sup>1</sup>.’

A runway excursion occurs when ‘An aircraft veers off or overruns the runway surface during either take-off or landing’.

#### (b) Local Runway Safety Team composition

<sup>1</sup> The ‘protected area of a surface designated for the landing and take-off of aircraft’ is to be interpreted as the physical surface of a runway, from the centreline to the holding point appropriate to the type of runway. Where operations are being conducted during low visibility operations this should be the holding point appropriate to the procedures in force. The ‘protected surface’ includes the ILS glide-path and localiser critical areas at all times, and the ILS sensitive areas during low visibility procedures.

Participation should include representatives from all interested parties with direct involvement in runway operations at the aerodrome, including, but is not limited, to:

- (1) aerodrome operations;
- (2) aerodrome engineering and maintenance;
- (3) air navigation service providers;
- (4) aircraft operators that operate of the aerodrome;
- (5) aerodrome rescue and firefighting services;
- (6) drivers having access on the manoeuvring area.

(c) Role

The role of the Local Runway Safety Team should be to advise the appropriate management on potential runway safety issues, and to recommend mitigating measures.

(d) Tasks

The Local Runway Safety Team may have the following tasks:

- (1) identification of potential runway safety issues, including the need for establishment of hot spots or other problem areas at the aerodrome and the review of the relevant entries of the AIP for accuracy;
- (2) developing and running local awareness campaigns, at suitable periods, including at the start of a busy season or before an unusual event, that focus on local issues, for example, producing and distributing local hot spot maps, or other guidance material considered as necessary; local awareness campaigns should be periodically refreshed to maintain interest and operational awareness of the relevant personnel;
- (3) monitoring the number, type and, the severity of runway incursions; disseminating safety recommendations delivered from accident and incident investigation findings as well as other relevant lessons learned e.g. from operational experience and best risk mitigation practices; sharing good practices to prevent runway incursions or excursions;
- (4) assisting in verifying that communications between air traffic controllers, or other Air Traffic Services personnel, pilots, and vehicle drivers are satisfactory, or if any improvements could be suggested;
- (5) making observations on a regular basis in different weather and light conditions to assess whether all runway entrances and visual aids are adequate, correctly located and understandable by all parties concerned, with no possible ambiguity of their meaning, or identify potential aerodrome design issues;
- (6) understanding the operating difficulties of personnel working in other areas, and recommending areas for improvement; when reviewing operating procedures it is necessary to ensure that the procedures employed by different companies at the aerodrome are integrated and effective, so as to minimise the risk of runway incursions. Care should be taken when examining existing or proposed runway capacity enhancing procedures or noise abatement schemes involving runway preferential systems;

- (7) development of joint, initial and recurrent, training programmes and familiarisation on runway incursion and excursion prevention, for all relevant personnel (vehicle drivers and other personnel operating on the manoeuvring area, pilots, Air Traffic Services personnel) ; this may include visits to the manoeuvring area to increase awareness of the aerodrome layout, markings, signs, position of anemometers etc., where this is considered necessary;
- (8) providing advice prior to the implementation of changes to the aerodrome, practices and procedures to identify potential for runway incursion or excursion; and
- (9) assessing the effectiveness of implemented operational solutions periodically.

## AMC2 ADR.OR.D.027 Safety programmes

ED Decision 2014/012/R

### HOT SPOTS

Once hot spots have been identified at an aerodrome, suitable strategies should be implemented to remove the hazard and, when this is not immediately possible, to manage and mitigate the risk, including the publication of HOT SPOT charts in the Aeronautical Information Publication.

## GM3 ADR.OR.D.027 Safety programmes

ED Decision 2014/012/R

### HOT SPOTS

A hot spot is defined as ‘a location on an aerodrome movement area with a history, or potential risk of collision, or runway incursion, and where heightened attention by pilots/drivers is necessary.’

Strategies to manage and mitigate the risk from hot spots, depending on the case, may include, but are not limited to:

- (a) awareness campaigns;
- (b) additional visual aids (signs, markings, and lighting);
- (c) establishment of alternative routings;
- (d) introducing changes to the design of parts of the aerodrome; and
- (e) the mitigation of blind spots in the aerodrome control tower.

Aerodrome charts showing hot spots should be produced locally, checked regularly for accuracy, revised as needed, distributed locally, and published in the AIP. The criteria used to establish and chart a hot spot are contained in the PANS-ATM (Chapter 7) and Annex 4 — Aeronautical Charts (Chapters 13, 14 and 15).

Examples of how hot spots are shown on charts are provided in Figures 1, 2, and 3 below.

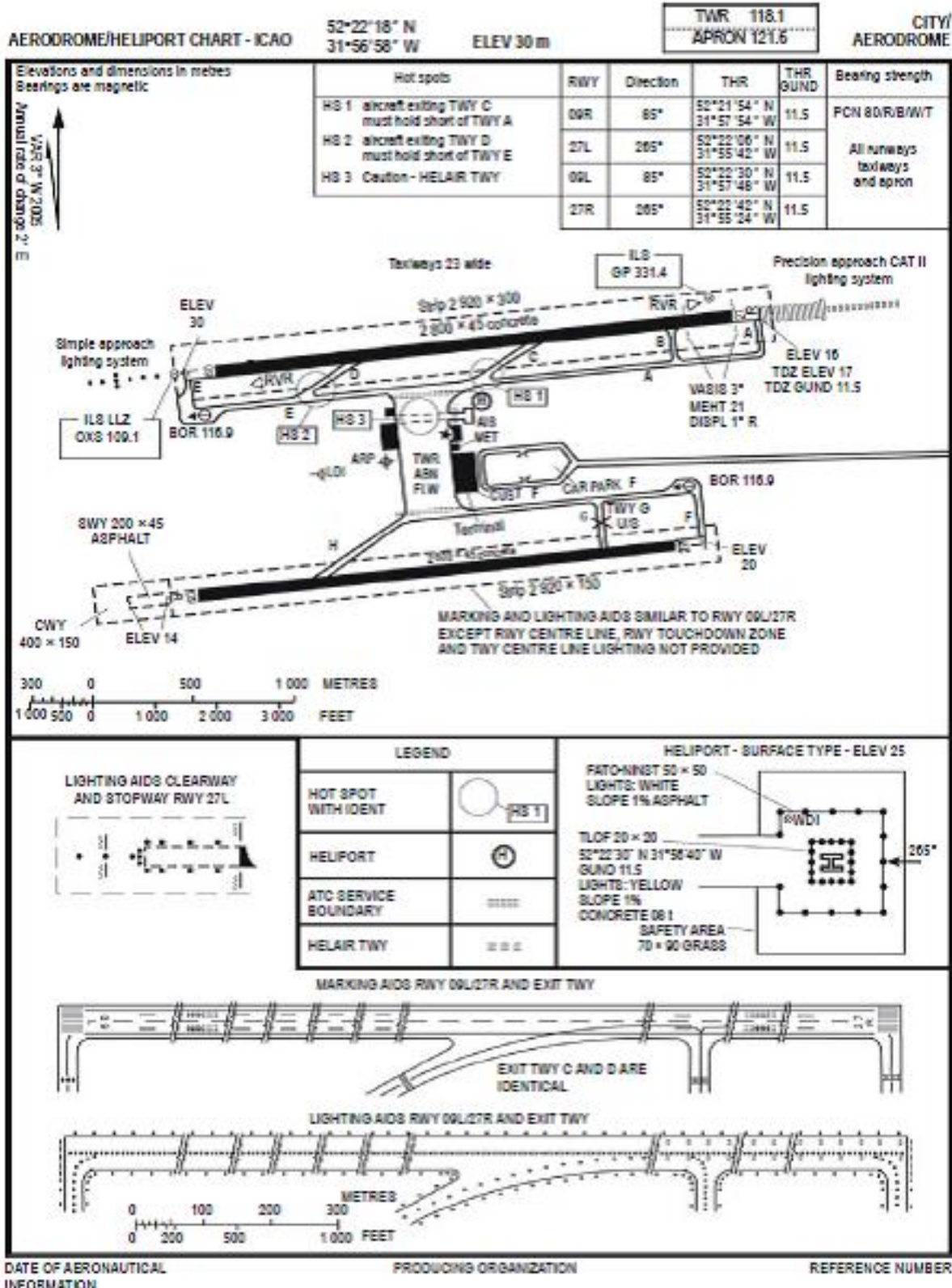


Figure 1

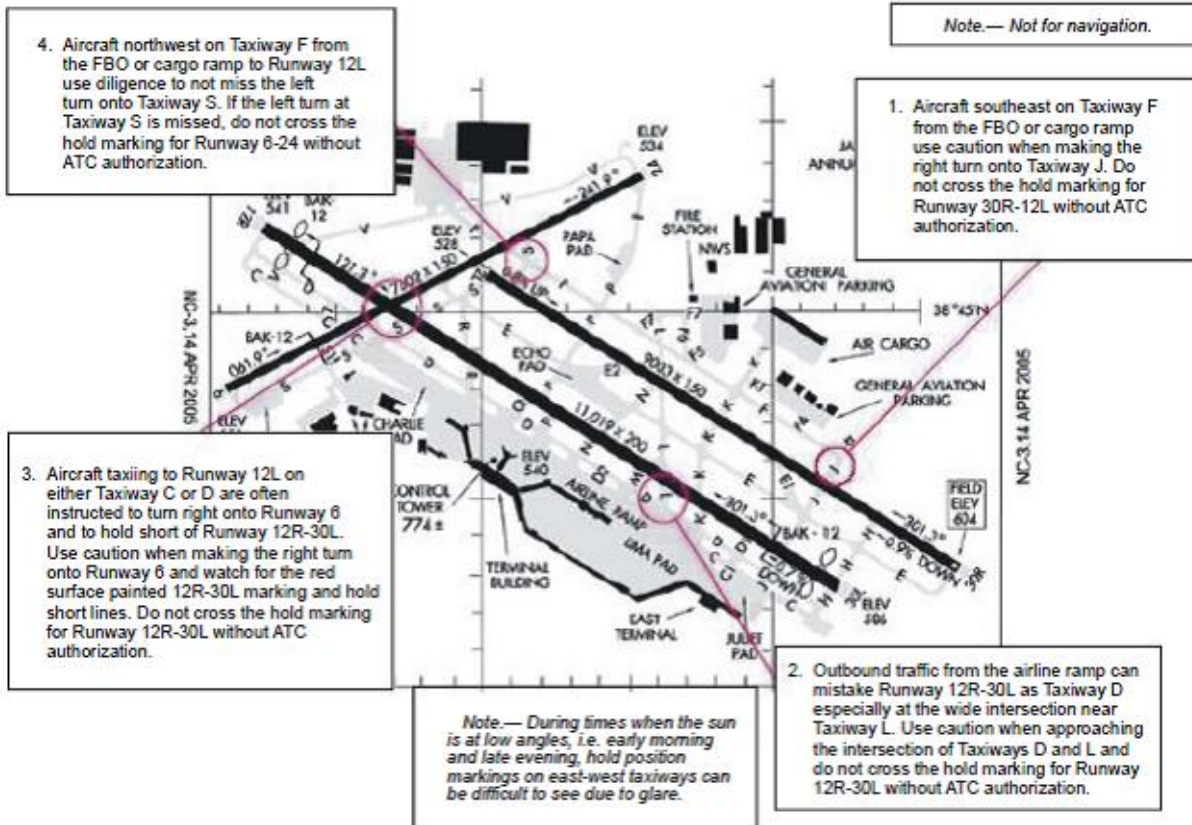
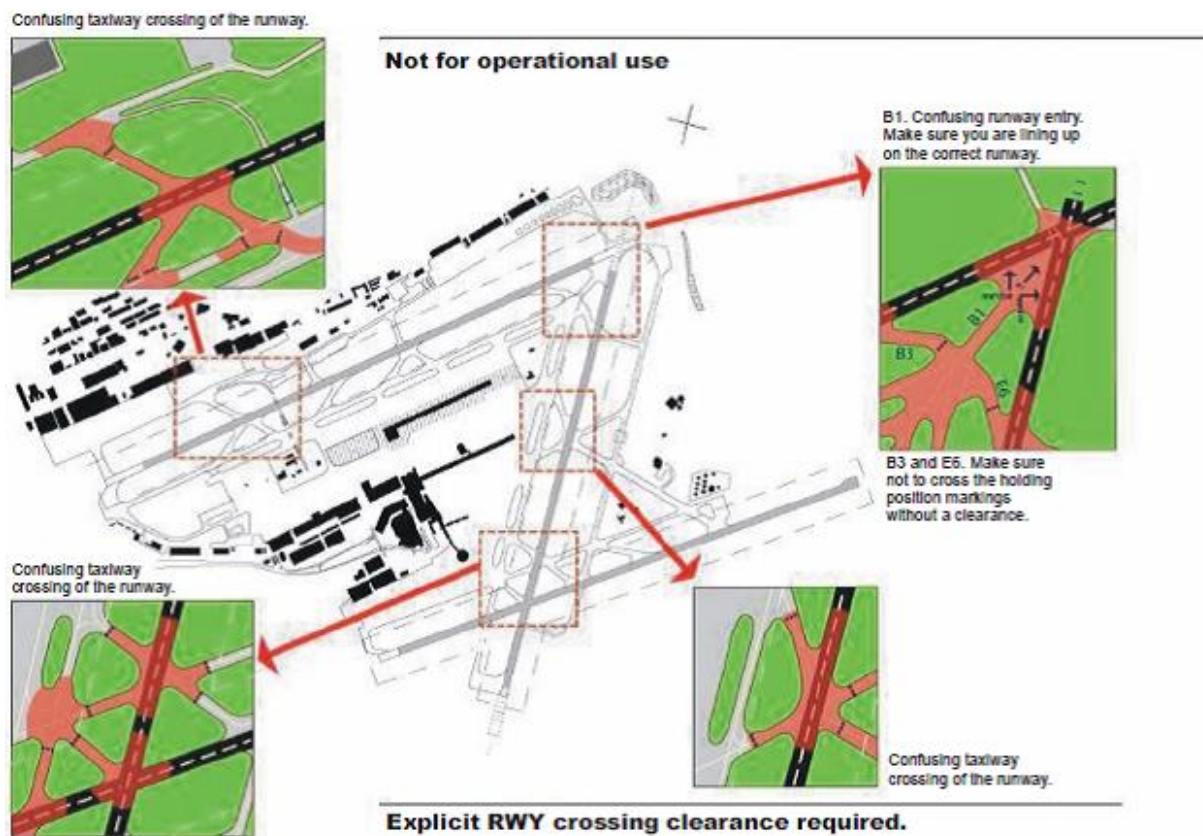


Figure 2


**Figure 3**

## ADR.OR.D.030 Safety reporting system

Regulation (EU) No 139/2014

- (a) The aerodrome operator shall establish and implement a safety reporting system for all personnel and organisations operating or providing services at the aerodrome, in order to promote safety at, and the safe use of, the aerodrome.
- (b) The aerodrome operator, in accordance with [ADR.OR.D.005\(b\)\(3\)](#), shall:
  - (1) require that the personnel and organisations mentioned in point (a) use the safety reporting system for the mandatory reporting of any accident, serious incident and occurrence; and
  - (2) ensure that the safety reporting system may be used for the voluntary reporting of any defect, fault and safety hazard which could impact safety.
- (c) The safety reporting system shall protect the identity of the reporter, encourage voluntary reporting and include the possibility that reports may be submitted anonymously.
- (d) The aerodrome operator shall:
  - (1) record all reports submitted;

- (2) analyse and assess the reports, as appropriate, in order to address safety deficiencies and identify trends;
- (3) ensure that all organisations operating or providing services at the aerodrome which are relevant to the safety concern, participate in the analysis of such reports and that any corrective and/or preventive measures identified are implemented;
- (4) conduct investigations of reports, as appropriate; and
- (5) refrain from attribution of blame in line with the ‘just culture’ principles.

## AMC1 ADR.OR.D.030 Safety reporting system

*ED Decision 2014/012/R*

### SAFETY REPORTING SYSTEM

#### (a) Safety reporting system — General

- (1) An effective safety reporting system should include, apart from aerodrome operator’s personnel, aircraft operators, ground handling service providers, air navigation service providers, and any other organisation operating on the aerodrome, or providing services at the aerodrome.
- (2) The safety reporting system should include voluntary reporting possibilities intended for safety hazards identified by the reporter, and that may have potential safety consequences.
- (3) The aerodrome operator should identify which events are mandatory to be reported.
- (4) The aerodrome operator should provide the means and the format for reporting which should be such that meets the existing reporting requirements foreseen in the applicable legislation in terms of time, format, and required information to be reported.
- (5) The safety reporting system should include an acknowledgement to the reporter for the submission of the report.
- (6) The reporting process should be as simple as possible, and well documented, including details as to what, how, where, whom, and when to report;
- (7) Regardless of the source or method of submission, once the information is received, it should be stored in a manner suitable for easy retrieval and analysis;
- (8) Access to the submitted reports should be restricted to persons responsible for storing and analysing them;
- (9) Protection of the identity of the reporter should be ensured, and the procedures established by the aerodrome operator to gather additional information for analyses, or investigations should respect this principle;
- (10) The safety reporting system should include a feedback system to the reporting person, on the outcome of the occurrence analysis.

#### (b) Wildlife hazard reporting



- (1) The aerodrome operator should ensure that its safety reporting system specifically addresses the requirement for all third parties (aircraft operators, aircraft mechanics, air traffic controllers, and other Air Traffic Services personnel, etc.) and all aerodrome personnel, to report to the aerodrome operator wildlife strikes, and relevant identified hazards.
- (2) The reporting of such third parties should be done irrespectively of any other requirements according to which they have to report to the Competent Authority of the aerodrome, or the state of registry of the aircraft involved, or any other Competent Authority in the context of the national occurrence reporting programme.

## GM1 ADR.OR.D.030 Safety reporting system

*ED Decision 2014/012/R*

### NEED FOR SAFETY REPORTING

- (a) The overall purpose of the safety reporting system is to use reported information to improve the level of safety performance of the aerodrome, and not to attribute blame.
- (b) The objectives of the safety reporting system should be:
  - (1) to enable an assessment to be made of the safety implications of each relevant occurrence, serious incident and accident, including previous similar events, so that any necessary action can be initiated; and
  - (2) to ensure that knowledge of relevant occurrences, serious incidents and accidents is disseminated, so that other persons and organisations may learn from them.

## ADR.OR.D.035 Record keeping

*Delegated Regulation (EU) 2020/2148*

- (a) The aerodrome operator shall establish an adequate system of record keeping, covering all its activities undertaken under Regulation (EC) No 216/2008 and its Implementing Rules.
- (b) The format of the records shall be specified in the aerodrome manual.
- (c) Records shall be stored in a manner that ensures protection from damage, alteration and theft.
- (d) Records shall be kept for a minimum of five years, except that the below records shall be kept as follows:
  - (1) the aerodrome certification basis, the alternative means of compliance in use and the current aerodrome or aerodrome operator certificate(s), for the lifespan of the certificate;
  - (2) arrangements with other organisations, for as long as such arrangements are in effect;
  - (3) manuals of aerodrome equipment or systems employed at the aerodrome, for as long as they are used at the aerodrome;
  - (4) safety assessment reports for the lifetime of the system/procedure/activity;

- (5) personnel training, qualifications, and medical records as well as their proficiency checks, as appropriate, for at least four years after the end of their employment, or until the area of their employment has been audited by the Competent Authority; and
  - (6) the current version of the hazard register;
  - (7) driving authorisations and, if appropriate, language proficiency certificates, for at least four years after the end of a person's employment, or the revocation or cancellation of a driving authorisation, or until this area of activity has been audited by the competent authority;
  - (8) vehicle authorisations and aerodrome operator's vehicle maintenance records, for at least four years after a vehicle is removed from operations, or until this area has been audited by the competent authority.
- (e) All records shall be subject to applicable data protection law.

## AMC1 ADR.OR.D.035 Record keeping

ED Decision 2014/012/R

### DOCUMENTATION TO BE RETAINED

- (a) The system employed by the aerodrome operator for record keeping should provide for adequate procedures, storage facilities, and reliable traceability, retrievability and accessibility of the records related to the activities of the aerodrome operator that are subject to the Basic Regulation and its Implementing Rules, throughout the required retention period.
- (b) Records should be kept in paper form, or in electronic format, or a combination of both. Records stored on microfilm or optical disc format are also acceptable. The records should remain legible throughout the required retention period. The retention period starts when the record has been created or last amended.
- (c) Paper systems should use robust material which can withstand normal handling and filing. Computer systems should have at least one backup system which should be updated within 24 hours of any new entry. Computer systems should include safeguards against the ability of unauthorised personnel to alter the data.
- (d) All computer hardware used to ensure data backup should be stored in a different location from that containing the working data, and in an environment that ensures they remain in good condition. When hardware or software changes take place, special care should be taken that all necessary data continues to be accessible, at least, through the full retention period. In the absence of any indication, all records should be kept for a minimum period of five years.

## AMC2 ADR.OR.D.035 Record keeping

ED Decision 2014/012/R

### RECORDING OF AIRCRAFT MOVEMENTS

- (a) The aerodrome operator should employ a system to be used for recording the aircraft movements at the aerodrome.
- (b) Such a system should allow the aerodrome operator to record:

- 
- (1) the number of movements of each aircraft type using the aerodrome;
  - (2) the type of each aircraft movement (commercial air transportation, cargo, etc.);
  - (3) the date of each movement; and
  - (4) the number of passengers.
- (c) The system used should also satisfy the provisions of [AMC1 ADR.OR.D.035](#).

## GM1 ADR.OR.D.035(b) Record keeping

ED Decision 2014/012/R

### RECORDS

Microfilming or optical storage of records may be carried out at any time. The records should be as legible as the original record, and remain so for the required retention period.

## SUBPART E — AERODROME MANUAL AND DOCUMENTATION (ADR.OR.E)

### ADR.OR.E.005 Aerodrome manual

Regulation (EU) No 139/2014

- (a) The aerodrome operator shall establish and maintain an aerodrome manual.
- (b) The content of the aerodrome manual shall reflect the certification basis and the requirements set out in this Part and [Part-ADR.OPS](#), as applicable, and shall not contravene the terms of the certificate. The aerodrome manual shall contain or refer to all necessary information for the safe use, operation and maintenance of the aerodrome, its equipment, as well as its obstacle limitation and protection surfaces and other areas associated with the aerodrome.
- (c) The aerodrome manual may be issued in separate parts.
- (d) The aerodrome operator shall ensure that all aerodrome personnel and all other relevant organisation's personnel have easy access to the portions of the aerodrome manual that are relevant to their duties and responsibilities.
- (e) The aerodrome operator shall:
  - (1) supply the Competent Authority with the intended amendments and revisions of the aerodrome manual, for items requiring prior approval in accordance with [ADR.OR.B.040](#), in advance of the effective date and ensure that they do not become effective before obtaining the Competent Authority's approval; or
  - (2) supply the Competent Authority with the intended amendments and revisions of the aerodrome manual in advance of the effective date, if the proposed amendment or revision of the aerodrome manual requires only a notification to the Competent Authority in accordance with [ADR.OR.B.040\(d\)](#) and [ADR.OR.B.015\(b\)](#).
- (f) Notwithstanding point (e), when amendments or revisions are required in the interest of safety, they may be published and applied immediately, provided that any approval required has been applied for.
- (g) The aerodrome operator shall:
  - (1) review the content of the aerodrome manual, ensure that it is kept up to date and amended whenever necessary;
  - (2) incorporate all amendments and revisions required by the Competent Authority; and
  - (3) make all aerodrome personnel and other relevant organisations aware of the changes that are relevant to their duties and responsibilities.
- (h) The aerodrome operator shall ensure that any information taken from other approved documents, and any amendment thereof, is correctly reflected in the aerodrome manual. This does not prevent the aerodrome operator from publishing more conservative data and procedures in the aerodrome manual.
- (i) The aerodrome operator shall ensure that:
  - (1) the aerodrome manual is written in a language acceptable to the Competent Authority; and

- (2) all personnel are able to read and understand the language in which those parts of the aerodrome manual and other operational documents pertaining to their duties and responsibilities are written.
- (j) The aerodrome operator shall ensure that the aerodrome manual:
  - (1) is signed by the accountable manager of the aerodrome;
  - (2) is printed or is in electronic format and is easy to revise;
  - (3) has a system for version control management which is applied and made visible in the aerodrome manual; and
  - (4) observes human factors principles and is organised in a manner that facilitates its preparation, use and review.
- (k) The aerodrome operator shall keep at least one complete and current copy of the aerodrome manual at the aerodrome and make it available for inspection by the Competent Authority.
- (l) The content of the aerodrome manual shall be as follows:
  - (1) General;
  - (2) Aerodrome management system, qualification and training requirements;
  - (3) Particulars of the aerodrome site;
  - (4) Particulars of the aerodrome required to be reported to the Aeronautical Information Service; and
  - (5) Particulars of the operating procedures of the aerodrome, its equipment and safety measures.

## AMC1 ADR.OR.E.005 Aerodrome manual

*ED Decision 2014/012/R*

### GENERAL

- (a) The aerodrome manual may vary in detail according to the complexity of the operation, and the type of the aerodrome.
- (b) The aerodrome manual or parts of it may be presented in any form, including electronic form. In all cases, the accessibility, usability, and reliability should be assured.
- (c) The aerodrome manual should be such that:
  - (1) all parts of the manual are consistent and compatible in form and content;
  - (2) the manual can be readily amended; and
  - (3) the content and amendment status of the manual is controlled and clearly indicated.
- (d) The aerodrome manual should include a description of its amendment and revision process specifying:
  - (1) the person(s) who may approve amendments or revisions;
  - (2) the conditions for temporary revisions and/or immediate amendments, or revision required in the interest of safety; and

- (3) the methods by which all personnel and organisations are advised of changes to the aerodrome manual.
- (e) The aerodrome manual may contain parts of, or refer to other controlled documents, such as aerodrome equipment manual, which are available at the aerodrome for use by the personnel.

## GM1 ADR.OR.E.005 Aerodrome manual

*ED Decision 2014/012/R*

### **AERODROME MANUAL**

- (a) Form of the aerodrome manual

The aerodrome manual is a key document both for the aerodrome operator and the Competent Authority. The manual is the source document describing how the aerodrome infrastructure, facilities, and operational procedures will operate safely.

As well as the operational procedures, the Competent Authority will expect the aerodrome manual to be an accurate reflection of the day-to-day functioning of the aerodrome's safety management system, and its safety culture. It will need to show how the aerodrome intends to measure its performance against safety targets and objectives. The reader of an aerodrome manual should be given a clear statement of how safety is developed, managed, and maintained on the aerodrome. All safety policies, operational procedures and instructions should be contained in detail when relevant or cross-referenced to other controlled, formally accepted or recognised, publications.

At larger aerodromes, the size and complexity of operations, and related procedures may dictate that these procedures could not easily be included in a single document. In such circumstances, it is acceptable to identify and reference within the aerodrome manual the procedures which are not included within it. If this system is to be successful, it is essential that any referenced information, documentation, and procedures are made available as necessary to all operational staff in a similar way as the aerodrome manual itself. For that purpose, a computerised database containing the referenced procedures and information could be suitable. For many small aerodromes, the aerodrome manual can be both simple and brief as long as it covers procedures essential for satisfactory day-to-day operations. Nevertheless, it is possible to adopt a common format embracing the essential elements that define a safety management system.

- (b) Purpose of the aerodrome manual

An efficient management structure and a systematic approach to aerodrome operation is essential. The aerodrome manual should contain all the relevant information to describe this structure satisfactorily. It is one of the means by which all relevant operating staff can be informed as to their duties and responsibilities with regard to safety. It should describe the aerodrome infrastructure, services and facilities, all operating procedures, and any restrictions on aerodrome availability.

Accountability for safety must start at the very top of any organisation. One of the key elements in establishing safe working practices is the 'top down' approach where all staff should understand the safety aims of the organisation, the chain of command, and their own responsibilities and accountabilities. As safety management principles are applied, the aerodrome manual should be expanded to describe clearly how the safety of operations is to be managed. To a reader or user of the aerodrome manual, there should never be any doubt in terms of 'safety accountability' for each domain or activity described. Each section should

define who is accountable, who is responsible, who has the authority, who has the expertise, and who actually carries out the tasks described in any section.

The principle objective of an aerodrome manual should be to show how management will accomplish its safety responsibilities. The aerodrome manual will set out the policy and expected standards of performance, and the procedures by which they will be achieved.

The aerodrome operator should ensure that:

- (1) the responsibilities of the aerodrome operator are clearly described;
- (2) the tasks and activities that are to be performed by the aerodrome operator or its subcontractors are listed; and
- (3) the means and procedures in order to complete these tasks and activities are described or appended, together with the necessary details on their frequencies and operating modes.

Where responsibilities are attributed to other stakeholders, the aerodrome manual should clearly identify them.

## AMC2 ADR.OR.E.005(i)(2) Aerodrome manual

*ED Decision 2014/012/R*

### LANGUAGE OF THE AERODROME MANUAL

A translated version of the relevant parts of the aerodrome manual is an acceptable means to comply with the relevant requirement. In any case, the persons who are going to use the manual should be able to read and understand it.

## AMC3 ADR.OR.E.005 Aerodrome manual

*ED Decision 2021/003/R*

### AERODROME MANUAL

- (a) The aerodrome manual should have the following structure, and include, at least, the following information; if an item is not applicable, the indication 'Not applicable' or 'Intentionally blank' should be inserted, along with the relevant reason:
  - A. PART A — GENERAL
    0. Administration and control of the aerodrome manual including the following:
      - 0.1. Introduction:
        - 0.1.1 a statement signed by the accountable manager that the aerodrome manual complies with all applicable requirements, and with the terms of the certificate;
        - 0.1.2 a statement signed by the accountable manager that the aerodrome manual contains operational instructions that are to be complied with by the relevant personnel;
        - 0.1.3 a list and brief description of the various parts, their contents, applicability, and use;
        - 0.1.4 explanations, abbreviations, and definitions of terms needed for the use of the manual;

- 
- 0.2 System of amendment and revision:
- 0.2.1 details of the person(s) responsible for the issuance and insertion of amendments and revisions;
  - 0.2.2 a record of amendments and revisions with insertion dates, and effective dates;
  - 0.2.3 a statement that handwritten amendments and revisions are not permitted, except in situations requiring immediate amendment, or revision in the interest of safety;
  - 0.2.4 a description of the system for the annotation of pages, or paragraphs and their effective dates;
  - 0.2.5 a list of effective pages or paragraphs;
  - 0.2.6 annotation of changes (in the text and, as far as practicable, on charts and diagrams);
  - 0.2.7 temporary revisions; and
  - 0.2.8 description of the distribution system and a distribution list for the aerodrome manual, its amendments, and revisions.
1. General information
- General information including the following:
- 1.1 purpose and scope of the aerodrome manual;
  - 1.2 legal requirements for an aerodrome certificate and the aerodrome manual as prescribed in [Part-ADR.OR](#);
  - 1.3 conditions for use of the aerodrome by its users;
  - 1.4 the obligations of the aerodrome operator; rights of the Competent Authority and guidance to staff on how to facilitate audits/inspections by Competent Authority personnel.
- B. PART B — AERODROME MANAGEMENT SYSTEM, QUALIFICATION AND TRAINING REQUIREMENTS
2. A description of the management system, including the following:
- 2.1 Aerodrome organisation and responsibilities including the following: a description of the organisational structure, including the general organogram and other departments' organograms. The organogram should depict the relationship between the departments. Subordination and reporting lines of all levels of organisational structure (Departments, Sections, etc.) related to safety should be shown.  
  
Names, authorities, responsibilities, and duties of management and nominated persons; responsibilities and duties of other operational, maintenance personnel, as well of the aerodrome safety committees and the Local Runway Safety Team and their functioning, should also be included.
  - 2.2. A description of the safety management system, including:
    - 2.2.1 scope of the safety management system;



- 
- 2.2.2 safety policy and objectives;
  - 2.2.3 safety responsibilities of key safety personnel;
  - 2.2.4 documentation control procedures;
  - 2.2.5 safety risk management process, including hazard identification and risk assessment schemes;
  - 2.2.6 monitoring of implementation and effectiveness of safety actions, and risk mitigation measures;
  - 2.2.7 safety performance monitoring;
  - 2.2.8 safety reporting (including hazard reporting) and investigation;
  - 2.2.9 emergency response planning;
  - 2.2.10 management of change (including organisational changes with regard to safety responsibilities);
  - 2.2.11 safety promotion; and
  - 2.2.12 safety management system outputs.
- 2.3 A description of the compliance monitoring and related procedures.
  - 2.4 A description of the quality management system for aeronautical data and aeronautical information provision activities and related procedures, including those for meeting the relevant safety, and security management objectives.
  - 2.5 Procedures for reporting to the Competent Authority including handling, notifying and reporting accidents, serious incidents, and occurrences. This section should include, at least, the following:
    - (a) definition of accident, serious incident and occurrence and of the relevant responsibilities of all persons involved;
    - (b) illustrations of forms to be used (or copies of the forms themselves), instructions on how they are to be completed, the addresses to which they should be sent and the time allowed for this to be done;
    - (c) procedures and arrangements for the preservation of evidence, including recordings, following a reportable event;
  - 2.6 Procedures related to the use of alcohol, psychoactive substances and medicines.
  - 2.7 Procedures for:
    - 2.7.1 complying with safety directives;
    - 2.7.2 reaction to safety problems; and
    - 2.7.3 handling of safety recommendations issued by Safety Investigation Authorities.
  - 2.8 A description of the method and procedures for recording aircraft movements, including movement and aircraft type, dates, and number of passengers.
- 3. Required aerodrome personnel qualifications (see [GM1 ADR.OR.D.015\(d\)](#)). Moreover, procedures related to:

- 
- 3.1 the training programme, including the following:
    - 3.1.1 responsibilities, frequencies, syllabi, duration of each type of training, method for delivery of training and competency assessment, minimum performance to be achieved by the trainees, and the identified training standards for all personnel involved in the operation, rescue and firefighting maintenance and management of the aerodrome, and those persons operating unescorted on the movement area and other operational areas of the aerodrome.
    - 3.1.2 procedures:
      - 3.1.2.1 for training and competency assessment of the trainees;
      - 3.1.2.2 to be applied in the event that personnel do not achieve the required standards.
    - 3.1.3 description of documentation to be stored and storage periods.
  - 3.2 the proficiency check programme, including responsibilities and frequencies of proficiency checks;
    - 3.2.1 checking methods and procedures.
    - 3.2.2 procedures to be applied in the event that personnel do not achieve the required standards.
    - 3.2.3 the validation process to measure the effectiveness of the programme.
    - 3.2.4 description of documentation to be stored and storage periods.
  - C. PART C — PARTICULARS OF THE AERODROME SITE
  - 4. A description of the aerodrome site including in particular, the following information:
    - 4.1 a plan showing the distance of the aerodrome from the nearest city, town, or other populous area;
    - 4.2 detailed maps and charts of the aerodrome showing the aerodrome's location (longitude and latitude) and boundaries, major facilities, aerodrome reference point, layout of runways, taxiways and aprons, aerodrome visual and non-visual aids, and wind direction indicators;
    - 4.3 a plan showing the location of any aerodrome facilities and equipment outside the boundaries of the aerodrome;
    - 4.4 description of the physical characteristics of the aerodrome, elevations, visual and non-visual aids, as well as the information regarding the aerodrome reference temperature, strength of pavements, rescue and firefighting level of protection, ground aids and main obstacles;
    - 4.5 description of any cases of exemptions or derogations, equivalent level of safety, special conditions, and operating limitations; and
    - 4.6 description of the types of operations that the aerodrome is approved to conduct.
  - D. PART D — PARTICULARS OF THE AERODROME REQUIRED TO BE REPORTED TO THE AERONAUTICAL INFORMATION SERVICE

5. The aeronautical information services available and the procedures for the promulgation of general information, including the following:
  - 5.1 the name of the aerodrome;
  - 5.2 the location of the aerodrome;
  - 5.3 the geographical coordinates of the aerodrome reference point determined in terms of the World Geodetic System — 1984 (WGS-84) reference datum;
  - 5.4 the aerodrome elevation and geoid undulation;
  - 5.5 the elevation of each threshold and geoid undulation, the elevation of the runway end, and any significant high and low points along the runway, and the highest elevation of the touchdown zone of a precision approach runway;
  - 5.6 the aerodrome reference temperature;
  - 5.7 details of the aerodrome beacon; and
  - 5.8 the name of the aerodrome operator and contact details (including telephone numbers) of the aerodrome operator at which may be contacted at all times.
6. Aerodrome dimensions and related information, including the following:
  - 6.1 runway — true bearing, designation number, length, width, displaced threshold location, slope, surface type, type of runway and, for a precision approach runway, the existence of an obstacle free zone;
  - 6.2 length, width and surface type of strip, runway end safety areas, stopways; length, width and surface type of taxiways; apron surface type and aircraft stands; clearway length and ground profile;
  - 6.3 visual aids for approach procedures, approach lighting type and visual approach slope indicator system; marking and lighting of runways, taxiways, and aprons; other visual guidance and control aids on taxiways and aprons, location and type of visual docking guidance system; availability of standby power for lighting;
  - 6.4 the location and radio frequency of VOR aerodrome checkpoints;
  - 6.5 the location and designation of standard taxi routes;
  - 6.6 the geographical coordinates of each threshold, appropriate taxiway centre line points, and aircraft stands;
  - 6.7 the geographical coordinates, and the top elevation of significant obstacles in the approach and take-off areas, in the circling area and in the surroundings of the aerodrome (in the form of charts);
  - 6.8 pavement surface type and bearing strength using the Aircraft Classification Number — Pavement Classification Number (ACN-PCN) method;
  - 6.9 pre-flight altimeter check locations established and their elevation;
  - 6.10 declared distances;
  - 6.11 contact details (telephone/telex/fax numbers and e-mail address) of the aerodrome coordinator for the removal of disabled aircraft, and information on the capability to remove disabled aircraft, expressed in terms of the largest aircraft type;

- 6.12 rescue and firefighting level of protection; types and amounts of extinguishing agents normally available at the aerodrome; and
- 6.13 exemptions or derogations from the applicable requirements, cases of equivalent level of safety, special conditions, and limitations.
- E. PART E — PARTICULARS OF OPERATING PROCEDURES OF THE AERODROME, ITS EQUIPMENT, AND SAFETY MEASURES
- 7. Aerodrome reporting, including:
  - 7.1 arrangements and procedures for reporting changes to the aerodrome information set out in the AIP and requesting the issue of NOTAM, including reporting changes to the Competent Authority and recording of the reporting of changes;
  - 7.2 procedures and frequencies for aeronautical data surveying, including areas to be surveyed.
- 8. Procedures for accessing the aerodrome movement area, including:
  - 8.1 coordination with the security agencies;
  - 8.2 prevention of unauthorised entry into the movement area;
- 9. Procedures for the inspection, assessment and reporting of the condition of the aerodrome movement area and other operational areas and facilities, (including runway surface friction characteristics assessments and water-depth measurements), including:
  - 9.1 arrangements and means of communicating with the air traffic services unit during inspections;
  - 9.2 inspection checklists, logbook, and record-keeping; and
  - 9.3 inspection intervals and times; reporting results and follow-up actions.
- 10. Procedures for the inspection, and routine and emergency maintenance of visual and non-visual aids, as appropriate, and the aerodrome electrical systems, including:
  - 10.1 inspection checklists, logbook, and record keeping; and
  - 10.2 inspection intervals and times; reporting results and follow-up actions.
- 11. Operating, maintenance and repair instructions, servicing information, troubleshooting and inspection procedures of aerodrome equipment.
- 12. Procedures for:
  - 12.1 maintenance of the movement area, including paved areas; unpaved runways and taxiways; runways and runway strips and aerodrome drainage;
  - 12.2 overload operations.
- 13. Procedures for aerodrome works, including:
  - 13.1 coordinating, planning, and carrying out construction and maintenance work; and
  - 13.2 arrangements and means of communicating with air traffic services unit during the progress of such work.
- 14. Procedures for apron management, including:

- 14.1 transfer of the aircraft between air traffic services unit, and the apron management unit;
- 14.2 allocation of aircraft parking positions;
- 14.3 engine start and aircraft push-back; and
- 14.4 marshalling and 'follow-me' service.
15. Procedures for apron safety management, including:
  - 15.1 protection from jet blasts and downwash;
  - 15.2 enforcement of safety precautions during aircraft refuelling operations;
  - 15.3 FOD prevention, including apron cleaning/sweeping;
  - 15.4 monitoring compliance of personnel on the apron with safety procedures; and
  - 15.5 escorting, controlling and protecting passengers on the apron, from vehicular traffic and operating aircraft, use of predetermined routes, and avoiding interference with stationary aircraft ground servicing activities.
16. Procedures for the control and limitation of the number of vehicles operating on the movement area, issuance of authorisations and temporary permits of vehicles operating on or in the vicinity of the movement area, including driver's obligations, traffic rules, right of way, speed limits, and procedures for issuing driving authorisations and permits, and enforcement procedures. Procedures for escorting vehicles occasionally used in areas where radio and transponder or equivalent is required, as well as for vehicles temporarily permitted to operate on the movement area. Procedures and responsibilities for establishing and monitoring the implementation of the maintenance programme for vehicles operating on the movement area and other operating areas.
17. Procedures for wildlife hazard management, including assessing wildlife hazards and arrangements for implementation of the wildlife control programme, and promulgation of the relevant information to the AIS; wildlife strike form.
18. Procedures for:
  - 18.1 obstacle control and monitoring within and outside of the aerodrome boundaries, and notification to the Competent Authority, of the nature and location of obstacles, and any subsequent addition, or removal of obstacles for action as necessary, including amendment of the AIS publications; and
  - 18.2 monitoring and mitigating hazards related to human activities and land use, on the aerodrome and its surroundings.Relevant inspection checklists, logbook, and record keeping; inspection intervals and times; reporting results and follow-up actions.
19. Aerodrome emergency plan including:
  - 19.1 dealing with emergencies at the aerodrome or in its surroundings;
  - 19.2 tests for aerodrome facilities and equipment to be used in emergencies, including their frequency; and
  - 19.3 exercises to test emergency plans, including their frequency.

20. Rescue and firefighting, including description of facilities, equipment, personnel and procedures for meeting the firefighting requirements.
  21. Removal plan of disabled aircraft, including relevant arrangements, equipment, and procedures for its implementation.
  22. Procedures for ensuring the safe handling and storage of fuel and dangerous goods in the aerodrome, including:
    - 22.1 equipment, storage areas, delivery, dispensing, handling, and safety measures;
    - 22.2 quality and correct specification of aviation fuel; audit and inspection intervals, checklists, sampling and record keeping.
  23. Low visibility operations: description of operational procedures, including coordination with air traffic services unit and apron management unit, standard taxiing routes, control of activities, and measurement and reporting of runway visual range.
  24. Procedures for winter operations, including snow removal plan and procedures for its implementation as well as description of the available means and relevant arrangements.
  25. Procedures for operations in adverse weather conditions.
  26. Procedures for night operations.
  27. Procedures for the protection of radar and other navigational aids, control of activities, and ground maintenance in the vicinity of these installations.
  28. Procedures for the operation of aircraft with higher code letter at the aerodrome, including taxiing routes.
  29. Procedures and measures for the prevention of fire at the aerodrome.
  30. Communication procedures, including: frequencies; language and phraseology to be used when communicating with the air traffic services; vehicle call signs; communication signals to be used in case of radio communication failure; communication via the air traffic services provider; and dissemination of significant information.
  31. Aircraft towing procedures, including: designated routes to be used; lights to be displayed by aircraft; communication procedures; guidance to be provided; measures for ensuring safety of towing operation in adverse weather conditions, including visibility and weather phenomena in which towing is limited or not permitted.
  32. Procedures for the handover of activities between aerodrome personnel, including description of the system for the provision of operational information to other organisations operating at the aerodrome.
- (b) All procedures contained in the aerodrome manual should include and clearly define the roles, responsibilities, and contact details of responsible aerodrome personnel, other persons or organisations, including the contracted ones, including the Competent Authority and other state agencies involved, as appropriate, and take into account the need for establishing direct communication during non-working hours.

## GM2 ADR.OR.E.005 Aerodrome manual

*ED Decision 2014/012/R*

### CONTENTS

The numbering system described in [AMC3 ADR.OR.E.005](#) should be maintained even if there are sections that, because of the nature of the aerodrome or the types of operation, are not applicable.

## GM1 ADR.OR.E.005(j) Aerodrome manual

*ED Decision 2014/012/R*

### HUMAN FACTORS PRINCIPLES

Guidance material on the application of human factors principles may be found in the ICAO Human Factors Training Manual (Doc 9683).

## ADR.OR.E.010 Documentation requirements

*Regulation (EU) No 139/2014*

- (a) The aerodrome operator shall ensure the availability of any other documentation required and associated amendments.
- (b) The aerodrome operator shall be capable of distributing operational instructions and other information without delay.

## SUBPART F — APRON MANAGEMENT SERVICE (ADR.OR.F)

### ADR.OR.F.001 Responsibilities of the organisation responsible for the provision of AMS

*Delegated Regulation 2020/1234*

The organisation responsible for the provision of AMS shall provide the apron management service in accordance with:

- (a) the requirements set out in Annex VII to [Regulation \(EU\) 2018/1139](#) and in [Annex III](#) (Part-ADR.OR) and [Annex IV](#) (Part-ADR.OPS) to this Regulation;
- (b) its declaration;
- (c) the operating procedures included in the aerodrome manual;
- (d) its management system manual in accordance with [ADR.OR.F.095](#);
- (e) any other manuals used for the provision of apron management service.

*[applicable from 20 March 2022]*

### ADR.OR.F.005 Declaration of the organisation responsible for the provision of AMS

*Delegated Regulation (EU) 2020/1234*

- (a) When an organisation responsible for the provision of AMS intends to provide guidance to aircraft as laid down in points a(1) and a(2) of point [ADR.OPS.D.001](#) as a minimum, it shall submit a declaration to the Competent Authority at least 2 months before the date of the intended start of the provision of the service. The declaration shall contain the following information:
  - (1) the name of the organisation responsible for the provision of AMS;
  - (2) contact details of the organisation responsible for the provision of AMS;
  - (3) name and contact details of the accountable manager;
  - (4) the name(s) of the aerodrome(s) in the Member State where the service will be provided;
  - (5) a list of aerodromes located in other Member States where the service is provided;
  - (6) the date of the intended start of the provision of the apron management service;
  - (7) a statement that confirms that it has established formal arrangements with the aerodrome operator and the air traffic service provider at the aerodrome where it intends to provide the apron management service;
  - (8) a statement that confirms that the organisation responsible for the provision of AMS has developed a safety policy and will apply that policy during the provision of the service covered by the declaration, in accordance with point [ADR.OR.F.045\(b\)\(2\)](#);
  - (9) a statement that confirms that the organisation responsible for the provision of AMS complies and will, during the provision of the service covered by the declaration, continue to comply with the applicable requirements of Annex VII to [Regulation \(EU\) 2018/1139](#) and [Annex III](#) (Part-ADR.OR) and [Annex IV](#) (Part-ADR.OPS) to this Regulation;



- (b) By derogation from point (a), when a certified aerodrome operator or an approved air traffic services provider intends to provide apron management service, it shall:
- (1) notify its Competent Authority;
  - (2) revise its safety policy to include the provision of apron management service;
  - (3) submit to the Competent Authority the training programme of the personnel intended to be used for the provision of the service.

*[applicable from 20 March 2022]*

## GM1 ADR.OR.F.005(a) Declaration of the organisation responsible for the provision of AMS

*ED Decision 2020/021/R*

### RESPONSIBILITY OF THE ORGANISATION RESPONSIBLE FOR THE PROVISION OF AMS AS REGARDS THE SUCCESSFUL SUBMISSION OF THE DECLARATION

It is the responsibility of the organisation responsible for the provision of AMS to successfully submit the declaration to the Competent Authority. If the organisation responsible for the provision of AMS does not receive an acknowledgement of receipt of the declaration by the Competent Authority under point ADR.AR.C.050 within a reasonable period of time following the submission of the declaration, it contacts the Competent Authority to investigate whether or not the submission of the declaration has been successful.

*[applicable from 20 March 2022]*

## GM2 ADR.OR.F.005(a) Declaration of the organisation responsible for the provision of AMS

*ED Decision 2020/021/R*

### DECLARATION OF COMPLIANCE MODEL FORM FOR ORGANISATIONS RESPONSIBLE FOR THE PROVISION OF AMS

<p><b>Declaration of compliance</b></p> <p><b>for organisations responsible for the provision of AMS</b></p> <p>In accordance with <a href="#">Commission Regulation (EU) No 139/2014</a> of 14 February 2014 laying down requirements and procedures related to aerodromes pursuant to Regulation (EC) No 216/2008 of the European Parliament and of the Council</p>
Company name and postal address:
Name and contact details of the accountable manager of the organisation:
Aerodrome(s) in the Member State at which apron management services (AMS) are provided:
Aerodrome(s) in other Member State(s) at which apron management services (AMS) are provided:
Starting date of the provision of apron management services at the aerodrome:
Formal arrangements have been made between the aerodrome operator and the air traffic services (ATS) provider.

A safety policy has been established and will apply during the provision of apron management services (AMS) covered by the declaration, in accordance with point [ADR.OR.F.045\(b\)\(2\)](#) of [Annex III](#) (Part-ADR.OR) to [Commission Regulation \(EU\) No 139/2014](#).

The apron management services (AMS) covered by the declaration comply and will continue to comply, during the period they are provided, with the applicable requirements of Annex VII to [Regulation \(EU\) 2018/1139](#) and [Annex III](#) (Part-ADR.OR) and [Annex IV](#) (Part-ADR.OPS) to [Commission Regulation \(EU\) No 139/2014](#).

Any change in the provision of apron management services which affects the information stated in this declaration will be notified to the Competent Authority.

I hereby confirm that the information stated in this declaration is correct.

Date

Signature of the accountable manager

*[applicable from 20 March 2022]*

## ADR.OR.F.010 Continued validity of the declaration

*Delegated Regulation (EU) 2020/1234*

A declaration made by an organisation responsible for the provision of AMS in accordance with point [ADR.OR.F.005](#) shall remain valid subject to the following conditions:

- (a) the organisation responsible for the provision of AMS is compliant with the requirements set out in Annex VII to [Regulation \(EU\) 2018/1139](#) and in [Annex III](#) (Part-ADR.OR) and [Annex IV](#) (Part-ADR.OPS) to this Regulation, taking into account the provisions related to the handling of findings as specified under point [ADR.OR.F.035](#) of this Annex;
- (b) the Competent Authority is granted access to the organisation responsible for the provision of AMS in accordance with point [ADR.OR.F.030](#) of this Annex to determine continued compliance with the requirements set out in Annex VII to [Regulation \(EU\) 2018/1139](#) and in [Annex III](#) (Part-ADR.OR) and [Annex IV](#) (Part-ADR.OPS) to this Regulation;
- (c) the declaration has not been withdrawn by the organisation responsible for the provision of AMS or been notified by the Competent Authority to cease some or all services covered by the declaration.

*[applicable from 20 March 2022]*

## ADR.OR.F.015 Start of the provision of apron management service

*Delegated Regulation (EU) 2020/1234*

An organisation responsible for the provision of AMS shall start the provision of apron management service at an aerodrome, when:

- (a) the declaration has been received by the Competent Authority;
- (b) it has established formal arrangements with the certified aerodrome operator and the approved air traffic service provider at the aerodrome where the service will be provided in accordance with points [ADR.OR.F.085](#) and [ADR.OR.F.090](#) respectively;

- (c) it provides evidence that its personnel have completed the required initial and unit training.  
*[applicable from 20 March 2022]*

## ADR.OR.F.020 Termination of the provision of apron management service

*Delegated Regulation (EU) 2020/1234*

An organisation responsible for the provision of AMS that intends to terminate permanently the provision of the service at an aerodrome shall:

- (a) notify the aerodrome operator and the Competent Authority, as soon as possible, so as to enable appropriate measures to be taken for the safe continuation of the service;
- (b) submit to the Competent Authority an amended declaration or request de-registration of the declaration, upon the date of termination of the provision of the service.

*[applicable from 20 March 2022]*

## AMC1 ADR.OR.F.020(a) Termination of the provision of apron management services (AMS)

*ED Decision 2020/021/R*

### NOTIFICATION

When the organisation responsible for the provision of AMS intends to terminate the provision of such services, it should notify in writing the Competent Authority and the aerodrome operator. The prior notice for the notification should be such so as to enable appropriate measures to be taken for the continuation of the service, if necessary, and to allow for the timely publication of the changes and their notification by the Aeronautical Information Regulation and Control (AIRAC) system in accordance with the required time frame.

*[applicable from 20 March 2022]*

## ADR.OR.F.025 Changes

*Delegated Regulation (EU) 2020/1234*

- (a) The organisation responsible for the provision of AMS shall coordinate with the aerodrome operator any changes to the information contained in the declaration specified in point [ADR.OR.F.005\(a\)](#) and to the training programme or the management system manual respectively referred to in point [ADR.OR.F.005\(b\)](#) and point [ADR.OR.F.095](#).
- (b) The organisation responsible for the provision of AMS shall notify without undue delay the Competent Authority of any changes specified in point (a) and, if necessary, submit an amended declaration.
- (c) The organisation responsible for the provision of AMS shall provide the Competent Authority with the relevant documentation in accordance with point (d).
- (d) As part of its management system referred to in point [ADR.OR.F.045](#), the organisation responsible for the provision of AMS that proposes a change to its organisation, its management system or its training programme shall:

- (1) determine the interdependences with any affected parties, and plan and conduct a safety assessment in coordination with these organisations;
- (2) align assumptions and mitigations with any affected parties in a systematic way;
- (3) ensure a comprehensive assessment of the change including any necessary interactions;
- (4) ensure that complete and valid arguments, evidence and safety criteria are established and documented to support the safety assessment, and that the change supports the improvement of safety whenever reasonably practicable.

[applicable from 20 March 2022]

## GM1 ADR.OR.F.025(d) Changes

ED Decision 2020/021/R

### ASSESSMENT OF CHANGES

(a) Safety (risk) assessment of a change

A safety (risk) assessment of a change includes:

- (1) the identification of the scope of the change;
- (2) the identification of hazards;
- (3) the determination of the safety criteria applicable to the change;
- (4) the risk assessment in relation to the harmful effects or improvements in safety related to the change and, if required, risk mitigation for the change to meet the applicable safety criteria;
- (5) the verification that the change conforms to the scope that was subject to the safety assessment, and that it meets the safety criteria, before the change is put into operation; and
- (6) the specification of the monitoring requirements necessary to ensure that the aerodrome and its operation will continue to meet the safety criteria after the change has been put into operation.

(b) Scope of the safety assessment

The scope of the safety assessment includes the following elements and their interaction:

- (1) the aerodrome, its operation, management, and human resources being changed;
- (2) the interfaces and interactions between the elements being changed and the rest of the system;
- (3) the interfaces and interactions between the elements being changed and the environment in which they are intended to operate; and
- (4) the full lifecycle of the change from conception to operations.

(c) Safety criteria

The safety criteria used for the safety assessment of a change:

- (1) are compatible or the same with the safety criteria of the aerodrome operator and the air traffic services (ATS) provider;

- (2) are defined in accordance with the procedures for the management of the change contained in the management system manual; and
- (3) depending on the availability of data, are specified with reference to explicit quantitative acceptable safety risk levels, recognised standards and/or codes of practice, the safety performance of the existing or a similar system.

*[applicable from 20 March 2022]*

## ADR.OR.F.030 Access

*Delegated Regulation (EU) 2020/1234*

For the purpose of determining whether an organisation responsible for the provision of AMS is acting in accordance with its declaration, the organisation responsible for the provision of AMS shall ensure that any person duly authorised by the Competent Authority, at any time:

- (a) is granted access to any facility, document, records, data, procedures or any other material relevant to its activity;
- (b) is allowed to perform or witness any action, inspection, test, assessment or exercise the Competent Authority finds necessary.

*[applicable from 20 March 2022]*

## ADR.OR.F.035 Findings and corrective actions

*Delegated Regulation (EU) 2020/1234*

- (a) After the Competent Authority has communicated a finding to an organisation responsible for the provision of AMS in accordance with point [ADR.AR.C.055](#) of Annex II, the organisation responsible for the provision of AMS shall take the following steps within the time period determined by the Competent Authority:
  - (1) identify the root cause of the non-compliance;
  - (2) define a corrective action plan;
  - (3) demonstrate the corrective action implementation to the satisfaction of the Competent Authority within the time period agreed with that authority in accordance with point [ADR.AR.C.055\(d\)](#) of Annex II.
- (b) The organisation responsible for the provision of AMS shall inform the aerodrome operator of the actions detailed in point (a) and, where appropriate, coordinate such actions with the aerodrome operator.

*[applicable from 20 March 2022]*

## ADR.OR.F.040 Immediate reaction to a safety problem — compliance with safety directives

*Delegated Regulation (EU) 2020/1234*

An organisation responsible for the provision of AMS shall:

- (a) implement any safety measures, including safety directives, taken by the Competent Authority in accordance with points [ADR.AR.A.030\(c\)](#) and [ADR.AR.A.040](#) of Annex II;

- (b) when implementing the measures referred to in point (a), coordinate with the aerodrome operator and the air traffic service provider, where necessary.

*[applicable from 20 March 2022]*

## ADR.OR.F.045 Management system

*Delegated Regulation (EU) 2020/1234*

- (a) The organisation responsible for the provision of AMS, the aerodrome operator or the air traffic service provider, when the latter is partially or exclusively providing apron management services, shall implement and maintain a management system that integrates a safety management system that also covers those activities.
- (b) The management system shall include:
- (1) clearly defined lines of responsibility and accountability throughout the organisation, including a direct accountability for safety on the part of the senior management;
  - (2) a description of the overall philosophies and principles of the organisation responsible for the provision of AMS with regard to safety, referred to as the safety policy, signed by the accountable manager;
  - (3) a formal process that ensures that hazards in operations are identified;
  - (4) a formal process that ensures analysis, assessment and mitigation of the safety risks in the provision of apron management service;
  - (5) the means to verify the safety performance of the organisation responsible for the provision of AMS in reference to the safety performance indicators and safety performance targets of the safety management system, and to validate the effectiveness of safety risk controls;
  - (6) a formal process to:
    - (i) identify changes within the organisation, its management system, or the provision of apron management service which may affect established processes, procedures and services;
    - (ii) describe the arrangements to ensure safety performance before implementing changes;
    - (iii) eliminate or modify safety risk controls that are no longer needed or effective due to changes in the operational environment;
  - (7) a formal process to review the management system referred to in point (a), identify the cause(s) of substandard performance of the safety management system, determine the implications of such substandard performance in operations, and eliminate or mitigate such cause(s);
  - (8) a safety training programme that ensures that personnel involved in the provision of apron management service are trained and competent to perform the safety management duties;
  - (9) formal means for safety communication that ensures that personnel are fully aware of the safety management system, conveys safety-critical information, and explains why particular safety actions are taken and why safety procedures are introduced or changed;

- (10) a formal process to monitor the compliance of the organisation with the relevant requirements.
- (c) The organisation responsible for the provision of AMS shall document all management system key processes in a manual.

*[applicable from 20 March 2022]*

## AMC1 ADR.OR.F.045(b)(1) Management system

*ED Decision 2020/021/R*

### SAFETY MANAGEMENT SYSTEM

The management system of the organisation responsible for the provision of AMS should encompass safety by establishing an organisational structure for the management of safety which is proportionate and appropriate to the size of the organisation and the complexity and type of its operations.

Depending on the size of the organisation and the type and complexity of its operations, the safety management system should include the establishment of internal safety committees.

*[applicable from 20 March 2022]*

## GM1 ADR.OR.F.045(b)(1) Management system

*ED Decision 2020/021/R*

### INTERNAL SAFETY COMMITTEES

Organisations responsible for the provision of AMS may find it beneficial to establish a Safety Review Board and Safety Action Groups, and depending on their organisational complexity and structure, Safety Services Office to support Safety Manager in the execution of the assigned tasks, especially in cases where the organisation provides AMS in multiple aerodromes.

*[applicable from 20 March 2022]*

## GM2 ADR.OR.F.045(b)(1) Management system

*ED Decision 2020/021/R*

### SAFETY SERVICES OFFICE

- (a) The Safety Services Office is managed by the Safety Manager and is independent and neutral in terms of the processes and decisions made regarding the provision of services by the operational unit(s).
- (b) The functions of the Safety Services Office normally support the Safety Manager in the following:
- (1) the management and oversight of the hazard identification system;
  - (2) the monitoring of the safety performance of the operational unit(s) that is (are) directly involved in the provision of apron management services (AMS);
  - (3) the provision of advice to the senior management on safety management matters; and
  - (4) the provision of assistance to line managers on safety management matters.

*[applicable from 20 March 2022]*

**GM3 ADR.OR.F.045(b)(1) Management system**

ED Decision 2020/021/R

**SAFETY REVIEW BOARD AND SAFETY ACTION GROUP**

- (a) The Safety Review Board:
- (1) is a high-level safety committee that considers matters of strategic safety in support of the accountable manager's safety accountability; and
  - (2) is chaired by the accountable manager and composed of heads of functional areas.
- (b) The Safety Review Board monitors:
- (1) the organisation's safety performance against the safety policy and safety objectives;
  - (2) that any safety action is taken in a timely manner; and
  - (3) the effectiveness of the organisation's safety management processes.
- (c) The Safety Review Board ensures that appropriate resources are allocated for the organisation to achieve the safety objectives.
- (d) The safety manager or any other relevant person, as appropriate, may attend the Safety Review Board meetings. They may communicate to the accountable manager all the relevant information, as necessary, to allow decision-making based on safety data.
- (e) Depending on the size of the organisation and the type and complexity of its operations, the responsibilities of the Safety Review Board may be transferred in other high-level committees of the organisation.
- (f) The Safety Action Group
- (1) The Safety Action Group may be established as a standing group, or as an ad hoc group, to assist or act on behalf of the Safety Review Board;
  - (2) More than one Safety Action Group may be established, depending on the scope of the task and the specific expertise required;
  - (3) The Safety Action Group reports to, and takes strategic direction from, the Safety Review Board, and is comprised of managers, supervisors, and personnel from operational areas.
  - (4) The Safety Action Group:
    - (i) monitors operational safety;
    - (ii) resolves identified risks;
    - (iii) assesses the impact of operational services on safety;
    - (iv) ensures that safety actions are implemented within the agreed timescales.
  - (5) The Safety Action Group reviews the effectiveness of previous safety recommendations and safety promotion activities.

*[applicable from 20 March 2022]*



## GM4 ADR.OR.F.045(b){1} Management system

*ED Decision 2020/021/R*

### SAFETY SERVICES OFFICE, SAFETY REVIEW BOARD AND SAFETY ACTION GROUP

Different terms may also be used for the Safety Services Office, the Safety Review Board and the Safety Actions Group.

*[applicable from 20 March 2022]*

## AMC1 ADR.OR.F.045(b)(2) Management system

*ED Decision 2020/021/R*

### SAFETY POLICY

- (a) The safety policy should:
- (1) be endorsed by the accountable manager;
  - (2) clearly identify safety as the highest organisational priority;
  - (3) reflect organisational commitments regarding safety and its proactive and systematic management;
  - (4) be communicated, with visible endorsement, throughout the organisation;
  - (5) include safety reporting principles; and
  - (6) be periodically reviewed to ensure it remains relevant and appropriate to the organisation.
- (b) The safety policy should:
- (1) include a commitment to:
    - (i) improve towards the highest safety standards;
    - (ii) comply with all applicable legal requirements, meet all applicable standards, and consider best practices;
    - (iii) provide appropriate resources;
    - (iv) enforce safety as the primary responsibility of all managers and personnel;
  - (2) include safety reporting procedures;
  - (3) with reference to just culture, clearly indicate which types of operational behaviours are unacceptable, and include the conditions under which disciplinary action would not apply; and
  - (4) be periodically reviewed to ensure it remains relevant and appropriate to the organisation.
- (c) Senior management should:
- (1) continually promote the safety policy to all personnel, and demonstrate their commitment to it;
  - (2) provide the necessary human and financial resources for its implementation; and
  - (3) establish safety objectives and performance standards.

*[applicable from 20 March 2022]*

## GM1 ADR.OR.F.045(b)(2) Management system

*ED Decision 2020/021/R*

### SAFETY POLICY

(a) Safety policy — General

The safety policy is the means whereby the organisation states its intention to maintain and, where practicable, improve the level of safety in all its activities, and to minimise the risk of an aircraft accident as far as reasonably practicable.

The safety policy states that the purpose of safety reporting and internal investigations is to improve safety, and not to apportion blame to individuals.

(b) Safety policy — Just culture

The safety policy actively encourages effective safety reporting and, by defining the line between acceptable performance (often unintended errors) and unacceptable performance (such as negligence, recklessness, violations, or sabotage), provides fair protection to reporters. A safety or just culture may not, however, preclude the ‘criminalisation of error’, which is legally, ethically, and morally within the sovereign rights of any Member State, provided European Union law and established international agreements are observed. A judicial investigation, and consequences of some form, may be expected following an accident or serious incident especially if a failure resulted in lives lost or property damaged, even if no negligence or ill intent existed. A potential issue could, therefore, exist if voluntary hazard reports, which relate to latent deficiencies of a system or its performance, are treated in the same way as those concerning accident and serious incident investigations. The intent of protecting hazard reports will not be to challenge the legitimacy of a judicial investigation, or demand undue immunity. However, legal argument does usually take precedence over any technical- or safety-related argument.

*[applicable from 20 March 2022]*

## AMC1 ADR.OR.F.045(b)(3) Management system

*ED Decision 2020/021/R*

### HAZARD IDENTIFICATION PROCESS

(a) The organisation responsible for the provision of AMS should coordinate the hazard identification process with the aerodrome operator and, where necessary, the air traffic services (ATS) provider.

(b) Hazard identification should be based on a combination of reactive, proactive, and predictive methods of safety data collection. Reactive, proactive, and predictive schemes for hazard identification should be the formal means of collecting, recording, analysing, acting on, and generating feedback about hazards and the associated risks that affect safety.

(c) All reporting systems, including confidential reporting schemes, should include an effective feedback process.

*[applicable from 20 March 2022]*

**GM1 ADR.OR.F.045(b){3} Management system**

ED Decision 2020/021/R

**HAZARD IDENTIFICATION**

## (a) Hazard identification — General

- (1) Hazard identification may include the following factors and processes:
  - (i) design factors, including equipment and task design;
  - (ii) procedures and operating practices, including the related documentation and checklists, and their validation under actual operating conditions;
  - (iii) communications, including the means, terminology and language;
  - (iv) personnel factors, such as company policies for recruitment, training, remuneration, and allocation of resources;
  - (v) organisational factors, such as the compatibility of production and safety goals, the allocation of resources, operating pressure, and the corporate safety culture;
  - (vi) work environment factors, such as ambient noise and vibration, temperature, lighting, and the availability of protective equipment and clothing;
  - (vii) regulatory oversight factors, including the applicability and enforceability of regulations, the certification of equipment, personnel, and procedures, and the adequacy of oversight;
  - (viii) defences, including factors such as the provision of adequate detection and warning systems, the error tolerance of equipment, and the resilience of equipment to errors and failures; and
  - (ix) human performance, restricted to medical conditions and physical limitations.
- (2) For hazard identification, internal and external sources may be used.
  - (i) Internal sources:
    - (A) voluntary occurrence-reporting schemes;
    - (B) safety surveys;
    - (C) safety audits;
    - (D) normal operations monitoring schemes;
    - (E) trend analysis;
    - (F) feedback from training; and
    - (G) investigation of incidents and follow-up.
  - (ii) External sources:
    - (A) accident reports;
    - (B) State mandatory occurrence-reporting system; and
    - (C) State voluntary occurrence-reporting system.
- (3) The methods used for hazard identification depend on the resources and constraints of each particular organisation, and on the size and complexity of its operations.

Nevertheless, hazard identification, regardless of implementation, complexity and size, is part of the organisation's safety documentation. In the context of mature safety management practices, hazard identification is a continuous, daily activity. It is an integral part of the organisation's processes. There are three specific conditions under which special attention to hazard identification should be paid. These three conditions should trigger more in-depth and far-reaching hazard identification activities, and include:

- (i) any time the organisation experiences an unexplained increase in safety-related events or regulatory infractions;
  - (ii) any time major operational changes are foreseen, including changes to key personnel or other major equipment or systems; and
  - (iii) before and during periods of significant organisational changes, including rapid growth or contraction, corporate mergers, acquisitions, or downsizing.
- (4) For hazard identification, the following tools and techniques may be used:
- (i) brainstorming, which is an unbounded but facilitated discussion with a group of experts;
  - (ii) the *hazard and operability* (HAZOP) study, which is a systematic and structured approach using parameter and deviation guidewords. This technique relies on a very detailed system description being available for study, and usually involves breaking down the system into well-defined subsystems and functional or process flows between subsystems. Each element of the system is then subject to discussion within a multidisciplinary group of experts against the various combinations of the guidewords and deviations;
  - (iii) checklists, which are lists of known hazards or hazard causes that have been derived from past experience. Past experience could be previous risk assessments, or similar systems, or operations, or from actual incidents that have occurred in the past. This technique involves the systematic use of an appropriate checklist, and the consideration of each item on the checklist for possible applicability to a particular system. Checklists are always validated for applicability prior to use;
  - (iv) the *failure modes and effects analysis* (FMEA), which is a 'bottom-up' technique used to consider ways in which the basic components of a system can fail to perform their design intent. This technique relies on a detailed system description, and considers the ways in which each subcomponent of the system could fail to meet its design intent, and what the consequences could be for the overall system. For each subcomponent of a system, the FMEA considers:
    - (A) all the potential ways that the component could fail;
    - (B) the effects that each of these failures would have on the system behaviour;
    - (C) the possible causes of the various failure modes; and
    - (D) how the failures might be mitigated within the system or its environment.

The system level at which the analysis is applied can vary, and is determined by the level of detail of the system description used to support the analysis. Depending on the nature and complexity of the system, the analysis could be undertaken by an individual system expert, or by a team of system experts that act in group sessions.

- 
- (v) the *structured what-if technique* (SWIFT) is a simple and effective technique, alternative to the HAZOP study, and involves a multidisciplinary team of experts. It is a facilitated brainstorming group activity, but is typically carried out on a higher-level system description, having fewer sub-elements than the HAZOP study and with a reduced set of prompts.
- (5) Identified hazards are registered in a hazard log (hazard register). The nature and format of such a hazard log may vary from a simple list of hazards to a more sophisticated relational database linking hazards to mitigations, responsibilities, and actions. The following information is included in the hazard log:
- (i) unique hazard reference number against each hazard;
  - (ii) hazard description;
  - (iii) indication of the potential causes of the hazard;
  - (iv) qualitative assessment of the possible outcomes and severities of the consequences arising from the hazard;
  - (v) qualitative assessment of the risk associated with the possible consequences of the hazard;
  - (vi) description of the existing risk controls for the hazard; description of additional actions that are required to reduce safety risks, as well as target date of their completion; and
  - (vii) indication of responsibilities in relation to the management of risk controls.
- (6) Additionally, the following information may also be included in the hazard log:
- (i) a quantitative assessment of the risk associated with the possible consequences of the hazard;
  - (ii) record of actual incidents or events related to the hazard, or its causes;
  - (iii) risk-tolerability statement;
  - (iv) statement of formal system-monitoring requirements;
  - (v) indication of how the hazard was identified;
  - (vi) hazard owner;
  - (vii) assumptions; and
  - (viii) third-party stakeholders.
- (b) Hazard identification — Indicators
- (1) Reactive (lagging) indicators:
- Metrics that measure events which have already occurred and that impact on safety performance.
- As reactive (lagging) indicators only reflect system failures, their use can only result in determining a reactive response. Although they do measure failure to control hazards, they do not normally reveal why the system failed, or if there are any latent hazards.

(2) Proactive (leading) indicators:

Metrics that measure inputs to the safety system (either within an organisation, a sector, or across the total aviation system) to manage and improve safety performance.

Proactive (leading) indicators indicate good safety practices being introduced, developed and adapted, which, by their inclusion, seek to establish a proactive safety environment that engenders continuous improvement. They provide useful information when accident and incident rates are low to identify latent hazards and potential threats, and consequent opportunities for improvement.

There should always be a connection between a proactive indicator and the unwanted outcomes (or reactive indicators) that their monitoring is intended to warn against.

(3) Predictive indicators (precursor events):

These metrics can be considered as indicators that do not manifest themselves in accidents or serious incidents. They indicate less severe system failures or 'near misses' which, when combined with other events, may lead to an accident or a serious incident.

In a large organisation, a mature safety management system includes all these measures. Risk-management efforts, however, are targeted at proactive (leading) indicators and predictive indicators (precursor events).

*[applicable from 20 March 2022]*

## AMC1 ADR.OR.F.045(b)(4) Management system

ED Decision 2020/021/R

### SAFETY RISK ASSESSMENT AND RISK MITIGATION

- (a) A formal safety risk assessment and risk-mitigation process should be developed and maintained that ensures risk analysis (in terms of probability and severity of occurrence), risk assessment (in terms of tolerability), and risk control (in terms of mitigation).
- (b) The levels of management that have the authority to make decisions regarding the tolerability of safety risks, in accordance with (a) above, should be specified in the management manual. The decisions should be coordinated with the aerodrome operator and, where necessary, the air traffic services (ATS) provider.

*[applicable from 20 March 2022]*

## GM1 ADR.OR.F.045(b)(4) Management system

ED Decision 2020/021/R

### SAFETY RISK ASSESSMENT AND RISK MITIGATION

Safety risk assessment is the analysis of the safety risks of the consequences of the hazards that have been determined.

The safety risk analysis breaks down the risks into two components:

- the probability of occurrence of a damaging event or condition, and
- the severity of the damaging event or condition, should it occur.

Safety risk decision-making and acceptance should be specified through a risk-tolerability matrix. The definition and final construction of the matrix is left to the aerodrome operator to design, is documented in the aerodrome manual, and is subject to approval by the Competent Authority.

*[applicable from 20 March 2022]*

## AMC1 ADR.OR.F.045(b)(5) Management system

*ED Decision 2020/021/R*

### SAFETY PERFORMANCE MONITORING AND MEASUREMENT

- (a) Safety performance monitoring and measurement should be the process by which the safety performance of the organisation responsible for the provision of AMS is verified in comparison to the established safety policy and objectives, identified safety risks and the risk-mitigation measures.
- (b) This process should include the setting of safety performance indicators and safety performance targets, and measuring the organisation's safety performance against them.
- (c) The safety performance indicators and targets should be agreed with the aerodrome operator and should not contravene the safety performance indicators and targets of the aerodrome operator and, where applicable, the air traffic services (ATS) provider.

*[applicable from 20 March 2022]*

## GM1 ADR.OR.F.045(b)(5) Management system

*ED Decision 2020/021/R*

### SAFETY PERFORMANCE MONITORING AND MEASUREMENT

- (a) The performance monitoring and measurement process includes:
  - (1) safety reporting, addressing also the status of the organisation's compliance with the applicable requirements;
  - (2) safety studies which are rather large analyses encompassing broad safety concerns;
  - (3) safety reviews, including trends reviews which are conducted during the introduction and deployment of new technologies, change or implementation of procedures, or in situations of structural changes in operations, or to explore the increase in incidents or safety reports;
  - (4) safety audits which focus on the integrity of the organisation's management system, and periodically assess the status of safety risk controls;
  - (5) safety surveys which examine particular elements or procedures of a specific operation, such as problem areas or bottlenecks in daily operations, perception and opinions of operational personnel, and areas of dissent or confusion; and
  - (6) internal safety investigations of occurrences.
- (b) The following generic aspects/areas may be considered:
  - (1) accountability for the management of the operational activities and their ultimate accomplishment;
  - (2) authority to direct, control or change the procedures, as well as to make key decisions such as safety risk acceptance decisions;

- (3) procedures for operational activities;
- (4) controls, including hardware, software, special procedures or procedural steps, and supervisory practices designed to keep operational activities on track;
- (5) interfaces, including lines of authority between departments, lines of communication between employees, consistency of procedures, and clear delineation of responsibility between organisations, work units, and employees; and
- (6) process measures to provide feedback to parties in charge that required actions are taking place, required outputs are being produced, and expected outcomes are being achieved.

*[applicable from 20 March 2022]*

## AMC1 ADR.OR.F.045(b)(6) Management system

*ED Decision 2020/021/R*

### CHANGE MANAGEMENT

The organisation responsible for the provision of AMS should manage the safety risks related to a change. The management of a change should be a documented process to identify external and internal changes that may have an adverse effect on safety.

The management of a change should make use of the organisation's existing hazard identification, safety risk assessment, and mitigation processes.

*[applicable from 20 March 2022]*

## GM1 ADR.OR.F.045(b)(6) Management system

*ED Decision 2020/021/R*

### CHANGE MANAGEMENT

- (a) A change can introduce new hazards and impact on the appropriateness and/or effectiveness of existing safety risk mitigation strategies. A change may be external to the organisation, or internal.
- (b) A formal process for the management of change considers the following:
  - (1) the criticality of systems and activities;
  - (2) the stability of systems and operational environments; and
  - (3) the organisation's past performance.
- (c) System description is one of the fundamental preliminary activities in the planning of the safety management system to determine a baseline hazard analysis for the system.

As part of the formal process of the management of change, the system description and the baseline hazard analysis are reviewed periodically, even if circumstances of change are not present, to determine their continued validity.

When changes to the system are made, and periodically thereafter, the organisation responsible for the provision of AMS goes over its system and its actual operational environment in order to make sure it continues to be fully aware of the circumstances under which the provision of AMS takes place.



With regard to the management of change and safety (risk) assessments related to changes, see also [ADR.OR.F.025](#) and [GM1 ADR.OR.F.025\(d\)](#).

*[applicable from 20 March 2022]*

## AMC1 ADR.OR.F.045(b)(7) Management system

*ED Decision 2020/021/R*

### CONTINUOUS IMPROVEMENT OF THE SAFETY MANAGEMENT SYSTEM

The organisation responsible for the provision of AMS should continuously seek to improve its safety performance. The organisation should develop and maintain a relevant formal process in this regard. Continuous improvement should be achieved through:

- (a) the proactive and reactive evaluation of facilities, equipment, documentation and procedures;
- (b) the proactive evaluation of an individual's performance to verify they fulfil their safety responsibilities; and
- (c) reactive evaluations to verify the effectiveness of the system as regards the control and mitigation of safety risks.

*[applicable from 20 March 2022]*

## GM1 ADR.OR.F.045(b)(7) Management system

*ED Decision 2020/021/R*

### CONTINUOUS IMPROVEMENT OF THE SAFETY MANAGEMENT SYSTEM

The continuous improvement of the safety management system, as part of the safety assurance, is achieved through the following:

- (a) internal evaluations;
- (b) independent audits, both internal and external;
- (c) strict document controls; and
- (d) continuous monitoring of safety controls and mitigation actions.

*[applicable from 20 March 2022]*

## AMC1 ADR.OR.F.045(b)(8) Management system

*ED Decision 2020/021/R*

### SAFETY MANAGEMENT SYSTEM TRAINING

- (a) The organisation responsible for the provision of AMS should establish a safety management system training programme for all personnel involved in the provision of AMS, including all management staff (e.g. supervisors, managers, senior managers, and the accountable manager), regardless of their position in the hierarchy of the organisation.
- (b) The amount and level of detail of the safety management system training should be proportionate and appropriate to the individual's responsibilities and involvement in the safety management system of the organisation.
- (c) The safety management system training programme should be developed in accordance with [AMC1 ADR.OR.D.017\(a\);\(b\)](#) and be incorporated in the training programme foreseen therein.

[applicable from 20 March 2022]

## GM1 ADR.OR.F.045(b)(8) Management system

ED Decision 2020/021/R

### SAFETY MANAGEMENT SYSTEM TRAINING — PERSONNEL REQUIREMENTS

- (a) Operations and maintenance personnel
- (1) The safety management system training addresses all safety-related responsibilities, including adherence to all operational and safety procedures, and identifying and reporting hazards.
  - (2) The training objectives include the organisation's safety policy and safety management system fundamentals and overview.
  - (3) The training contents include the following:
    - (i) the definition of hazards;
    - (ii) the consequences of hazards and risks;
    - (iii) the safety risk management process, including roles and responsibilities; and
    - (iv) safety reporting and the organisation's safety reporting system(s).
- (b) Managers and supervisors
- (1) The safety management system training addresses safety-related responsibilities, including the promotion of the safety management system (SMS) and engaging operational personnel in hazard reporting.
  - (2) In addition to the training objectives established for operational personnel, the training objectives for managers and supervisors include a detailed knowledge of the safety process, hazard identification and safety risk management and mitigation, and change management.
  - (3) In addition to the contents specified for operational personnel, the training contents for supervisors and managers include safety data analysis.
- (c) Senior managers
- (1) The safety management system training would include safety-related responsibilities, including compliance with European Union, national and the organisation's own safety requirements, allocation of resources, ensuring effective inter-departmental safety communication, and active promotion of the safety management system.
  - (2) In addition to the objectives for the two previous employee groups, the safety management system training includes also safety assurance and safety promotion, safety roles and responsibilities, and the establishment of an acceptable level of safety.
- (d) Accountable manager
- The training would provide the accountable manager with a general awareness of the organisation's safety management system, including safety management system roles and responsibilities, safety policy and objectives, safety risk management, and safety assurance.

[applicable from 20 March 2022]

## AMC1 ADR.OR.F.045(b)(9) Management system

ED Decision 2020/021/R

### SAFETY COMMUNICATION

- (a) The organisation responsible for the provision of AMS should communicate the safety management system objectives and procedures to all operational personnel, and the safety management system and its application should be evident in all aspects of the organisation's operations.
- (b) There should be a communication flow between the safety manager and the operational personnel throughout the organisation. The safety manager should communicate the performance of the organisation's safety management system via suitable means. The safety manager should also ensure that lessons learned from investigations, safety-related events or other safety-related experience, both internally and from other organisations, are distributed widely within the organisation.
- (c) Safety communication should aim to:
  - (1) ensure that all staff are fully aware of the organisation's safety management system;
  - (2) convey safety-critical information;
  - (3) explain why particular actions are taken; and
  - (4) explain why safety procedures are introduced or changed.

*[applicable from 20 March 2022]*

## GM1 ADR.OR.F.045(b)(9) Management system

ED Decision 2020/021/R

### SAFETY COMMUNICATION

- (a) The following means may be used to communicate safety information:
  - (1) the safety management system (SMS) manual;
  - (2) safety processes and procedures;
  - (3) safety newsletters, notices, and bulletins; and
  - (4) websites or emails.
- (b) Regular meetings with staff, where information, actions and procedures are discussed, may also be used to communicate safety information.

*[applicable from 20 March 2022]*

## AMC1 ADR.OR.F.045(b)(10) Management system

ED Decision 2020/021/R

### COMPLIANCE MONITORING

- (a) Compliance monitoring
  - (1) The implementation and use of a compliance-monitoring process should enable the organisation responsible for the provision of AMS to monitor the organisation's compliance with the relevant requirements of this Part, of Part-ADR.OPS, as well as with

- any other applicable regulatory requirements, or requirements established by the aerodrome operator or the air traffic services (ATS) provider.
- (2) The compliance-monitoring process should be properly implemented, maintained and continually reviewed and improved, as necessary.
  - (3) Compliance monitoring should include a system to feed findings back to the accountable manager to ensure the effective implementation of corrective actions, as necessary.
  - (4) The organisation responsible for the provision of AMS should monitor the consistent application of its procedures, and compliance with the applicable procedures of the aerodrome operator and of the ATS provider to ensure that the activities are performed safely. In doing so, the AMS provider should, as a minimum, and where appropriate, monitor compliance with:
    - (i) its privileges;
    - (ii) the manuals, logs, and records;
    - (iii) the training standards;
    - (iv) the required resources;
    - (v) the management system procedures and manuals; and
    - (vi) the activities of the organisation carried out under the supervision of the person nominated in accordance with point ADR.OR.F.065(a)(2).
- (b) Organisational set-up
- (1) To ensure that the organisation continues to meet the requirements of this Part and of other applicable parts, the accountable manager should designate a person responsible for compliance monitoring.
  - (2) Compliance monitoring should be an independent function. If the person responsible for compliance monitoring has also another function, that person's independence should be established by ensuring that audits and inspections are carried out by personnel that are not responsible for the function, procedure, etc., being audited.
  - (3) Staff involved in compliance monitoring should have access to any part of the organisation and, as necessary, to any contracted organisation.
- (c) Compliance-monitoring documentation
- (1) Relevant documentation should include the relevant part(s) of the organisation's management system documentation.
  - (2) In addition, relevant documentation should also include the following:
    - (i) terminology;
    - (ii) specified activity standards;
    - (iii) a description of the organisation;
    - (iv) the allocation of duties and responsibilities;
    - (v) procedures to ensure regulatory compliance;
    - (vi) the compliance-monitoring programme which reflects:
      - (A) the schedule of the monitoring programme;

- (B) audit procedures, including an audit plan that is implemented, maintained and continually reviewed and improved;
  - (C) reporting procedures;
  - (D) follow-up and corrective action procedures; and
  - (E) the recording system;
  - (vii) the training syllabus referred to in point (d)(2) below; and
  - (viii) document control.
- (d) Training
- (1) Proper and thorough training is essential to optimise compliance. In order to achieve optimum outcome of such training, the AMS provider should ensure that all personnel understand the objectives as laid down in the AMS provider's management system documentation.
  - (2) The staff member responsible for managing compliance monitoring should receive training in this task. Such training should cover the compliance-monitoring requirements, the manuals and procedures related to the task, audit techniques, reporting, and recording.
  - (3) The time should be provided to train the staff involved in compliance management, and for briefing the rest of the staff.
  - (4) The allocation of time and resources should be based on the volume and complexity of the activities concerned.
- (e) Compliance monitoring — audit scheduling
- (1) Defined audit schedules to be completed during a specified period as well as a periodic review cycle for each audited area should be established. The compliance monitoring itself should also be audited according to a defined audit schedule. The schedule should allow for unscheduled audits when non-compliance data shows an increasing trend. Follow-up audits should be scheduled to verify that corrective action has been carried out, and that it has been effective and completed, in accordance with the policies and procedures specified in the aerodrome manual.
  - (2) The management system's key processes, procedures and the operation of the organisation responsible for the provision of AMS should be audited within the first 12 months from the date on which the declaration was first registered.
  - (3) Following that, the organisation responsible for the provision of AMS should consider the results of its safety (risk) assessments and of its past compliance-monitoring activities in order to adapt the period within which an audit or a series of audits should be conducted, to cover its management system's key processes, procedures and operations in a manner and at intervals set out in the management system manual. This period should be consistent with the relevant Competent Authority's oversight planning cycle and may be extended up to 36 months, in coordination with the Competent Authority, provided that there are no level 1 findings, and subject to the organisation responsible for the provision of AMS having a good record of addressing findings in a timely manner.

*[applicable from 20 March 2022]*

## GM1 ADR.OR.F.045(b)(10) Management system

ED Decision 2020/021/R

### COMPLIANCE MONITORING — GENERAL

- (a) The person responsible for compliance monitoring may perform all audits and inspections themselves or may appoint one or more auditors by choosing staff, either from within or outside the organisation, which have the related competence as defined in point (d) of [AMC2 ADR.OR.F.045\(b\)\(10\)](#).
- (b) Regardless of the option chosen in point (a) above, the organisation ensures that the independence of the audit function is not affected, particularly in cases where staff that perform the audit or the inspection are also responsible for other functions within the organisation.
- (c) If external staff are used to perform compliance audits or inspections:
  - (1) such audits or inspections would be performed under the responsibility of the person responsible for compliance monitoring; and
  - (2) the organisation responsible for the provision of AMS remains responsible for ensuring that external staff have the appropriate knowledge, background and experience with regard to the activities being audited or inspected, including knowledge of and experience in compliance monitoring.
- (d) The organisation responsible for the provision of AMS has the ultimate responsibility for the effectiveness of compliance monitoring, particularly for the effective implementation and follow-up of all corrective actions.

[applicable from 20 March 2022]

## AMC2 ADR.OR.F.045(b)(10) Management system

ED Decision 2020/021/R

### RESPONSIBILITY FOR COMPLIANCE MONITORING

- (a) The responsibility for compliance monitoring should:
  - (1) lie with a person that has direct access and is responsible to the accountable manager;
  - (2) not lie with a person that is nominated in accordance with point ADR.OR.F.065(a)(2).
- (b) Depending on the size of the organisation and the type and complexity of its operations, the task of compliance monitoring may be performed by the accountable manager provided they have demonstrated they have the related competence as defined in point (d) below.
- (c) If the same person acts both as compliance-monitoring manager and as safety manager, the accountable manager, with regard to their direct accountability as regards safety, should ensure that sufficient resources are allocated to both functions, taking into account the size of the organisation and the type and complexity of its operations.
- (d) Persons that are allocated the responsibility for compliance monitoring should have:
  - (1) adequate experience and expertise in aerodrome operations or in the provision of apron management services (AMS) or air traffic services (ATS);
  - (2) adequate knowledge of and experience in safety management and quality assurance;
  - (3) knowledge of the aerodrome manual and as regards the organisation responsible for the provision of AMS, of its management manual; and

- (4) comprehensive knowledge of the applicable requirements in the area of aerodromes, AMS or ATS.

*[applicable from 20 March 2022]*

## AMC1 ADR.OR.F.045(c) Management system

*ED Decision 2020/021/R*

### MANAGEMENT SYSTEM DOCUMENTATION

The organisation responsible for the provision of AMS should ensure that the key processes of its documented management system include a process for making personnel aware of their responsibilities, as well as its amendment procedure.

The documented management system of the organisation responsible for the provision of AMS should include at least the following information:

- (a) a statement signed by the accountable manager confirming that the organisation will continuously work in accordance with the applicable requirements, with the requirements of the aerodrome operator and of the air traffic services (ATS) provider, and with the organisation's documented management system;
- (b) the organisation's scope of activities;
- (c) the titles and names of the persons referred to in point [ADR.OR.F.065](#) and in [AMC2 ADR.OR.F.045\(b\)\(10\)](#);
- (d) an organisation chart showing the lines of responsibility between the nominated persons;
- (e) the procedures specifying how the organisation ensures compliance with the applicable requirements;
- (f) the amendment procedure for the organisation's management system documentation; and
- (g) the safety management system outputs.

*[applicable from 20 March 2022]*

## AMC2 ADR.OR.F.045(c) Management system

*ED Decision 2020/021/R*

### SAFETY MANAGEMENT MANUAL

- (a) For cases where safety management is set out in a safety management manual, it should be the key instrument for communicating the approach of the organisation responsible for the provision of AMS to safety. The safety management manual should document all aspects of safety management, including the safety policy, its objectives, procedures, and the safety responsibilities of individuals.
- (b) The safety management manual should include the following:
  - (1) the scope of the safety management system;
  - (2) the safety policy and its objectives;
  - (3) the safety responsibilities of key safety personnel;
  - (4) the documentation control procedures;

- (5) the safety assessment process, including hazard identification and risk management schemes;
- (6) the monitoring of implementation and the effectiveness of the safety actions and risk mitigation measures;
- (7) safety performance monitoring;
- (8) safety reporting (including hazard reporting) and investigation;
- (9) the change management (including organisational changes with regard to safety responsibilities);
- (10) safety promotion; and
- (11) safety management system outputs.

*[applicable from 20 March 2022]*

## GM1 ADR.OR.F.045(c) Management system

*ED Decision 2020/021/R*

### MANAGEMENT SYSTEM DOCUMENTATION

It is not required to duplicate information in several manuals. The safety management manual is considered part of the management manual of the organisation responsible for the provision of AMS.

*[applicable from 20 March 2022]*

## ADR.OR.F.050 Reporting malfunctions of systems used for the provision of apron management services

*Delegated Regulation (EU) 2020/1234*

Without prejudice to [Regulation \(EU\) No 376/2014](#), the organisation responsible for the provision of AMS shall report to the Competent Authority of the State where the aerodrome is located, to the aerodrome operator and to the organisation responsible for the design of any aerodrome equipment used for the provision of apron management service, any malfunction, technical defect, exceeding of technical limitations, occurrence or other irregular circumstance that has or may have endangered safety and that has not resulted in an accident or a serious incident.

*[applicable from 20 March 2022]*

## ADR.OR.F.055 Safety reporting system

*Delegated Regulation (EU) 2020/1234*

- (a) The organisation responsible for the provision of AMS shall establish and implement a safety reporting system for its personnel.
- (b) As part of the process referred to in point [ADR.OR.F.045\(b\)\(3\)](#), the organisation responsible for the provision of AMS shall ensure that:
  - (1) its personnel use the safety reporting system for the mandatory reporting of any accident, serious incident and occurrence;
  - (2) the safety reporting system may be used for the voluntary reporting of any defect, fault and safety hazard which could impact safety.



- (c) The safety reporting system shall protect the identity of the reporter, encourage voluntary reporting and include the possibility that reports may be submitted anonymously.
- (d) The organisation responsible for the provision of AMS shall:
  - (1) record all reports submitted;
  - (2) transmit the reports to the aerodrome operator, and, if relevant, to the air traffic service provider;
  - (3) in cooperation with the aerodrome operator or the air traffic service provider, or both, analyse and assess the reports, in order to address safety deficiencies and identify trends;
  - (4) participate in the investigation of the reports conducted by the aerodrome operator, as appropriate;
  - (5) refrain from attribution of blame in line with the “just culture” principles.

*[applicable from 20 March 2022]*

## AMC1 ADR.OR.F.055 Safety reporting system

*ED Decision 2020/021/R*

### SAFETY REPORTING SYSTEM

- (a) The safety reporting system should include the personnel of the organisation which are responsible for the provision of AMS.
- (b) The safety reporting system should include the possibility for voluntary reporting intended for safety hazards identified by the reporter which may have potential negative consequences on safety.
- (c) The organisation responsible for the provision of AMS should identify which events are mandatory to be reported.
- (d) The organisation responsible for the provision of AMS should provide the means and the format for reporting, which should be such that they meet the existing reporting requirements established in the applicable legislation in terms of time, format, and required information to be reported.
- (e) The safety reporting system should include the acknowledgement to the reporter of the successful submission of the report.
- (f) The reporting process should be as simple as possible, and well documented, including details on what, how, where, whom, and when to report.
- (g) Regardless of the means or method of submission of the report, once the information is received, it should be stored in a manner suitable for easy retrieval and analysis.
- (h) Access to the submitted reports should be restricted to personnel responsible for storing and analysing them.
- (i) The reporter’s identity should be protected, and this principle should be included in the procedures established by the organisation responsible for the provision of AMS for gathering additional information for further analyses or investigations.
- (j) The safety reporting system should include a feedback process to inform the reporter on the outcome of the occurrence analysis.

[applicable from 20 March 2022]

## GM1 ADR.OR.F.055 Safety reporting system

ED Decision 2020/021/R

### THE NEED FOR SAFETY REPORTING

- (a) The overall objective of the safety reporting system is to use reported information to improve the safety performance of the organisation, and not to attribute blame to individuals.
- (b) The specific objectives of the safety reporting system are to:
  - (1) enable an assessment to be made of the safety implications of each relevant occurrence, serious incident and accident, including similar past events, so that any necessary action can be initiated; and
  - (2) ensure that knowledge about such relevant occurrences, serious incidents and accidents is disseminated so that other persons and organisations may learn from them.

[applicable from 20 March 2022]

## AMC1 ADR.OR.F.055(a) Safety reporting system

ED Decision 2020/021/R

### GENERAL

The organisation responsible for the provision of AMS should establish procedures to be used for reporting to the Competent Authority and to any other organisation required, which should include the following:

- (a) the description of the applicable requirements for reporting;
- (b) the description of the reporting mechanism, including reporting forms, means, and deadlines;
- (c) the personnel responsible for reporting; and
- (d) the description of the mechanism and of personnel responsibilities for identifying root causes, and the actions that may be needed to be taken to prevent similar occurrences from happening in the future, as appropriate.

[applicable from 20 March 2022]

## ADR.OR.F.060 Safety programmes

Delegated Regulation (EU) 2020/1234

The organisation responsible for the provision of AMS shall participate in the safety programmes established by the aerodrome operator.

[applicable from 20 March 2022]

## ADR.OR.F.065 Personnel requirements

Delegated Regulation (EU) 2020/1234

- (a) The organisation responsible for the provision of AMS shall:
  - (1) appoint an accountable manager, who has the authority to ensure that all activities can be financed and carried out in accordance with the applicable requirements. The

- accountable manager shall be responsible for establishing and maintaining an effective management system;
- (2) nominate a person responsible for the management and supervision of operational services related to apron management;
  - (3) nominate a person responsible for the development, maintenance and day-to-day management of the safety management system. That person shall act independently of other managers within the organisation, shall have direct access to the accountable manager and to appropriate management for safety matters, and shall be responsible to the accountable manager;
  - (4) have sufficient and qualified personnel for the planned tasks and activities to be performed in accordance with the applicable requirements;
  - (5) assign a sufficient number of personnel supervisors to defined duties and responsibilities, taking into account the structure of the organisation and the number of personnel employed;
  - (6) ensure that personnel involved in the provision of apron management service are adequately trained in accordance with the training programme.
- (b) In the case that the aerodrome operator or the air traffic service provider are partially or exclusively providing apron management service, they shall ensure that the requirements of point (a) are included in their established allocation of responsibilities within their management systems.

*[applicable from 20 March 2022]*

## AMC1 ADR.OR.F.065(a)(1) Personnel requirements

*ED Decision 2020/021/R*

### ACCOUNTABLE MANAGER

- (a) Accountable manager — General
- (1) The accountable manager should:
    - (i) ensure that all necessary resources are available to deliver the services in accordance with the applicable requirements and the aerodrome manual;
    - (ii) ensure that if there is a reduction in the level of resources or if there are abnormal circumstances which may affect safety, the required reduction in the level of operations at the aerodrome is implemented in cooperation with the aerodrome operator and the air traffic services (ATS) provider;
    - (iii) establish, implement and promote the safety policy; and
    - (iv) ensure compliance with the relevant applicable requirements and the organisation's safety management system.
  - (2) The accountable manager should have:
    - (i) an appropriate level of authority within the organisation to ensure that its activities are financed and carried out to the standard required;
    - (ii) knowledge and an understanding of the documents that prescribe aerodrome and ATS safety standards;

- (iii) an understanding of the requirements as regards the competencies of management personnel so as to ensure that competent persons occupy key management functions;
  - (iv) knowledge and an understanding of safety and quality management systems related principles and practices and how these are applied within the organisation;
  - (v) knowledge of the role of the accountable manager; and
  - (vi) knowledge and an understanding of the key risk management issues as regards aerodrome operations.
- (b) Accountable manager — Delegation of responsibilities
- (1) A high level of technical knowledge and understanding is expected from an accountable manager, and in particular with reference to their own role in ensuring that standards are maintained.
  - (2) During periods of absence, the responsibilities of the accountable manager for the day-to-day operations may be delegated; however, the accountability ultimately remains with the accountable manager.
  - (3) Depending on the size and the complexity of the organisation's operations, the accountable manager may delegate their responsibilities in the area of training by nominating a training manager whose responsibilities should be the establishment, coordination, implementation of training programmes, and relevant record keeping of personnel training as well as of the proficiency check programmes.
- In any case, the accountability ultimately remains with the accountable manager.

*[applicable from 20 March 2022]*

## GM1 ADR.OR.F.065(a)(1) Personnel requirements

*ED Decision 2020/021/R*

### ACCOUNTABLE MANAGER

Depending on the size, structure and complexity of the organisation, the accountable manager may be:

- (a) the chief executive officer (CEO);
- (b) the chief operating officer (COO);
- (c) the chair of the board of directors;
- (d) a partner; or
- (e) the proprietor.

The appointment of an accountable manager, who is given the necessary authority and responsibilities, requires that the individual has the necessary competences to fulfil the role. The accountable manager may have more than one function in the organisation. Nonetheless, the accountable manager's role is to instil safety to personnel as a core organisational value, and to ensure that the safety management system is properly implemented and maintained through the allocation of resources and tasks.

*[applicable from 20 March 2022]*

## AMC1 ADR.OR.F.065(a)(2) Personnel requirements

ED Decision 2020/021/R

### NOMINATED PERSON RESPONSIBLE FOR THE MANAGEMENT AND SUPERVISION OF OPERATIONAL SERVICES RELATED TO APRON MANAGEMENT — OPERATIONS MANAGER

(a) General

- (1) A description of the functions of the operations manager, i.e. the person responsible for the management and supervision of operational services related to apron management, should be contained in the management manual. This person should be given the necessary and adequate resources to perform their duties.
- (2) The organisation responsible for the provision of AMS should make arrangements to ensure adequate supervision continuity in the absence of the operations manager.
- (3) The operations manager should be foreseen to work sufficient hours to fulfil the management functions, considering the scale and complexity of the operation.
- (4) The operations manager may hold more than one post if such an arrangement is considered suitable and it properly matches the structure of the organisation responsible for the provision of AMS and the complexity of its operations.

(b) Competence

The operations manager should have:

- (1) good practical experience and the appropriate expertise in aerodrome operations, apron management and/or air traffic services (ATS);
- (2) comprehensive knowledge of the applicable requirements in the area of aerodromes, apron management and/or ATS;
- (3) appropriate knowledge about safety and quality management; and
- (4) knowledge of the aerodrome manual and the organisation's management system manual.

*[applicable from 20 March 2022]*

## AMC1 ADR.OR.F.065(a)(3) Personnel requirements

ED Decision 2020/021/R

### SAFETY MANAGER

- (a) The safety manager should be the focal point and responsible for the effective development, coordination, administration and maintenance of a safety management system.
- (b) The role of the safety manager should be to:
  - (1) facilitate hazard identification, risk analysis and risk management;
  - (2) monitor the implementation and functioning of the safety management system, including the necessary safety actions;
  - (3) manage the safety reporting system of the organisation responsible for the provision of AMS;
  - (4) coordinate with the aerodrome operator and the air traffic services (ATS) provider as regards their safety management systems;

- 
- (5) produce periodic reports on the safety performance of the organisation;
  - (6) ensure the maintenance of the safety management documentation;
  - (7) ensure the availability of a safety management training and that it meets established standards;
  - (8) provide advice on safety matters; and
  - (9) initiate and participate in internal occurrence/incident/accident investigations.
- (c) The safety manager should have:
- (1) relevant practical experience and the appropriate expertise in aerodrome operations, apron management and/or ATS;
  - (2) appropriate knowledge about safety and quality management;
  - (3) knowledge of the aerodrome manual and the organisation's management system manual; and
  - (4) comprehensive knowledge of the applicable requirements in the area of aerodromes, apron management and/or ATS.
- (d) The safety manager should not be the person referred to in point [ADR.OR.F.065\(a\)\(2\)](#). However, depending on the size of the organisation and the type and complexity of its operations, the safety manager may be the accountable manager, or any other person with an operational role within the organisation, provided that they can act independently of other managers within the organisation, and have direct access to the accountable manager and to the appropriate management level for safety matters.

*[applicable from 20 March 2022]*

## GM1 ADR.OR.F.065(a)(2):(a)(3) Personnel requirements

*ED Decision 2020/021/R*

### COMBINED RESPONSIBILITIES

- (a) As regards the acceptability for a single person to hold more than one post, possibly in combination with the capacity as accountable manager, it depends upon the size of the organisation and the type and complexity of its operations. The two main areas of concern are the allocation of sufficient resources as well as the individual's capacity and competence to fulfil their responsibilities.
- (b) The competence in different areas of responsibility is not different from the competence requirements applicable to persons that hold only one post.
- (c) The complexity of the organisation or of its operations may prevent or limit the combination of posts.

*[applicable from 20 March 2022]*

## AMC1 ADR.OR.F.065(a)(4) Personnel requirements

*ED Decision 2020/021/R*

### DETERMINATION OF PERSONNEL REQUIRED FOR PLANNED TASKS AND PERSONNEL QUALIFICATIONS

The organisation responsible for the provision of AMS should determine:

- (a) the personnel that are required for the planned tasks;
- (b) the required personnel qualifications in accordance with the applicable requirements (and the national and European Union legislation, where applicable), and include them in the management system manual; a documented system with defined responsibilities should be in place to identify any need for changes with regard to personnel qualifications.

*[applicable from 20 March 2022]*

## GM1 ADR.OR.F.065(a)(4) Personnel requirements

*ED Decision 2020/021/R*

### PERSONNEL QUALIFICATIONS

The term ‘qualified’ denotes fit for purpose. This may be achieved through the fulfilment of the necessary conditions, such as the completion of the required training, or the acquisition of a diploma or degree, or by gaining relevant experience. It also includes the competence, capacity, knowledge or skills that match or suit an occasion, or make someone eligible for a duty, office, position, privilege or status.

Certain posts may, by nature, be associated with special qualifications in a specific field (e.g. rescue and firefighting; civil, mechanical or electrical engineering; wildlife biology; etc.). In such cases, the person that occupies such a post is expected to have the necessary qualifications at a level that is in accordance with the applicable national or European Union legislation.

*[applicable from 20 March 2022]*

## ADR.OR.F.075 Use of alcohol, psychoactive substances and medicines

*Delegated Regulation (EU) 2020/1234*

The organisation responsible for the provision of AMS shall implement the procedures established by the aerodrome operator in accordance with point [ADR.OR.C.045](#) with regard to the consumption of alcohol, psychoactive substances and medicines by its personnel involved in the provision of apron management service.

*[applicable from 20 March 2022]*

## ADR.OR.F.080 Record-keeping

*Delegated Regulation (EU) 2020/1234*

- (a) The organisation responsible for the provision of AMS shall establish an adequate record-keeping system that covers all its activities undertaken in accordance with [Regulation \(EU\) 2018/1139](#) and the delegated and implementing acts adopted on the basis thereof.
- (b) The format of the records shall be specified in the management system manual.
- (c) Records shall be stored in a manner that ensures protection from damage, alteration and theft.

- (d) Records shall be kept for a minimum of 5 years, except that:
- (1) the current declaration shall be kept for the lifespan of the declaration;
  - (2) written agreements with other organisations shall be kept for as long as such agreements are in effect;
  - (3) safety assessment reports shall be kept for the lifetime of the system, procedure or activity;
  - (4) personnel training, qualifications, as well as their proficiency checks shall be kept for at least 4 years after the end of their employment, or until the area of their employment has been audited by the Competent Authority;
- (e) The organisation responsible for the provision of AMS shall establish and maintain a hazard register.

*[applicable from 20 March 2022]*

## AMC1 ADR.OR.F.080 Record keeping

*ED Decision 2020/021/R*

### DOCUMENTATION TO BE RETAINED

- (a) The record-keeping system used by the organisation responsible for the provision of AMS should provide for adequate procedures, storage facilities, as well as the reliable traceability, retrievability and accessibility of the records related to its activities that are subject to [Regulation \(EU\) 2018/1139](#) and its delegated and implementing acts throughout the required retention period.
- (b) The records should be kept in paper or electronic format, or a combination of both. It is also acceptable to keep records stored in microfilms or optical discs. The records should remain legible throughout the required retention period. The retention period starts when the record is created or last amended.
- (c) For paper-based systems, robust material should be used which can withstand normal handling and filing.
- (d) Electronic systems should have at least one backup system which should be updated every 24 hours or each time a new entry is made. Electronic systems should include safeguards against the possibility for unauthorised personnel to alter the data.
- (e) All computer hardware used to ensure data backup should be stored in a location different from that containing the working data, and in an environment that ensures they remain in good condition. When hardware or software changes take place, special care should be taken that all necessary data continues to be accessible, at least throughout the retention period. In the absence of any indication of the retention period, all records should be kept for a minimum period of 5 years.

*[applicable from 20 March 2022]*



## GM1 ADR.OR.F.080 Record keeping

*ED Decision 2020/021/R*

### RECORDS

The microfilming of the records or their optical storage may be carried out at any time. The copies of the records need to be as legible as the original records and remain legible for the required retention period.

*[applicable from 20 March 2022]*

## ADR.OR.F.085 Formal arrangement between the organisation responsible for the provision of AMS and the aerodrome operator

*Delegated Regulation (EU) 2020/1234*

- (a) The organisation responsible for the provision of AMS shall have a formal arrangement with the operator of the aerodrome where it intends to provide apron management service.
- (b) The arrangement shall be concluded prior to the start of the provision of the service.
- (c) The formal arrangement shall include as a minimum the following:
  - (1) duration of the arrangement;
  - (2) definition of the area where apron management service will be provided;
  - (3) list of the services that will be conducted by the organisation responsible for the provision of AMS;
  - (4) methods of exchanging operational information between the aerodrome operator and the organisation responsible for the provision of AMS.

*[applicable from 20 March 2022]*

## ADR.OR.F.090 Formal arrangement between the organisation responsible for the provision of AMS and the air traffic service provider

*Delegated Regulation (EU) 2020/1234*

- (a) The organisation responsible for the provision of AMS shall have a formal arrangement with the air traffic service provider of the aerodrome where it intends to provide apron management service.
- (b) The arrangement shall be concluded prior to the start of the provision of the service.
- (c) The formal arrangement shall include as a minimum the following:
  - (1) duration of the arrangement;
  - (2) scope of services to be provided, including coordination of start-up clearances, taxi and push-back of aircraft;
  - (3) handover points between apron management service and air traffic service provider;
  - (4) methods of exchanging operational information between the air traffic service provider and the organisation responsible for the provision of AMS;

- (5) coordination of start-up clearances, taxi and push-back of aircraft.

*[applicable from 20 March 2022]*

## ADR.OR.F.095 Management system manual

*Delegated Regulation (EU) 2020/1234*

- (a) The organisation responsible for the provision of AMS shall:
- (1) establish and maintain a management system manual;
  - (2) ensure that its personnel have easy access to the manual and are made aware of any changes;
  - (3) after consultation and in coordination with the aerodrome operator, supply the Competent Authority with the intended amendments and revisions of the manual in advance of the effective date;
  - (4) review the content of the manual, ensure that it is kept up to date and amended, whenever necessary;
  - (5) incorporate all amendments and revisions to the manual as required by the Competent Authority;
  - (6) make other organisations concerned aware of the changes that are relevant to their duties.
  - (7) ensure that any information taken from other approved documents, and any amendment thereof, is correctly reflected in the manual;
  - (8) ensure that the manual is written in a language acceptable to the Competent Authority;
  - (9) ensure that all personnel are able to read and understand the language in which those parts of the manual and other documents pertaining to their duties and responsibilities are written;
  - (10) ensure that the manual is signed by the accountable manager of the organisation;
  - (11) ensure that the manual is printed or is in electronic format and is easy to revise;
  - (12) ensure that the manual has a system for version control management which is applied and made visible in the manual;
  - (13) ensure that the manual observes human factors principles and is organised in a manner that facilitates its preparation, use and review;
  - (14) keep at least one complete and current copy of the manual at the aerodrome where it provides service, and make it available for inspection by the Competent Authority.
- (b) The content of the manual shall be structured as follows:
- (1) general part;
  - (2) organisation's management system and qualification requirements.
- (c) In the case that the aerodrome operator or the air traffic service provider are partially or exclusively providing apron management service, they shall ensure that the relevant requirements in point (b) are included in the aerodrome manual or the air traffic service operations manual respectively.

[applicable from 20 March 2022]

## AMC1 ADR.OR.F.095 Management system manual

ED Decision 2020/021/R

### GENERAL

- (a) The management system manual may vary in terms of level of detail according to the complexity and the size of the organisation.
- (b) The management system manual or parts of it may be presented in any form, including the electronic form. In all cases, the accessibility, usability and reliability of the management system manual should be ensured.
- (c) The management system manual should be developed such that:
  - (1) all its parts are consistent and compatible in terms of content and format;
  - (2) it can be readily amended; and
  - (3) its content and amendment status are controlled and clearly indicated.
- (d) The management system manual should include a description of its amendment and revision process specifying:
  - (1) the person(s) that may approve amendments or revisions;
  - (2) the conditions for temporary revisions and/or immediate amendments, or revision(s) required in the interest of safety; and
  - (3) the methods by which all personnel and organisations are advised of the changes made to it.
- (e) The management system manual may contain parts of, or refer to, other controlled documents, which are available in the organisation for use by its personnel.

[applicable from 20 March 2022]

## AMC2 ADR.OR.F.095 Management system manual

ED Decision 2020/021/R

### CONTENT AND STRUCTURE

- (a) The management system manual should have the following structure and should include, at least, the following information (*if an item is not applicable, 'Not applicable' or 'Intentionally left blank' should be indicated, along with the relevant justification*):
  - A PART A — GENERAL
    - 0. Administration and control of the management system manual, including the following:
      - 0.1. Introduction:
        - 0.1.1. a statement, signed by the accountable manager, declaring that the management system manual complies with the applicable requirements and the content of the declaration;

- 
- 0.1.2. a list and brief description of the various parts, their contents, applicability and use; and
  - 0.1.3. explanations, abbreviations and definitions of terms required for the use of the management system manual.
  - 0.2. System for amendments and revisions:
    - 0.2.1. details of the person(s) responsible for the issue and insertion of amendments and revisions;
    - 0.2.2. a record of the amendments and revisions with insertion dates and effective dates;
    - 0.2.3. a statement that handwritten amendments and revisions are not permitted;
    - 0.2.4. a description of the system for the annotation of pages or paragraphs and their effective dates;
    - 0.2.5. a list of effective pages or paragraphs;
    - 0.2.6. annotation of changes (in the text and, as far as practicable, in diagrams); and
    - 0.2.7. description of the distribution system and a distribution list for the management system manual, its amendments and its revisions.
  - 1. General information
    - General information, including the following:
      - 1.1. purpose and scope of the management system manual;
      - 1.2. the legal requirements for an organisation responsible for the provision of AMS to submit to the Competent Authority a declaration and a management system manual as prescribed in Part-ADR.OR; and
      - 1.3. the obligations of the organisation responsible for the provision of AMS, the rights of the Competent Authority, and guidance for the personnel of the organisation responsible for the provision of AMS on how to facilitate audits/inspections conducted by the Competent Authority personnel.
- B. PART B — MANAGEMENT SYSTEM, AMS PERSONNEL QUALIFICATIONS AND TRAINING REQUIREMENTS**
- 2. A description of the management system, including the following:
    - 2.1. Organisational structure and responsibilities, including the following: a description of the organisational structure, including the general organogram and the departments' organograms. The organogram should depict the relationship between the departments. Subordination and reporting lines of all levels of the organisational structure (departments, sections, etc.) related to safety should be shown.

Names, authority, responsibilities and duties of management, nominated persons, operational staff and safety committees should also be included.

- 
- 2.2. A description of the safety management system, including:
    - 2.2.1. the scope of the safety management system;
    - 2.2.2. the safety policy and its objectives;
    - 2.2.3. the safety responsibilities of key safety personnel;
    - 2.2.4. the documentation control procedures;
    - 2.2.5. the safety risk management process, including hazard identification and risk assessment schemes;
    - 2.2.6. monitoring of the implementation and the effectiveness of the safety actions and risk-mitigation measures;
    - 2.2.7. safety performance monitoring;
    - 2.2.8. safety reporting (including hazard reporting) and investigation;
    - 2.2.9. change management (including organisational changes with regard to safety responsibilities);
    - 2.2.10. safety promotion; and
    - 2.2.11. safety management system outputs.
  - 2.3. A description of compliance monitoring and the related procedures.
  - 2.4. Procedures for reporting to the Competent Authority and the aerodrome operator, including procedures for handling, notifying and reporting accidents, serious incidents and occurrences. This section should include, at least, the following:
    - 2.4.1. the definition of ‘accident’, ‘serious incident’ and ‘occurrence’, as well as the definition of the relevant responsibilities for all persons involved;
    - 2.4.2. illustrations of the forms (or copies of the forms) to be used, instructions on how they are to be completed, the addresses (postal or electronic) to which they should be sent, and the time allowed for this to be done; and
    - 2.4.3. procedures and arrangements for retaining evidence, including recordings, following a reportable event.
  - 2.5. Procedures related to the use of alcohol, psychoactive substances and medicines by personnel involved in the provision of AMS.
  - 2.6. Procedures with regard to:
    - 2.6.1. compliance with safety directives;
    - 2.6.2. reaction to safety problems; and
    - 2.6.3. the handling of safety recommendations issued by safety investigation authorities.
  3. Required qualifications and responsibilities for AMS personnel.

*[applicable from 20 March 2022]*

## GM1 ADR.OR.F.095 Management system manual

ED Decision 2020/021/R

### MANAGEMENT SYSTEM MANUAL

(a) Form of the manual

The management system manual is a key document both for the organisation responsible for the provision of AMS and the Competent Authority. The manual should reflect accurately the day-to-day functioning of the organisation's safety management system and safety culture. It will need to show how the organisation intends to measure its performance against the safety targets and objectives. The reader or the user of the manual should be given a clear statement of how safety is developed, managed and maintained in the organisation. All safety policies and instructions should be presented in detail and, when relevant, cross-referenced to other controlled, formally accepted or recognised publications.

(b) Purpose of the manual

The manual contains all the relevant information to describe the management system structure satisfactorily. It is one of the means by which all relevant operational staff can be informed about their duties and responsibilities with regard to safety.

Accountability for safety must start at the very top of the organisation. One of the key elements in establishing safe working practices is the 'top-down' approach where all staff understand the safety objectives of the organisation, the chain of command and their own responsibilities and accountabilities within the organisation. As safety management principles are applied, the manual is expanded to describe clearly how the safety of operations is to be managed. The user of the manual should never be in any doubt in terms of 'safety accountability' for each domain or activity described. Each section should define who is accountable, who is responsible, who has the authority, who has the expertise, and who actually carries out the tasks described in any of the sections.

The principal objective of the manual should be to show how management will fulfil its safety responsibilities. The manual will set out the policy and the expected standards of performance, and the procedures by which they will be achieved.

*[applicable from 20 March 2022]*

## GM2 ADR.OR.F.095 Management system manual

ED Decision 2020/021/R

### CONTENTS AND STRUCTURE

The numbering system described in [AMC2 ADR.OR.F.095](#) may be maintained even if there are sections that are not applicable.

*[applicable from 20 March 2022]*

## AMC1 ADR.OR.F.095(g)(1) Management system manual

ED Decision 2020/021/R

### LANGUAGE OF THE MANUAL

A translated version of the relevant parts of the manual is an acceptable means to comply with the relevant requirement. In any case, the persons that are going to use the manual, should be able to read and understand it.

---

*[applicable from 20 March 2022]*

## ADR.OR.F.100 Documentation requirements

*Delegated Regulation (EU) 2020/1234*

The organisation responsible for the provision of AMS shall:

- (a) make available the parts of the aerodrome manual related to the provision of apron management service to its operational personnel;
- (b) make available of any other documentation required by the Competent Authority and associated amendments;
- (c) disseminate operational instructions and other information without delay.

*[applicable from 20 March 2022]*

## ANNEX IV — PART-ADR.OPS

### PART OPERATIONS REQUIREMENTS — AERODROMES

### SUBPART A — AERODROME DATA (ADR.OPS.A)

#### ADR.OPS.A.005 Aerodrome data

*Regulation (EU) No 139/2014*

The aerodrome operator shall as appropriate:

- (a) determine, document and maintain data relevant to the aerodrome and available services;
- (b) provide data relevant to the aerodrome and available services to the users and the relevant air traffic services and aeronautical information services providers.

#### AMC1 ADR.OPS.A.005 Aerodrome data

*ED Decision 2014/012/R*

- (a) Data relevant to the aerodrome and available services should include, but may not be limited to, items in the following list:
  - (1) aerodrome reference point;
  - (2) aerodrome and runway elevations;
  - (3) aerodrome reference temperature;
  - (4) aerodrome dimensions and related information;
  - (5) strength of pavements;
  - (6) pre-flight altimeter check location;
  - (7) declared distances;
  - (8) condition of the movement area and related facilities;
  - (9) disabled aircraft removal;
  - (10) rescue and firefighting; and
  - (11) visual approach slope indicator systems.
- (b) The aerodrome operator should measure and report to the aeronautical information services obstacles and terrain data in Area 3, and in Area 2 (the part within the aerodrome boundary) in degrees, minutes, seconds and tenths of seconds. In addition, the top elevation, type, marking and lighting (if any) of obstacles should be reported to the aeronautical information services.
- (c) Electronic obstacle data for all obstacles in Area 2 (the part within the aerodrome boundary) that are assessed as being a hazard to air navigation should be provided.
- (d) Electronic terrain and obstacle data should be provided for:
  - (1) Area 2a, for those that penetrate the relevant obstacle data collection surface;
  - (2) penetrations of the take-off flight path area obstacle identification surfaces; and
  - (3) penetrations of the aerodrome obstacle limitation surfaces.



- (e) Electronic terrain and obstacle data should be provided for Area 4 for terrain and obstacles that penetrate the relevant obstacle data collection surface, for all runways where precision approach Category II or III operations have been established and where detailed terrain information is required by operators to enable them to assess the effect of terrain on decision height determination by use of radio altimeters.
- (f) The aerodrome operator should establish arrangements with the Air Traffic Services providers and the Competent Authority for the provision of obstacles and terrain data outside of the aerodrome boundary.

## **GM1 ADR.OPS.A.005 Aerodrome data**

*ED Decision 2017/017/R*

### **AERODROME REFERENCE POINT**

- (a) The aerodrome reference point should be located near the initial or planned geometric centre of the aerodrome and normally should remain where first established.
- (b) The aerodrome reference point should be measured and reported to the aeronautical information services in degrees, minutes, and seconds.

### **AERODROME AND RUNWAY ELEVATIONS**

The following should be measured and reported to the aeronautical information services:

- (a) The aerodrome elevation and geoid undulation at the aerodrome elevation position to the accuracy of one-half metre or foot;
- (b) For non-precision approaches, the elevation and geoid undulation of each threshold, the elevation of the runway end and any significant high and low intermediate points along the runway, to the accuracy of one-half metre or foot;
- (c) For precision approach runway, the elevation and geoid undulation of the threshold, the elevation of the runway end and the highest elevation of the touchdown zone, to the accuracy of one-quarter metre or foot.

### **AERODROME REFERENCE TEMPERATURE**

- (a) The aerodrome reference temperature should be determined in degrees Celsius.
- (b) The aerodrome reference temperature should be the monthly mean of the daily maximum temperatures for the hottest month of the year (the hottest month being that which has the highest monthly mean temperature), averaged over a period of five (5) years.

### **AERODROME DIMENSIONS AND RELATED INFORMATION**

The following data are measured or described, as appropriate, for each facility provided on the aerodrome:

- (a) Runway
  - (1) true bearing to one-hundredth of a degree;
  - (2) designation number;
  - (3) length;
  - (4) width;
  - (5) displaced threshold location to the nearest metre or foot;

- (6) longitudinal slope;
  - (7) surface type;
  - (8) type of runway; and
  - (9) for a precision approach runway category I, the existence of an obstacle free zone when provided.
- (b) Strip/Runway End Safety Area/Stopway
- (1) Length, width to the nearest metre or foot;
  - (2) Surface type; and
  - (3) Arresting system – location (which runway end) and description.
- (c) Taxiway
- (1) Designation;
  - (2) Width; and
  - (3) Surface type.
- (d) Apron
- (1) Surface type; and
  - (2) Aircraft stands.
- (e) The boundaries of the air traffic control service;
- (f) Clearway
- (1) length to the nearest metre or foot; and
  - (2) ground profile.
- (g) Visual aids for approach procedures, marking and lighting of runways, taxiways and aprons, other visual guidance and control aids on taxiways and aprons, including runway holding positions, intermediate holding positions and stopbars, and location and type of visual docking guidance systems;
- (h) Location and radio frequency of any VOR aerodrome checkpoint;
- (i) Location and designation of standard taxi-routes;
- (j) Distances to the nearest metre or foot of localiser and glide path elements comprising an instrument landing system (ILS) or azimuth and elevation antenna of a microwave landing system (MLS) in relation to the associated runway extremities;
- (k) The geographical coordinates of:
- (1) each threshold;
  - (2) appropriate taxiway centre line points; and
  - (3) each aircraft stand;
- are measured and reported to the aeronautical information services in degrees, minutes, seconds and hundredths of seconds.

**STRENGTH OF PAVEMENTS**

- (a) The bearing strength of a pavement intended for aircraft of apron (ramp) mass greater than 5 700 kg should be made available using the aircraft classification — pavement classification number (ACN–PCN) method, by reporting all of the following information:
- (1) the pavement classification number (PCN);
  - (2) pavement type for ACN-PCN determination;
  - (3) subgrade strength category;
  - (4) maximum allowable tire pressure category or maximum allowable tire pressure value; and
  - (5) evaluation method.
- (b) For the purposes of determining the ACN, the behaviour of a pavement should be classified as equivalent to a rigid or flexible construction;
- (c) Information on pavement type for ACN-PCN determination, subgrade strength category, maximum allowable tire pressure category and evaluation method, should be reported using the following codes:
- (1) Pavement type for ACN-PCN determination:
    - (i) Rigid pavement: Code R;
    - (ii) Flexible pavement: Code F;
  - (2) Subgrade strength category:
    - (i) High strength: characterised by  $K = 150 \text{ MN/m}^3$  and representing all  $K$  values above  $120 \text{ MN/m}^3$  for rigid pavements, and by  $\text{CBR} = 15$  and representing all  $\text{CBR}$  values above 13 for flexible pavements — Code A;
    - (ii) Medium strength: characterised by  $K = 80 \text{ MN/m}^3$  and representing a range in  $K$  of 60 to  $120 \text{ MN/m}^3$  for rigid pavements, and by  $\text{CBR} = 10$  and representing a range in  $\text{CBR}$  of 8 to 13 for flexible pavements — Code B;
    - (iii) Low strength: characterised by  $K = 40 \text{ MN/m}^3$  and representing a range in  $K$  of 25 to  $60 \text{ MN/m}^3$  for rigid pavements, and by  $\text{CBR} = 6$  and representing a range in  $\text{CBR}$  of 4 to 8 for flexible pavements — Code C;
    - (iv) Ultra low strength: characterised by  $K = 20 \text{ MN/m}^3$  and representing all  $K$  values below  $25 \text{ MN/m}^3$  for rigid pavements, and by  $\text{CBR} = 3$  and representing all  $\text{CBR}$  values below 4 for flexible pavements — Code D;
  - (3) Maximum allowable tire pressure category:
    - (i) Unlimited: no pressure limit — Code W;
    - (ii) High: pressure limited to 1.75 MPa — Code X;
    - (iii) Medium: pressure limited to 1.25 MPa — Code Y;
    - (iv) Low: pressure limited to 0.50 MPa — Code Z;
  - (4) Evaluation method:
    - (i) Technical evaluation: representing a specific study of the pavement characteristics and application of pavement behaviour technology — Code T;

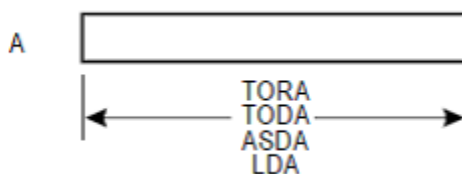
- (ii) Using aircraft experience: representing a knowledge of the specific type and mass of aircraft satisfactorily being supported under regular use — Code U;
- (d) The bearing strength of a pavement intended for aircraft of apron (ramp) mass equal to or less than 5 700 kg, should be reported by reporting the following information:
  - (1) maximum allowable aircraft mass; and
  - (2) maximum allowable tire pressure.

#### PRE-FLIGHT ALTIMETER CHECK LOCATION

- (a) One or more pre-flight altimeter check locations should be established.
- (b) The elevation of a pre-flight altimeter check location should be given as the average elevation, rounded to the nearest metre or foot, of the area on which it is located. The elevation of any portion of a pre-flight altimeter check location should be within 3 m (10 ft) of the average elevation for that location.
- (c) Pre-flight check location could be located on an apron. Locating a pre-flight altimeter check location on an apron enables an altimeter check to be made prior to obtaining taxi clearance and eliminates the need for stopping for that purpose after leaving the apron. Normally an entire apron could serve as a satisfactory altimeter check location.

#### DECLARED DISTANCES

- (a) The following distances should be calculated to the nearest metre or foot for a runway and reported to the aeronautical information services and Air Traffic Services:
  - (1) Take-off run available (TORA);
  - (2) Take-off distance available (TODA);
  - (3) Accelerate stop distance available (ASDA); and
  - (4) Landing distance available (LDA).
- (b) The take-off run available (TORA), take-off distance available (TODA), accelerate stop distance available (ASDA) and landing distance available (LDA) should be calculated according to the following (all declared distances are illustrated for operations from left to right):
  - (1) Where a runway is not provided with a stopway or a clearway and the threshold is located at the extremity of the runway, the four declared distances should normally be equal to the length of the runway



**Figure 1**

- (2) When a runway is provided with a clearway (CWY), then the TODA will include the length of clearway.

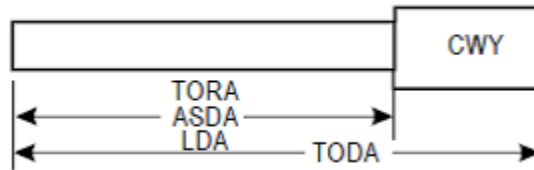


Figure 2

- (3) Where a runway is provided with a stopway (SWY), then the ASDA will include the length of stopway.

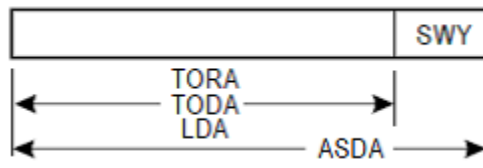


Figure 3

- (4) Where a runway has a displaced threshold, then the LDA will be reduced by the distance the threshold is displaced. A displaced threshold affects only the LDA for approaches made to that threshold; all declared distances for operations in the reciprocal direction are unaffected.

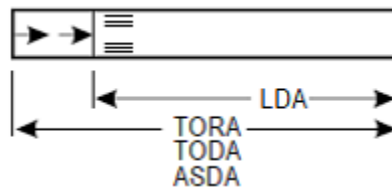


Figure 4

- (5) Where a runway is provided with more than one of the clearway, stopway, or having a displaced threshold, then more than one of the declared distances will be modified. The modification will follow the same principle as in (1)–(4)

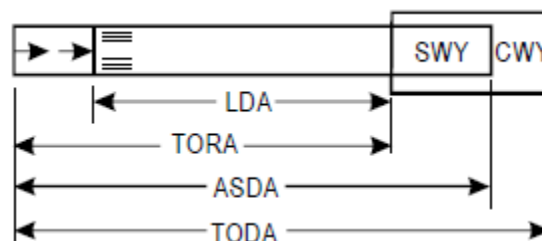


Figure 5

- (c) The information on declared distances should be provided according to the following table:

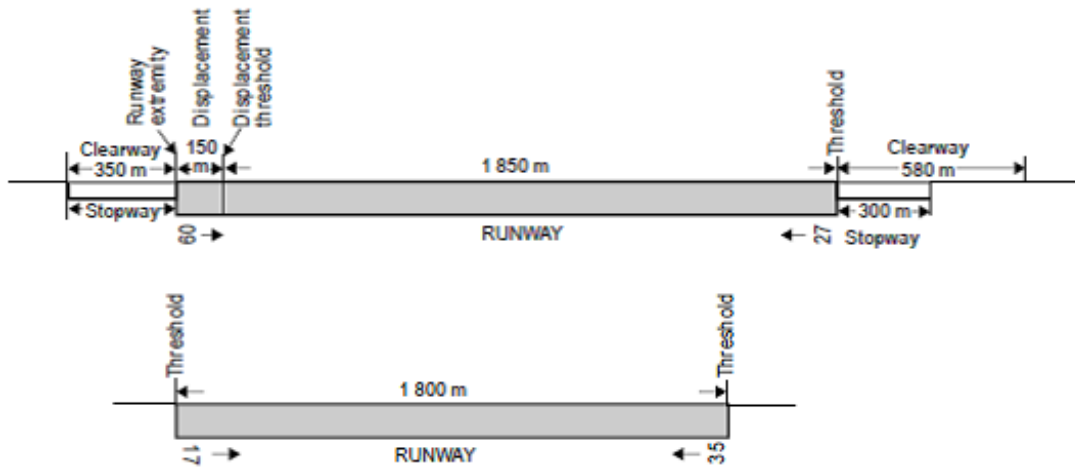


Figure 6

RUNWAY	TORA	ASDA	TODA	LDA
	m	m	m	m
09	2 000	2 300	2 580	1 850
27	2 000	2 350	2 350	2 000
17	NU	NU	NU	1 800
35	1 800	1 800	1 800	NU

Table 1

If a runway direction cannot be used for take-off or landing, or both because it is operationally forbidden, then this should be declared and the words 'not usable' or the abbreviation 'NU' entered.

- (d) When intersection take-offs are performed, the datum line from which the reduced runway declared distances for take-off are determined, should be defined by the intersection of the downwind edge as shown in the figure below:

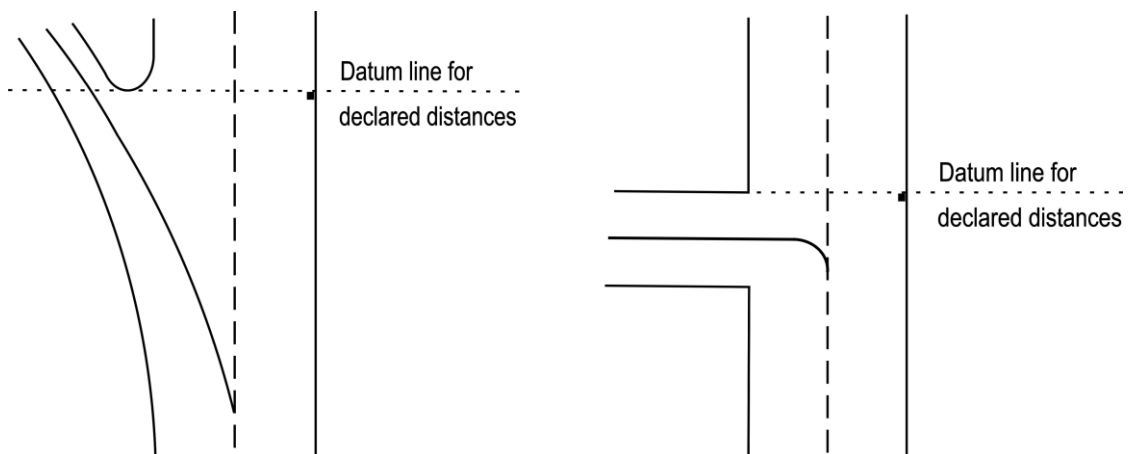


Figure 7

## CONDITION OF THE MOVEMENT AREA AND RELATED FACILITIES

The condition of the movement area and the operational status of related facilities should be monitored and reported, on matters of operational significance affecting aircraft and aerodrome operations, particularly in respect of the following:

- (a) construction or maintenance work;
- (b) rough or broken surfaces on a runway, a taxiway or an apron;
- (c) snow, slush, ice, or frost on a runway, a taxiway or an apron;
- (d) water on a runway, a taxiway or an apron;
- (e) snow banks or drifts adjacent to a runway, a taxiway or an apron;
- (f) anti-icing or de-icing liquid chemicals or other contaminants on a runway, taxiway or apron;
- (g) other temporary hazards, including parked aircraft;
- (h) failure or irregular operation of part or all of the aerodrome visual aids; and
- (i) failure of the normal or secondary power supply.

### Water on a runway

Whenever water is present on a runway, a description of the runway surface should be made available using the following terms:

- (a) **DAMP** — the surface shows a change of colour due to moisture;
- (b) **WET** — the surface is soaked but there is no standing water;
- (c) **STANDING WATER** — for aeroplane performance purposes, a runway where more than 25 per cent of the runway surface area (whether in isolated areas or not) within the required length and width being used is covered by water more than 3 mm deep.

Information that a runway or portion thereof maybe slippery when wet, should be made available to the aerodrome users.

### Snow, slush or ice or frost on a runway

- (a) Whenever an operational runway is contaminated by snow, slush, ice or frost, the runway surface condition should be assessed and reported. Runway condition assessment should be repeated as conditions change.
- (b) The contaminant type, distribution, and for loose contaminants, depth for each third of the runway, should be assessed. An indication of surface friction characteristics is helpful in conducting runway condition assessment however caution should be exercised when correlating the results obtained by friction measuring equipment with aircraft performance. Additionally, for contaminants such as slush, wet snow and wet ice, contaminant drag on the equipment's measuring wheel, amongst other factors, may cause readings obtained in these conditions to be unreliable.
- (c) Assessment of the friction of a runway should be made in descriptive terms of 'estimated surface friction'. The estimated surface friction should be categorised as good, medium to good, medium, medium to poor, and poor, and promulgated in SNOWTAM format as well as using appropriate RTF phraseologies.
- (d) The estimated surface friction, based on the measured coefficient, when the runway is covered by compacted snow or ice only, could be reported according to the following table (indicative),

although these values may vary due to the friction measuring device as well as to the surface being measured and the speed employed:

Measured Coefficient ( $\mu$ )	Estimated surface friction	Code
0.40 and above	Good	5
0.39 to 0.36	Medium to good	4
0.35 to 0.30	Medium	3
0.29 to 0.26	Medium to poor	2
0.25 and below	Poor	1

**Table 2**

- (e) Assessed surface condition information, including estimated surface friction, should be reported for each third of a runway. The thirds are called A, B and C;
- (1) For the purpose of reporting information to aeronautical service units, Section A should always be the section associated with the lower runway designation number;
  - (2) When giving landing information to a pilot before landing, the sections should be referred to as first, second or third part of the runway. The first part should always mean the first third of the runway as seen in the direction of landing;
  - (3) Assessments should be made along two lines parallel to the runway, i.e. along a line on each side of the centreline approximately 3 m, or that distance from the centreline at which most operations take place. The objective of the assessment is to determine the type, depth and coverage of the contaminants and its effect on estimated surface friction given the prevailing weather conditions for sections A, B and C;
  - (4) In cases where a continuous friction measuring device is used, the mean values are obtained from the friction values recorded for each section;
- (f) Whenever dry snow, wet snow, slush ice or frost is present and reported, the description of the runway surface condition should use the following terms:
- (1) dry snow;
  - (2) wet snow;
  - (3) compacted snow;
  - (4) wet compacted snow;
  - (5) slush;
  - (6) ice;
  - (7) wet ice;
  - (8) frost;
  - (9) dry snow on ice;
  - (10) wet snow on ice;
  - (11) chemically treated;
  - (12) sanded; and
- should include, where applicable, the assessment of contaminant depth.

*[applicable until 11 August 2021]*



### CONDITION OF THE MOVEMENT AREA AND RELATED FACILITIES

The condition of the movement area and the operational status of related facilities need to be monitored and reported, on matters of operational significance affecting aircraft and aerodrome operations, particularly in respect of the following:

- (a) construction or maintenance work;
- (b) rough or broken surfaces on a runway, a taxiway or an apron;
- (c) other temporary hazards, including parked aircraft;
- (d) failure or irregular operation of part or all the aerodrome visual aids; and
- (e) failure of the normal or secondary power supply.

*[applicable from 12 August 2021 — ED Decision 2021/003/R]*

### DISABLED AIRCRAFT REMOVAL

- (a) The contact details (telephone/telex number(s), email address, etc.) of the office of the aerodrome coordinator of operations for the removal of an aircraft disabled on or adjacent to the movement area should be made available on request to aircraft operators.
- (b) Information concerning the capability to remove an aircraft disabled on or adjacent to the movement area should be made available.
- (c) The capability to remove a disabled aircraft may be expressed in terms of the largest type of aircraft which the aerodrome is equipped to remove.

### RESCUE AND FIREFIGHTING

- (a) Information concerning the level of protection provided at an aerodrome for aircraft rescue and firefighting purposes during the hours of operation should be made available.
- (b) The level of protection normally available at the aerodrome should be expressed in terms of the category of the rescue and firefighting services and in accordance with the types and amounts of extinguishing agents normally available at the aerodrome.
- (c) Changes in the level of protection normally available at the aerodrome for rescue and firefighting should be notified to the appropriate air traffic services units and aeronautical information services units to enable those units to provide the necessary information to arriving and departing aircraft. When such a change has been corrected, the above units should be advised accordingly.
- (d) Changes in the level of protection from that normally available at the aerodrome could result from a change in the availability of extinguishing agents, equipment to deliver the agents or personnel to operate the equipment, etc.
- (e) A change in the level of protection is expressed in terms of the new category of the rescue and firefighting services available at the aerodrome.

### VISUAL APPROACH SLOPE INDICATOR SYSTEMS

The following information concerning a visual approach indicator system is made available:

- (a) associated runway designation number;
- (b) type of system; for a PAPI or APAPI installation, the side of the runway on which the lights are installed, i.e. left or right, is given;

- (c) where the axis of the system is not parallel to the runway centre line, the angle of displacement and the direction of displacement, i.e. left or right, is indicated;
- (d) nominal approach slope angle(s); and
- (e) minimum eye height(s) over the threshold of the on-slope signal(s).

## **GM2 ADR.OPS.A.005(a) Aerodrome data**

*ED Decision 2014/012/R*

### **SURVEYING REQUIREMENTS FOR RUNWAY THRESHOLDS, TAXIWAYS AND AIRCRAFT STANDS**

- (a) Thresholds
  - (1) For surveying purposes, threshold positions must be taken as being at the geometric centre of the runway and at the beginning of the paved surface, i.e. the beginning of that portion of the runway usable for landing. Where thresholds are marked by appropriate threshold markings (e.g. displaced thresholds), these must be taken as the threshold points. Where threshold lighting is surveyed, the locations must be described on the diagram accompanying the report. Where there is no threshold lighting, an appropriate point for survey in accordance with the following figures must be selected.

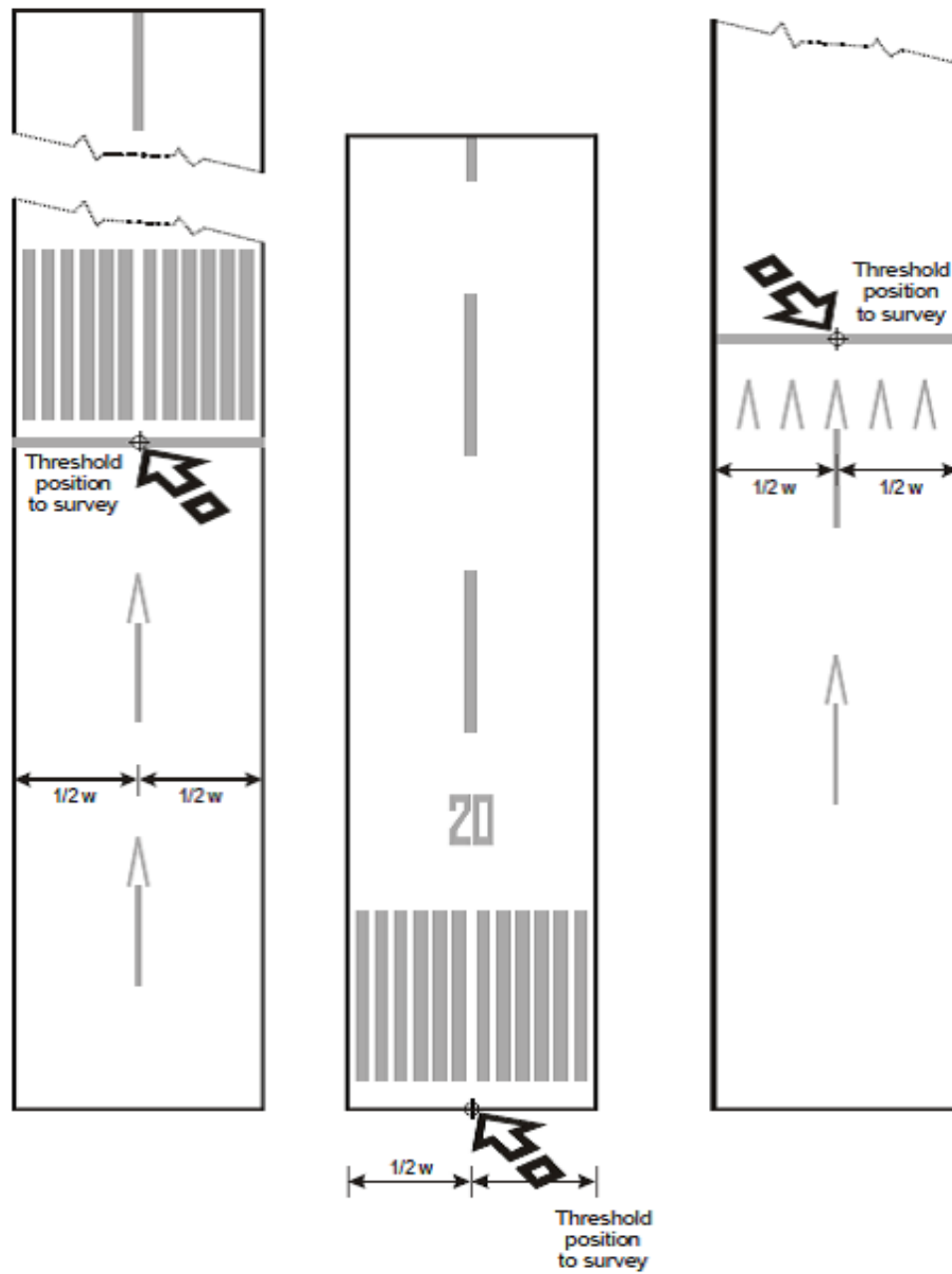
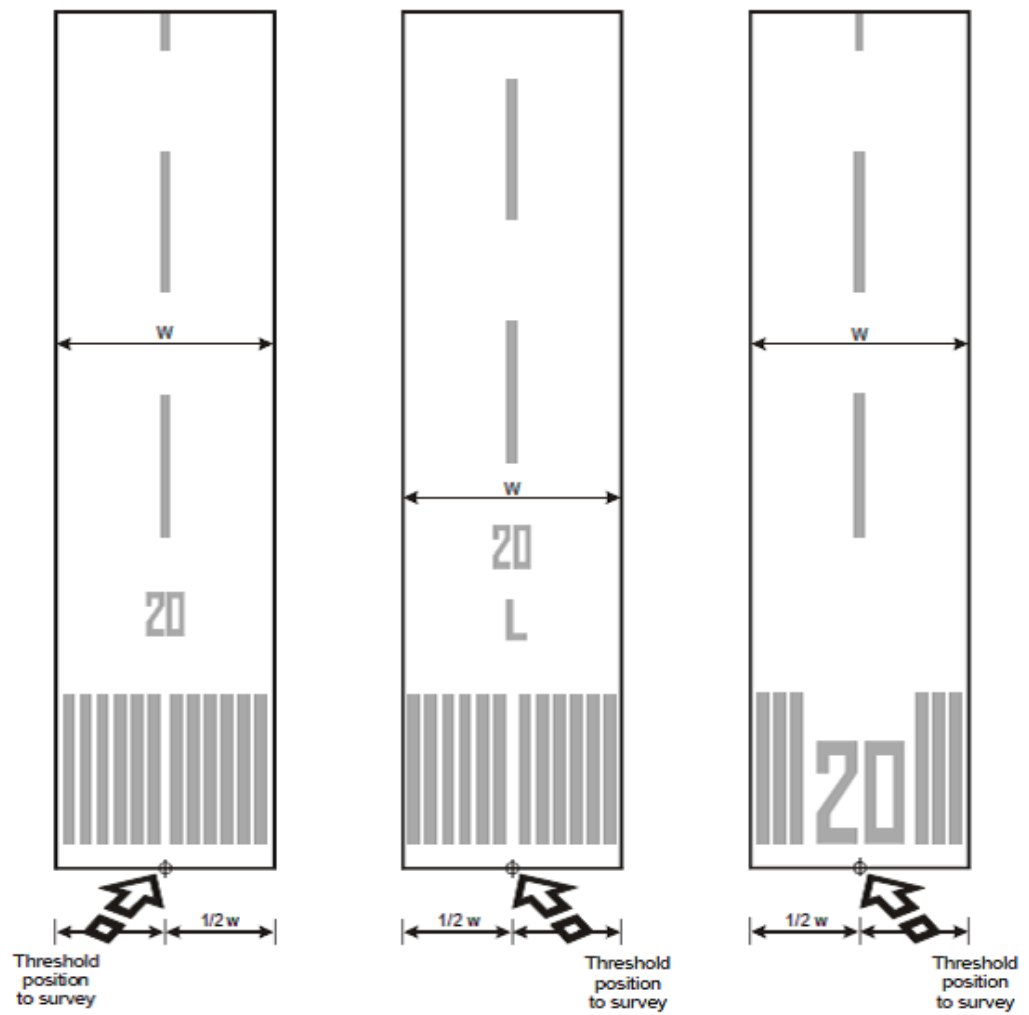
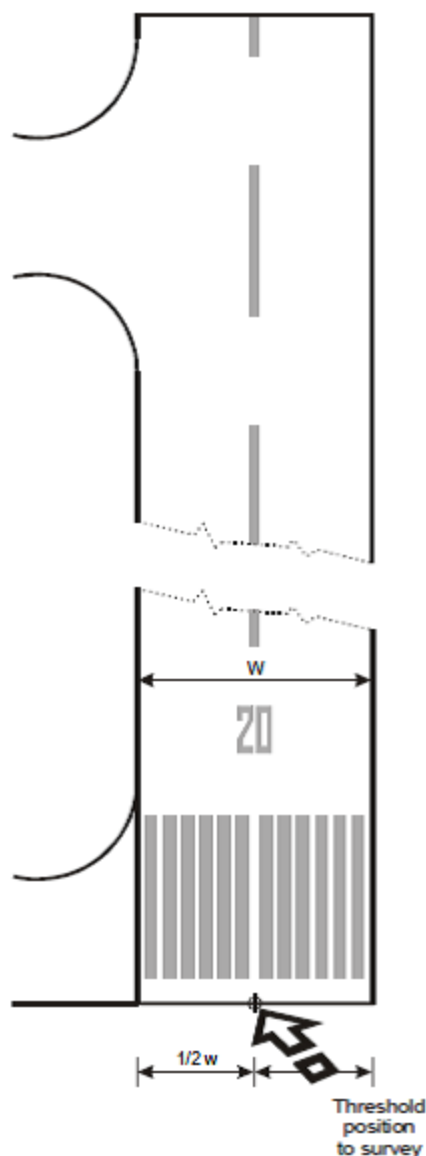


Figure 1



**Figure 2**



**Figure 3**

- (2) If the runway has only one threshold certified for landing, the runway end position must be surveyed. For surveying purposes, the runway end position (flight path alignment point) must be taken as being at the geometric centre of the runway and at the end of the paved surface, i.e. the end of that portion of the runway usable for landing.
- (b) Taxiways and stand/checkpoints — General
- (1) Except as provided in (c) (1) below, for surveying purposes the centre (mid-width) of the taxiway centre line marking, apron taxilane marking or the aircraft stand guide line marking must be taken as the reference data.
  - (2) The points of commencement and ends of straight sections of taxiways, apron taxilanes and aircraft stand point guidance lines markings must be surveyed. Sufficient additional points must be surveyed to maintain the required accuracy along the lines.
  - (3) For curved sections of taxiways, apron taxilanes and aircraft stand guide line markings, the commencement and end of the curved section centre line must be surveyed together

with the position of the centre point of the arc and its radius. In the case of a compound curve, the centre and radius of each arc and the commencement and end of each of the arcs must be surveyed. Where this is impracticable in the field, a series of sequential points must be surveyed along the curved section of the centre line with a maximum arc to chord distance not exceeding 0.25 m for taxiways and 0.10 m for apron taxilanes and aircraft stand guide line markings. Sufficient points must be surveyed to maintain the required accuracy along the lines. The surveyor must, in processing the data, conduct a graphical inspection of the survey points to ensure collinearity.

(c) Taxiways

(1) To permit uninterrupted transition from the actual runway centre line to the taxiway centre line and to provide the required continuity of guidance for the aircraft navigation data base, differentiation must be made between the surface markings and the actual path the aircraft must follow. Therefore, for the guidance of aircraft entering or exiting the runway for take-off or landing, the following must be surveyed:

- (i) the point at which the radius of turn, prescribed by the appropriate authority for each taxiway, is tangential to the runway centre line, and the point at which that radius of turn joins the taxiway centre line marking at a tangent;
- (ii) the point that prescribes the centre of the arc; and
- (iii) the radius of the arc.

Where this is impracticable in the field, a series of sequential points must be surveyed along the curved section of the centre line of taxiways.

(2) Where taxiway centre line marking is provided on a runway that is part of a standard taxi route, or a taxiway centre line is not coincident with runway centre line, the following points must be surveyed:

- (i) the point on the taxiway marking at which the taxiway enters the runway;
- (ii) the points at which the taxiway deviates from a straight line;
- (iii) the intersection of the taxiway centre line marking and boundary of each 'block' that has been published as part of the aerodrome movement and guidance control system; and
- (iv) the point on the taxiway marking at which the taxiway exits the runway.

(3) In defining taxiways, the following points must be surveyed at the centre of the centre line marking of each taxiway, as appropriate:

- (i) intermediate holding positions and runway holding positions (including those associated with the intersection of a runway with another runway when the former runway is part of a standard taxi route) and for points established for the protection of sensitive areas for radio navigation aids;
- (ii) taxiway intersection markings;
- (iii) intersection of other taxiways, including taxiways described in point (c) (2) above;
- (iv) intersections of 'blocks' defined for surface movement, guidance and control systems;

- (v) commencement and end of selectable taxiway lighting systems provided as part of the surface movement, guidance and control systems, where different from subparagraph (iv) above; and
- (d) Aircraft stand points
- (1) In defining the aircraft stands, the following points must be surveyed at the centre of the guide line marking of the aircraft stands, as appropriate:
    - (i) taxilane centre lines;
    - (ii) lead-in line(s);
    - (iii) turning line;
    - (iv) straight section of the turning line;
    - (v) nose wheel stopping position;
    - (vi) true heading of the alignment bar; and
    - (vii) lead-out line(s).
  - (2) Where aircraft stands are utilized by more than one aircraft type and different guide line markings exist, a diagram must be prepared by the surveyor showing the arrangement of the markings in use, together with an indication of the points surveyed. Where all the stands at an aerodrome/heliport are marked uniformly, only a single diagram needs to be prepared.

The points that should be surveyed for a taxiway or an aircraft stand, are shown in the following diagrams:

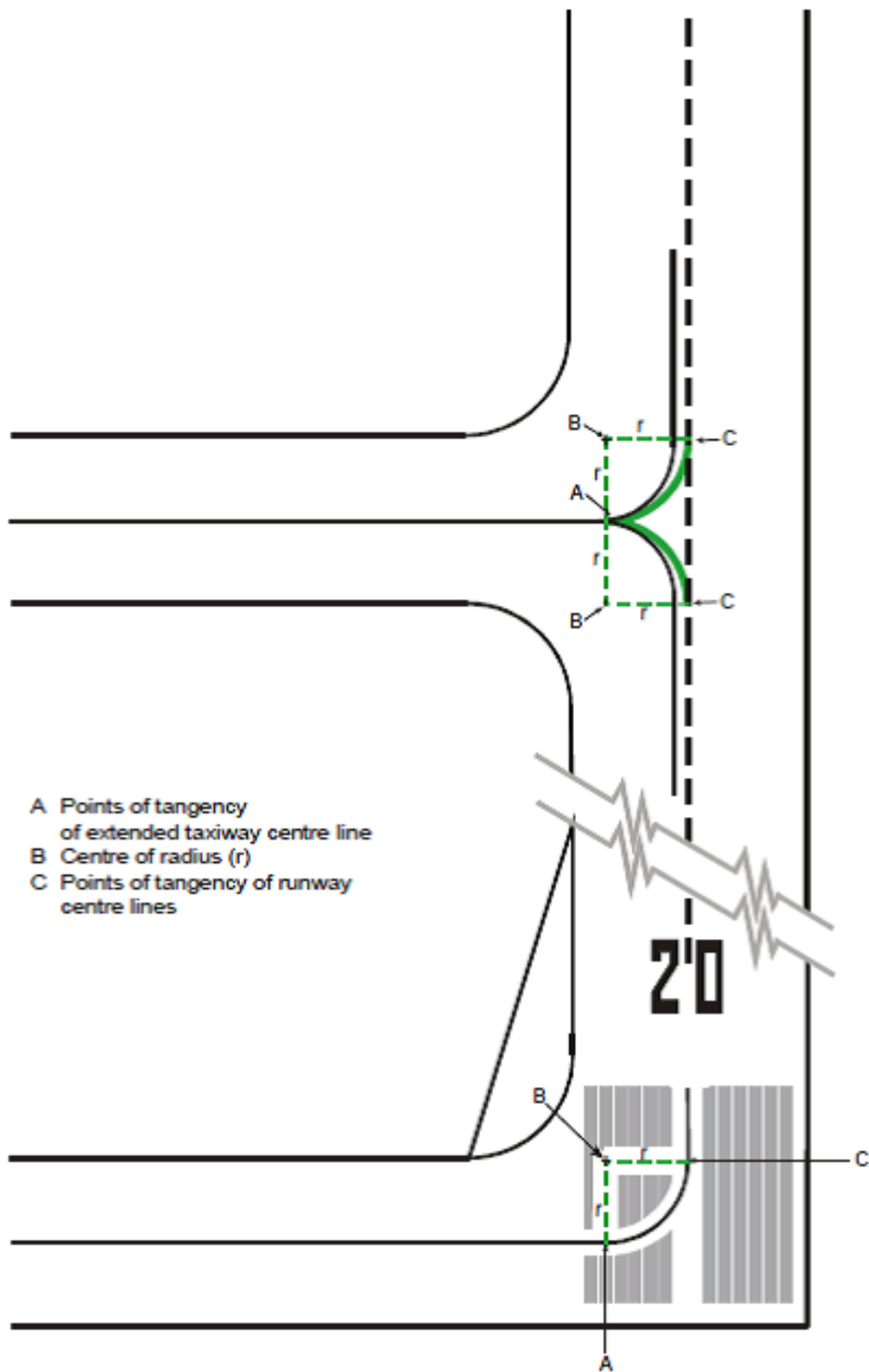


Figure 4 - Runway and taxiway intersections to be surveyed



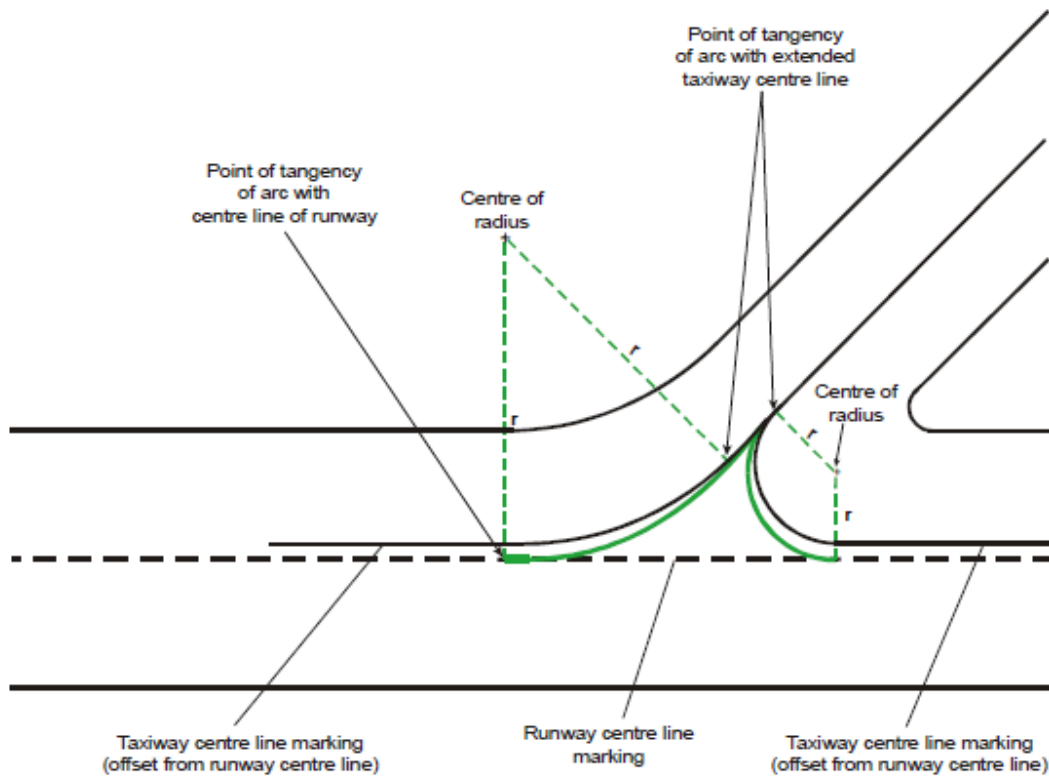


Figure 5 - Runway and taxiway intersections to be surveyed

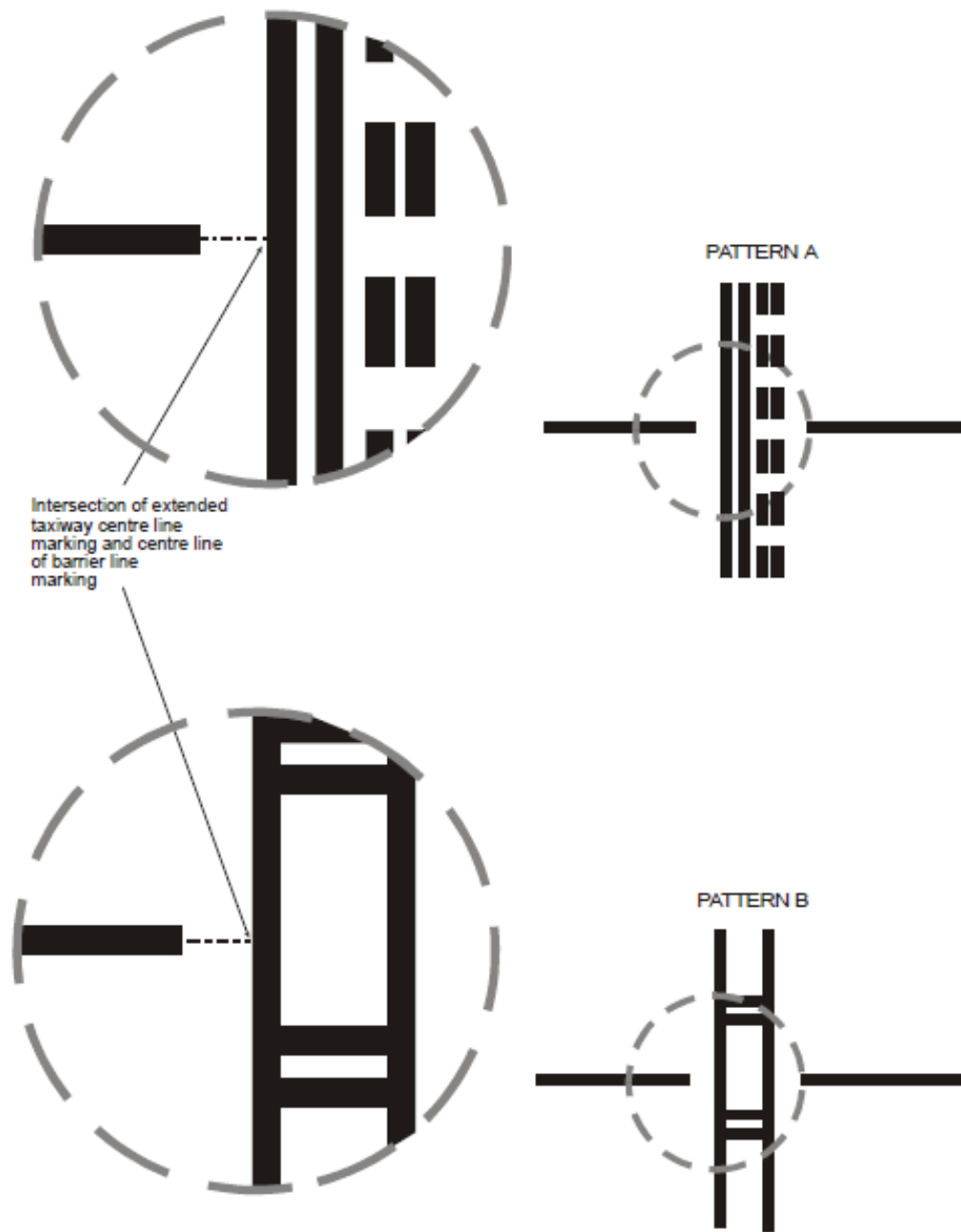


Figure 6 - Runway holding positions to be surveyed

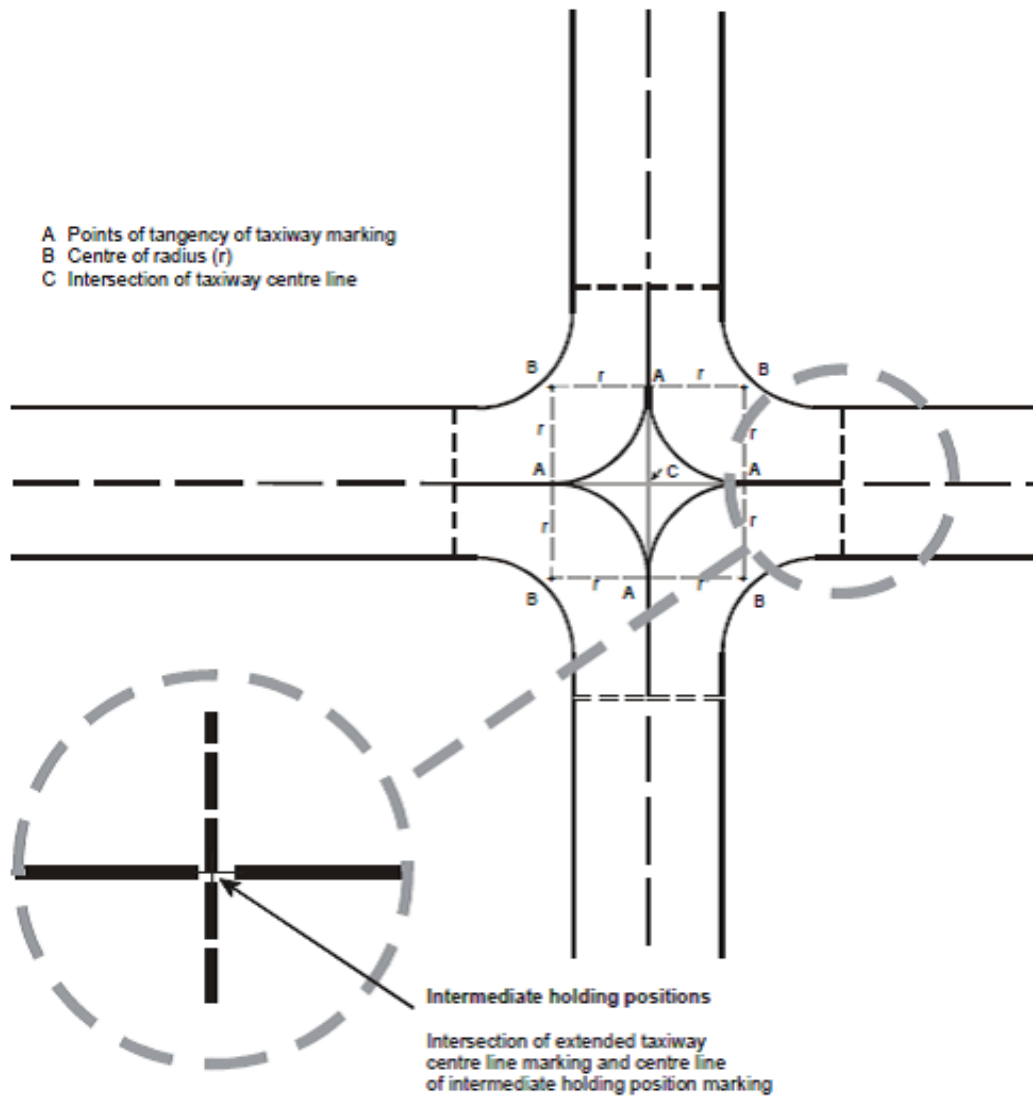
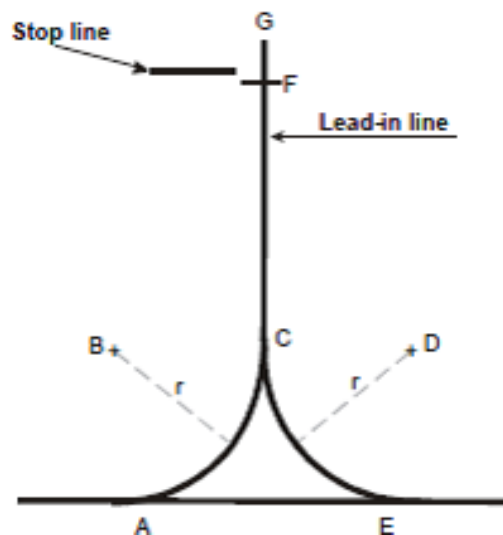
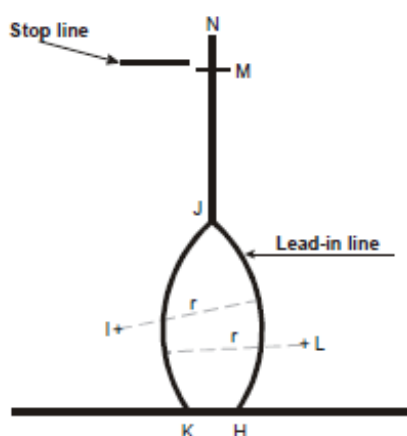


Figure 7 - Taxiway intersections to be surveyed



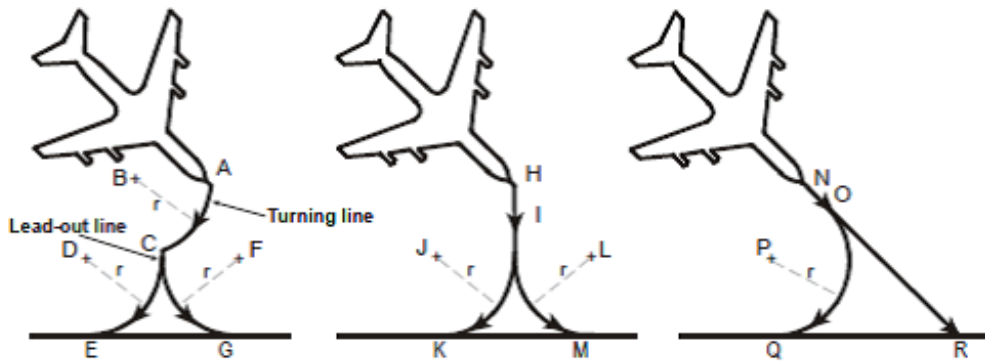
**Figure 8 - Simple nose wheel lead-in line**

Position	Description of point to be surveyed
A	Point of tangency of centre of lead-in marking with centre of taxilane marking
B	Centre of arc of lead-in line and radius
C	Point of tangency with centre of lead-in line marking
D	Centre of arc of lead-in line and radius
E	Point of tangency of centre of lead-in marking with centre of taxilane marking
F	Nose wheel position of parked aircraft
G	End of lead-in line marking

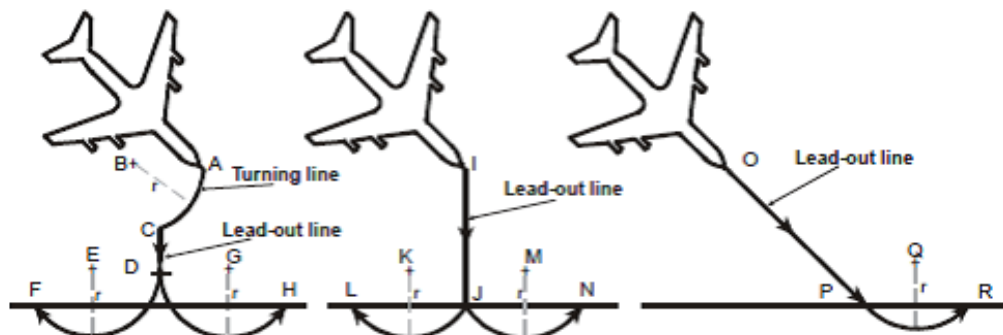
**Table 1**

**Figure 9 - Offset nose wheel lead-in line**

Position	Description of point to be surveyed
H	Intersection of centre of lead-in line marking and centre of taxilane marking
I	Centre of arc of lead-in line and radius
J	Centre of commencement of straight section of lead-in line
K	Intersection of centre of lead-in line marking and centre of taxilane marking
L	Centre of arc of lead-in line and radius
M	Nosewheel position of parked aircraft
N	End of lead-in line marking

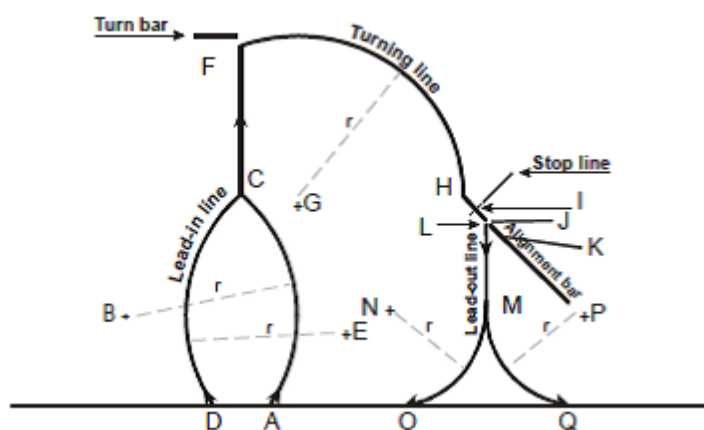
**Table 2**


**Figure 10 - Simple nose wheel lead-out lines**

Position	Description of point to be surveyed
A	Centre of commencement of turning line marking
B	Centre of arc of turning line and radius
C	Centre of intersection of turning line marking and lead-out line marking
D	Centre of arc of lead-out line and radius
E	Point of tangency of centre of lead-out line marking and taxilane marking
F	Centre of arc of lead-out line and radius
G	Point of tangency of centre of lead-out line marking and taxilane marking
H	Commencement of lead-out line
I	Centre of commencement of curved section of lead-out line
J	Centre of arc of lead-out line and radius
K	Point of tangency of centre of lead-out line marking and taxilane marking
L	Centre of arc of lead-out line and radius
M	Point of tangency of centre of lead-out line marking and taxilane marking
N	Point of tangency of centre of lead-out line marking and taxilane marking
O	Centre of commencement of curved section of lead-out line
P	Centre of arc of lead-out line and radius
Q	Point of tangency of centre of lead-out line marking and taxilane marking
R	Intersection of centre of lead-out line marking and taxilane marking

**Table 3**

**Figure 11 - Offset nose wheel lead-out lines**

Position	Description of point to be surveyed
A	Centre of commencement of turning line marking
B	Centre of arc of turning line and radius
C	Centre of intersection of turning line marking and lead-out line marking
D	Centre of end of straight section of lead-out line marking
E	Centre of arc of lead-out line and radius
F	Intersection of centre of lead-out line marking and taxilane marking
G	Centre of arc of lead-out line and radius
H	Intersection of centre of lead-out line marking and taxilane marking
I	Commencement of lead-out line
J	Centre of commencement of curved section of lead-out line
K	Centre of arc of lead-out line and radius
L	Intersection of centre of lead-out line marking and taxilane marking
M	Centre of arc of lead-out line and radius
N	Intersection of centre of lead-out line marking and taxilane marking
O	Commencement of lead-out line
P	Centre of commencement of curved section of lead-out line
Q	Centre of arc of lead-out line and radius
R	Intersection of centre of lead-out line marking and taxilane marking

**Table 4**

**Figure 12 - Turning lines**

Position	Description of point to be surveyed
A	Intersection of centre of lead-in line marking and centre of taxilane marking
B	Centre of arc of lead-in line and radius
C	Centre of commencement of straight section of lead-in line
D	Intersection of centre of lead-in line marking and centre of taxilane marking
E	Centre of arc of lead-in line and radius
F	End of straight section of lead-in line marking/commencement of turning line marking
G	Centre of arc of turning line and radius
H	Centre of commencement of straight section of turning line marking
I	Nose wheel position of parked aircraft
J	Centre of end of straight section or turning line marking
K	True bearing of alignment bar
L	Commencement of lead-out line
M	Centre of commencement of curved section of lead-out line
N	Centre of arc of lead-out line and radius
O	Point of tangency of centre of lead-out line marking and taxilane marking
P	Centre of arc of lead-out line and radius
Q	Point of tangency of centre of lead-out line marking and taxilane marking

**Table 5**

## GM3 ADR.OPS.A.005(a) Aerodrome data

*ED Decision 2014/012/R*

### FRICITION MEASURING DEVICES

A continuous friction measuring device (e.g. Skiddometer, Surface Friction Tester, Mu-meter, Runway Friction Tester or GripTester), can be used for measuring the friction values for compacted snow- and ice-covered runways. A decelerometer (e.g. Tapley Meter or Brakemeter — Dynamometer) may be used on certain surface conditions, e.g. compacted snow, ice and very thin layers of dry snow. Other friction measuring devices can be used, provided they have been correlated with, at least, one of the types mentioned above. A decelerometer should not be used in loose snow or slush, as it can give misleading friction values. Other friction measuring devices can also give misleading friction values under certain combinations of contaminants and air/pavement temperature.

## GM4 ADR.OPS.A.005(a) Aerodrome data

*ED Decision 2014/012/R*

### COVERAGE AREAS FOR TERRAIN AND OBSTACLE DATA PROVISION

- (a) The coverage areas for sets of electronic and obstacle data should be specified as follows:
- (1) Area 1: the entire territory of the State;
  - (2) Area 2: within the aerodrome surroundings, sub-divided as follows:
    - (i) Area 2a: a rectangular area around a runway that comprises the runway strip plus any clearway that exists;
    - (ii) Area 2b: an area extending from the ends of Area 2a in the direction of departure, with a length of 10 km and a splay of 15 per cent to each side;
    - (iii) Area 2c: an area extending outside Area 2a and Area 2b at a distance of not more than 10 km from the boundary of Area 2a; and

- (iv) Area 2d: an area outside the Areas 2a, 2b and 2c up to a distance of 45 km from the aerodrome reference point, or to an existing TMA boundary, whichever is nearest.
- (3) Area 3: the area bordering an aerodrome movement area that extends horizontally from the edge of a runway to 90 m from the runway centre line, and 50 m from the edge of all other parts of the aerodrome movement area
- (4) The area extending 900 m prior to the runway threshold, and 60 m each side of the extended runway centre line in the direction of the approach on a precision approach runway, Category II or III;
- (b) A graphical representation of the terrain data collection surfaces for Areas 1 and 2 is shown in the following figure:

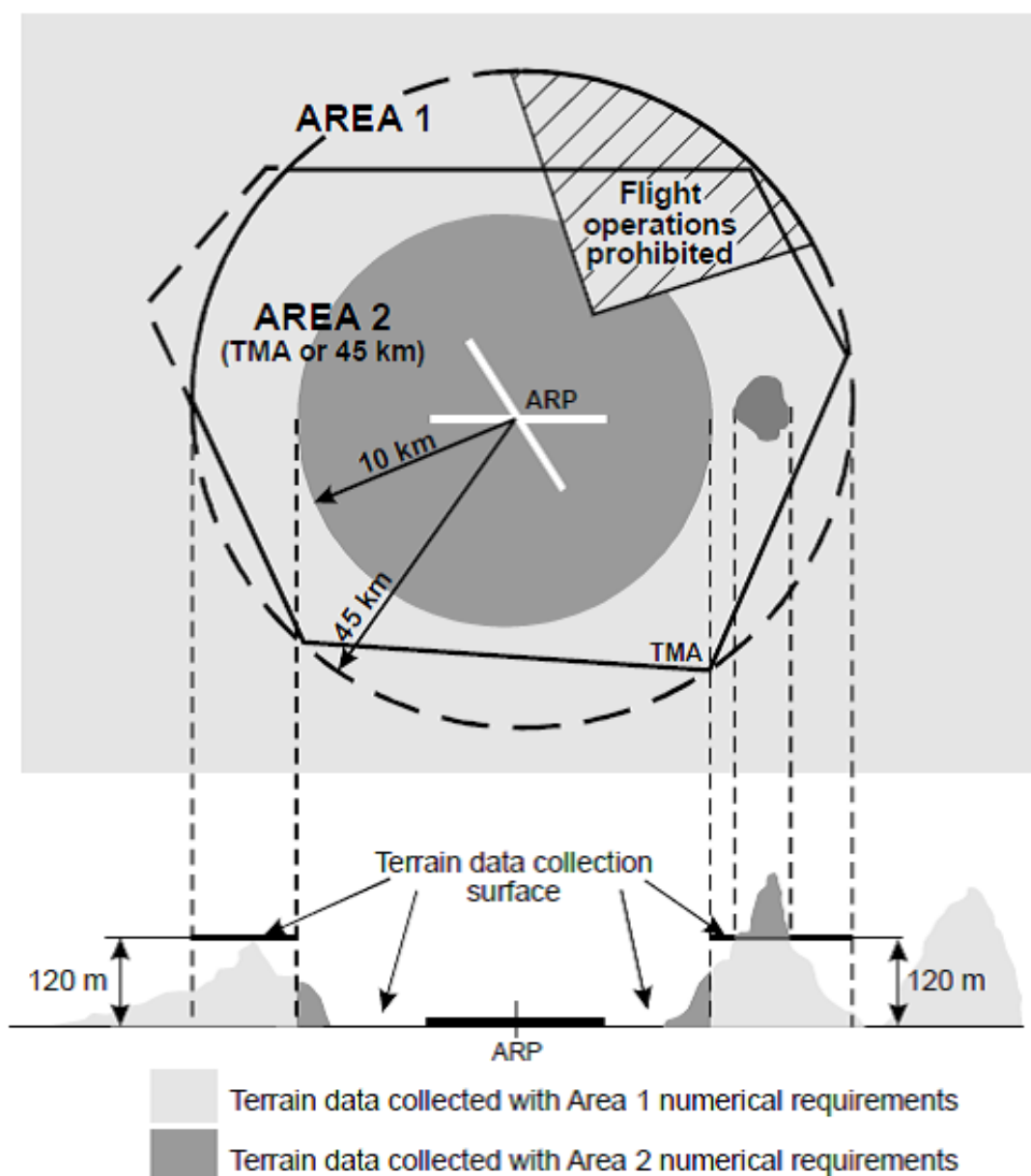
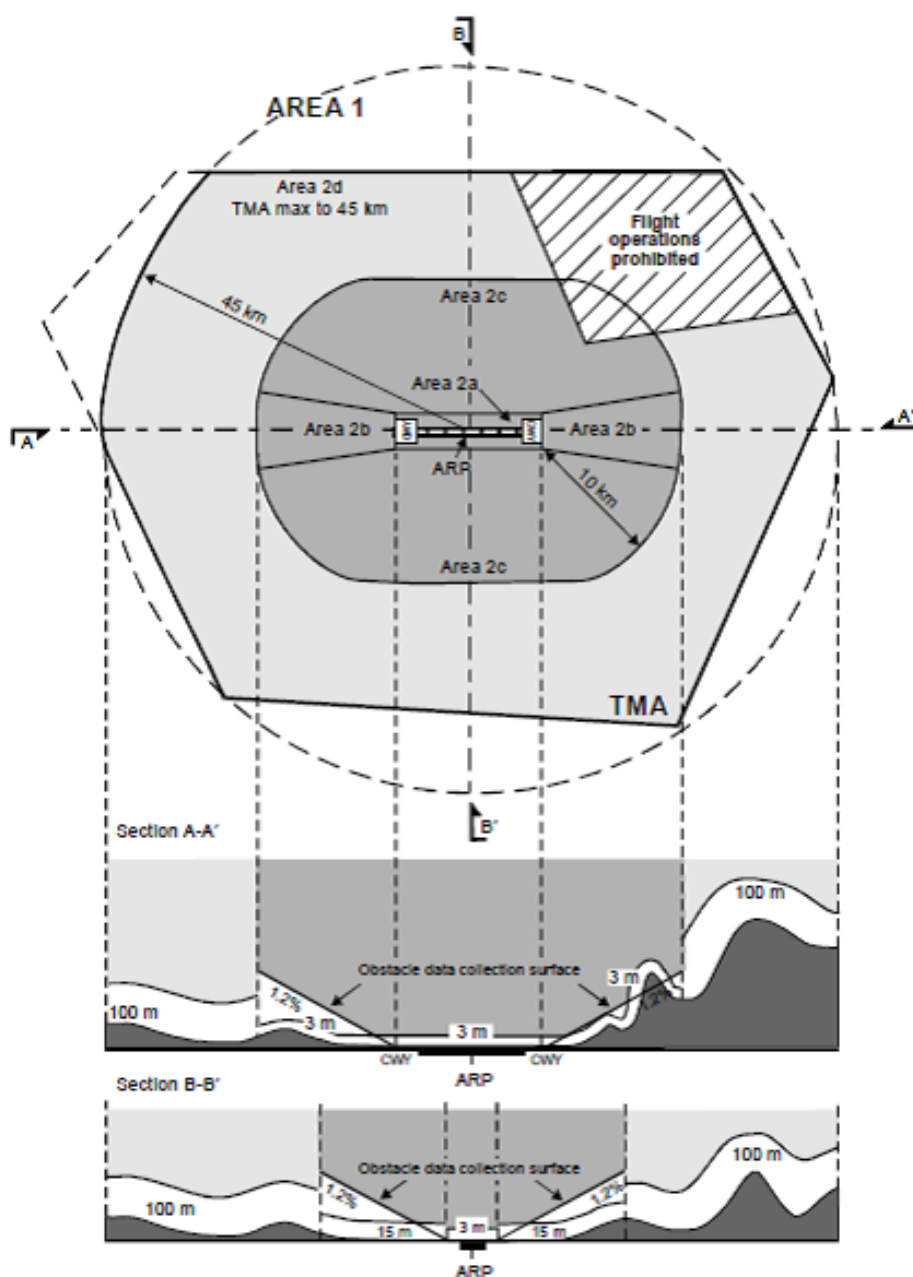


Figure 1 - Terrain data collection surfaces — Area 1 and Area 2



- (1) Within the area covered by a 10-km radius from the ARP, terrain data should comply with the Area 2 numerical requirements;
  - (2) In the area between 10 km and the TMA boundary or 45-km radius (whichever is smaller), data on terrain that penetrates the horizontal plane 120 m above the lowest runway elevation, should comply with the Area 2 numerical requirements;
  - (3) In the area between 10 km and the TMA boundary or 45-km radius (whichever is smaller), data on terrain that does not penetrate the horizontal plane 120 m above the lowest runway elevation, should comply with the Area 1 numerical requirements;
  - (4) In those portions of Area 2 where flight operations are prohibited due to very high terrain or other local restrictions and/or regulations, terrain data should comply with the Area 1 numerical requirements.
- (c) A graphical representation of the obstacle data collection surfaces for Areas 1 and 2 is shown in the following figure:



**Figure 2 - Obstacle data collection surfaces — Area 1 and Area 2**

- (1) Obstacle data should be collected and recorded in accordance with the Area 2 numerical requirements;
  - (i) The Area 2a obstacle collection surface should have a height of 3 m above the nearest runway elevation measured along the runway centre line, and for those portions related to a clearway, if one exists, at the elevation of the nearest runway end;
  - (ii) The Area 2b obstacle collection surface has an 1.2 % slope extending from the ends of Area 2a at the elevation of the runway end in the direction of departure, with a length of 10 km and a splay of 15 % to each side;

- (iii) The Area 2c collection surface has an 1.2 % slope extending outside Area 2a and Area 2b at a distance of not more than 10 km from the boundary of Area 2a. The initial elevation of Area 2c should be the elevation of the point of Area 2a at which it commences; and
  - (iv) The Area 2d obstacle collection surface has a height of 100 m above ground.
- (2) In those portions of Area 2 where flight operations are prohibited due to very high terrain or other local restrictions and/or regulations, obstacle data should be collected and recorded in accordance with the Area 1 requirements;
  - (3) Data on every obstacle within Area 1 whose height above the ground is 100 m or higher should be collected and recorded in the database in accordance with the Area 1 numerical requirements specified in Table 2.
- (d) A graphical representation of the terrain and obstacle data collection surfaces for Area 3 is shown in the following figure:

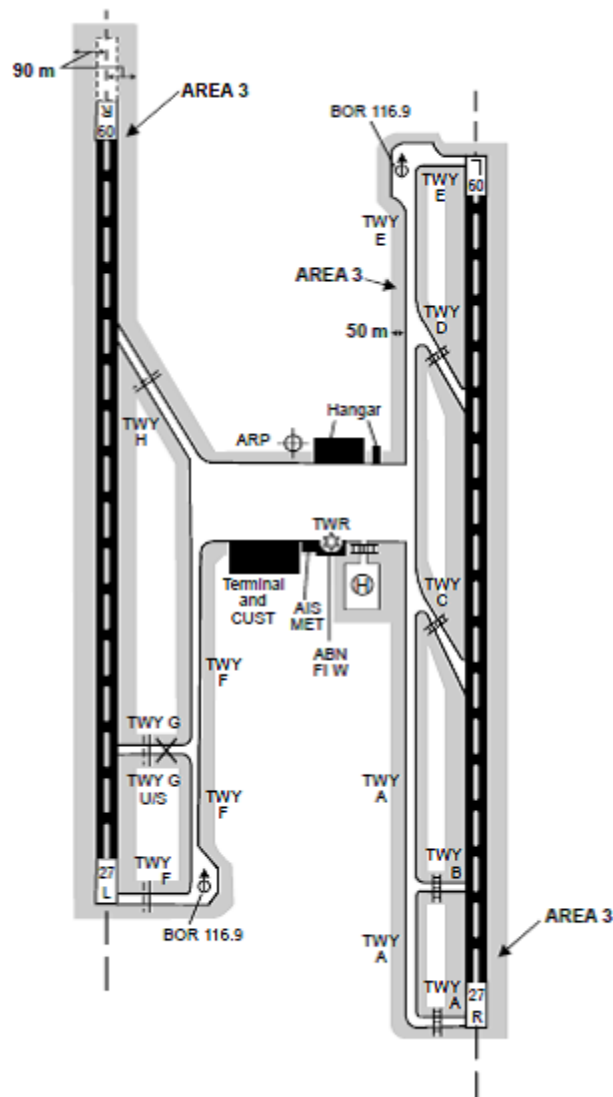
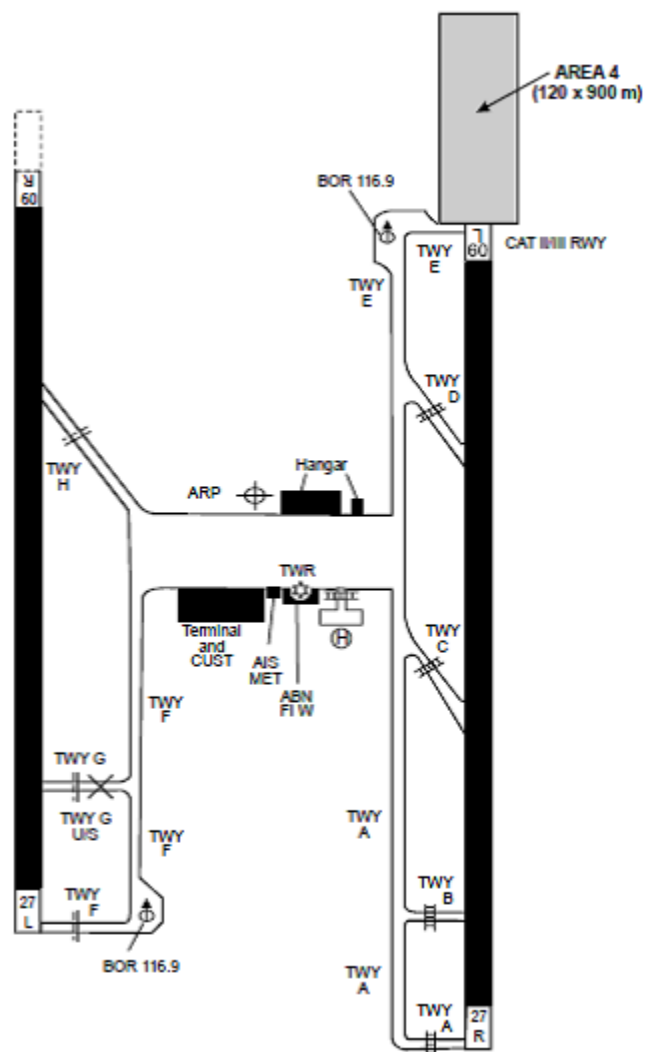


Figure 3 - Terrain and obstacle data collection surface — Area 3

- (1) The data collection surface for terrain and obstacles extends a half metre (0.5 m) above the horizontal plane passing through the nearest point on the aerodrome movement area;
  - (2) Terrain and obstacle data in Area 3 should comply with the numerical requirements specified in Tables 1 and 2, respectively;
- (e) A graphical representation of the obstacle data collection surfaces for Areas 4 is shown in the following figure:



**Figure 4 - Terrain and obstacle data collection surface — Area 4**

- (1) Terrain data in Area 4 should comply with the numerical requirements specified in Table 1;
- (2) The horizontal extent of Area 2 covers Area 4. More detailed obstacle data may be collected in Area 4 in accordance with Area 4 numerical requirements for obstacle data specified in Table 2.
- (3) Where the terrain at a distance greater than 900 m (3000 ft) from the runway threshold is mountainous or otherwise significant, the length of Area 4 should be extended to a distance not exceeding 2000 m (6500 ft) from the runway threshold.

	Area 1	Area 2	Area 3	Area 4
Post spacing	3 arc seconds (approx. 90 m)	1 arc seconds (approx. 30 m)	0.6 arc seconds (approx. 20 m)	0.3 arc seconds (approx. 9 m)
Vertical accuracy	30 m	3 m	0.5 m	1 m
Vertical resolution	1 m	0.1 m	0.01 m	0.1 m
Horizontal accuracy	50 m	5 m	0.5 m	2.5 m
Confidence level	90 %	90 %	90 %	90 %
Data classification Integrity level	Routine	Essential	Essential	Essential
Maintenance period	as required	as required	as required	as required

**Table 1 - Terrain data numerical requirements**

	Area 1	Area 2	Area 3	Area 4
Vertical accuracy	30 m	3 m	0.5 m	1 m
Vertical resolution	1 m	0.1 m	0.01 m	0.1 m
Horizontal accuracy	50 m	5 m	0.5 m	2.5 m
Confidence level	90 %	90 %	90 %	90 %
Data classification Integrity level	Routine	Essential	Essential	Essential
Maintenance period	as required	as required	as required	as required

**Table 2 - Obstacle data numerical requirements**

## ADR.OPS.A.010 Data quality requirements

*Regulation (EU) No 139/2014 139/2014*

The aerodrome operator shall have formal arrangements with organisations with which it exchanges aeronautical data and/or aeronautical information.

- (a) All data relevant to the aerodrome and available services shall be provided by the aerodrome operator with the required quality and integrity.
- (b) When data relevant to the aerodrome and available services are published, the aerodrome operator, shall:
  - (1) monitor data relevant to the aerodrome and available services originating from the aerodrome operator and promulgated by the relevant air traffic services providers and aeronautical information services providers;
  - (2) notify the relevant aeronautical information services providers of any changes necessary to ensure correct and complete data relevant to the aerodrome and available services, originating from the aerodrome operator;
  - (3) notify the relevant air traffic services providers and aeronautical information services providers when the published data originating from the aerodrome operator are incorrect or inappropriate.

*[applicable until 26 January 2022]*

## ADR.OPS.A.010 Data quality requirements

Delegated Regulation (EU) 2020/2148

The aerodrome operator shall have formal arrangements with the organisations with which it exchanges aeronautical data or aeronautical information and shall ensure the following:

- (a) all data relevant to the aerodrome and available services is provided with the required quality; data quality requirements (DQRs) are complied with at data origination and maintained during data transmission;
- (b) the accuracy of aeronautical data is as specified in the aeronautical data catalogue;
- (c) the integrity of aeronautical data is maintained throughout the data process from origination to transmission, based on the integrity classification specified in the aeronautical data catalogue. In addition, procedures shall be put in place so that:
  - (1) for routine data, corruption is avoided throughout the processing of the data;
  - (2) for essential data, corruption does not occur at any stage of the entire process and additional processes are included, as needed, to address potential risks in the overall system architecture to ensure data integrity at that level;
  - (3) for critical data, corruption does not occur at any stage of the entire process and additional integrity assurance processes are included to fully mitigate the effects of faults identified by thorough analysis of the overall system architecture as potential data integrity risks;
- (d) the resolution of the aeronautical data is commensurate with the actual data accuracy;
- (e) the traceability of the aeronautical data;
- (f) the timeliness of the aeronautical data, including any limits on the effective period;
- (g) the completeness of the aeronautical data;
- (h) the format of the delivered data meets the specified requirements.

*[applicable from 27 January 2022]*

## AMC1 ADR.OPS.A.010 Data quality requirements

ED Decision 2014/012/R

### GENERAL REQUIREMENTS

- (a) The integrity of aeronautical data should be maintained throughout the data process from survey/origin to the next intended user. Based on the applicable integrity classification, the validation and verification procedures should:
  - (1) for routine data: avoid corruption throughout the processing of the data;
  - (2) for essential data: assure corruption does not occur at any stage of the entire process and may include additional processes as needed to address potential risks in the overall system architecture to further assure data integrity at this level; and
  - (3) for critical data: assure corruption does not occur at any stage of the entire process and include additional integrity assurance procedures to fully mitigate the effect of faults identified by thorough analysis of the overall system architecture as potential data integrity risks.

- (b) The aerodrome operator should determine and report aerodrome-related aeronautical data in accordance with the accuracy and integrity requirements set in the following tables:

Latitude and longitude	Accuracy Data Type	Integrity Classification
Aerodrome reference point	30 m surveyed/calculated	routine
Nav aids located at the aerodrome	3 m surveyed	essential
Obstacles in Area 3	0.5 m surveyed	essential
Obstacles in Area 2 (the part within the aerodrome boundary)	5 m surveyed	essential
Runway thresholds	0.3 m surveyed	critical
Runway end (flight path alignment point)	1 m surveyed	critical
Runway centre line points	1 m surveyed	critical
Runway-holding position	0.5 m surveyed	critical
Taxiway centre line/parking guidance line points	0.5 m surveyed	essential
Taxiway intersection marking line	0.5 m surveyed	essential
Exit guidance line	0.5 m surveyed	essential
Apron boundaries (polygon)	1 m surveyed	routine
De-icing/anti-icing facility (polygon)	1 m surveyed	routine
Aircraft stand points/INS checkpoints	0.5 m surveyed	routine

**Table 1 – Latitude and longitude**

Elevation/altitude/height	Accuracy Data type	Integrity Classification
Aerodrome elevation	0.5 m surveyed	essential
WGS-84 geoid undulation at aerodrome elevation position	0.5 m surveyed	essential
Runway threshold, non-precision approaches	0.5 m surveyed	essential
WGS-84 geoid undulation at runway threshold, non-precision approaches	0.5 m surveyed	essential
Runway threshold, precision approaches	0.25 m surveyed	critical
WGS-84 geoid undulation at runway threshold, precision approaches	0.25 m surveyed	critical
Runway centre line points	0.25 m surveyed	critical
Taxiway centre line/parking guidance line points	1 m surveyed	essential
Obstacles in Area 2 (the part within the aerodrome boundary)	3 m surveyed	essential
Obstacles in Area 3	0.5 m surveyed	essential
Distance measuring equipment/precision (DME/P)	3 m surveyed	essential

**Table 2 – Elevation/Altitude/Height**

Declination/variation	Accuracy Data type	Integrity Classification
VHF Navaid Station Declination	1 degree surveyed	essential

<b>Aerodrome magnetic variation</b>	1 degree surveyed	essential
<b>ILS localizer antenna magnetic variation</b>	1 degree surveyed	essential
<b>MLS azimuth antenna magnetic variation</b>	1 degree surveyed	essential

**Table 3 – Declination and magnetic variation**

<b>Bearing</b>	<b>Accuracy Data type</b>	<b>Integrity Classification</b>
<b>ILS localizer alignment</b>	1/100 degree surveyed	essential
<b>MLS zero azimuth alignment</b>	1/100 degree surveyed	essential
<b>Runway bearing (True)</b>	1/100 degree surveyed	routine

**Table 4 – Bearing**

<b>Length/distance/dimension</b>	<b>Accuracy Data type</b>	<b>Integrity Classification</b>
<b>Runway length</b>	1 m surveyed	critical
<b>Runway width</b>	1 m surveyed	essential
<b>Displaced threshold distance</b>	1 m surveyed	routine
<b>Stopway length and width</b>	1 m surveyed	critical
<b>Clearway length and width</b>	1 m surveyed	essential
<b>Landing distance available</b>	1 m surveyed	critical
<b>Take-off run available</b>	1 m surveyed	critical
<b>Take-off distance available</b>	1 m surveyed	critical
<b>Accelerate-stop distance available</b>	1 m surveyed	critical
<b>Runway shoulder width</b>	1 m surveyed	essential
<b>Taxiway width</b>	1 m surveyed	essential
<b>Taxiway shoulder width</b>	1 m surveyed	essential
<b>ILS localizer antenna-runway end, distance</b>	3 m calculated	routine
<b>ILS glide slope antenna-threshold, distance along centre line</b>	3 m calculated	routine
<b>ILS marker-threshold distance</b>	3 m calculated	essential
<b>ILS DME antenna-threshold, distance along centre line</b>	3 m calculated	essential
<b>MLS azimuth antenna-runway end, distance</b>	3 m calculated	routine
<b>MLS elevation antenna-threshold, distance along centre line</b>	3 m calculated	routine
<b>MLS DME/P antenna-threshold, distance along centre line</b>	3 m calculated	essential

**Table 5 – Length/distance/dimension**

- (c) Accuracy requirements for aeronautical data should be based upon a 95 % confidence level and, in that respect, three types of positional data should be identified: surveyed points (e.g. runway threshold), calculated points (mathematical calculations from the known surveyed points of points in space, fixes) and declared points (e.g. flight information region boundary points).
- (d) Geographical coordinates indicating latitude and longitude should be determined and reported to the aeronautical information services in terms of the World Geodetic System — 1984 (WGS-



- 84) geodetic reference datum, identifying those geographical coordinates which have been transformed into WGS-84 coordinates by mathematical means, and whose accuracy of original field work does not meet the requirements in Table 3.
- (e) The order of accuracy of the field work should be such that the resulting operational navigation data for the phases of flight will be within the maximum deviations, with respect to an appropriate reference frame, as indicated in the Tables 3–7.
  - (f) In addition to the elevation (referenced to mean sea level) of the specific surveyed ground positions at aerodromes, geoid undulation (referenced to the WGS-84 ellipsoid) for those positions as indicated in Tables 3–7, should be determined and reported to the aeronautical information services authority.
  - (g) Protection of electronic aeronautical data while stored or in transit, should be totally monitored by the cyclic redundancy check (CRC). To achieve protection of the integrity level of critical, and essential aeronautical data as classified in (a)(1) and (a)(2) above, a 32- or 24-bit CRC algorithm should apply respectively.
  - (h) To achieve protection of the integrity level of routine aeronautical data as classified in (a)(3) above, a 16-bit CRC algorithm should apply.
  - (i) The aerodrome operator should implement the procedures to:
    - (1) monitor data relevant to the aerodrome and available services originating from the aerodrome operator, and promulgated by the relevant air traffic services providers;
    - (2) notify the relevant aeronautical information services, and air traffic services providers of any changes necessary to ensure correct and complete data relevant to the aerodrome, and available services.

*[applicable until 26 January 2022]*

#### GENERAL REQUIREMENTS

The aerodrome operator should implement the procedures to:

- (a) monitor data relevant to the aerodrome and available services originating from the aerodrome operator, and promulgated by the relevant air traffic services providers;
- (b) notify the relevant aeronautical information services, and air traffic services providers of any changes necessary to ensure correct and complete data relevant to the aerodrome, and available services.

*[applicable from 27 January 2022 — ED Decision 2021/003/R]*

## AMC2 ADR.OPS.A.010 Data quality requirements

*ED Decision 2014/012/R*

#### FORMAL ARRANGEMENTS

- (a) Organisations concerned

The aerodrome operator should have formal arrangements with public or private entities providing:

  - (1) air navigation services;
  - (2) services for the origination and provision of survey data;
  - (3) procedure design services;

- (4) electronic terrain data; and
  - (5) electronic obstacle data,
- with which it exchanges aeronautical data and/or aeronautical information.

(b) Content of formal arrangements

Such formal arrangements should include the following minimum content:

- (1) the scope of aeronautical data or aeronautical information to be provided;
- (2) the accuracy, resolution, and integrity requirements for each data item supplied;
- (3) the required methods for demonstrating that the data provided conforms with the specified requirements;
- (4) the nature of action to be taken in the event of discovery of a data error, or inconsistency in any data provided;
- (5) the following minimum criteria for notification of data changes:
  - (i) criteria for determining the timeliness of data provision based on the operational or safety significance of the change;
  - (ii) any prior notice of expected changes;
  - (iii) the means to be adopted for notification;
- (6) the party responsible for documenting data changes;
- (7) the means to resolve any potential ambiguities caused where different formats are used to exchange aeronautical data or aeronautical information;
- (8) any limitations on the use of data;
- (9) requirements for the production of quality reports by data providers to facilitate verification of data quality by the data users;
- (10) metadata requirements; and
- (11) contingency requirements concerning the continuity of data provision.

*[applicable until 26 January 2022]*

(b) Content of formal arrangements

Such formal arrangements should include the following minimum content:

- (1) aeronautical data to be provided;
- (2) the quality requirements for each data item supplied according to the aeronautical data catalogue;
- (3) the method(s) for demonstrating that the data provided conforms with the specified requirements;
- (4) the action to be taken in the event of discovery of a data error, or inconsistency in any data provided;
- (5) the following minimum criteria for notification of data changes:
  - (i) criteria for determining the timeliness of data provision based on the operational or safety significance of the change;

- (ii) any prior notice of expected changes; and
- (iii) the means to be adopted for notification;
- (6) the party responsible for documenting data changes;
- (7) data exchange details such as format or format change process;
- (8) any limitations on the use of data;
- (9) requirements for the production of data origination quality reports;
- (10) metadata to be provided; and
- (11) contingency requirements concerning the continuity of data provision.

*[applicable from 27 January 2022 — ED Decision 2021/003/R]*

## GM1 ADR.OPS.A.010 Data quality requirements

*ED Decision 2014/012/R*

Information in respect to the processing of aeronautical data and aeronautical information is contained in RTCA Document DO-200A and European Organization for Civil Aviation Equipment (EUROCAE) Document ED-76A – Standards for Processing Aeronautical Data.

*[applicable until 26 January 2022]*

### CONTRACTED ACTIVITIES

In case of contracted activities to external organisations for the origination of aeronautical data and aeronautical information, data origination requirements for such organisations are to be found in ATM/ANS.OR.085 of Annex III of [Commission Implementing Regulation \(EU\) 2017/373](#).

*[applicable from 27 January 2022 — ED Decision 2021/003/R]*

## GM2 ADR.OPS.A.010 Data quality requirements

*ED Decision 2021/003/R*

### URGENT DISTRIBUTION OF AERONAUTICAL INFORMATION

The obligation to comply with the relevant provisions of [ADR.OPS.A.010](#) (Data quality requirements) does not prevent the urgent distribution of aeronautical information necessary to ensure the safety of flight. It is recognised that, in this case, it is not always possible to comply with all the relevant provisions. However, it is also not possible to determine a priori in all cases where this exception may apply; hence this is dependent on a case-by-case individual assessment made by competent staff.

*[applicable from 27 January 2022]*

## GM1 ADR.OPS.A.010(d) Data quality requirements

*ED Decision 2021/003/R*

### RESOLUTION

- (a) Stating that resolution needs to be commensurate with the actual accuracy means that digital data needs to have sufficient resolution to maintain accuracy. Typically, if an accuracy of 0.1 unit is needed, then a resolution of 0.01 or 0.001 units would enable a data chain to preserve the accuracy without any issue. A finer resolution could be misleading as one could assume that it supports a finer accuracy. This factor range of 10 to 100 between accuracy and resolution is applicable regardless of the units of measurements used.

(b) The resolution should be enough to capture the accuracy of the data.

*[applicable from 27 January 2022]*

## GM1 ADR.OPS.A.010(e) Data quality requirements

*ED Decision 2021/003/R*

### TRACEABILITY

Traceability is supported by maintaining the metadata.

*[applicable from 27 January 2022]*

## ADR.OPS.A.015 Coordination between aerodrome operators and providers of aeronautical information services

*Regulation (EU) No 139/2014*

- (a) To ensure that aeronautical information services providers obtain information to enable them to provide up-to-date pre-flight information and to meet the need for in-flight information, the aerodrome operator shall make arrangements to report to the relevant aeronautical information service providers, with a minimum of delay, the following:
- (1) information on the aerodrome conditions, disabled aircraft removal, rescue and firefighting and visual approach slope indicator systems;
  - (2) the operational status of associated facilities, services and navigational aids at the aerodrome;
  - (3) any other information considered to be of operational significance.
- (b) Before introducing changes to the air navigation system, the aerodrome operator shall take due account of the time needed by the relevant aeronautical information services for the preparation, production and issue of relevant material for promulgation.

## AMC1 ADR.OPS.A.015 Coordination between aerodrome operators and providers of aeronautical information services

*ED Decision 2014/012/R*

### REPORTING

- (a) The aerodrome operator should report on matters of operational significance or affecting aircraft and aerodrome operations in order to take appropriate action, particularly in respect of the following:
- (1) construction or maintenance work;
  - (2) rough or broken surfaces on a runway, a taxiway, or an apron;
  - (3) snow, slush ice or frost on a runway, a taxiway, or an apron;
  - (4) water on a runway, a taxiway, or an apron;
  - (5) snow banks or drifts adjacent to a runway, a taxiway, or an apron;
  - (6) anti-icing or de-icing liquid chemicals, or other contaminants on a runway, a taxiway, or an apron;
  - (7) other temporary hazards, including parked aircraft;

- (8) failure or irregular operation of part or all of the aerodrome visual aids; and
  - (9) failure of the normal or secondary power supply.
- (b) A change in the level of protection normally available at an aerodrome for rescue and firefighting should be expressed in terms of the new category available at the aerodrome. When such a change has been corrected, the air traffic services provider and the aeronautical information services providers should be advised accordingly.
- (c) The aerodrome operator should observe the predetermined, internationally agreed AIRAC effective dates in addition to 14-day postage time when submitting the raw information/data to aeronautical information services that affect charts and/or computer-based navigation systems which qualify to be notified by the aeronautical information regulation and control (AIRAC) system.

## ADR.OPS.A.020 Common reference systems

*Delegated Regulation (EU) 2020/2148*

For the purpose of air navigation, the aerodrome operator shall use:

- (a) the World Geodetic System – 1984 (WGS-84) as the horizontal reference system;
- (b) the mean sea level (MSL) datum as the vertical reference system;
- (c) the Gregorian calendar and coordinated universal time (UTC) as the temporal reference systems.

*[applicable from 27 January 2022]*

## GM1 ADR.OPS.A.020(a) Common reference systems

*ED Decision 2021/003/R*

### HORIZONTAL REFERENCE SYSTEM — WGS-84

- (a) A reference system provides a definition of a coordinate system in terms of the position of an origin in space, the orientation of an orthogonal set of Cartesian axes, and a scale. A terrestrial reference system defines a spatial reference system in which positions of points anchored on the Earth's solid surface have coordinates. Examples are: WGS-84, ITRS/European Terrestrial Reference System (ETRS) and national reference systems.
- (b) WGS-84 defines, inter alia, a conventional terrestrial reference system, a reference frame and a reference ellipsoid. WGS-84 is currently the reference system ICAO requires for georeferencing aeronautical information.
- (c) Further explanation and guidance may be found in Annex B (Horizontal reference systems) to EUROCONTROL Specifications for the Origination of Aeronautical Data, Volume 2: Guidance material (EUROCONTROL-SPEC-154, Edition 1.0 of 04/02/2013).

*[applicable from 27 January 2022]*

## GM2 ADR.OPS.A.020(a) Common reference systems

*ED Decision 2021/003/R*

### TEMPORARY NON-COMPLIANCE OF GEOGRAPHICAL CO-ORDINATES

In those particular cases where geographical co-ordinates have been transformed into WGS-84 coordinates by mathematical means and whose accuracy of original field work does not meet the

applicable requirements contained in the aeronautical data catalogue, they should be identified until the time when they can be compliant.

*[applicable from 27 January 2022]*

## AMC1 ADR.OPS.A.020(b) Common reference systems

*ED Decision 2021/003/R*

### VERTICAL REFERENCE SYSTEM

- (a) The aerodrome operator should use the Earth Gravitational Model — 1996 (EGM-96), as the global gravity model.
- (b) When a geoid model other than the EGM-96 model is used, a description of the model used, including the parameters required for height transformation between the model and EGM-96, should be provided in the aeronautical information publication (AIP).

*[applicable from 27 January 2022]*

## GM1 ADR.OPS.A.020(b) Common reference systems

*ED Decision 2021/003/R*

### VERTICAL REFERENCE SYSTEM

Further explanation and guidance may be found in Annex C (Vertical reference systems) to EUROCONTROL Specifications for the Origination of Aeronautical Data, Volume 2 (EUROCONTROL-SPEC-154, Edition 1.0 of 04/02/2013).

*[applicable from 27 January 2022]*

## GM2 ADR.OPS.A.020(b) Common reference systems

*ED Decision 2021/003/R*

### MEAN SEA LEVEL

- (a) The geoid globally most closely approximates mean sea level (MSL). It is defined as the equipotential surface in the gravity field of the Earth, which coincides with the undisturbed MSL extended continuously through the continents.
- (b) Gravity-related heights (elevations) are also referred to as ‘orthometric heights’, while distances of points above the ellipsoid are referred to as ‘ellipsoidal heights’.
- (c) Global and local geoids differ in their origin: global geoids consider only the long- and middle-wave part of the Earth’s gravity field, whilst local geoids also consider the short-wave part of the gravity field. Global geoids are used when consistent orthometric heights, over long distances (continent or earth surveying), are required. Currently, the world’s best global geoid model is EGM 200846. It was determined using satellite tracking, gravity anomalies and satellite altimetry. Its accuracy is in the range of  $\pm 0.05$  m (oceans) and  $\pm 0.5$  m (on land). This accuracy is higher in flat regions than in topographically mountainous terrain, such as the Alps.
- (d) For local engineering applications and cadastre-surveying, global geoids are not as accurate as needed. For such applications, local geoid models are calculated. These can only be developed using local field measurements. They offer centimetre accuracy over several hundred kilometres, with a high resolution. Local geoids are not suitable for height comparison over large distances since they are based on different origins and reference heights (different equipotential levels).

[applicable from 27 January 2022]

## GM1 ADR.OPS.A.020(c) Common reference system

ED Decision 2021/003/R

### TEMPORAL REFERENCE SYSTEM

- (a) A value in the time domain is a temporal position measured relative to a temporal reference system.
- (b) ISO Standard 8601 specifies the use of the Gregorian calendar and 24-hour local or UTC for information interchange, while ISO Standard 19108 prescribes the Gregorian calendar and UTC as the primary temporal reference system for use with geographic information.

[applicable from 27 January 2022]

## ADR.OPS.A.025 Data error detection and authentication

Delegated Regulation (EU) 2020/2148

When originating, processing or transmitting data to the aeronautical information service (AIS) provider, the aerodrome operator shall:

- (a) ensure that digital data error detection techniques are used during the transmission and storage of aeronautical data, in order to support the applicable data integrity levels;
- (b) ensure that the transfer of aeronautical data is subject to a suitable authentication process such that recipients are able to confirm that the data or information has been transmitted by an authorised source.

[applicable from 27 January 2022]

## GM1 ADR.OPS.A.025 Data error detection and authentication

ED Decision 2021/003/R

### DIGITAL DATA ERROR DETECTION TECHNIQUES

- (a) Digital data error detection techniques can be used to detect errors during the transmission or storage of data. An example of a digital error detection technique is the use of cyclic redundancy checks (CRCs). Coding techniques can be effective regardless of the transmission media (e.g. computer disks, modem communication, or internet).
- (b) Transmission of data via electronic/digital means (e.g. file transfer protocol (FTP) sites, web downloads, or email) may be subject to malicious attack that can corrupt the integrity of data for its intended use. Provision of means to mitigate the intentional corruption of digitally transmitted data may already exist within the organisational construct and operating procedures of participating entities.
- (c) The objective of data security is to ensure that data is received from a known source and that there is no intentional corruption during processing and exchange of data.
- (d) Records are maintained to show what data security provisions have been implemented.
- (e) Provisions supporting this objective may include:
  - (1) implementation of technical data security measures to provide authentication and prevent intentional corruption during exchange of data (e.g. secure hashes, secure transmissions, digital signatures); and

- (2) implementation of organisational data security measures to protect processing resources and prevent intentional corruption during processing of data.

*[applicable from 27 January 2022]*

## GM2 ADR.OPS.A.025 Data error detection and authentication

*ED Decision 2021/003/R*

### DATA ERROR PROCESSING

More explanation and guidance may be found in Appendix C (Guidance on compliance with data processing requirements) to EUROCAE ED-76A.

*[applicable from 27 January 2022]*

## ADR.OPS.A.030 Aeronautical data catalogue

*Delegated Regulation (EU) 2020/2148*

When originating, processing or transmitting data to the AIS provider, the aerodrome operator shall ensure that the aeronautical data referred to in Appendix 1 to Annex III (Part-ATM/ANS.OR) to Commission Implementing Regulation (EU) 2017/373<sup>1</sup> conform to the data catalogue specifications.

*[applicable from 27 January 2022]*

## GM1 ADR.OPS.A.030 Aeronautical Data Catalogue

*ED Decision 2021/003/R*

### GENERAL

The aeronautical data catalogue presents the scope of data that can be collected and maintained by the aeronautical information services providers and provides a common terminology that can be used by data originators and service providers.

*[applicable from 27 January 2022]*

## ADR.OPS.A.035 Data validation and verification

*Delegated Regulation (EU) 2020/2148*

When originating, processing or transmitting data to the AIS provider, the aerodrome operator shall ensure that validation and verification techniques are employed so that the aeronautical data meets the associated DQRs. In addition:

- (a) the verification shall ensure that the aeronautical data is received without corruption and that the aeronautical data process does not introduce corruption;
- (b) aeronautical data and aeronautical information entered manually shall be subject to independent verification to detect any errors that may have been introduced;
- (c) when using aeronautical data to obtain or calculate new aeronautical data, the initial data shall be verified and validated, except when provided by an authoritative source.

*[applicable from 27 January 2022]*

<sup>1</sup> Commission Implementing Regulation (EU) 2017/373 of 1 March 2017 laying down common requirements for providers of air traffic management/air navigation services and other air traffic management network functions and their oversight, repealing Regulation (EC) No 482/2008, Implementing Regulations (EU) No 1034/2011, (EU) No 1035/2011 and (EU) 2016/1377 and amending Regulation (EU) No 677/2011 (OJ L 62, 8.3.2017, p. 1).



## AMC1 ADR.OPS.A.035 Data verification and validation

ED Decision 2021/003/R

### VALIDATION AND VERIFICATION

- (a) The processes implemented to carry out validation and verifications should define the means used to:
  - (1) verify received data and confirm that the data has been received without corruption;
  - (2) preserve data quality and ensure that stored data is protected from corruption; and
  - (3) confirm that originated data has not been corrupted prior to being stored.
- (b) Those processes should define the:
  - (1) actions to be taken when data fails a verification or validation check; and
  - (2) tools required for the verification and validation process.

[applicable from 27 January 2022]

## GM1 ADR.OPS.A.035 Data verification and validation

ED Decision 2021/003/R

### VALIDATION AND VERIFICATION — GENERAL

- (a) Validation
  - (1) Validation is the activity where a data element is checked as having a value that is fully applicable to the identity ascribed to the data element, or where a set of data elements are checked as being acceptable for their intended use.
  - (2) The application of validation techniques considers the entire aeronautical data chain. This includes the validation performed by prior data chain participants and any requirements levied on the data supplier.
  - (3) Examples of validation techniques include:
    - (i) Validation by application

One method of validation is to apply data under test conditions. In certain cases, this may not be practical. Validation by application is considered to be the most effective form of validation. For example, flight inspection of final approach segment data prior to publication can be used to ensure that the published data is acceptable.
    - (ii) Logical consistency

Logical consistency validates by comparing two different data sets or elements and identifying inconsistencies between values based on operative rules (e.g. business rules).
    - (iii) Semantic consistency

Semantic consistency validates by comparing data to an expected value or range of values for the data characteristics.
    - (iv) Validation by sampling

Validation by sampling evaluates a representative sample of data and applies statistical analysis to determine the confidence in the data quality.

**(b) Verification**

- (1) Verification is a process for checking the integrity of a data element whereby the data element is compared to another source, either from a different process or from a different point in the same process. While verification cannot ensure that the data is correct, it can be effective to ensure that the data has not been corrupted by the data process.
- (2) The application of verification techniques considers only the portion of the aeronautical data chain controlled by the organisation. Yet, verification techniques may be applied at multiple phases of the data processing chain.
- (3) Examples of verification techniques include:
  - (i) **Feedback**

Feedback testing is the comparison between the output and input state of a data set.
  - (ii) **Independent redundancy**

Independent redundancy testing involves processing the same data through two or more independent processes and comparing the data output of each process.
  - (iii) **Update comparison**

Updated data can be compared to its previous version. This comparison can identify all data elements that have changed. The list of changed elements can then be compared to a similar list generated by the supplier. A problem can be detected if an element is identified as changed on one list and not on the other.

*[applicable from 27 January 2022]*

## GM2 ADR.OPS.A.035 Data verification and validation

*ED Decision 2021/003/R*

### VALIDATION AND VERIFICATION TECHNIQUES

Validation and verification techniques are employed throughout the data processing chain to ensure that the data meets the associated data quality requirements. More explanatory material may be found in Appendix C (Guidance on compliance with data processing requirements) to EUROCAE ED-76A 'Standards for Processing Aeronautical Data'.

*[applicable from 27 January 2022]*

## ADR.OPS.A.040 Error handling requirements

*Delegated Regulation (EU) 2020/2148*

The aerodrome operator shall ensure that:

- (a) errors identified during data origination and after data delivery are addressed, corrected or resolved;
- (b) priority is given to managing errors in critical and essential aeronautical data.

*[applicable from 27 January 2022]*

## GM1 ADR.OPS.A.040 Error handling requirements

ED Decision 2021/003/R

### GENERAL

- (a) The term ‘error’ is understood as being defective, degraded, lost, misplaced or corrupted data elements, or data elements not meeting stated quality requirements.
- (b) Guidance on how to detect, identify, report and address/resolve aeronautical data errors may be found in Appendix C (Guidance on compliance with data processing requirements) to EUROCAE ED-76A ‘Standards for Processing Aeronautical Data’.

[applicable from 27 January 2022]

## ADR.OPS.A.045 Metadata

Delegated Regulation (EU) 2020/2148

The aerodrome operator shall ensure that metadata include, as a minimum:

- (a) the identification of the organisations or entities performing any action of originating, transmitting or manipulating the aeronautical data;
- (b) the action performed;
- (c) the date and time the action was performed.

[applicable from 27 January 2022]

## ADR.OPS.A.050 Data transmission

Delegated Regulation (EU) 2020/2148

The aerodrome operator shall ensure that aeronautical data is transmitted by electronic means.

[applicable from 27 January 2022]

## ADR.OPS.A.055 Tools and software

Delegated Regulation (EU) 2020/2148

When originating, processing or transmitting aeronautical data to the AIS provider, the aerodrome operator shall ensure that tools and software used to support or automate aeronautical data processes perform their functions without adversely impacting the quality of the aeronautical data.

[applicable from 27 January 2022]

## GM1 ADR.OPS.A.055 Tools and software

ED Decision 2021/003/R

### SOFTWARE

- (a) A means by which the requirement can be met, is through the verification of software applied to a known executable version of the software in its target operating environment.
- (b) The verification of software is a process of ensuring that the software meets the requirements for the specified application or intended use of the aeronautical data and aeronautical information.
- (c) The verification of software is an evaluation of the output of an aeronautical data and/or aeronautical information software development process to ensure correctness and consistency

with respect to the inputs and applicable software standards, rules and conventions used in that process.

*[applicable from 27 January 2022]*

## GM2 ADR.OPS.A.055 Tools and software

*ED Decision 2021/003/R*

### TOOLS

Tools can be qualified meeting point 2.4.5 Aeronautical Data Tool Qualification of EUROCAE ED-76A/RTCA DO-200B 'Standards for Processing Aeronautical Data', dated June 2015.

*[applicable from 27 January 2022]*

## ADR.OPS.A.057 Origination of NOTAM

*Delegated Regulation (EU) 2020/2148*

- (a) The aerodrome operator shall:
- (1) establish and implement procedures in accordance with which it originates a NOTAM issued by the relevant aeronautical information services provider:
    - (i) that contains information on the establishment, condition, or change of any aeronautical facility, service, procedure or hazard, the timely knowledge of which is essential to personnel involved with flight operations;
    - (ii) that contains information of a temporary nature and of short duration or that concerns operationally significant permanent changes or temporary changes of long duration that are made at short notice, except for extensive text or graphics, or both;
  - (2) designate aerodrome personnel, who have successfully completed relevant training and demonstrated their competence, to originate NOTAM and provide relevant information to the aeronautical information service providers with which it has arrangements;
  - (3) ensure that all other aerodrome personnel whose duties involve the use of NOTAM have successfully completed relevant training and demonstrated their competence to do so.
- (b) The aerodrome operator shall originate a NOTAM when it is necessary to provide the following information:
- (1) establishment of, closure of, or significant changes in the operation of aerodromes or heliports or runways;
  - (2) establishment of, withdrawal of, or significant changes in the operation of the aerodrome services;
  - (3) establishment of, withdrawal of, or significant changes in the operational capability of radio navigation and air-ground communication services for which the aerodrome operator is responsible;
  - (4) unavailability of backup and secondary systems, having a direct operational impact;
  - (5) establishment of, withdrawal of, or significant changes to visual aids;
  - (6) interruption of, or return to operation of, major components of aerodrome lighting systems;

- (7) establishment of, withdrawal of, or significant changes to procedures for air navigation services for which the aerodrome operator is responsible;
  - (8) occurrence or correction of major defects or impediments in the manoeuvring area;
  - (9) changes to, and limitations on, the availability of fuel, oil and oxygen;
  - (10) establishment of, withdrawal of, or return to, operation of hazard beacons marking obstacles to air navigation;
  - (11) planned laser emissions, laser displays and search lights in the aerodrome surroundings, if pilots' night vision is likely to be impaired;
  - (12) erecting or removal of, or changes to, obstacles to air navigation in the takeoff, climb, missed approach, approach areas, as well as on the runway strip;
  - (13) changes in aerodrome or heliport rescue and firefighting category;
  - (14) presence of, removal of, or significant changes in, hazardous conditions due to snow, slush, ice, radioactive material, toxic chemicals, volcanic ash deposition or water on the movement area;
  - (15) presence of a runway or portion thereof which is slippery wet;
  - (16) presence of a runway which is not available due to runway marking works; or information about the time lag required for making the runway available, if the equipment used for such works can be removed, when necessary;
  - (17) presence of hazards that affect air navigation, including presence of wildlife, obstacles, displays and major events.
- (c) For the purposes of point (b), the aerodrome operator shall ensure that:
- (1) NOTAM is originated with sufficient lead time for the affected parties to take any required action, except in the case of unserviceability, release of radioactive material, toxic chemicals and other events that cannot be foreseen;
  - (2) a NOTAM notifying unserviceability of associated facilities, services and navigation aids at the aerodrome, provides an estimate of the unserviceability period or of the time at which restoration of service is expected;
  - (3) within three months from the issuance of a permanent NOTAM, the information contained in the NOTAM is included in the aeronautical information products affected;
  - (4) within three months from the issuance of a temporary NOTAM of long duration, the information contained in the NOTAM is included in an AIP supplement;
  - (5) when a NOTAM with an estimated end of validity unexpectedly exceeds the three-month period, a replacement NOTAM is originated unless the condition is expected to last for a further period of more than three months; in that case, the aerodrome operator shall ensure that the information is published in an AIP supplement.
- (d) In addition, the aerodrome operator shall ensure that:
- (1) except as provided for in point (d)(4), each NOTAM it originates contains the applicable information in the order shown in the NOTAM Format set out in Appendix 1 to this Annex;
  - (2) NOTAM text is composed of the significations or uniform abbreviated phraseology assigned to the ICAO NOTAM Code, complemented by ICAO abbreviations, indicators, identifiers, designators, call signs, frequencies, figures and plain language;

- (3) a NOTAM is originated in the English language or the national language, as agreed with the relevant aeronautical information services provider;
- (4) information concerning snow, slush, ice, frost, standing water or water associated with snow, slush, ice or frost on the movement area is disseminated by means of SNOWTAM and contains the information in the order shown in the SNOWTAM Format set out in Appendix 2 to this Annex;

*[applicable from 12 August 2021]*

- (5) when an error has occurred in a NOTAM, a NOTAM with a new number is originated to replace the erroneous NOTAM or the erroneous NOTAM is cancelled and a new NOTAM is originated;
  - (6) when a NOTAM is originated to cancel or replace a previous NOTAM:
    - (a) the series and number/year of the previous NOTAM are indicated;
    - (b) the Location Indicators and subject of both NOTAM are the same;
  - (7) only one NOTAM is cancelled or replaced by a new NOTAM;
  - (8) each originated NOTAM deals with only one subject and one condition of the subject;
  - (9) each originated NOTAM is as brief as possible and compiled so that its meaning is clear without the need to refer to another document;
  - (10) an originated NOTAM containing permanent or temporary information of long duration includes appropriate references to the AIP or AIP supplement;
  - (11) the ICAO Location Indicator included in the text of an originated NOTAM for the aerodrome is the one contained in the Location Indicators. A curtailed form of such indicators shall not be used.
- (e) The aerodrome operator shall, following the publication of a NOTAM that it has originated, review its content to ensure its accuracy, and ensure the dissemination of the information to all relevant aerodrome personnel and organisations at the aerodrome.
- (f) The aerodrome operator shall maintain records:
- (1) of the NOTAM it originated and those that were issued;
  - (2) regarding the implementation of points (a)(2) and (3).

## AMC1 ADR.OPS.A.057(a)(1) Origination of NOTAM

ED Decision 2021/003/R

### GENERAL

The procedures should as a minimum:

- (a) define the ways and means that the aerodrome operator may use to request the issuance of a NOTAM, in accordance with the arrangements that the aerodrome operator has with the aeronautical information service (AIS) provider(s). The procedures should clearly indicate the names of the aerodrome operator's personnel that have the authority to originate a NOTAM, and which should be included in the arrangements with the AIS provider.
- (b) contain instructions regarding the:
  - (1) cases when a NOTAM should be originated by the aerodrome operator;

- (2) cases when a NOTAM should not be originated by the aerodrome operator; and
  - (3) completion of the NOTAM form (including the use of relevant electronic applications, if applicable) by the personnel designated by the aerodrome operator as NOTAM originators; and
- (c) specify the cases in which coordination with the Competent Authority is needed prior to the origination of the NOTAM, and the way to inform the Competent Authority about the issuance of a NOTAM.

## AMC1 ADR.OPS.A.057(a)(2);(3) Origination of NOTAM

ED Decision 2021/003/R

### INITIAL TRAINING FOR AERODROME PERSONNEL INVOLVED IN NOTAM ORIGINATION AND OTHER AERODROME PERSONNEL

- (a) The theoretical part of the training of a person to be designated as a NOTAM originator should, as a minimum, cover the following areas:
- (1) regulatory framework governing NOTAM origination and issuance, and its relationship with other aeronautical data products, including:
    - (i) cases when the origination of a NOTAM is required;
    - (ii) cases when a NOTAM should not be originated.
  - (2) NOTAM form completion, including word abbreviations and phrase contractions applicable to NOTAMs;
  - (3) NOTAM types and understanding of NOTAM;
  - (4) use of electronic applications for initiating a NOTAM (if applicable); and
  - (5) aerodrome procedures for origination and internal dissemination of a NOTAM.

The theoretical training should be followed by an assessment of the trainees (see [AMC1 ADR.OR.D.017\(e\)](#)).

- (b) Following the successful completion of the theoretical training, the practical part of the training should, as a minimum, include familiarisation with the origination of NOTAM and implementation of the relevant aerodrome operating procedures for the persons to be designated as NOTAM originators. Upon completion of the practical training, and the successful competency assessment of the trainee in practical terms, the person may be designated as a NOTAM originator.
- (c) For other aerodrome personnel, whose duties require only the understanding of a NOTAM, the theoretical part of the training should be adjusted to their needs and need not include (a)(4) and (a)(5) above, while the practical training should include practical examples to assess the level of their understanding. Both the theoretical and the practical training should be followed by an assessment of the person concerned (see [AMC1 ADR.OR.D.017\(e\)](#)).

## GM1 ADR.OPS.A.057(a)(2);(3) Origination of NOTAM

ED Decision 2021/003/R

### RECURRENT, REFRESHER AND CONTINUATION TRAINING

[ADR.OR.D.017](#) point (f) regulates the provision of training following the completion of the initial training, as part of the aerodrome operator's training programme. For the process that needs to be

followed to ensure the continued competence of the personnel involved in NOTAM origination and use, see [ADR.OR.D.017\(f\)](#) and [AMC1 ADR.OR.D.017\(f\)](#).

## GM1 ADR.OPS.A.057(b) Origination of NOTAM

ED Decision 2021/003/R

### NON-ORIGINATION OF NOTAM

Promulgation of information through NOTAM is required under certain circumstances. In such cases, the responsible organisation (e.g. Competent Authority, aerodrome operator, air traffic services provider, etc.) originates a NOTAM, which is finally issued by the AIS provider. [ADR.OPS.A.057](#) defines the responsibilities of the aerodrome operator with respect to the NOTAM origination process, while its point (b) requires the origination of a NOTAM by the aerodrome operator in the cases prescribed in it.

On the other hand, for a variety of reasons (e.g. prevention of information overflow), not all kinds of information are eligible for promulgation through NOTAM. To this end, [Regulation \(EU\) 2017/373](#), which applies to AIS providers, prescribes in AIS.TR.330 the cases where the AIS provider shall (or shall not) issue a NOTAM.

This means that there are cases in which, even if an aerodrome operator originates a NOTAM to promulgate information, the NOTAM will not be finally issued by the AIS provider if this information is not allowed to be promulgated by NOTAM as per AIS.TR.330. To avoid such situations, the aerodrome operator needs to:

- (a) ensure that the relevant aerodrome operator's personnel are adequately trained in the relevant regulatory framework regarding both the origination and issuance of NOTAM;
- (b) develop robust procedures regarding NOTAM origination by its personnel; and
- (c) maintain close cooperation with the relevant AIS provider.

The following are example cases where the aerodrome operator will not originate a NOTAM:

- (a) routine maintenance work on aprons and taxiways that does not affect the safe movement of aircraft;
- (b) temporary obstructions in the vicinity of aerodromes/heliports that do not affect the safe operation of aircraft;
- (c) partial failure of aerodrome/heliport lighting facilities where such a failure does not directly affect aircraft operations;
- (d) partial temporary failure of air-ground communications when suitable alternative frequencies are available and are operative;
- (e) lack of apron marshalling services, road traffic closures, limitations and control;
- (f) unserviceability of location, destination or other instruction signs on the aerodrome movement area;
- (g) training activities performed by ground units;
- (h) unavailability of backup and secondary systems if these systems do not have an operational impact;
- (i) limitations to aerodrome facilities or general services with no operational impact;
- (j) announcements or warnings about possible/potential limitations with no operational impact;



- (k) general reminders on already published information;
- (l) availability of equipment for ground units, without information on the operational impact on airspace and facility users;
- (m) information about laser emissions with no operational impact and about fireworks below the minimum flying heights;
- (n) closure of parts of the movement area in connection with locally coordinated, planned work of duration of less than 1 hour;
- (o) closure, changes, unavailability in the operation of aerodrome(s)/heliport(s) other than in the aerodrome(s)/heliport(s) operation hours; and
- (p) other non-operational information of a similar temporary nature.

Information which relates to an aerodrome and its vicinity and which does not affect its operational status may be distributed locally during pre-flight or in-flight briefing or other local contact with flight crews. Thus, in case of need, the aerodrome operator may disseminate such type of information through the AIS provider it has arrangements with.

## GM2 ADR.OPS.A.057(b) Origination of NOTAM

ED Decision 2021/003/R

### PRESENCE OF WILDLIFE

The permanent presence of wildlife is to be contained in the AIP, whereas the notification of hazardous wildlife activity at short notice needs to be promulgated by NOTAM.

When originating such a NOTAM, specific bird-related abbreviations should be avoided to facilitate readability and to prevent queries.

## GM1 ADR.OPS.A.057(d)(1) Origination of NOTAM

ED Decision 2021/003/R

### NOTAM FORMAT

Information on the completion of a NOTAM format may be found in Chapter 6 of ICAO Doc 8126 'Aeronautical Information Services Manual'.

Information on the ICAO NOTAM code and abbreviations to be used may be found in ICAO Doc 8400 'Procedures for Air Navigation Services - ICAO Abbreviations and Codes' (PANS ABC).

## GM1 ADR.OPS.A.057(d)(4) Origination of NOTAM

ED Decision 2021/003/R

### SNOWTAM FORMAT

The way to complete correctly a SNOWTAM format when initiating a SNOWTAM is indicated below.

1. General
  - (a) When reporting on more than one runway, repeat Items B to H (aeroplane performance calculation section).
  - (b) The letters used to indicate items are only used for reference purposes and should not be included in the messages. The letters M (mandatory), C (conditional) and O (optional) mark the usage and information and should be included as explained below.

- (c) Metric units should be used, and the unit of measurement shall not be reported.
- (d) The maximum validity of SNOWTAM is 8 hours. A new SNOWTAM should be issued whenever a new RCR is received.
- (e) A SNOWTAM cancels the previous SNOWTAM.
- (f) The abbreviated heading 'TTAAiiii CCCC MMYGGgg (BBB)' is included to facilitate the automatic processing of SNOWTAM messages in computer databanks. The explanation of these symbols is:

TT = data designator for SNOWTAM = SW;

AA = geographical designator for Member States, e.g. LF = FRANCE;

iiii = SNOWTAM serial number in a four-digit group;

CCCC = four-letter location indicator of the aerodrome to which the SNOWTAM refers;

MMYYGGgg = date/time of observation/measurement, whereby:

MM = month, e.g. January = 01, December = 12;

YY = day of the month;

GGgg = time in hours (GG) and minutes (gg) UTC;

(BBB) = optional group for:

Correction, in the case of an error, to a SNOWTAM message previously disseminated with the same serial number = COR.

*Brackets in (BBB) are used to indicate that this group is optional.*

*When reporting on more than one runway and individual dates/times of observation/assessment are indicated by the repeated Item B, the latest date/time of observation/assessment is inserted in the abbreviated heading (MMYYGGgg).*

- (g) The text 'SNOWTAM' in the SNOWTAM Format and the SNOWTAM serial number in a four-digit group is separated by a space, e.g. SNOWTAM 0124.
- (h) For readability purposes for the SNOWTAM message, a linefeed would be included after the SNOWTAM serial number, after Item A, and after the aeroplane performance calculation section.
- (i) When reporting on more than one runway, repeat the information in the aeroplane performance calculation section from the date and time of assessment for each runway before the information in the situational awareness section.
- (j) Mandatory information is:
  - (1) AERODROME LOCATION INDICATOR;
  - (2) DATE AND TIME OF ASSESSMENT;
  - (3) LOWER RUNWAY DESIGNATOR NUMBER;
  - (4) RUNWAY CONDITION CODE FOR EACH RUNWAY THIRD; and
  - (5) CONDITION DESCRIPTION FOR EACH RUNWAY THIRD (when RWYCC is reported 1-5)

## 2. Aeroplane performance calculation section

Item A — Aerodrome location indicator (four-letter location indicator).

Item B — Date and time of assessment (eight-figure date/time group giving time of observation as month, day, hour and minute in UTC).

Item C — Lower runway designator number (nn[L] or nn[C] or nn[R]).

*Only one runway designator should be inserted for each runway and always the lower number.*

Item D — RWYCC for each runway third. Only one digit (0, 1, 2, 3, 4, 5 or 6) is inserted for each runway third, separated by an oblique stroke (n/n/n).

Item E — Per cent coverage for each runway third. When provided, insert 25, 50, 75 or 100 for each runway third, separated by an oblique stroke ([n]nn/[n]nn/[n]nn).

*This information is provided only when the runway condition for each runway third (Item D) has been reported as other than 6 and there is a condition description for each runway third (Item G) that has been reported other than 'DRY'.*

*When the conditions are not reported, this is signified by the insertion of 'NR' for the appropriate runway third(s).*

Item F — Depth of loose contaminant for each runway third. When provided, insert in millimetres for each runway third, separated by an oblique stroke (nn/nn/nn or nnn/nnn/nnn).

*This information is only provided for the following contamination types:*

- *standing water, value to be reported 04, then assessed value. Significant changes 3 mm;*
- *slush, value to be reported 03, then assessed value. Significant changes 3 mm;*
- *wet snow, value to be reported 03, then assessed value. Significant changes 5 mm; and*
- *dry snow, value to be reported 03, then assessed value. Significant changes 20 mm.*
- *When the conditions are not reported, this is signified by the insertion of 'NR' for the appropriate runway third(s).*

Item G — Condition description for each runway third. Any of the following condition descriptions for each runway third, separated by an oblique stroke, is inserted.

COMPACTED SNOW

DRY SNOW

DRY SNOW ON TOP OF COMPACTED SNOW

DRY SNOW ON TOP OF ICE

FROST

ICE

SLIPPERY WET

SLUSH

SPECIALLY PREPARED WINTER RUNWAY

STANDING WATER

WATER ON TOP OF COMPACTED SNOW

WET

WET ICE

WET SNOW

WET SNOW ON TOP OF COMPACTED SNOW

WET SNOW ON TOP OF ICE

DRY (only reported when there is no contaminant)

*When the conditions are not reported, this is signified by the insertion of 'NR' for the appropriate runway third(s).*

Item H — Width of runway to which the RWYCCs apply. The width in metres if less than the published runway width is inserted.

### 3. Situational awareness section

*Elements in the situational awareness section end with a full stop.*

*Elements in the situational awareness section for which no information exists, or where the conditional circumstances for publication are not fulfilled, are left out completely.*

Item I — Reduced runway length. The applicable runway designator and available length in metres is inserted (e.g. RWY nn [L] or nn [C] or nn [R] REDUCED TO [n]nnn).

*This information is conditional when a NOTAM has been published with a new set of declared distances.*

Item J — Drifting snow on the runway. When reported, the lower runway designator is inserted with a space 'DRIFTING SNOW' (RWY nn or RWY nn[L] or nn[C] or nn[R] DRIFTING SNOW).

Item K — Loose sand on the runway. When loose sand is reported on the runway, the lower runway designator is inserted with a space 'LOOSE SAND' (RWY nn or RWY nn[L] or nn[C] or nn[R] LOOSE SAND).

Item L — Chemical treatment on the runway. When application of chemical treatment has been reported, the lower runway designator is inserted with a space 'CHEMICALLY TREATED' (RWY nn or RWY nn[L] or nn[C] or nn[R] CHEMICALLY TREATED).

Item M — Snowbanks on the runway. When snowbanks are reported present on the runway, the lower runway designator is inserted with a space 'SNOWBANK' and with a space left 'L' or right 'R' or both sides 'LR', followed by the distance in metres from centre line separated by a space 'FM CL' (RWY nn or RWY nn[L] or nn[C] or nn[R] SNOWBANK Lnn or Rnn or LRnn FM CL).

Item N — Snowbanks on a taxiway. When snowbanks are present on taxiway(s), the taxiway(s) designator(s) is (are) inserted with a space 'SNOWBANKS' (TWY [nn]n or TWYS [nn]n/[nn]n/[nn]n/... or ALL TWYS SNOWBANKS).

Item O — Snowbanks adjacent to the runway. When snowbanks are reported present, penetrating the height profile in the aerodrome snow plan, the lower runway designator and 'ADJ SNOWBANKS' are inserted (RWY nn or RWY nn[L] or nn[C] or nn[R] ADJ SNOWBANKS).

Item P — Taxiway conditions. When taxiway conditions are reported slippery or poor, the taxiway designator followed by a space 'POOR' is inserted (TWY [n or nn] POOR or TWYS [n or nn]/[n or nn]/... POOR or ALL TWYS POOR).

Item R — Apron conditions. When apron conditions are reported slippery or poor, the apron designator followed by a space 'POOR' is inserted (APRON [nnnn] POOR or APRONS [nnnn]/[nnnn]/... POOR or ALL APRONS POOR).

Item S — NR (not reported).

Item T — Plain-language remarks.

*[applicable from 12 August 2021]*

## GM2 ADR.OPS.A.057(d)(4) Origination of NOTAM

*ED Decision 2021/003/R*

### SNOWTAM FORMAT

Below are four examples of completed SNOWTAMs.

#### Example SNOWTAM 1

```
GG EADBZQZX EADNZQZX EADSZQZX  
170100 EADDYNYX  
SWEA0149 EADD 02170055  
(SNOWTAM 0149  
EADD  
02170055 09L 5/5/5 100/100/100 NR/NR/03 WET/WET/WET SNOW)
```

#### Example SNOWTAM 2

```
GG EADBZQZX EADNZQZX EADSZQZX  
170140 EADDYNYX  
SWEA0150 EADD 02170135  
(SNOWTAM 0150  
EADD  
02170055 09L 5/5/5 100/100/100 NR/NR/03 WET/WET/WET SNOW  
02170135 09R 5/2/2 100/50/75 NR/06/06 WET/SLUSH/SLUSH)
```

#### Example SNOWTAM 3

```
GG EADBZQZX EADNZQZX EADSZQZX  
170229 EADDYNYX  
SWEA0151 EADD 02170225  
(SNOWTAM 0151  
EADD  
02170055 09L 5/5/5 100/100/100 NR/NR/03 WET/WET/WET SNOW  
02170135 09R 5/2/2 100/50/75 NR/06/06 WET/SLUSH/SLUSH)
```

02170225 09C 2/3/3 75/100/100 06/12/12 SLUSH/WET SNOW/WET SNOW

RWY 09L SNOWBANK R20 FM CL. RWY 09R ADJ SNOWBANKS. TWY B POOR. APRON NORTH POOR)

Example SNOWTAM 4

GG EADBZQZX EADNZQZX EADSZQZX

170350 EADDYNYX

SWEA0152 EADD 02170345

(SNOWTAM 0152

EADD

02170345 09L 5/5/5 100/100/100 NR/NR/03 WET/WET/SLUSH

02170134 09R 5/2/2 100/50/75 NR/06/06 WET/SLUSH/SLUSH

02170225 09C 2/3/3 75/100/100 06/12/12 SLUSH/WET SNOW/WET SNOW

DRIFTING SNOW. RWY 09L LOOSE SAND. RWY 09R CHEMICALLY TREATED. RWY 09C CHEMICALLY TREATED.)

*[applicable from 12 August 2021]*

## ADR.OPS.A.060 Reporting of surface contaminants

*Delegated Regulation (EU) 2020/2148*

The aerodrome operator shall report to the aeronautical information services and air traffic services units on matters of operational significance affecting aircraft and aerodrome operations on the movement area, particularly in respect of the presence of the following:

- (a) water;
- (b) snow;
- (c) slush;
- (d) ice;
- (e) frost;
- (f) anti-icing or de-icing liquid chemicals or other contaminants;
- (g) snowbanks or drifts.

*[applicable from 12 August 2021]*

## ADR.OPS.A.065 Reporting of the runway surface condition

*Delegated Regulation (EU) 2020/2148*

- (a) The aerodrome operator shall report the runway surface condition over each third of the runway using a runway condition report (RCR). The report shall include a runway condition code (RWYCC) using numbers 0 to 6, the contaminant coverage and depth, and a description using the following terms:

- (1) COMPACTED SNOW;
- (2) DRY;

- (3) DRY SNOW;
  - (4) DRY SNOW ON TOP OF COMPACTED SNOW;
  - (5) DRY SNOW ON TOP OF ICE;
  - (6) FROST;
  - (7) ICE;
  - (8) SLIPPERY WET;
  - (9) SLUSH;
  - (10) SPECIALLY PREPARED WINTER RUNWAY;
  - (11) STANDING WATER;
  - (12) WATER ON TOP OF COMPACTED SNOW;
  - (13) WET;
  - (14) WET ICE;
  - (15) WET SNOW;
  - (16) WET SNOW ON TOP OF COMPACTED SNOW;
  - (17) WET SNOW ON TOP OF ICE;
  - (18) CHEMICALLY TREATED;
  - (19) LOOSE SAND.
- (b) Reporting shall commence when a significant change in runway surface condition occurs due to water, snow, slush, ice or frost.
- (c) Reporting of the runway surface condition shall continue to reflect significant changes until the runway is no longer contaminated. When that situation occurs, the aerodrome operator shall issue an RCR that states that the runway is wet or dry as appropriate.
- (d) Friction measurements shall not be reported.
- (e) When a paved runway or portion thereof is slippery wet, the aerodrome operator shall make such information available to the relevant aerodrome users. That shall be done by originating a NOTAM and shall describe the location of the affected portion.

*[applicable from 12 August 2021]*

## AMC1 ADR.OPS.A.065(a) Reporting of the runway surface condition

*ED Decision 2021/003/R*

### REPORTING

The aerodrome operator should disseminate an RCR through the aeronautical information services and air traffic services, when the runway is wholly or partly contaminated by standing water, snow, slush, ice or frost, or is wet associated with the clearing or treatment of snow, slush, ice or frost. When the runway is wet, not associated with the presence of standing water, snow, slush, ice or frost, the assessed information should be disseminated using the RCR through the air traffic service.

*[applicable from 12 August 2021]*

## AMC2 ADR.OPS.A.065(a) Reporting of the runway surface condition

ED Decision 2021/003/R

### RUNWAY CONDITION REPORT

- (a) The RCR should consist of the:
- (1) aeroplane performance calculation section; and
  - (2) situational awareness section.
- (b) The information should be included in an information string in the following order:
- (1) aeroplane performance calculation section:
    - (i) aerodrome location indicator;
    - (ii) date and time of assessment;
    - (iii) lower runway designation number;
    - (iv) RWYCC for each runway third;
    - (v) per cent coverage contaminant for each runway third;
    - (vi) depth of loose contaminant for each runway third;
    - (vii) condition description for each runway third; and
    - (viii) width of runway to which the RWYCCs apply if less than the published width.
  - (2) Situational awareness section:
    - (i) reduced runway length;
    - (ii) drifting snow on the runway;
    - (iii) loose sand on the runway;
    - (iv) chemical treatment on the runway;
    - (v) snowbanks on the runway;
    - (vi) snowbanks on the taxiway;
    - (vii) snowbanks adjacent to the runway;
    - (viii) taxiway conditions;
    - (ix) apron conditions; and
    - (x) plain-language remarks.

*[applicable from 12 August 2021]*

## GM1 ADR.OPS.A.065(a) Reporting of the runway surface condition

ED Decision 2021/003/R

### GENERAL

- (a) Assessing and reporting the condition of the movement area and related facilities is necessary in order to provide the flight crew with the information needed for safe operation of the aeroplane. The RCR is used for reporting assessed conditions through the issuance of SNOTAM, when necessary.



- (b) Generally, movement areas are exposed to a multitude of climatic conditions and consequently there is a significant difference in the conditions to be reported. The RCR describes a basic structure applicable for all these climatic variations. Assessing the runway surface condition relies on a great variety of techniques and no single solution can apply to every situation.
- (c) The philosophy of the RCR is that the aerodrome operator assesses the runway surface condition whenever water, snow, slush, ice or frost are present on an operational runway. From this assessment, a RWYCC and a description of the runway surface are reported, which can be used by the flight crew for aeroplane performance calculations. This format, based on the type, depth and coverage of contaminants, is the best assessment of the runway surface condition by the aerodrome operator; however, all other pertinent information is taken into consideration and kept up to date, and changes in conditions are reported without delay.
- (d) The RWYCC reflects the runway braking capability as a function of the surface conditions. With this information, the flight crew can derive, from the performance information provided by the aeroplane manufacturer, the necessary stopping distance of an aircraft on the approach under the prevailing conditions.

[applicable from 12 August 2021]

## GM2 ADR.OPS.A.065(a) Reporting of the runway surface condition

ED Decision 2021/003/R

### RUNWAY CONDITION REPORT

#### AEROPLANE PERFORMANCE CALCULATION SECTION

- (a) The aeroplane performance calculation section is a string of grouped information, separated by a space ' ' ending with a return and a two-line feed '<<≡', in order to distinguish the aeroplane performance calculation section from the following situational awareness section or the following aeroplane performance calculation section of another runway.
- (b) The information to be included in this section consists of the following:
  - (1) **Aerodrome location indicator:** a four-letter ICAO location indicator in accordance with ICAO Doc 7910 'Location Indicators'.  
This information is mandatory.  
Format: nnnn
  - (2) **Date and time of the assessment:** date and time (UTC) when the assessment was performed.  
This information is mandatory.  
Format: MMDDhhmm
  - (3) **Lower runway designation number:** a two- or three-character number identifying the runway for which the assessment is carried out and reported.  
This information is mandatory.  
Format: nn[L] or nn[C] or nn[R]
  - (4) **Runway condition code for each runway third:** a one-digit number identifying the RWYCC assessed for each runway third. The codes are reported in a three-character group separated by a '/' for each third. The direction for listing the runway thirds is the direction as seen from the lower designation number.

This information is mandatory.

When transmitting information on the runway surface condition by air traffic services to flight crews, the sections are, however, referred to as the first, second or third part of the runway. The first part always means the first third of the runway as seen in the direction of landing or take-off as illustrated in Figures 1 and 2.

Format: n/n/n

Example: 5/5/2

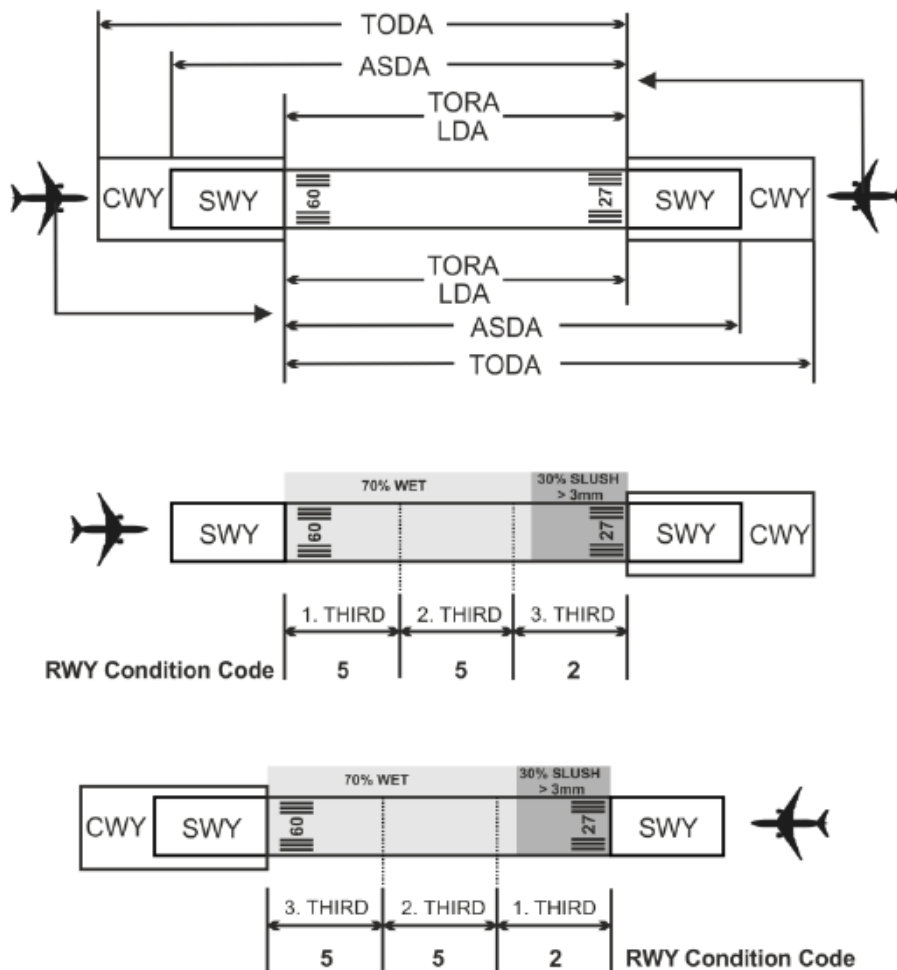
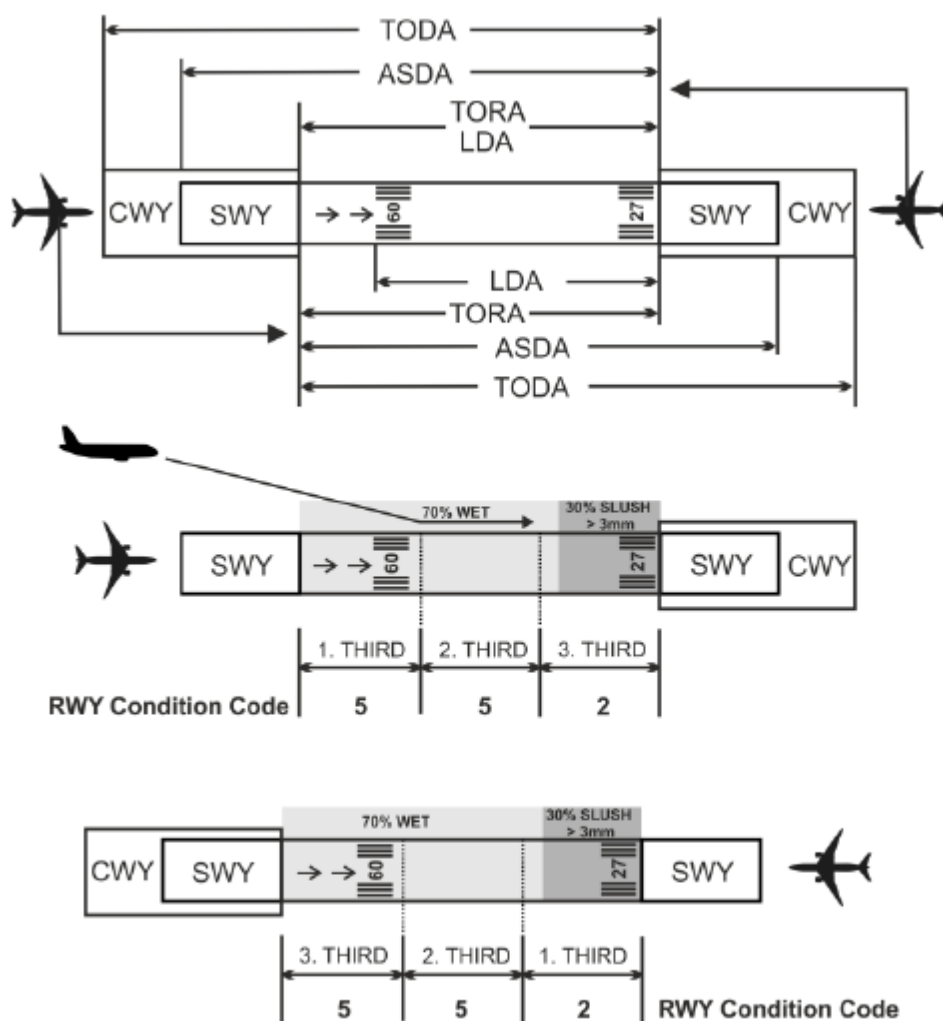


Figure 1: Reporting of RWYCC  
from air traffic services to flight crew for runway thirds



*Figure 2: Reporting of RWYCC  
 for runway thirds from air traffic services to flight crew on a runway with displaced threshold*

- (5) **Per cent coverage contaminant for each runway third:** a number identifying the percentage coverage. The percentages are to be reported in an up-to-nine character group separated by a '/' for each runway third. The assessment is based upon an even distribution within the runway thirds using Table 1.

This information is conditional. It is not reported for any runway third that is dry or covered with less than 10 per cent.

Format: [n]nn/[n]nn/[n]nn

Example: 25/50/100

In case of uneven distribution of the contaminants, additional information is given in the plain-language remark part of the situational awareness section of the RCR. Where possible, a standardised text is used.

When no information is to be reported, 'NR' is inserted at the relevant position of the message, to indicate to the user that no information exists.

- (6) **Depth of loose contaminant:** dry snow, wet snow, slush or standing water for each runway third: a two- or three-digit number representing the assessed depth (mm) of the contaminant for each runway third. The depth is reported in a six-to nine-character group separated by a '/' for each runway third as defined in Table 2 of [AMC1 ADR.OPS.A.065\(b\);\(c\)](#). The assessment is based upon an even distribution within the runway thirds following an assessment. If measurements are included as part of the assessment process, the reported values are still reported as assessed depths.

This information is conditional. It is reported only for DRY SNOW, WET SNOW, SLUSH and STANDING WATER.

Format: [n]nn/[n]nn/[n]nn

- (7) **Condition description for each runway third:** to be reported in capital letters using the terms specified in ADR.OPS.A.065 point (a). The condition types are separated by an oblique stroke '/'.

This information is mandatory.

Format: nnnn/nnnn/nnnn

- (8) **Width of runway to which the RWYCCs apply if less than the published width:** two-digit number representing the width of cleared runway in metres.

This information is conditional.

Format: nn

If the cleared runway width is not symmetrical along the centre line, additional information is given in the plain-language remark part of the situational awareness section of the RCR.

#### SITUATIONAL AWARENESS SECTION

- (a) All individual messages in the situational awareness section end with a full-stop sign, in order to distinguish the message from subsequent message(s).
- (b) The information to be included in this section consists of the following:

(1) **Reduced runway length**

The information is conditional when a NOTAM has been published with a new set of declared distances affecting the landing distance available (LDA).

Format: Standardised fixed text – RWY nn [L] or nn [C] or nn [R] LDA REDUCED TO [n]nnn

(2) **Drifting snow on the runway**

This information is conditional.

Format: Standardised fixed text – RWY nn [L] or nn [C] or nn[R] DRIFTING SNOW

(3) **Loose sand on the runway**

This information is conditional.

Format: RWY nn[L] or nn[C] or nn[R] LOOSE SAND

(4) **Chemical treatment on the runway**

This information is conditional.

Format: RWY nn[L] or nn[C] or nn[R] CHEMICALLY TREATED

(5) **Snowbanks on the runway**

This information is conditional.

Left or right distance in metres from centre line.

Format: RWY nn[L] or nn[C] or nn[R] SNOWBANK Lnn or Rnn or LRnn FM CL

(6) **Snowbanks on taxiway**

This information is conditional.

Format: TWY [nn]n or TWYS [nn]n/[nn]n/[nn]n/... or ALL TWYS SNOWBANKS

(7) **Snowbanks adjacent to the runway penetrating level/profile set in the aerodrome snow plan**

This information is conditional.

Format: RWY nn[L] or nn[C] or nn[R] ADJ SNOWBANKS

(8) **Taxiway conditions**

This information is optional.

Format: TWY [nn]n POOR or TWYS[nn]n/[nn]n/... POOR or ALL TWYS POOR

(9) **Apron conditions**

This information is conditional.

Format: APRON [nnnn] POOR or APRONS[nnnn]/[nnnn]/... POOR or ALL APRONS POOR

(10) **Plain-language remarks using only allowable characters in capital letters**

Where possible, standardised text is used.

This information is optional except for the conditional information 'UPGRADED' or 'DOWNGRADED' used whenever the assessed RWYCC differs from what follows directly from the runway condition assessment matrix (RCAM). When present, this information is to be the first piece of information of the plain language remarks in order to ease readability and to recognise its importance as part of the situational awareness prior to aeroplane performance calculations.

Format: Combination of allowable characters where use of full stop '.' marks the end of the message.

Allowable characters:

A B C D E F G H I J K L M N O P Q R S T U V W X Y Z

0 1 2 3 4 5 6 7 8 9

/ [oblique stroke] ' [period] ' [space]

If ICE, SNOW or SNOW ON ICE affects only the runway edge, the following text may be used:

RWY nn[L] or nn[C] or nn[R] ICE or SNOW or SNOW ON ICE Lnn or Rnn or LRnn FM EDGE

*[applicable from 12 August 2021]*

## GM3 ADR.OPS.A.065(a) Reporting of the runway surface condition

ED Decision 2021/003/R

### COMPLETE INFORMATION STRING

An example of a complete information string prepared for dissemination is as follows:

*COM header and abbreviated header] (Completed by AIS)*

GG EADBZQZX EADNZQZX EADSZQZX

070645 EADDYNYX

SWEA0151 EADD 02170055

SNOWTAM 0151

*[Aeroplane performance calculation section]*

EADD 02170055 09L 5/5/5 100/100/100 NR/NR/NR WET/WET/WET

EADD 02170135 09R 5/2/2 100/50/75 NR/06/06 WET/SLUSH/SLUSH

EADD 02170225 09C 2/3/3 75/100/100 06/12/12 SLUSH/WET SNOW/WET SNOW

*[Situational awareness section]*

RWY 09L SNOWBANK R20 FM CL. RWY 09R ADJ SNOWBANKS. TWY B POOR. APRON NORTH POOR.

*[applicable from 12 August 2021]*

## GM4 ADR.OPS.A.065(a) Reporting of the runway surface condition

ED Decision 2021/003/R

### REPORTING BY AERODROMES WITH MULTIPLE RUNWAYS

On aerodromes with multiple runways, SNOWTAM includes all the runways, in case that at least one runway is contaminated. This improves pilots' situational awareness and support their decision on the selection of the landing/take-off runway.

*[applicable from 12 August 2021]*

## GM1 ADR.OPS.A.065(a)(18);(19) Reporting of the runway surface condition

ED Decision 2021/003/R

### REPORTING OF CHEMICALLY TREATED AND LOOSE SAND

The terms 'CHEMICALLY TREATED' and 'LOOSE SAND' do not appear in the aeroplane performance calculation section but are used in the situational awareness section of the RCR.

*[applicable from 12 August 2021]*

## AMC1 ADR.OPS.A.065(b);(c) Reporting of the runway surface condition

ED Decision 2021/003/R

### SIGNIFICANT CHANGES

A change in the runway surface condition used in the RCR should be considered significant whenever there is any:

- (a) change in the RWYCC;
- (b) change in the contaminant type;
- (c) change in reportable contaminant coverage according to Table 1;
- (d) change in contaminant depth according to Table 2; and
- (e) other information, for example a SPECIAL AIR-REPORT of runway braking action, which according to assessment techniques used, is known to be significant.

Assessed per cent	Reported per cent
10-25	25
26-50	50
51-75	75
76-100	100

Table 1: Percentage of coverage for contaminants

Contaminant	Valid values to be reported	Significant change
STANDING WATER	04, then assessed value	3 mm
SLUSH	03, then assessed value	3 mm
WET SNOW	03, then assessed value	5 mm
DRY SNOW	03, then assessed value	20 mm

Table 2: Depth assessments for contaminants

Note 1: For STANDING WATER, 04 (4 mm) is the minimum depth value at and above which the depth should be reported. From 3 mm and below, the runway third should be considered WET.

Note 2: For SLUSH, WET SNOW and DRY SNOW, depths up to and including 3 mm should be reported as 03 (3 mm).

Note 3: Above 4 mm for STANDING WATER and above 3 mm for SLUSH, WET SNOW and DRY SNOW, an assessed value should be reported and a significant change relates to the observed change from this assessed value.

[applicable from 12 August 2021]

## GM1 ADR.OPS.A.065(b);(c) Reporting of the runway surface condition

ED Decision 2021/003/R

### EXAMPLE OF REPORTING DEPTH OF CONTAMINANT WHENEVER THERE IS A SIGNIFICANT CHANGE

- (a) After the first assessment of runway condition, a first RCR is generated. The initial report is:

5/5/5 100/100/100 03/03/03 SLUSH/SLUSH/SLUSH

Note: The full information string is not used in this example.

- (b) With continuing precipitation, a new RCR is required to be generated as a subsequent assessment reveals that the depth of contamination has increased from 3 mm to 5 mm along the entire length of the runway and therefore a change in the RWYCC is needed. A second RCR is therefore created as:

2/2/2 100/100/100 05/05/05 SLUSH/SLUSH/SLUSH

- (c) With even more precipitation, a further assessment reveals that the depth of contamination has increased from 5 mm to 7 mm along the entire length of the runway. However, a new RCR is not required because the RWYCC has not changed (change in depth is less than the significant change threshold of 3 mm).

- (d) A final assessment of the contamination reveals that the depth has increased to 10 mm. A new RWYCC is required because the change in depth from the last RCR (second RWYCC), i.e. from 5 mm to 10 mm is greater than the significant change threshold of 3 mm. A third RCR is thus created as below:

2/2/2 100/100/100 10/10/10 SLUSH/SLUSH/SLUSH

For contaminants other than STANDING WATER, SLUSH, WET SNOW or DRY SNOW, the depth is not reported. The position of this type of information in the information string is then identified by /NR/.

When the depth of the contaminants varies significantly within a runway third, additional information is to be given in the plain-language remark part of the situational awareness section of the RCR.

*[applicable from 12 August 2021]*

## GM1 ADR.OPS.A.065(d) Reporting of runway surface condition

*ED Decision 2021/003/R*

### USE OF FRICTION MEASUREMENTS

Friction measurements cannot be used by flight crews to determine landing performance requirements, because there is no correlation between the measurements and aeroplane performance data. Nevertheless, continuous friction measuring devices may be used, together with all other available means, to support upgrade or downgrade of the RWYCC, by using friction measurements in a comparative way and not as absolute values.

*[applicable from 12 August 2021]*



## APPENDIX 1 — NOTAM FORMAT

*Delegated Regulation (EU) 2020/2148*

Priority indicator											→	
Address												
											<<=	
Date and time of filing											→	
Originator's indicator											<<=(	
Message series, number and identifier												
NOTAM containing new information	..... NOTAMN (series and number/year)											
NOTAM replacing a previous NOTAM	..... NOTAMR..... (series and number/year) (series and number/year of NOTAM to be replaced)											
NOTAM cancelling a previous NOTAM	..... NOTAMC..... (series and number/year) (series and number/year of NOTAM to be cancelled)									<<=		
Qualifiers												
	FIR	NOTAM Code	Traffic	Purpose	Scope	Lower limit	Upper limit	Coordinates, Radius				
Q)												<<=
Identification of ICAO Location Indicators in which the facility, airspace or condition reported on is located								A) →				
Period of validity												
From (date-time group)			B)								→	
To (PERM or date-time group)			C)							EST* PERM*	<<=	
Time schedule (if applicable)			D)								→	
											<<=	
Text of NOTAM; Plain-language entry (using ICAO abbreviations)												
E)											<<=	
Lower limit		F)										→
Upper limit		G)										)<<=
Signature												

\*Delete as appropriate

## APPENDIX 2 — SNOWTAM FORMAT

Delegated Regulation (EU) 2020/2148

(COM heading)	(Priority indicator)	(Addresses)		<≡
	(Date and time of filing)	(Originator's indicator)		<≡
(Abbreviated heading)	(SWAA* SERIAL NUMBER)	(LOCATION INDICATORS)	DATE-TIME OF ASSESSMENT	(OPTIONAL GROUP)
	S W * *			
SNOWTAM →		(Serial number)	<≡	
<b>Aeroplane performance calculation section</b>				
(AERODROME LOCATION INDICATORS)	M	A)		<≡
(DATE/TIME OF ASSESSMENT <i>(Time of completion of assessment in UTC)</i> )	M	B)		→
(LOWER RUNWAY DESIGNATION NUMBER)	M	C)		→
(RUNWAY CONDITION CODE (RWYCC) ON EACH RUNWAY THIRD) (From Runway Condition Assessment Matrix (RCAM) 0, 1, 2, 3, 4, 5 or 6)	M	D)	//	→
(PER CENT COVERAGE CONTAMINANT FOR EACH RUNWAY THIRD)	C	E)	//	→
DEPTH (mm) OF LOOSE CONTAMINANT FOR EACH RUNWAY THIRD	C	F)	//	→
(CONDITION DESCRIPTION OVER TOTAL RUNWAY LENGTH (Observed on each runway third, starting from threshold having the lower runway designation number)  COMPACTED SNOW DRY DRY SNOW DRY SNOW ON TOP OF COMPACTED SNOW DRY SNOW ON TOP OF ICE FROST ICE SLIPPERY WET SLUSH SPECIALLY PREPARED WINTER RUNWAY STANDING WATER WATER ON TOP OF COMPACTED SNOW WET WET ICE WET SNOW WET SNOW ON TOP OF COMPACTED SNOW WET SNOW ON TOP OF ICE	M	G)	//	→
(WIDTH OF RUNWAY TO WHICH THE RUNWAY CONDITIONS CODES APPLY, IF LESS THAN THE PUBLISHED WIDTH)	O	H)	<≡≡	
<b>Situational awareness section</b>				
(REDUCED RUNWAY LENGTH, IF LESS THAN THE PUBLISHED LENGTH (m))	O	I)		→
(DRIFTING SNOW ON THE RUNWAY)	O	J)		→
(LOOSE SAND ON THE RUNWAY)	O	K)		→
(CHEMICAL TREATMENT ON RUNWAY)	O	L)		→
(SNOWBANKS ON THE RUNWAY) (If present, distance from runway centreline (m) followed by 'L', 'R' or 'LR' as applicable))	O	M)		→
(SNOWBANKS ON A TAXIWAY)	O	N)		→
(SNOWBANKS ADJACENT TO THE RUNWAY)	O	O)		→
(TAXIWAY CONDITIONS)	O	P)		→
(APRON CONDITIONS)	O	R)		→
(MEASURED FRICTION COEFFICIENT)	O	S)		→
(PLAIN-LANGUAGE REMARKS)	O	T)		) <<≡
NOTES: 1. *Enter ICAO nationality letters as given in ICAO Doc 7910, Part 2 or otherwise applicable aerodrome identifier. 2. Information on other runways, repeat from B to H. 3. Information in the situational awareness section repeated for each runway, taxiway and apron. Repeat as applicable, when reported. 4. Words in brackets () not to be transmitted. 5. For letters A) to T), refer to the <i>Instructions for the completion of the SNOWTAM format, paragraph 1, item b)</i> .				

SIGNATURE OF ORIGINATOR (not for transmission)

## **SUBPART B — AERODROME OPERATIONAL SERVICES, EQUIPMENT AND INSTALLATIONS (ADR.OPS.B)**

### **ADR.OPS.B.001 Provision of services**

*Regulation (EU) No 139/2014*

The services under Subpart B of this Annex shall be provided at the aerodrome by the aerodrome operator directly or indirectly.

### **GM1 ADR.OPS.B.001 Provision of services**

*ED Decision 2014/012/R*

#### **SERVICES**

The services included in Part B of this Annex, need to be provided at an aerodrome. In some cases, these services are not directly provided by the aerodrome operator, but by another organisation or State entity or combination of both. However, the aerodrome operator, being responsible for the operation of the aerodrome should have arrangements and interfaces with these organisations or entities to ensure that these services are provided according to the legal requirements. The method described above meets with the intention of an integrated Safety Management System that helps the aerodrome operator to ensure the safety objective of the service provision is being met. In completing this action, the aerodrome operator should hereby be seen to discharge its responsibility by employing the procedures mentioned above, furthermore, the aerodrome operator should not be understood to be directly responsible or liable for non-compliances by another entity involved in the arrangement.

### **ADR.OPS.B.003 Handover of activities — provision of operational information**

*Delegated Regulation (EU) 2020/2148*

- (a) The aerodrome operator shall establish and implement procedures for the handover of operational activities between personnel involved in the operation and maintenance of the aerodrome to ensure that all new incoming personnel are provided with operational information related to their tasks.
- (b) The aerodrome operator shall establish and implement procedures to provide organisations operating or providing services at the aerodrome, with aerodrome-related operational information that may affect the execution of the tasks of the personnel of such organisations.

### **AMC1 ADR.OPS.B.003(a) Handover of activities — provision of operational information**

*ED Decision 2021/003/R*

#### **HANDOVER OF OPERATIONAL ACTIVITIES — PERSONNEL BRIEFING**

- (a) The aerodrome operator procedures for the handover of operational activities should as a minimum:

- (1) cover the change of a shift within the same function (e.g. between RFFS personnel), as well as the case where a task is handed over to another person within the same shift, and the cases where an activity is handed over between different functions (e.g. from maintenance to operations);
  - (2) address the case when a planned activity (e.g. light maintenance) is not completed at the time of a planned shift change; or any other non-regular activity is in place; and
  - (3) allow for the preparation of both outgoing and incoming personnel.
- (b) The briefing should be in a manner that allows effective two-way communication between the outgoing and incoming personnel, during which all task-relevant information necessary for the incoming personnel is provided to them, both verbally and in writing. In the case of posts which are not continually manned, or aerodromes with interrupted working hours, the briefing may be in writing, while ensuring that additional information may be provided to the incoming personnel in case of such need.
- (c) The briefing of drivers and other operational personnel operating on the manoeuvring area should, as a minimum, include:
- (1) the runway(s) in use;
  - (2) any significant works areas in place, or being established or removed that day;
  - (3) conditions of stop bars, if applicable, that may be inoperable making a taxiway unusable for runway entry or crossing; and
  - (4) if low-visibility procedures are in force.

## **GM1 ADR.OPS.B.003(b) Handover of activities — provision of operational information**

*ED Decision 2021/003/R*

### **PROVISION OF OPERATIONAL INFORMATION TO OTHER ORGANISATIONS**

Given that changes of the operating conditions at an aerodrome may affect all personnel operating on the movement area, there is a need to ensure that the personnel of other organisations which operate or provide services at the aerodrome are also provided with the necessary operational information, which pertains to their operating environment.

Therefore, the aerodrome operator needs to provide this type of information to such organisations, so that they are enabled to relay it to their own personnel. It is important that there is no delay in the provision of such information by the aerodrome operator, and that it is done in a manner prearranged with the other organisations, to ensure it reaches its destination.

Such information may include changes in the operating conditions on the apron (e.g. due to works or occurrences) or on the manoeuvring area, or other facilities of the aerodrome. For the type of information that may be provided regarding the manoeuvring area, see point (c) of [AMC1 ADR.OPS.B.003\(a\)](#).

## **ADR.OPS.B.005 Aerodrome emergency planning**

*Regulation (EU) No 139/2014*

The aerodrome operator shall have and implement an aerodrome emergency plan that:

- (a) is commensurate with the aircraft operations and other activities conducted at the aerodrome;
- (b) provides for the coordination of appropriate organisations in response to an emergency occurring at an aerodrome or in its surroundings; and
- (c) contains procedures for periodic testing of the adequacy of the plan and for reviewing the results in order to improve its effectiveness.

### **AMC1 ADR.OPS.B.005(b) Aerodrome emergency planning**

*ED Decision 2014/012/R*

#### **GENERAL**

- (a) The aerodrome operator should ensure that the aerodrome emergency plan includes the ready availability of, and coordination with, appropriate specialist rescue services to be able to respond to emergencies where an aerodrome is located close to water and/or swampy areas, and where a significant portion of approach or departure operations takes place over these areas.
- (b) The aerodrome operator should ensure that an assessment of the approach and departure areas within 1000 m of the runway threshold is carried out to determine the options available for intervention.

### **AMC2 ADR.OPS.B.005(b) Aerodrome emergency planning**

*ED Decision 2014/012/R*

#### **AERODROME EMERGENCY PLAN DOCUMENT**

The aerodrome operator should include, at least, the following in the aerodrome emergency plan document:

- (a) Types of emergencies planned for;
- (b) Agencies involved in the plan, and details of the aerodrome and local emergency planning arrangements and forums;
- (c) Responsibility and role of each agency, the emergency operations centre, and the command post for each type of emergency;
- (d) Information on names and telephone numbers of offices or people to be contacted in the case of a particular emergency; and
- (e) A grid map of the aerodrome and its immediate surroundings, approximately at a distance of 8 km from the centre of the aerodrome.

### **AMC1 ADR.OPS.B.005(c) Aerodrome emergency planning**

*ED Decision 2014/012/R*

#### **AERODROME EMERGENCY EXERCISE**

The aerodrome operator should ensure that the emergency plan is tested with:

- (a) a full-scale aerodrome emergency exercise at intervals not exceeding two years; and
- (b) partial emergency exercises in the intervening year to ensure that any deficiencies found during the full-scale aerodrome emergency exercise have been corrected

and reviewed thereafter, or after an actual emergency, so as to correct any deficiency found during such exercises or actual emergency.

## **GM1 ADR.OPS.B.005(a) Aerodrome emergency planning**

*ED Decision 2014/012/R*

### **PURPOSE OF THE AERODROME EMERGENCY PLAN**

- (a) In many cases the aerodrome emergency plan is part of a National or Local Emergency Plan, and the responsibility for its development is assigned to another entity, different from the aerodrome operator. However, this does not prevent the aerodrome operator from preparing its own plan describing the actions that should be taken during an emergency, in cooperation with the authorities which are responsible for the National or Local Emergency Plan.
- (b) Irrespective of whose responsibility is the establishment and implementation of an emergency plan covering emergencies at or in the surroundings of an aerodrome, the emergency plan should ensure that there are provisions for:
  - (1) orderly and efficient transition from normal to emergency operations;
  - (2) delegation of authority;
  - (3) assignment of emergency responsibilities;
  - (4) authorising key personnel for actions contained in the plan;
  - (5) coordination of efforts to cope with the emergency; and
  - (6) safe continuation of aircraft operations or return to normal operations as soon as possible.

## **GM2 ADR.OPS.B.005(a) Aerodrome emergency planning**

*ED Decision 2014/012/R*

### **AERODROME EMERGENCY PLAN DOCUMENT**

- (a) The aerodrome emergency plan of the aerodrome operator should observe human factors principles to ensure optimum response in emergency operations.
- (b) In order to ensure that the aerodrome emergency plan document fully serves its purpose, it should include the following:
  - (1) plans for dealing with emergencies occurring at the aerodrome or in its surroundings, including the malfunction of aircraft in flight; structural fires; sabotage, including bomb threats (aircraft or structure); unlawful seizure of aircraft; and incidents on the aerodrome covering 'during the emergency' and 'after the emergency' considerations;
  - (2) details of tests for aerodrome facilities and equipment to be used in emergencies such as emergency operations centre, mobile command post, fire fighting vehicles and equipment, communication means, first aid medical supplies, etc., including the frequency of those tests;
  - (3) details of exercises to test emergency plans, including the frequency of those exercises;

- (4) a list of organisations, agencies, and persons of authority, both on and off-aerodrome, for site roles; their telephone and fax numbers, e-mail and SITA addresses, and the radio frequencies of their offices;
- (5) the establishment of an aerodrome emergency committee to organise training and other preparations for dealing with emergencies;
- (6) the appointment of an on-the-scene commander for the overall emergency operation; and
- (7) Details of the off aerodrome areas for which the aerodrome RFFS will provide a response, and the size and nature of the response.

## **GM3 ADR.OPS.B.005(a) Aerodrome emergency planning**

*ED Decision 2014/012/R*

### **CONTENTS OF AN AERODROME EMERGENCY PLAN DOCUMENT**

The purpose of the aerodrome Emergency Plan Document is to provide all the required information to agencies and staff involved in an emergency. The document should be structured in such a manner, that the required information is easily identifiable. For that purpose, the structure of the aerodrome emergency plan should be as follows:

#### **Section 1 — Emergency telephone numbers**

This section should be limited to essential telephone, numbers according to the aerodrome needs, including:

- (a) air traffic services unit;
- (b) rescue and firefighting services (fire departments);
- (c) airfield operations department;
- (d) police and security;
- (e) medical services:
  - (1) hospitals;
  - (2) ambulances; and
  - (3) doctors — business/residence;
- (f) aircraft operators;
- (g) ground handling agencies;
- (h) government authorities;
- (i) civil defence; and
- (j) others.

#### **Section 2 — Aircraft accident on the aerodrome**

- (a) Action by air traffic services unit;
- (b) Action by rescue and firefighting services;
- (c) Action by police and security services;

- (d) Action by the aerodrome operator:
  - (1) vehicle escort; and
  - (2) maintenance;
- (e) Action by medical services:
  - (1) hospitals;
  - (2) ambulances;
  - (3) doctors; and
  - (4) medical personnel.
- (f) Action by aircraft operator involved;
- (g) Action by emergency operations centre and mobile command post;
- (h) Action by government authorities;
- (i) Communication network (emergency operations centre and mobile command post);
- (j) Action by agencies organisations involved in mutual aid emergency agreements;
- (k) Action by transportation authorities (land, sea, air);
- (l) Action by public information officer(s);
- (m) Action by local fire departments when structures involved; and
- (n) Action by all other agencies.

**Section 3 — Aircraft accident off the aerodrome**

- (a) Action by air traffic services unit;
- (b) Action by rescue and firefighting services;
- (c) Action by local fire departments;
- (d) Action by police and security services;
- (e) Action by aerodrome operator;
- (f) Action by medical services:
  - (i) hospitals;
  - (ii) ambulances;
  - (iii) doctors; and
  - (iv) medical personnel.
- (g) Action by agencies involved in mutual aid emergency agreements;
- (h) Action by aircraft operator involved;
- (i) Action by emergency operations centre and mobile command post;
- (j) Action by government authorities;
- (k) Action by communication networks (emergency operations centre and mobile command post);
- (l) Action by transportation authorities (land, sea, air);



- (m) Action by public information officer; and
- (n) Action by all other agencies.

**Section 4 — Malfunction of aircraft in flight (Full emergency or local standby)**

- (a) Action by air traffic services unit;
- (b) Action by aerodrome rescue and firefighting services;
- (c) Action by police and security services;
- (d) Action by the aerodrome operator;
- (e) Action by medical services:
  - (1) hospitals;
  - (2) ambulances;
  - (3) doctors; and
  - (4) medical personnel.
- (f) Action by aircraft operator involved;
- (g) Action by emergency operations centre and mobile command post; and
- (h) Action by all other agencies.

**Section 5 — Structural fires**

- (a) Action by air traffic services unit;
- (b) Action by rescue and firefighting services (local fire department);
- (c) Action by police and security services;
- (d) Action by aerodrome authority;
- (e) Evacuation of structure;
- (f) Action by medical services:
  - (1) hospitals;
  - (2) ambulances;
  - (3) doctors; and
  - (4) medical personnel.
- (g) Action by emergency operations centre and mobile command post;
- (h) Action by public information officer; and
- (i) Action by all other agencies.

**Section 6 — Sabotage including bomb threat (aircraft or structure)**

- (a) Action by air traffic services unit;
- (b) Action by emergency operations centre and mobile command post;
- (c) Action by police and security services;
- (d) Action by the aerodrome operator;

- (e) Action by rescue and firefighting services;
- (f) Action by medical services:
  - (1) hospitals;
  - (2) ambulances;
  - (3) doctors; and
  - (4) medical personnel.
- (g) Action by aircraft operator involved;
- (h) Action by government authorities;
- (i) Isolated aircraft parking position;
- (j) Evacuation;
- (k) Searches by dogs and trained personnel;
- (l) Handling and identification of luggage and cargo on board aircraft;
- (m) Handling and disposal of suspected bomb;
- (n) Action by public information officer; and
- (o) Action by all other agencies.

**Section 7 — Unlawful seizure of aircraft**

- (a) Action by air traffic services unit;
- (b) Action by rescue and firefighting services;
- (c) Action by police and security services;
- (d) Action by the aerodrome operator;
- (e) Action by medical services:
  - (1) hospitals;
  - (2) ambulances;
  - (3) doctors; and
  - (4) medical personnel.
- (f) Action by aircraft operator involved;
- (g) Action by government authorities;
- (h) Action by emergency operations centre and mobile command post;
- (i) Isolated aircraft parking position;
- (j) Action by public information officer; and
- (k) Action by all other agencies.

**Section 8 — Incident on the aerodrome**

An incident on the aerodrome could require any, or all of the actions detailed in Section 2, 'Aircraft accident on the aerodrome'. Examples of incidents the aerodrome operator should consider to

include: fuel spills at the ramp, passenger loading bridge, and fuel storage area; dangerous goods occurrences at freight handling areas; collapse of structures; vehicle/aircraft collisions; etc.

### **Section 9 — Persons of authority — site roles**

To include, but not limited to, the following, according to local requirements:

- (a) On-aerodrome:
  - (1) Aerodrome chief fire officer;
  - (2) Aerodrome authority;
  - (3) Police and security — Officer-in-charge; and
  - (4) Medical coordinator.
- (b) Off-aerodrome:
  - (1) Local chief fire officer;
  - (2) Government authority; and
  - (3) Police and security — officer-in-charge.

The on-the-scene commander will be designated as required from within the pre-arranged mutual aid emergency agreement.

## **GM4 ADR.OPS.B.005(a) Aerodrome emergency planning**

*ED Decision 2014/012/R*

### **TYPES OF EMERGENCIES**

- (a) At least the following types of emergencies may be included in the aerodrome emergency plan:
  - (1) Aircraft emergencies;
  - (2) Aircraft ground incidents, where an aircraft on the ground is known to have an emergency situation other than an accident, requiring the attendance of emergency services;
  - (3) Sabotage, including bomb threats;
  - (4) Unlawfully seized aircraft;
  - (5) Dangerous goods occurrences;
  - (6) Building fires;
  - (7) Natural disasters; and
  - (8) Public health emergencies.
- (b) The aircraft emergencies for which services may be required are generally classified as:
  - (1) ‘aircraft accident’: an aircraft accident which has occurred on or in the aerodrome surroundings;
  - (2) ‘full emergency’: an aircraft approaching the aerodrome is, or is suspected to be, in such trouble that there is imminent danger of an accident; and

- (3) 'local standby': an aircraft approaching the aerodrome is known. or is suspected to have developed some defect, but the trouble is not such as would normally involve any serious difficulty in effecting a safe landing.

## GM5 ADR.OPS.B.005(a) Aerodrome emergency planning

*ED Decision 2014/012/R*

### DISABLED AIRCRAFT REMOVAL

- (a) The aerodrome operator should establish a plan for the removal of an aircraft disabled on, or adjacent to, the movement area, and a coordinator designated to implement the plan, when necessary.
- (b) The disabled aircraft removal plan should be based on the characteristics of the aircraft that may normally be expected to operate at the aerodrome, and include among other things:
- (1) a list of equipment and personnel on, or in the surroundings of, the aerodrome which would be available for such purpose; and
  - (2) arrangements for the rapid receipt of aircraft recovery equipment kits available from other aerodromes;

## GM1 ADR.OPS.B.005(b) Aerodrome emergency planning

*ED Decision 2014/012/R*

### COORDINATION WITH OTHER AGENCIES AND ORGANISATIONS

- (a) The aerodrome emergency plan should describe the procedures for coordinating the response of different aerodrome agencies organisations or services (e.g. ground handlers, airlines, security services) and those agencies in the surrounding community that could be of assistance in responding to an emergency.
- (b) If the aerodrome emergency plan is not part of a National or Local Emergency Plan, then it should be coordinated as required.
- (c) Emergency mutual aid agreements should be established to define responsibilities and/or liabilities of each external agency responding to an emergency. These agreements should include the following:
- (1) clarification of the political and jurisdictional responsibilities of the several agencies (e.g. police, local fire fighting services, local authorities, accident investigation bodies, etc.) that could be involved in order to avoid problems when an emergency occurs;
  - (2) establishment of the command authority; i.e. a single on-the-scene commander (with designated alternates if necessary);
  - (3) designation of communication priorities at the accident site;
  - (4) organisation of emergency transportation facilities under (a) pre-designated coordinator(s);
  - (5) predetermination of the legal authorities and liabilities of all cooperating emergency personnel; and
  - (6) pre-arrangements for use of portable and heavy rescue equipment from available sources.

- (d) The aerodrome emergency plan should be implemented similarly whether it is an on-aerodrome or an off-aerodrome aircraft accident/incident.
- (e) Rendezvous signs and directional arrows should be consistent, and conform to national standards.
- (f) The aerodrome operator should assess the level of medical supplies to be held on the aerodrome for emergency purposes.

## **GM2 ADR.OPS.B.005(b) Aerodrome emergency planning**

*ED Decision 2014/012/R*

### **INVOLVED AGENCIES IN EMERGENCIES**

The following agencies could participate in response to an emergency, depending on the type of emergency and local arrangements:

- (a) On the aerodrome:
  - (1) Air Traffic Control Unit;
  - (2) Rescue and firefighting services;
  - (3) Aerodrome administration;
  - (4) Medical and ambulance services;
  - (5) Aircraft operators;
  - (6) Ground handling agencies;
  - (7) Security services; and
  - (8) Police.
- (b) Off the aerodrome:
  - (1) Fire departments;
  - (2) Police;
  - (3) Health authorities (including medical, ambulance, hospital and public health services);
  - (4) Military; and
  - (5) Harbour or coast guard, if applicable.

## **GM3 ADR.OPS.B.005(b) Aerodrome emergency planning**

*ED Decision 2014/012/R*

### **EMERGENCY OPERATIONS CENTRE**

- (a) The practice had shown that emergencies are handled more efficiently centrally through an emergency operations centre and a command post.
- (b) The emergency operations centre could be a part of the aerodrome facilities, and responsible for the overall coordination and general direction of the response to an emergency. Depending on the size of the aerodrome and local procedures, more than one emergency centres could be established, but within the aerodrome emergency plan should be identified which of them has the overall responsibility for coordination.

- (c) A person should be assigned to assume control of the emergency operations centre and, when appropriate, another person the command post.
- (d) The role of the emergency operations centre should be to support the on-the-scene commander in the mobile command post for aircraft accidents/incidents.
- (e) The emergency operations centre, depending on relevant security plans and local procedures could be the command, coordination, and communication centre for unlawful seizure of aircraft and bomb threats.
- (f) The emergency operations centre should be operationally available 24 hours a day, or during the aerodrome's hours of operation, and procedures should be established for notifying its staff.
- (g) The location of the emergency operation centre is very important for its efficiency. Consideration should be given to establish its location having a clear view of the movement area and isolated aircraft parking position, wherever possible.
- (h) Adequate equipment and personnel should be available in order to communicate with the appropriate agencies involved in the emergency, including the mobile post, when this is deployed. The communication and electronic devices should be checked regularly, to identify any malfunctions.

## **GM4 ADR.OPS.B.005(b) Aerodrome emergency planning**

*ED Decision 2014/012/R*

### **MOBILE COMMAND POST**

- (a) The command post is a facility capable of being moved rapidly to the site of an emergency, when required, and undertakes the local coordination of those agencies responding to the emergency.
- (b) The mobile command post, when established, should contain the necessary equipment and personnel to communicate with all agencies involved in the emergency, including the emergency operations centre. The communication and electronic devices should be checked regularly, in order to identify any malfunctions.
- (c) Maps, charts, and other relevant equipment and information should be available at the mobile command post.

## **GM5 ADR.OPS.B.005(b) Aerodrome emergency planning**

*ED Decision 2014/012/R*

### **COMMUNICATION SYSTEMS USED FOR EMERGENCIES**

- (a) When established, adequate communication systems linking the command post and the emergency operations centre with each other and with the participating agencies should be provided in accordance with the plan and consistent with the particular requirements of the aerodrome.
- (b) The communication systems used should include a sufficient number of radio transceivers, telephones, and other communication devices to establish and maintain a primary, and a secondary means of communication;

- (c) The role of the communication systems is to provide a primary, and, where necessary, an alternate means for effective direct communications between the following, as applicable:
- (1) the alerting authority and the rescue and firefighting (RFF) units serving the aerodrome;
  - (2) air traffic services unit, the appropriate fire department alarm room/dispatch centre(s) and the firefighting and rescue crews en route to an aircraft emergency and at the accident/incident site;
  - (3) appropriate mutual aid agencies located on or off the aerodrome, including an alert procedure for all auxiliary personnel expected to respond; and
  - (4) the RFF vehicles, including a communication capability between crew members on each RFF vehicle.
- (d) A communications system should be established in order to provide rapid response of the emergency equipment to accidents and incidents occurring in the terminal areas, and at the apron. Apron accidents include aircraft cabin fires, refuelling spills and fires, aircraft and vehicle collisions, and medical emergencies.
- (e) Communication systems used during emergencies should be tested regularly to verify the operability of all radio and telephone networks.
- (f) A complete and current list of interagency telephone numbers should be available to all agencies and to personnel responsible for the aerodrome emergency plan, to ensure rapid notification in case of emergencies. These phone numbers should be verified frequently to ensure they are correct. Updated lists should be distributed to all emergency plan participants on a continual basis.

## **GM1 ADR.OPS.B.005(c) Aerodrome emergency planning**

*ED Decision 2014/012/R*

### **EMERGENCIES IN DIFFICULT ENVIRONMENT**

At those aerodromes located close to water and/or swampy areas, or difficult terrain, the aerodrome emergency plan should include the establishment, testing, and assessment at regular intervals of a predetermined response for the specialist rescue services.

## **GM2 ADR.OPS.B.005(c) Aerodrome emergency planning**

*ED Decision 2014/012/R*

### **EMERGENCY EXERCISES**

- (a) Full-scale exercises
- (1) The purpose of a full-scale exercise is to ensure the adequacy of the plan to cope with different types of emergencies.
  - (2) Full-scale emergency exercises should be supported by all aerodrome and community authorities concerned.
  - (3) Objectives of the exercise should be defined.
  - (4) Involved departments and agencies should be thoroughly familiar with the aerodrome emergency plan, and develop individual plans in coordination with the general plan.

- (5) The emergency exercises should be held in locations which will provide maximum realism while ensuring minimum disruption of the aerodrome operations. Different scenarios, as described in the aerodrome emergency plan document, should be used. The exercise could be held either during the day or at night on the aerodrome, and at different times of the year when seasonal changes may present additional challenges. Exercises may take place both on or near the aerodrome to test different scenarios.
  - (6) In order to obtain the maximum benefit from a full-scale emergency exercise, the entire proceedings should be reviewed. An observer critique team should be organised, comprised of members who are familiar with mass casualty accident proceedings. Each member of the critique team should observe the entire exercise, and complete the appropriate emergency drill critique forms. As soon as convenient after the exercise, a critique meeting should be held so members of the team can present their observations and recommendations for improvement of the aerodrome emergency plan procedures and associated aerodrome emergency plan document.
  - (7) The exercise should be followed by a full debriefing, critique, and analysis. It is important that representatives of all organisations which participate in the exercise actively participate in the critique.
- (b) Partial emergency exercises
- (1) The purpose of a partial exercise is to ensure the adequacy of the response to individual participating agencies and components of the plan.
  - (2) Partial emergency exercises should involve, at least, one unit, such as rescue and firefighting services, or medical, or combination of several units, as appropriate.
  - (3) Partial emergency exercises should ensure that any deficiencies found during the full-scale aerodrome emergency exercise have been corrected.
- (c) Tabletop exercises
- Tabletop exercises should be held at regular intervals. The aim of these exercises should be to verify that roles and procedures are clear and understood. These exercises offer a good opportunity to test new or revised procedures, before implementation, or preparation for a full-scale emergency exercise.

## **ADR.OPS.B.010 Rescue and firefighting services**

*Delegated Regulation (EU) 2020/2148*

- (a) The aerodrome operator shall ensure that:
- (1) aerodrome rescue and firefighting facilities, equipment and services are provided;
  - (2) adequate equipment, fire extinguishing agents and sufficient personnel are available in a timely manner;
  - (3) rescue and firefighting personnel are properly trained, equipped and qualified to operate in the aerodrome environment; and
  - (4) rescue and firefighting personnel potentially required to act in aviation emergencies demonstrate their medical fitness to execute their functions satisfactorily, taking into account the type of activity.



- (b) The aerodrome operator shall establish and implement a training programme for persons involved in rescue and firefighting services of the aerodrome;
- (c) The training programme shall be conducted in accordance with [point ADR.OR.D.017](#), with the following exceptions:
  - (1) recurrent training shall include theoretical and continuous practical training;
  - (2) proficiency checks shall be conducted at intervals not exceeding 12 months since the completion of the initial training.
- (d) The training of rescue and firefighting personnel shall be designed to impart fundamental knowledge and practical skills related to the execution of their duties.
- (e) Temporary reduction of the level of protection of the aerodrome's rescue and firefighting services, due to unforeseen circumstances, shall not require prior approval by the competent authority.

## GM1 ADR.OPS.B.010(a)(1) Rescue and firefighting services

ED Decision 2016/009/R

### AVAILABILITY AND SCOPE OF RESCUE AND FIREFIGHTING SERVICES

Public or private organisations, suitably located and equipped, could be designated to provide the rescue and firefighting service. The fire station housing these organisations should normally be located on the aerodrome, although an off-aerodrome location is not precluded, provided that the response time can be met. The principal objective of rescue and firefighting services is to save lives in the event of an aircraft accident or incident occurring at, or in the immediate surroundings of, the aerodrome. The rescue and firefighting service is provided to create and maintain survivable conditions, to provide egress routes for occupants, and to initiate the rescue of those occupants unable to make their escape without direct aid. The rescue may require the use of equipment and personnel other than those assessed primarily for rescue and firefighting purposes. Ambulance and medical services are out of the scope of rescue and firefighting services as described in [ADR.OPS.B.010](#). The role and responsibilities of ambulance and medical services during an emergency situation should be included in the aerodrome emergency plan (AEP), according to [GM3 ADR.OPS.B.005\(a\)](#).

## AMC1 ADR.OPS.B.010(a)(2) Rescue and firefighting services

ED Decision 2014/012/R

### COMMUNICATION AND ALERTING SYSTEMS

The aerodrome operator should ensure that:

- (a) a discrete communication system is provided linking a fire station with the control tower, any other fire station on the aerodrome, and the rescue and firefighting vehicles;
- (b) an alerting system for rescue and firefighting personnel, capable of being operated from that station, is provided at the fire station, any other fire station on the aerodrome, and the aerodrome control tower;
- (c) means are provided for communication between the rescue and firefighting service and the flight crew of an aircraft in emergency;
- (d) communication means are provided to ensure the immediate summoning of designated personnel not on standby duty;

- (e) communication means are provided to ensure two-way communication with the rescue and firefighting vehicles in attendance at an aircraft accident or incident.
- (f) communications during emergencies should be recorded;
- (g) communication means are provided between rescue and firefighting crew members.

## AMC2 ADR.OPS.B.010(a)(2) Rescue and firefighting services

*ED Decision 2016/009/R*

### RFFS LEVEL OF PROTECTION

- (a) The aerodrome operator should ensure that:
  - (1) the level of protection normally available at an aerodrome is determined and expressed in terms of the category of the rescue and firefighting services (RFF aerodrome category) as described below and in accordance with the types, amounts, and discharge rates of extinguishing agents normally available at the aerodrome; and
  - (2) the aerodrome category for rescue and firefighting is determined according to Table 1, based on the longest aeroplanes normally using the aerodrome and their fuselage width. If, after selecting the category appropriate to the longest aeroplane's overall length, that aeroplane's fuselage width is greater than the maximum width in Table 1, column 3, for that category, then the category for that aeroplane should actually be one category higher.

Aerodrome category for rescue and fire fighting		
Aerodrome Category (1)	Aeroplane overall length (2)	Maximum fuselage width (3)
1	0 m up to but not including 9 m	2 m
2	9 m up to but not including 12 m	2 m
3	12 m up to but not including 18 m	3 m
4	18 m up to but not including 24 m	4 m
5	24 m up to but not including 28 m	4 m
6	28 m up to but not including 39 m	5 m
7	39 m up to but not including 49 m	5 m
8	49 m up to but not including 61 m	7 m
9	61 m up to but not including 76 m	7 m
10	76 m up to but not including 90 m	8 m

**Table 1**

- (3) the rescue and firefighting level of protection provided is appropriate to the aerodrome category determined using the principles in (2) above except that where the number of movements (landing or take-off) of the aeroplanes performing passenger transportation in the highest category, normally using the aerodrome, is less than 700 in the busiest consecutive three months, the level of protection provided in accordance with (2) above may be reduced by no more than one category below the determined one.
- (b) Notwithstanding (a), the aerodrome operator may, during anticipated periods of reduced activity (e.g. specific periods of the year or day), reduce the rescue and firefighting level of protection available at the aerodrome. In this case:

- (1) the level of protection should be no less than that needed for the highest category of aeroplane planned to use the aerodrome during that time, irrespective of the number of movements; and
  - (2) the periods of aerodrome operation with reduced rescue and firefighting level of protection should be published in the aeronautical information publication (AIP) or through notice to airmen (NOTAM).
- (c) The level of protection required for all-cargo, mail, ferry, training, test, positioning and end-of-life aeroplane operations, including those carrying dangerous goods, irrespective of the number of movements, may be reduced in accordance with Table 2 as follows:

Aerodrome category	RFF level of protection required
1	1
2	2
3	3
4	4
5	5
6	5
7	6
8	6
9	7
10	7

**Table 2**

- (d) The aerodrome operator, in order to assess whether the rescue and firefighting level of protection to be provided at the aerodrome is appropriate to the aerodrome rescue and firefighting category, should, at least annually, forecast the aeroplane traffic expected to operate at the aerodrome for the next twelve-month period. Upon knowledge of planned changes to traffic volume and structure, additional assessments might be necessary. In doing so, the aerodrome operator may use all information available from aeroplane operators as well as statistics on aeroplane movements during the year preceding the day of review.
- (e) Unforeseen circumstances leading to temporary reduction of the aerodrome rescue and firefighting level of protection are considered as unplanned events that result in unavailability of facilities, equipment and resources.
- (f) For emergency landings and occasions when in the pilot's-in-command opinion, a diversion or hold may create a more significant hazard, operation of aeroplanes whose required category is higher than the level of protection provided by the aerodrome should be permitted regardless of the rescue and firefighting level of protection available.

### AMC3 ADR.OPS.B.010(a)(2) Rescue and firefighting services

*ED Decision 2016/009/R*

#### NUMBER OF RFFS VEHICLES AND RESCUE EQUIPMENT

- (a) The aerodrome operator should ensure that:
  - (1) the minimum number of rescue and firefighting vehicles at the aerodrome to effectively deliver and deploy the agents specified for the aerodrome category will be in accordance with the following table; and

Aerodrome category	Rescue and firefighting vehicles
1	1
2	1
3	1
4	1
5	1
6	2
7	2
8	3
9	3
10	3

**Table 1**

- (2) rescue equipment commensurate with the level of aircraft operations is provided on the rescue and firefighting vehicles.
- (b) If the aerodrome is located near a water/swampy area, or other difficult environment, or a significant portion of the approach/departure operations takes over these areas, the aerodrome operator should coordinate the availability of suitable rescue equipment and services.

## AMC4 ADR.OPS.B.010(a)(2) Rescue and firefighting services

*ED Decision 2016/009/R*

### EXTINGUISHING AGENTS

The aerodrome operator should ensure that:

- (a) both principal and complementary extinguishing agents are provided at the aerodrome;
- (b) principal extinguishing agent includes:
- (1) a foam meeting the minimum performance level A; or
  - (2) a foam meeting the minimum performance level B; or
  - (3) a foam meeting the minimum performance level C; or
  - (4) a combination of these agents;
- except for aerodromes in categories 1 to 3, where it should preferably meet a performance level B or C foam;
- (c) the complementary extinguishing agent is a dry chemical powder suitable for extinguishing hydrocarbon fires, or any other alternate agent having equivalent firefighting capability;
- (d) the amounts of water for foam production, and of the complementary agents provided on the rescue and firefighting vehicles are in accordance with the determined aerodrome category and Table 1,

Minimum usable amounts of extinguishing agents								
Aerodrome category (1)	Foam meeting performance level A		Foam meeting performance level B		Foam meeting performance level C		Complementary agents	
	Water (L) (2)	Discharge rate foam solution/minute (L) (3)	Water (L) (4)	Discharge rate foam solution/minute (L) (5)	Water (L) (6)	Discharge rate foam solution/minute (L) (7)	Dry chemical powders (kg) (8)	Discharge rate (kg/sec) (9)
1	350	350	230	230	160	160	45	2.25
2	1 000	800	670	550	460	360	90	2.25
3	1 800	1 300	1 200	900	820	630	135	2.25
4	3 600	2 600	2 400	1800	1 700	1 100	135	2.25
5	8 100	4 500	5 400	3 000	3 900	2 200	180	2.25
6	11 800	6 000	7 900	4 000	5 800	2 900	225	2.25
7	18 200	7 900	12 100	5 300	8 800	3 800	225	2.25
8	27 300	10 800	18 200	7 200	12 800	5 100	450	4.5
9	36 400	13 500	24 300	9 000	17 100	6 300	450	4.5
10	48 200	16 600	32 300	11 200	22 800	7 900	450	4.5

Note: The quantities of water shown in columns 2, 4 and 6 are based on the average overall length of aeroplanes in a given category

**Table 1**

except that for aerodrome categories 1 and 2, up to 100 % of the water may be substituted with complementary agent.

For the purpose of agent substitution, 1 kg of complementary agent is equivalent to 1 L of water for production of a foam meeting performance level A.

Note 1: The amounts of water specified for foam production are predicated on an application rate of 8.2 L/min/m<sup>2</sup> for a foam meeting performance level A, 5.5 L/min/m<sup>2</sup> for a foam meeting performance level B and 3.75 L/min/m<sup>2</sup> for a foam meeting performance level C.

Note 2: When any other complementary agent is used, the substitution ratios need to be checked.

- (da) the quantity of foam concentrates separately provided on vehicles for foam production is in proportion to the quantity of water provided and the foam concentrate selected;
- (e) the amount of foam concentrate provided on a vehicle should be sufficient to produce, at least, two loads of foam solution;
- (f) when a combination of different performance level foams are provided at the aerodrome, the total amount of water to be provided for foam production should be calculated for each foam type and the distribution of these quantities should be documented for each vehicle and applied to the overall rescue and firefighting requirement;
- (g) the discharge rate of the foam solution is not less than the rates shown in Table 1;
- (h) the complementary agents comply with the appropriate specifications of the International Organisation for Standardisation (ISO);
- (i) the discharge rate of complementary agents is not less than the values shown in Table 1;

- (j) a reserve supply of foam concentrate equivalent to 200 % of the quantities identified in Table 1 is maintained on the aerodrome for vehicle replenishment purposes. Foam concentrate carried on fire vehicles in excess of the quantity identified in Table 1 can contribute to the reserve;
- (k) a reserve supply of complementary agent equivalent to 100% of the quantity identified in Table 1 is maintained on the aerodrome for vehicle replenishment purposes and sufficient propellant gas is included to utilize this reserve complementary agent. Complementary agent(s) carried on fire vehicles in excess of the quantity identified in Table 1 may contribute to the reserve;
- (l) for Category 1 and 2 aerodromes that have replaced up to 100% of the water with complementary agent a reserve supply of complementary agent of 200% is maintained;
- (m) where a major delay in the replenishment of the supplies is anticipated, the amount of reserve supply is increased as determined by a risk assessment;
- (n) a water need analysis is conducted to determine the availability of sufficient quantities of water for fire fighting;
- (o) quantities of water and foam concentrate are recalculated and the amount of water and foam concentrate for foam production and the discharge rates for foam solution are increased accordingly, where operations by aeroplanes larger than the average size in a given category are planned;
- (oa) Where the level of protection is reduced in accordance with [AMC2 ADR.OPS.B.010\(a\)\(2\)](#), a recalculation of quantities of extinguishing agents should be computed based on the largest aeroplane in the reduced category;
- (ob) For all-cargo, mail, training, test, positioning and end-of-life aeroplane operations, including those carrying dangerous goods, the recalculation of quantities of extinguishing agents should be based on the largest aeroplane in the category specified in Table 2 of [AMC2 ADR.OPS.B.010\(a\)\(2\)](#); and
- (p) arrangements are in place to manage extinguishing agents in terms of selection, storage, maintenance, and testing.

## **AMC5 ADR.OPS.B.010(a)(2) Rescue and firefighting services**

*ED Decision 2016/009/R*

### **RESPONSE TIME**

The aerodrome operator should ensure that:

- (a) rescue and firefighting service achieves a response time not exceeding three minutes with an operational objective of not exceeding two minutes from the time of the initial call to the rescue and firefighting services, to any point of each operational runway, in optimum visibility and surface conditions, and be in a position to apply foam at a rate of, at least, 50 % of the discharge rate specified in [AMC4 ADR.OPS.B.010](#) Table 1;
- (b) response times to any other part of the movement area, in optimum visibility and surface conditions, are calculated and included in the Aerodrome Emergency Plan;
- (c) any vehicle, other than the first responding vehicle(s), required to achieve continuous agent application of the amount of extinguishing agents specified in Table 1 of [AMC4 ADR.OPS.B.010](#) arrives no more than one minute after the first responding vehicle(s); and

- (d) suitable guidance, equipment and/or procedures for rescue and firefighting services are provided, to meet the operational objective, as nearly as possible, in less than optimum conditions of visibility, especially during low visibility operations.

## **AMC6 ADR.OPS.B.010(a)(2) Rescue and firefighting services**

*ED Decision 2014/012/R*

### **PERSONNEL**

The aerodrome operator should ensure that:

- (a) during flight operations and, at least, 15 minutes after the departure of last flight, sufficient trained personnel is detailed and readily available to ride the rescue and firefighting vehicles, and to operate the equipment at maximum capacity;
- (b) personnel is deployed in a way that ensures the minimum response times can be achieved, and continuous agent application at the appropriate rate can be fully maintained considering also the use of hand lines, ladders, and other rescue and firefighting equipment normally associated with aircraft rescue and firefighting operations;
- (c) all responding rescue and firefighting personnel are provided with protective clothing and respiratory equipment to enable them to perform their duties in an effective manner; and
- (d) any other duties carried out by rescue and firefighting personnel do not compromise the response, or their safety.

## **GM1 ADR.OPS.B.010(a)(2) Rescue and firefighting services**

*ED Decision 2014/012/R*

### **COMMUNICATION AND ALERTING SYSTEMS**

The aerodrome operator should examine the possibility of utilizing means allowing the direct communication between the rescue and fire fighting service and the flight crew of an aircraft in emergency. The decision could be based on the ability of the rescue and fire fighting personnel to communicate effectively with the flight crew either verbally or using hand signals. Two-way radio communication system may be used as well as the hand signals described in Appendix 1 of Commission Implementing Regulation (EU) No 923/2012.

## **GM2 ADR.OPS.B.010(a)(2) Rescue and firefighting services**

*ED Decision 2014/012/R*

### **NUMBER OF RFFS PERSONNEL**

In determining the number of personnel required to provide for rescue and firefighting, a Task and Resource Analysis should be performed, taking into consideration the types of aircraft operating at the aerodrome, the available rescue and firefighting vehicles and equipment, any other duties required from RFFS personnel, etc.

## GM3 ADR.OPS.B.010(a)(2) Rescue and firefighting services

ED Decision 2014/012/R

### NUMBER OF RFFS VEHICLES AND RESCUE EQUIPMENT

Special fire fighting equipment may not be provided for water areas; this does not prevent the provision of such equipment if it would be of practical use, such as when the areas concerned include reefs or islands. The objective should be to plan and deploy the necessary life-saving flotation equipment, as expeditiously as possible, in a number commensurate with the largest aeroplane normally using the aerodrome.

## GM4 ADR.OPS.B.010(a)(2) Rescue and firefighting services

ED Decision 2016/009/R

### REDUCTION OF RFFS LEVEL OF PROTECTION

Contingency arrangements to limit the need for changes to the promulgated rescue and firefighting level of protection should be developed. This may involve, for example, a maintenance plan to ensure the mechanical efficiency of equipment and vehicles for rescue and firefighting, and arrangements to cover unplanned absence of the minimum level of personnel including supervisory levels.

The following may be considered as unforeseen circumstances leading to temporary reduction of the level of protection of the aerodrome rescue and firefighting:

- (a) breakdown of RFFS vehicles;
- (b) staff shortage;
- (c) unavailability of extinguishing agents; and
- (d) RFFS response to an accident.

Such changes, including estimated time of the reduction, should be notified without delay to the appropriate air traffic services (ATS) units and aeronautical information services (AIS) units (see [GM1 ADR.OPS.A.005](#) Aerodrome data) to enable those units to provide the necessary information to arriving and departing aircraft.

A temporary reduction should be expressed in terms of the new category of the rescue and firefighting services available at the aerodrome. Where the temporary reduction involves resources not used to calculate the aerodrome RFF category (e.g. specialist rescue equipment for difficult environs), details should be notified. When such a temporary reduction no longer applies, the above units should be advised accordingly.

## GM5 ADR.OPS.B.010(a)(2) Rescue and firefighting services

ED Decision 2016/009/R

### RESCUE AND FIREFIGHTING LEVEL OF PROTECTION

The following examples are intended to illustrate the way in which the various factors to be taken into account when calculating levels of protection should be applied:

#### Example 1 — Wider aeroplane fuselage

If an aeroplane has a fuselage length of 47.5 m, column 2 of Table 1 in [AMC2 ADR.OPS.B.010\(a\)\(2\)](#) indicates RFF category 7. However, the example aeroplane has a fuselage width of 5.5 m, therefore, according to (a)(2) in [AMC2 ADR.OPS.B.010\(a\)\(2\)](#), the appropriate level of protection is RFF category 8.



### Example 2 — Longer than average aeroplane length

Where operations by aeroplanes larger than the average size in a given category are planned, the quantities of water should be recalculated, and the amount of water for foam production as well as the discharge rates for foam solution should be increased accordingly. The example below is based on an aeroplane with an overall length of 48 m and a maximum fuselage width of 5 m. The quantity of water and the discharge rate of foam solution have been calculated using the ICAO critical-area concept, and increased to reflect the greater practical critical area.

Minimum useable amounts of extinguishing agents (based on the provision of foam meeting performance level B)			
Aerodrome category	Water (lt)	Discharge rate of foam solution (lt/min)	Dry chemical powder(kg)
Category 7 minimum requirement	12 100	5 300	225
Requirement following recalculation	14 113	6 163	225

### Example 3 — Less than 700 movements in the busiest consecutive 3 months

The following examples illustrate the method for the determination of the aerodrome’s rescue and firefighting level of protection when considering the number of movements:

Aeroplane	Overall length	Fuselage width	Category	Movements
Airbus A320	37.6 m	4.0 m	6	600
Bombardier CRJ 900	36.4 m	2.7 m	6	300
Embraer 190	36.2 m	3.0 m	6	500
ATR 72	27.2 m	2.8 m	5	200

The longest aeroplanes are categorised by evaluating, based on Table 1 of [AMC2 ADR.OPS.B.010\(a\)\(2\)](#), firstly their overall length and secondly their fuselage width until 700 movements are reached. It may be seen that the number of movements of the longest aeroplanes in the highest category totals more than 700. The aerodrome, in this case, is category 6.

Aeroplane	Overall length	Fuselage width	Category	Movements
Airbus A350-900	66.8 m	6.0 m	9	300
Boeing 747-8	76.3 m	6.5 m	10	400
Airbus A380	72.7 m	7.1 m	10	400

The longest aeroplanes are categorised by evaluating, based on Table 1 of [AMC2 ADR.OPS.B.010\(a\)\(2\)](#), firstly their overall length and secondly their fuselage width until 700 movements are reached. It may be seen that the number of movements of the longest aeroplanes in the highest category totals more than 700. It may also be noted that when evaluating the category appropriate to the overall length of Airbus A380, e.g. category 9, the category selected is actually one level higher as the aeroplane’s fuselage width is greater than the maximum fuselage width for category 9. The aerodrome, in this case, is category 10.

Aeroplane	Overall length	Fuselage width	Category	Movements
Boeing 737-900ER	42.1 m	3.8 m	7	300
Bombardier CRJ 900	36.4 m	2.7 m	6	500

<b>Airbus A319</b>	33.8 m	4.0 m	6	300
--------------------	--------	-------	---	-----

The longest aeroplanes are categorised by evaluating, based on Table 1 of [AMC2 ADR.OPS.B.010\(a\)\(2\)](#), firstly their overall length and secondly their fuselage width until 700 movements are reached. It may be seen that the number of movements of the longest aeroplanes in the highest category totals only 300. The minimum category for the aerodrome, in this case, is category 6, which is one category level below that of the longest aeroplane.

Aeroplane	Overall length	Fuselage width	Category	Movements
<b>Airbus A380</b>	73.0 m	7.1 m	10	300
<b>Boeing 747-8</b>	76.3 m	6.5 m	10	200
<b>Boeing 747-400</b>	70.7 m	6.5 m	9	300

The longest aeroplanes are categorised by evaluating, based on Table 1 of [AMC2 ADR.OPS.B.010\(a\)\(2\)](#), firstly their overall length and secondly their fuselage width until 700 movements are reached. It may be seen that the number of movements of the longest aeroplanes in the highest category totals only 500. It may also be noted that when evaluating the category appropriate to the overall length of Airbus A380, e.g. category 9, the category selected is actually one level higher as the aeroplane's fuselage width is greater than the maximum fuselage width for category 9. The minimum category for the aerodrome, in this case, is category 9, which is one category level below that of the longest aeroplane.

Aeroplane	Overall length	Fuselage width	Category	Movements
<b>Airbus A321</b>	44.5 m	4.0 m	7	100
<b>Boeing 737-900ER</b>	42.1 m	3.8 m	7	300
<b>ATR 42</b>	22.7 m	2.9 m	4	500

The longest aeroplanes are categorised by evaluating, based on Table 1 of [AMC2 ADR.OPS.B.010\(a\)\(2\)](#), firstly their overall length and secondly their fuselage width until 700 movements are reached. It may be seen that the number of movements of the longest aeroplanes in the highest category totals only 400. The minimum category for the aerodrome is category 6. However, even if there is a relatively wide range of difference between the length of the longest aeroplane (Airbus A321) and the aeroplane for which the 700th movement is reached (ATR 42), the minimum category for the aerodrome may only be downgraded to category 6.

#### Example 4 — Anticipated periods of reduced activity

The level of protection should be no less than that needed for the highest category of aeroplanes planned to use the aerodrome during that period. If the aerodrome has promulgated RFFS category 7, but between 23:00 and 6:00, the largest aeroplane operating has an overall length of 27.5 m and a maximum fuselage width of 3.9 m, the promulgated category may be downgraded to category 5 for that time frame.

#### Example 5 — All-cargo and mail aeroplane operations including dangerous goods

An all-cargo aeroplane is an aeroplane operated for the transportation of cargo including dangerous goods. If an all-cargo aeroplane has an overall length of 47.5 m and a maximum fuselage width of 4.2 m, according to Table 1, category 7 is indicated. As the aeroplane is an all-cargo one, according to Table 2, a reclassification to category 6 may be applied.

## GM6 ADR.OPS.B.010(a)(2) Rescue and firefighting services

*ED Decision 2016/009/R*

### CRITICAL AREA FOR CALCULATING QUANTITIES OF WATER

- (a) The ICAO critical-area concept is applied for rescuing the occupants of an aeroplane. It seeks to control only that area of fire adjacent to the fuselage. The objective is to safeguard the integrity of the fuselage and maintain tolerable conditions for the occupants of the aeroplane. The size of the controlled area required to achieve this for a specific aeroplane has been determined by experimental means.
- (b) There is a need to distinguish between the theoretical critical area, within which it may be necessary to control the fire, and the practical critical area, which is representative of actual aeroplane accident conditions. The theoretical critical area serves only as a means of categorising aeroplanes in terms of the magnitude of the potential fire hazard in which they may become involved. It is not intended to represent the average maximum or minimum spill fire size associated with a particular aeroplane. The theoretical critical area is a rectangle having as one dimension the overall length of the aeroplane and as the other dimension a length which varies with the fuselage's length and width.
- (c) From experiments performed, it has been established that for an aeroplane with a fuselage length equal to or greater than 24 m, in wind conditions of 16–19 km/h and at right angles to the fuselage, the theoretical critical area extends from the fuselage to a distance of 24 m upwind and 6 m downwind. For smaller aeroplanes, a distance of 6 m on either side is adequate. To provide for a progressive increase in the theoretical critical area however, a transition is used when the fuselage length is between 12 and 24 m.
- (d) The overall length of the aeroplane is considered appropriate for the theoretical critical area as the entire length of the aeroplane must be protected from burning. If not, the fire might burn through the skin and enter the fuselage. Moreover, other aeroplanes, such as T-tail ones, often have engines or exit points in their extended portion.
- (e) The formula for the theoretical critical area  $A_T$  should be the following:

Overall length	Theoretical critical area $A_T$
$L < 12$ m	$L \times (12 + W)$
$12 \text{ m} \leq L < 18$ m	$L \times (14 + W)$
$18 \text{ m} \leq L < 24$ m	$L \times (17 + W)$
$L \geq 24$ m	$L \times (30 + W)$

where 'L' is the overall length of the aeroplane, and 'W' is the maximum width of the aeroplane fuselage.

- (f) In practice, it is seldom that the entire theoretical critical area is subject to fire; thus, a smaller area for which it is proposed to have firefighting capacity is referred to as the practical critical area. As a result of a statistical analysis of actual aeroplane accidents, the practical critical area  $A_P$  has been found to be approximately two thirds of the theoretical critical area  $A_T$ , or

$$A_p = 0.667 \times A_T$$

- (g) The quantity of water for foam production should be calculated with the following formula:

$$Q = Q_1 + Q_2$$

where:

- ‘Q’ is the total water required;
- ‘Q<sub>1</sub>’ is the water used to control the fire in the practical critical area; and
- ‘Q<sub>2</sub>’ is the water required after control of the fire has been established, and is needed for maintaining this control and/or extinguishing the remaining fire.

(h) The water required for control of the fire in the practical critical area (Q<sub>1</sub>) may be expressed by the following formula:

$$Q_1 = A_p \times R \times T$$

where:

- ‘A<sub>p</sub>’ is the practical critical area;
- ‘R’ is the rate of application; and
- ‘T’ is the time of application.

(i) The amount of water required for Q<sub>2</sub> may not be exactly calculated as it depends on a number of variables. The factors considered to be of primary importance are:

- (1) the maximum gross mass of the aeroplane;
- (2) the maximum passenger capacity of the aeroplane;
- (3) the maximum fuel load of the aeroplane; and
- (4) previous experience (analysis of aeroplane RFF operations).

These factors, when plotted on a graph, are used to calculate the total amount of water required for each airport category. The volume of water for Q<sub>2</sub>, as a percentage of Q<sub>1</sub>, varies from about 0 % for category 1 aerodromes to about 190 % for a category 10 aerodrome.

(j) The relation between Q<sub>1</sub> and Q<sub>2</sub> for aeroplanes representative of each airport category is shown in the following table:

Aerodrome category	Q <sub>2</sub> = percentage of Q <sub>1</sub>
1	0 %
2	27 %
3	30 %
4	58 %
5	75 %
6	100 %
7	129 %
8	152 %
9	170 %
10	190 %

## AMC1 ADR.OPS.B.010(a)(4) Rescue and firefighting services

*ED Decision 2014/012/R*

### MEDICAL STANDARDS FOR RFFS PERSONNEL

The aerodrome operator should ensure that appropriate medical standards are met by RFFS personnel.

## GM1 ADR.OPS.B.010(a)(4) Rescue and firefighting services

ED Decision 2020/009/R

### MEDICAL ASSESSMENT

#### 1. General

Rescue and firefighting personnel, when responding to an accident, need to be capable of withstanding physically aggressive conditions whilst performing efficiently. Additionally, managing life-threatening situations which put at risk aircraft occupants' safety requires also mental fitness. For this reason, decision-making and stress management should not be impaired.

The key fitness components for rescue and firefighting personnel are aerobic fitness, anaerobic fitness, flexibility and medical fitness. Optimum physical and medical fitness would mean that a firefighter is able to carry out rescue and firefighting activities safely, successfully and without unjustified fatigue.

In order to understand better the key fitness components, the following aspects may have to be considered:

**Aerobic fitness** refers to the ability to continue to exercise for prolonged periods of time at low to moderate or high intensity. This depends upon the capacity of the body's heart, lungs and blood to get the oxygen to the muscles (VO<sub>2</sub>) providing the sustained energy to maintain prolonged exercise.

**Anaerobic fitness** works differently to aerobic fitness. It is an activity that requires high levels of strength and is done for only a very short period of time at a high level of intensity. Anaerobic fitness may be defined as higher levels of muscular strength, speed and power.

**Flexibility** refers to the ability to move the limbs and joints into specific positions at the extreme of their normal range of movement. Flexibility is important as it will allow the body to work in cramped positions without unduly stressing the muscles, tendons and ligaments and may reduce the risk of injury.

#### 2. Definitions

For the purpose of this guidance, the following definitions can be considered:

'Assessment' refers to the conclusion on the medical fitness of a person based on the evaluation of the applicant's medical history, medical examinations and medical tests which are performed.

'Medical staff' refers to general medical practitioners (GMPs) and occupational health medical practitioners (OHMPs) who have appropriate qualifications and/or experience in the field of occupational medicine practice or aeromedical examiners (AMEs) or aeromedical centres (AeMCs).

'Significant' refers to a degree of a medical condition, the effect of which would prevent the safe performance of duties related to rescue and firefighting.

#### 3. Medical confidentiality

All persons involved in medical examinations and assessments ensure that medical confidentiality is respected at all times. For this reason, all reports and records are to be securely held with accessibility restricted only to authorised personnel.

#### 4. Decrease in medical fitness

Rescue and firefighting personnel need to exercise a duty of care and not to perform their duties when they are aware of any decrease in their medical fitness, to the extent that this condition might render

them unable to perform their duties. Furthermore, without undue delay, medical advice is needed when they:

- (a) have undergone a surgical operation or invasive procedure;
- (b) have commenced the regular use of any medication;
- (c) have suffered any significant personal injury;
- (d) have been suffering from any significant illness;
- (e) are pregnant; and
- (f) have been admitted to hospital or medical clinic.

In these cases, the medical fitness of the person is assessed by medical staff in order to decide whether the person is fit to resume duties. Additionally, following recovery from significant illness or injury, it may be necessary, after recommendation of the medical staff, to undergo any relevant physical fitness tests prior to a return to operational duty.

#### **5. Medical staff**

- (a) Medical examinations and/or assessments are conducted by medical staff who have knowledge of the rescue and firefighting personnel's workloads and risk factors.
- (b) When conducting medical examinations and/or assessments, the medical staff member:
  - (1) ensures that communication with the person can be established without language barriers; and
  - (2) makes the person aware of the consequences of providing incomplete, inaccurate or false statements on their medical history.
- (c) After completion of the medical examinations and/or assessments, the medical staff member:
  - (1) advises the person whether they have been assessed as fit or unfit;
  - (2) informs the person of any limitation(s) to operational duty;
  - (3) completes a medical report;
  - (4) informs the person of their responsibilities in the case of decrease in medical fitness; and
  - (5) if the person has been assessed as unfit, informs them of their right of a secondary review.

#### **6. Medical assessment programme**

A medical assessment programme is a tool to promote and facilitate that rescue and firefighting personnel are free of any physical or mental illness, which might lead to incapacitation or inability to perform their assigned duties and responsibilities.

The programme includes an initial assessment prior to employment and re-examinations at regular intervals. The frequency of the re-examinations may take into account the age of the person, the medical history, etc.

#### **7. Medical assessment**

- (a) The objective of a medical assessment is to assess the physical and mental ability of the rescue and firefighting personnel to:

- (1) undergo the training which is necessary to acquire and maintain competence in the execution of their tasks related to rescue and firefighting, such as working in a high-temperature environment, using protective breathing equipment in a simulated smoke-filled environment, assisting trapped or injured passengers to escape the aircraft, etc.; and
  - (2) perform their duties in psychologically demanding circumstances.
- (b) Fit rescue and firefighting personnel will be free from any:
- (1) abnormality, congenital or acquired;
  - (2) active, latent, acute or chronic disease or disability;
  - (3) wound, injury or sequel from an operation;
  - (4) effect or side effect of any prescribed or non-prescribed therapeutic, diagnostic or preventive medication taken, which entails a degree of functional incapacity that is likely to interfere with the performance of their duties or could render them likely to become suddenly unable to perform their duties.
- (c) The initial medical assessment includes at least:
- (1) an assessment of the medical history; and
  - (2) a clinical examination of the following:
    - (i) cardiovascular system;
    - (ii) respiratory system;
    - (iii) musculoskeletal system;
    - (iv) otorhinolaryngology (ENT); and
    - (v) visual system.
- (d) Each subsequent medical assessment includes:
- (1) an assessment of the medical history; and
  - (2) a clinical examination (if deemed necessary) in accordance with best medical practices.

Nevertheless, if during any medical assessment there is a doubt or if clinically indicated, additional medical examinations, tests or investigations may also be conducted if considered necessary by the medical staff.

#### CLINICAL EXAMINATION AND INVESTIGATION

Clinical examination may include the following:

- (a) Cardiovascular system
  - (1) blood pressure measurement; and
  - (2) a standard 12-lead resting ECG and report. An extended cardiovascular assessment (including an exercise ECG) is required when clinically indicated.
- (b) Respiratory system
  - (1) pulmonary function tests; and
  - (2) chest X-ray on clinical indication.

- (c) Musculoskeletal system
- (d) ENT
  - (1) a routine inspection of ears, nose and throat;
  - (2) a conversational hearing test during which the person is able to understand correctly conversational speech when tested with each ear at a distance of 2 metres from and with their back turned towards the medical staff; and
  - (3) on clinical indication, pure tone audiometry measured at 500, 1 000, 2 000, 3 000, and 4 000 Hz.
- (e) Visual system using standard techniques
  - (1) distance vision;
  - (2) near vision;
  - (3) visual fields, on clinical indication;
  - (4) colour vision (initial only or on clinical indication);
  - (5) eye movements; and
  - (6) ocular inspection.
- (f) Urine tests for blood, protein and sugar
- (g) Blood tests

Persons will undergo a blood test, taking into account the medical history and following the physical examination of:

  - (1) full blood count;
  - (2) liver function;
  - (3) kidney function;
  - (4) blood sugar; and
  - (5) serum lipids, including cholesterol.

## **8. Medical report**

After the completion of each medical assessment, a written medical report will be provided by the medical staff to the person concerned, as well as to the organisation employing them.

The report indicates the date of the medical assessment, whether the person has been assessed as fit or unfit, the date of the next medical assessment and, if applicable, any limitation(s). All other elements are subject to medical confidentiality; therefore, they are not included in the report.

## **9. Limitations**

If any person does not fully satisfy the established medical criteria, they may be allowed to exercise their tasks with some limitations. The limitations will be detailed by the medical staff and listed in the medical report.

Removal of the limitations is normally taking place following a re-assessment by the medical staff.



## EXAMPLES OF LIMITATIONS

Depending on the case, operational limitations and/or use of aids may be imposed, as follows (list not exhaustive and based on the fit assessment and operational requirements):

- (a) Wearing of corrective lenses;
- (b) Wearing of hearing aids;
- (c) Reduction of the interval between consecutive medical examinations or assessments. In this case, the persons concerned will present themselves for re-examination when advised and follow any medical recommendations;
- (d) Operational restrictions such as:
  - (1) use of breathing apparatus;
  - (2) work in confined spaces;
  - (3) ladder climbing;
  - (4) working at heights;
  - (5) driving;
  - (6) operating or carrying heavy equipment; and
  - (7) descending the pole; and
- (e) Working only in specific periods of the day (e.g. day shifts only).

## GM2 ADR.OPS.B.010(a)(4) Rescue and firefighting services

*ED Decision 2020/009/R*

### MEDICAL CRITERIA FOR RFSS PERSONNEL

#### 1. **CARDIOVASCULAR SYSTEM**

- (a) General
  - (1) Rescue and firefighting personnel with any of the following conditions are assessed as unfit:
    - (i) aneurysm of the thoracic or supra-renal abdominal aorta, before or after a surgery;
    - (ii) significant functional abnormality of any of the heart valves;
    - (iii) heart or heart/lung transplantation;
    - (iv) symptomatic sinoatrial disease;
    - (v) complete atrioventricular block;
    - (vi) a sub-endocardial pacemaker;
    - (vii) symptomatic channelopathies including QT prolongation and Brugada syndrome;
    - (viii) an automatic implantable defibrillating system;
    - (ix) a ventricular anti-tachycardia pacemaker; and
    - (x) pulmonary hypertension.

- 
- (2) Rescue and firefighting personnel with a suspected or established diagnosis of any of the following conditions are assessed as unfit. Following satisfactory treatment and specialist review, a fit assessment can be considered.
- (i) Coronary arterial disease before or after intervention;
  - (ii) Peripheral arterial disease before or after a surgery;
  - (iii) Aneurysm of the infra-renal abdominal aorta, before or after a surgery;
  - (iv) Functionally insignificant cardiac valvular abnormalities;
  - (v) After a cardiac valve surgery;
  - (vi) Significant disorder of cardiac rhythm, including pacemakers and ablation therapy;
  - (vii) Abnormality of the pericardium, myocardium or endocardium;
  - (viii) Congenital abnormality of the heart, before or after a corrective surgery;
  - (ix) Recurrent vasovagal syncope;
  - (x) Arterial or venous thrombosis;
  - (xi) Pulmonary embolism; and
  - (xii) Cardiovascular condition that requires systemic anticoagulant therapy.
- (b) Peripheral arterial disease
- Rescue and firefighting personnel with peripheral arterial disease, before or after a surgery, undergo a satisfactory cardiological evaluation including an exercise ECG. Further tests may be required which should show no evidence of myocardial ischaemia or significant coronary artery stenosis. A fit assessment may be considered provided that:
- (1) a Doppler echocardiography of the affected area is satisfactory; and
  - (2) there is no sign of significant coronary artery disease or evidence of significant atheroma elsewhere, and no functional impairment of the end organ supplied.
- (c) Aortic aneurysm
- Rescue and firefighting personnel:
- (1) with an aneurysm of the infra-renal abdominal aorta are assessed as unfit;
  - (2) may be assessed as fit after a surgery for an infra-renal aortic aneurysm without complications and subject to being free of disease of the carotid and coronary circulation.
- (d) Cardiac valvular abnormalities
- Rescue and firefighting personnel:
- (1) with previously unrecognised cardiac murmurs will undergo a cardiological evaluation. If considered significant, further investigation may be required subject to the recommendation of the cardiologist;
  - (2) with minor cardiac valvular abnormalities may be assessed as fit. Regular cardiological follow-up, including at least a 2D Doppler echocardiography, as determined by the cardiologist is required;
  - (3) with significant abnormality of any of the heart valves are assessed as unfit.

- 
- (4) with bicuspid aortic valve may be assessed as fit if no other cardiac or aortic abnormality is demonstrated and if their effort capacity is not adversely affected. Regular cardiological follow-up, including a 2D Doppler echocardiography, is required;
  - (5) with mild aortic stenosis may be assessed as fit if their effort capacity is not adversely affected. Annual cardiological follow-up is required which includes a 2D Doppler echocardiography;
  - (6) with aortic regurgitation may be assessed as fit only if regurgitation is minor and there is no evidence of volume overload. There will be no demonstrable abnormality of the ascending aorta on a 2D Doppler echocardiography. Cardiological follow-up including a 2D Doppler echocardiography is required;
  - (7) with rheumatic mitral stenosis may only be assessed as fit in favourable cases after a cardiological evaluation including a 2D Doppler echocardiography;
  - (8) with uncomplicated minor mitral valve regurgitation may be assessed as fit if their effort capacity is not adversely affected. Regular cardiological follow-up including a 2D Doppler echocardiography is required;
  - (9) with mitral valve prolapse and mild mitral regurgitation may be assessed as fit if their effort capacity is not adversely affected;
  - (10) with evidence of volume overloading of the left ventricle demonstrated by increased left ventricular end-diastolic diameter are assessed as unfit;
  - (11) with cardiac valve replacement/repair are assessed as unfit. After a satisfactory cardiological evaluation, a fit assessment may be considered; and
  - (12) after a valvular surgery without any symptom may be assessed as fit after 6 months subject to:
    - (i) normal valvular and ventricular function as judged by a 2D Doppler echocardiography;
    - (ii) satisfactory symptom-limited exercise ECG or equivalent;
    - (iii) demonstrated absence of coronary artery disease unless this has been satisfactorily treated by re-vascularisation;
    - (iv) no cardioactive medication being required;
    - (v) annual cardiological follow-up to include an exercise ECG and a 2D Doppler echocardiography. Longer periods may be acceptable once a stable condition has been confirmed by cardiological evaluations; and
  - (13) with implanted mechanical valves are assessed as unfit. Persons with implanted biological valves may be assessed as fit subject to documented exemplary compliance with their anti-platelet therapy. Age factors are part of the risk assessment.
- (e) Thromboembolic disorders

Rescue and firefighting personnel with arterial or venous thrombosis or pulmonary embolism are assessed as unfit during anticoagulation. Rescue and firefighting personnel with pulmonary embolism will also be evaluated by a cardiologist. Following cessation of anticoagulant therapy, for any indication, they need to undergo a re-assessment before returning to duty.

(f) Other cardiac disorders

Rescue and firefighting personnel:

- (1) with an abnormality of the pericardium, myocardium or endocardium are assessed as unfit. A fit assessment may be considered following a complete resolution and a satisfactory cardiological evaluation which may include a 2D Doppler echocardiography, an exercise ECG, a 24-hour ambulatory ECG, and/or a myocardial perfusion scan or an equivalent test. Coronary angiography or an equivalent test may be indicated. Regular cardiological follow-up may be required; and
- (2) with a congenital abnormality of the heart, including those who have undergone surgical correction, are assessed as unfit. Rescue and firefighting personnel with minor abnormalities that are functionally relevant and do not adversely affect their effort capacity may be assessed as fit following a cardiological assessment. No cardioactive medication is acceptable. Investigations may include a 2D Doppler echocardiography, an exercise ECG and a 24-hour ambulatory ECG. Regular cardiological follow-up may be required.

(g) Syncope

- (1) Rescue and firefighting personnel with a history of recurrent episodes of syncope are assessed as unfit. A fit assessment may be considered after a sufficient period of time without recurrence provided that a cardiological evaluation is satisfactory.
- (2) A cardiological evaluation following a single episode of syncope includes at least:
  - (i) a satisfactory symptom-limited exercise ECG. If the exercise ECG is abnormal, a myocardial perfusion scan or an equivalent test is required;
  - (ii) a 2D Doppler echocardiogram showing neither significant selective chamber enlargement nor structural or functional abnormality of the heart, valves or myocardium;
  - (iii) a 24-hour ambulatory ECG recording showing no conduction disturbance, complex or sustained rhythm disturbance or evidence of myocardial ischaemia; and
  - (iv) a tilt test carried out to a standard protocol showing no evidence of vasomotor instability.
- (3) Neurological review may be required.

(h) Blood pressure

- (1) Blood pressure will be within normal limits.
- (2) Rescue and firefighting personnel:
  - (i) with symptomatic hypotension; or
  - (ii) whose blood pressure at examination consistently exceeds 140 mmHg systolic and/or 90 mmHg diastolic, with or without treatment; or
  - (iii) who have initiated a medication for the control of blood pressure,will require a period of suspension from the duties in order to assess the severity of the condition, impose or change the treatment and/or to establish the absence of significant side effects.

- 
- (3) The investigation of possible hypertension and confirmation of adequate control on medication includes a 24-hour blood pressure monitoring.
  - (4) Anti-hypertensive medication may include:
    - (i) non-loop diuretic agents;
    - (ii) angiotensin converting enzyme (ACE) inhibitors;
    - (iii) angiotensin II receptor blocking agents;
    - (iv) long-acting slow channel calcium blocking agents; and
    - (v) certain (generally hydrophilic) beta-blocking agents.
  - (5) Following initiation of medication for the control of blood pressure, rescue and firefighting personnel are re-assessed to verify that the treatment is compatible with the safe exercise of their duties.
    - (i) Coronary artery disease
      - (1) Rescue and firefighting personnel with chest pain will undergo a full investigation before a fit assessment may be considered. Rescue and firefighting personnel with angina pectoris are assessed as unfit, whether or not it is abolished by medication.
      - (2) Rescue and firefighting personnel with suspected asymptomatic coronary artery disease undergo a cardiological evaluation including an exercise ECG. Further tests (myocardial perfusion scanning, stress echocardiography, coronary angiography or equivalent) may be required, which should show no evidence of myocardial ischaemia or significant coronary artery stenosis.
      - (3) After an ischaemic cardiac event, including revascularisation (PTCI/stent and CABG), rescue and firefighting personnel without symptoms need to have reduced any vascular risk factors to an appropriate level. Medication, when used to control cardiac symptoms, is not acceptable. All rescue and firefighting personnel will be on acceptable secondary prevention treatment.
        - (i) A coronary angiogram or equivalent obtained around the time of, or during, the ischaemic myocardial event, and a complete, detailed clinical report of the ischaemic event and of any operative procedures is available.
          - (A) There is no stenosis more than 50 % in any major untreated vessel, in any vein or artery graft or at the site of an angioplasty/stent, except in a vessel subtending a myocardial infarction. More than two stenoses between 30 % and 50 % within the vascular tree are not acceptable.
          - (B) The whole coronary vascular tree is assessed as satisfactory by a cardiologist, and particular attention is paid to multiple stenoses and/or multiple revascularisations.
          - (C) An untreated stenosis greater than 30 % in the left main or proximal left anterior descending coronary artery is not acceptable.
        - (ii) At least 6 months from the ischaemic myocardial event, including revascularisation, the following investigations need to be completed:
          - (A) an exercise ECG showing neither evidence of myocardial ischaemia nor rhythm or conduction disturbance;

- (B) an echocardiogram or an equivalent test showing satisfactory left ventricular function with no important abnormality of wall motion (such as dyskinesia or akinesia) and a left ventricular ejection fraction of 50 % or more;
  - (C) in cases of angioplasty/stenting, a myocardial perfusion scan or equivalent test, which shows no evidence of reversible myocardial ischaemia. If there is any doubt about myocardial perfusion, in other cases (infarction or bypass grafting), a perfusion scan is also required; and
  - (D) further investigations, such as a 24-hour ECG, may be necessary to assess the risk of any significant rhythm disturbance.
- (iii) Follow-up is conducted annually (or more frequently, if necessary) to ensure that there is no deterioration of the cardiovascular status. It includes a cardiological evaluation, an exercise ECG and a cardiovascular risk assessment. Additional investigations may be required.
- (iv) After coronary artery vein bypass grafting, a myocardial perfusion scan or an equivalent test is performed on clinical indication, and in all cases within 5 years from the procedure.
- (v) In all cases, coronary angiography, or an equivalent test, is considered at any time if symptoms, signs or non-invasive tests indicate myocardial ischaemia.
- (vi) Rescue and firefighting personnel may be assessed as fit to undergo the physical fitness tests after successful completion of the 6-month or later review.
- (j) Rhythm and conduction disturbances
- (1) Rescue and firefighting personnel with any significant rhythm or conduction disturbance may be assessed as fit after a cardiological evaluation and with appropriate follow-up. Such an evaluation includes:
- (i) an exercise ECG to show no significant abnormality of rhythm or conduction, and no evidence of myocardial ischaemia. Withdrawal of cardioactive medication prior to the test is required;
  - (ii) a 24-hour ambulatory ECG to demonstrate no significant rhythm or conduction disturbance; and
  - (iii) a 2D Doppler echocardiogram to show no significant selective chamber enlargement or significant structural or functional abnormality, and a left ventricular ejection fraction of at least 50 %.
- Further evaluation may include:
- (iv) 24-hour ECG recording repeated as necessary;
  - (v) electrophysiological study (EPS);
  - (vi) myocardial perfusion imaging or equivalent test;
  - (vii) cardiac magnetic resonance imaging (MRI) or equivalent test; and
  - (viii) coronary angiogram or equivalent test.

- (2) Rescue and firefighting personnel with supraventricular or ventricular ectopic complexes on a resting ECG may require no further evaluation, provided that the frequency can be shown to be no greater than one per minute; for example, on an extended ECG strip.

Rescue and firefighting personnel with asymptomatic isolated uniform ventricular ectopic complexes may be assessed as fit but frequent or complex forms require a full cardiological evaluation.

- (3) Ablation
- (i) Rescue and firefighting personnel who have undergone ablation therapy are assessed as unfit for a minimum period of 2 months.
  - (ii) A fit assessment may be considered following successful catheter ablation provided that an EPS demonstrates satisfactory control has been achieved.
  - (iii) Where EPS is not performed, longer periods of unfitness and cardiological follow-up needs to be considered.
  - (iv) Follow-up includes a cardiological assessment.

- (4) Supraventricular arrhythmias

Rescue and firefighting personnel with significant disturbance of supraventricular rhythm, including sinoatrial dysfunction, whether intermittent or established, are assessed as unfit. A fit assessment may be considered if a cardiological evaluation, including the prospective risk of stroke, is satisfactory. Anticoagulation therapy is disqualifying.

- (i) For pre-employment assessments, for rescue and firefighting personnel with atrial fibrillation/flutter, a fit assessment is limited to those with a single episode of arrhythmia which is considered to be unlikely to recur.
- (ii) Rescue and firefighting personnel with asymptomatic sinus pauses up to 2.5 seconds on a resting ECG may be assessed as fit following a satisfactory cardiological evaluation. The cardiological evaluation includes at least the following: an exercise ECG, a 2D Doppler echocardiography and a 24-hour ambulatory ECG.
- (iii) Rescue and firefighting personnel with symptomatic sino-atrial disease are assessed as unfit.

- (5) Mobitz type 2 atrio-ventricular block

Rescue and firefighting personnel with Mobitz type 2 AV block may be assessed as fit after a full cardiological evaluation confirms the absence of distal conducting tissue disease.

- (6) Complete right bundle branch block

Rescue and firefighting personnel with complete right bundle branch block undergo a cardiological evaluation on first presentation.

- (7) Complete left bundle branch block

A fit assessment may be considered, as follows:

- (i) At first assessment, rescue and firefighting personnel may be assessed as fit after a full cardiological evaluation showing no pathology. Depending on the clinical situation, a period of stability may be required.
  - (ii) Rescue and firefighting personnel, during a periodic assessment of their medical fitness with a de-novo left bundle branch block may be assessed as fit after a cardiological evaluation showing no pathology. A period of stability may be required.
  - (iii) A cardiological evaluation is recommended after 12 months in all cases.
- (8) Ventricular pre-excitation
- Rescue and firefighting personnel with pre-excitation may be assessed as fit if they are asymptomatic, and an electrophysiological study, including an adequate drug-induced autonomic stimulation protocol, reveals no inducible re-entry tachycardia and the existence of multiple pathways is excluded. Cardiological follow-up will be required including a 24-hour ambulatory ECG recording showing no tendency to symptomatic or asymptomatic tachy-arrhythmia.
- (9) QT prolongation
- Rescue and firefighting personnel with QT prolongation need to have a cardiological evaluation. A fit assessment may be considered in asymptomatic persons.

## **2. RESPIRATORY SYSTEM**

- (a) Rescue and firefighting personnel with significant impairment of pulmonary function are assessed as unfit. A fit assessment could be considered once pulmonary function has recovered and is satisfactory.
  - (b) Rescue and firefighting personnel with any sequelae of disease or surgical intervention in any part of the respiratory tract likely to cause incapacitation, are assessed as unfit. A fit assessment could be considered after a specialist evaluation.
  - (c) Following significant respiratory illness, physical fitness tests will be performed prior to a return to operational duty.
  - (d) Examination
    - (1) A spirometry is required for initial examination. An FEV1/FVC ratio less than 75 % requires an evaluation by a specialist in respiratory disease before a fit assessment can be considered.
    - (2) Posterior/anterior chest radiography may be required at initial, revalidation or renewal examinations when indicated on clinical or epidemiological grounds.
  - (e) Chronic obstructive airways disease
- Rescue and firefighting personnel with chronic obstructive airways disease are assessed as unfit. Rescue and firefighting personnel with only minor impairment of their pulmonary function may be assessed as fit after a specialist respiratory evaluation. Limitation of duties may be required. Rescue and firefighting personnel with pulmonary emphysema may be assessed as fit for limited duties excluding use of breathing apparatus following a specialist evaluation showing that the condition is stable and not causing significant symptoms.



(f) Asthma

Rescue and firefighting personnel with asthma that requires medication may be assessed as fit if the asthma is considered stable with satisfactory pulmonary function tests and medication is compatible with the safe execution of the duties. Operational limitations may be appropriate.

(g) Inflammatory disease

(1) For rescue and firefighting personnel with active inflammatory disease of the respiratory system, a fit assessment may be considered following a specialist evaluation when the condition has resolved without sequelae and no medication is required.

(2) Rescue and firefighting personnel with chronic inflammatory diseases may be assessed as fit following a specialist evaluation that shows mild disease with no risk of acute worsening with acceptable pulmonary function test, including bronchial challenge test, and medication compatible with the safe execution of duties. Operational limitations may be required.

(h) Sarcoidosis

(1) Rescue and firefighting personnel with active sarcoidosis are assessed as unfit. A specialist evaluation is undertaken with respect to the possibility of systemic, particularly cardiac, involvement. A fit assessment may be considered if minimal medication is required, and the disease is limited to hilar lymphadenopathy and inactive.

(2) Rescue and firefighting personnel with cardiac or neurological sarcoid are assessed as unfit.

(i) Pneumothorax

Rescue and firefighting personnel with a spontaneous pneumothorax are assessed as unfit. A fit assessment may be considered:

(1) 6 weeks after the event provided full recovery from a single event has been confirmed in a full respiratory evaluation including a CT scan or equivalent; and

(2) following surgical intervention in the case of a recurrent pneumothorax provided that there is satisfactory recovery.

(j) Thoracic surgery

(1) Rescue and firefighting personnel that require a thoracic surgery are assessed as unfit until such time as the effects of the operation are no longer likely to interfere with the safe exercise of their duties.

(2) A fit assessment may only be considered after satisfactory recovery and a full respiratory evaluation including a CT scan or equivalent. The underlying pathology which necessitated the surgery is considered in the assessment process.

(k) Sleep apnoea syndrome/sleep disorder

(1) Rescue and firefighting personnel with unsatisfactorily treated sleep apnoea syndrome and suffering from excessive daytime sleepiness are assessed as unfit.

(2) Rescue and firefighting personnel with obstructive sleep apnoea undergo a cardiological and pneumological evaluation.

- (3) A fit assessment may be considered subject to the extent of symptoms, and satisfactory treatment.

### **3. DIGESTIVE SYSTEM**

- (a) Rescue and firefighting personnel with any sequelae of disease or surgical intervention in any part of the digestive tract or its adnexa likely to cause incapacitation, are assessed as unfit. A fit assessment may be considered after a specialist evaluation.

- (b) Oesophageal varices

Rescue and firefighting personnel with oesophageal varices are assessed as unfit.

- (c) Pancreatitis

- (1) Rescue and firefighting personnel with pancreatitis are assessed as unfit pending an assessment. A fit assessment may be considered if the cause (e.g. gallstone, other obstruction, medication) is removed.

- (2) Alcohol may be a cause of dyspepsia and pancreatitis. A full evaluation of its use/abuse is required.

- (d) Gallstones

Rescue and firefighting personnel:

- (1) with a single large gallstone may be assessed as fit after an evaluation;

- (2) with multiple gallstones may be assessed as fit while awaiting assessment or treatment provided that the symptoms are unlikely to interfere with duties.

- (e) Inflammatory bowel disease

Rescue and firefighting personnel with an established diagnosis or history of chronic inflammatory bowel disease may be assessed as fit if the disease is in established stable remission, and only minimal, if any, medication is being taken. Regular follow-up is required.

- (f) Hernia

Rescue and firefighting personnel will be free of hernia. A fit assessment may be considered subject to the extent of symptoms, satisfactory treatment and after a specialist evaluation. The risk of secondary complications or worsening should be minimal and the rescue and firefighter will be subject to regular follow-up.

- (g) Dyspepsia

Rescue and firefighting personnel with recurrent dyspepsia that requires medication needs to be investigated by internal examination including radiologic or endoscopic examination. Laboratory testing includes a haemoglobin assessment. Any demonstrated ulceration or significant inflammation requires evidence of recovery before a fit assessment may be considered.

- (h) Abdominal surgery

Rescue and firefighting personnel who have undergone a surgical operation on the digestive tract or its adnexa, including a total or partial excision or a diversion of any of these organs, are assessed as unfit. A fit assessment may be considered after full recovery, the applicant is asymptomatic, and the risk of secondary complications or recurrence is minimal.

---

**4. METABOLIC AND ENDOCRINE SYSTEMS**

- (a) Rescue and firefighting personnel with metabolic, nutritional or endocrine dysfunction may be assessed as fit if the condition is asymptomatic, clinically compensated and stable with or without replacement therapy, and regularly reviewed by an appropriate specialist.
- (b) Obesity
- (1) Obese rescue and firefighting personnel (e.g. with a body mass index (BMI)  $\geq 35$ ) may be assessed as fit only if the excess weight is not likely to interfere with the safe exercise of duties. A cardiovascular risk factor review and a pneumological examination by a specialist needs to be considered. The presence of sleep apnoea syndrome needs to be ruled out.
  - (2) Functional testing in the working environment may be necessary before a fit assessment may be considered.
- (c) Thyroid dysfunction
- Rescue and firefighting personnel with hyperthyroidism or hypothyroidism attain a stable euthyroid state before a fit assessment may be considered. Follow-up includes periodic thyroid function blood tests.
- (d) Abnormal glucose metabolism
- Glycosuria and abnormal blood glucose levels needs to be investigated. A fit assessment may be considered if normal glucose tolerance is demonstrated (low renal threshold) or impaired glucose tolerance without diabetic pathology is fully controlled by diet and regularly reviewed.
- (e) Diabetes mellitus
- Subject to an at least annual specialist endocrinological assessment, absence of complications likely to interfere with performance of duties, evidence of control of blood sugar with no significant hypoglycaemic episodes, rescue and firefighting personnel with diabetes mellitus:
- (1) that do not require medication or require non-hypoglycaemic antidiabetic medications may be assessed as fit;
  - (2) that require the use of potentially hypoglycaemic medication(s) including sulphonyl ureas and insulin, may be assessed as fit with an operational limitation (or limitations), including documented testing whilst performing duties. For rescue and firefighting personnel treated with insulin, a review to include the results of operational blood sugar testing will be undertaken every 6 months;
  - (3) other cardiovascular risk factors including cholesterol will require cardiovascular risk factor management. An exercise ECG will be performed when diagnosed, every 5 years under 40 years of age, and annually thereafter;
  - (4) undergo HbA1c measurement every 3 months, with the exception of the rescue and firefighting personnel that do not require sulphonyl urea or insulin treatment where an extension of the testing to 6 months is acceptable; and
  - (5) require annual follow-up by a specialist including demonstrating the absence of diabetic complications such as neuropathy, retinopathy, arteriopathy or nephropathy.

---

**5. HAEMATOLOGY**

- (a) Rescue and firefighting personnel with any significant haematological condition are assessed as unfit. Following a specialist evaluation, a fit assessment can be considered.
- (b) Anaemia
- (1) Anaemia demonstrated by a reduced haemoglobin level needs to be investigated. A fit assessment may be considered in cases where the primary cause has been treated (e.g. iron or B12 deficiency) and the haemoglobin or haematocrit has stabilised at a satisfactory level, for the required duties.
  - (2) Anaemia which is unamenable to treatment is disqualifying.
- (c) Haemoglobinopathy and red cell enzyme defects
- Rescue and firefighting personnel with a haemoglobinopathy and red cell enzyme defects are assessed as unfit. A fit assessment may be considered where minor thalassaemia, sickle cell disease or other conditions are diagnosed without a history of crises and where full functional capability is demonstrated.
- (d) Coagulation disorders
- (1) Rescue and firefighting personnel with significant coagulation disorders are assessed as unfit. A fit assessment may be considered if there is no history of significant bleeding or clotting episodes and the haematological data indicates that there is no interference with the safe performance of duties.
  - (2) Rescue and firefighting personnel that require anticoagulants are assessed as unfit.
- (e) Disorders of the lymphatic system
- Lymphatic enlargement requires investigation. A fit assessment may be considered in cases of an acute infectious process which is fully recovered, or Hodgkin's lymphoma, or other lymphoid malignancy which has been treated and is in full remission. Regular follow-up needs to be performed.
- (f) Leukaemia
- (1) Rescue and firefighting personnel with acute leukaemia are assessed as unfit. Once in established remission, applicants may be assessed as fit.
  - (2) Rescue and firefighting personnel with chronic leukaemia are assessed as unfit. A fit assessment may be considered after remission and a period of demonstrated stability.
  - (3) Rescue and firefighting personnel with a history of leukaemia will have no history of central nervous system involvement and no continuing side effects from treatment likely to interfere with the safe performance of duties. Haemoglobin and platelet levels need to be satisfactory.
  - (4) Regular follow-up is recommended in all cases of leukaemia.
- (g) Splenomegaly
- Splenomegaly needs to be investigated. A fit assessment may be considered if the enlargement is minimal, stable and no associated pathology is demonstrated, or if the enlargement is minimal and associated with another acceptable condition.

(h) Splenectomy

Following splenectomy, a fit assessment may be considered if there is full recovery and the platelet level is acceptable.

**6. GENITOURINARY SYSTEM**

(a) The urine will not contain any abnormal element considered to be of pathological significance.

(b) Rescue and firefighting personnel with any sequelae of disease or surgical procedures on the genitourinary system or its adnexa likely to cause incapacitation, in particular any obstruction due to stricture or compression, are assessed as unfit. A fit assessment may be considered following a specialist evaluation.

(c) Abnormal urinalysis

Any abnormal finding including proteinuria, haematuria and glycosuria on urinalysis needs to be investigated.

(d) Renal disease

(1) Rescue and firefighting personnel presenting with any signs of renal disease are assessed as unfit. A fit assessment may be considered if blood pressure is satisfactory and renal function is acceptable and there are no significant lesions.

(2) Rescue and firefighting personnel that require dialysis are assessed as unfit.

(e) Urinary calculi

(1) Rescue and firefighting personnel with an asymptomatic calculus or a history of renal colic need to be investigated. A fit assessment may be considered after successful treatment for a calculus and with appropriate follow-up.

(2) Residual calculi are disqualifying unless they are in a location where they are unlikely to move and give rise to symptoms.

(f) Renal and urological surgery

(1) Rescue and firefighting personnel who have undergone a major surgical operation on the genitourinary system or its adnexa involving a total or partial excision or a diversion of any of its organs are assessed as unfit until recovery is complete, the person is asymptomatic and the risk of secondary complications is minimal.

(2) Rescue and firefighting personnel with compensated nephrectomy without hypertension or uraemia may be assessed as fit.

(3) Rescue and firefighting personnel who have undergone renal transplantation may be considered for a fit assessment after full recovery with evidence that it is fully compensated and tolerated with only minimal immuno-suppressive therapy. Limitation(s) to duties will be considered.

(4) Rescue and firefighting personnel who have undergone total cystectomy may be considered for a fit assessment if there is satisfactory urinary function, no infection and no recurrence of primary pathology.

**7. INFECTIOUS DISEASES**

(a) Rescue and firefighting personnel diagnosed with or presenting symptoms of an infectious disease will undergo specialist evaluation and may be considered fit when they are

asymptomatic and providing that the therapy does not compromise the safe performance of their duties.

- (b) In cases of an infectious disease, consideration is given to a history of, or clinical signs indicating, underlying impairment of the immune system.
- (c) Tuberculosis
  - (1) Rescue and firefighting personnel with active tuberculosis are assessed as unfit. A fit assessment may be considered following completion of therapy.
  - (2) Rescue and firefighting personnel with quiescent or healed lesions may be assessed as fit. A specialist evaluation needs to consider the extent of the disease, the treatment required and possible side effects of medication.
- (d) HIV positivity
  - (1) Rescue and firefighting personnel who are HIV positive may be assessed as fit if a full investigation provides no evidence of HIV-associated diseases that might give rise to incapacitating symptoms. Frequent review of the immunological status and a neurological evaluation by an appropriate specialist needs to be carried out. A cardiological review may also be required depending on medication.
  - (2) Rescue and firefighting personnel with an AIDS-defining condition are assessed as unfit except in individual cases for limited duties after complete recovery and dependent on the review.
  - (3) The assessment of cases under (1) and (2) is dependent on the absence of symptoms or signs of the disease and the acceptability of serological markers. Treatment will be evaluated by a specialist on an individual basis for its appropriateness and any side effects.
- (e) Syphilis

Rescue and firefighting personnel with acute syphilis are assessed as unfit. A fit assessment may be considered in the case of those fully treated and recovered from the primary and secondary stages.
- (f) Infectious hepatitis

Rescue and firefighting personnel with infectious hepatitis are assessed as unfit. A fit assessment may be considered once the person has become asymptomatic after treatment and a specialist evaluation. Regular review of the liver function needs to be carried out.

## **8. OBSTETRICS AND GYNECOLOGY**

- (a) Gynaecological surgery

Rescue and firefighting personnel who have undergone a major gynaecological surgery undergo a specialist assessment. A fit assessment can be considered subject to a satisfactory gynaecological evaluation after successful treatment and/or full recovery after a surgery.
- (b) Pregnancy

In the case of pregnancy, rescue and firefighting personnel are assessed as unfit. A fit assessment may be considered after the 12th week of gestation provided that obstetric evaluation continuously indicates a normal pregnancy. Such a fit assessment is valid until the 30th week of gestation. Additional operational limitations may be imposed. A fit assessment

may be considered following a specialist assessment after full recovery following the end of the pregnancy.

## **9. MUSCULOSKELETAL SYSTEM**

- (a) Rescue and firefighting personnel will have satisfactory functional use of the musculoskeletal system to enable them to safely perform their duties.
- (b) Rescue and firefighting personnel with static or progressive musculoskeletal or rheumatologic conditions or a surgery likely to interfere with the safe performance of their duties will undergo further assessment. A fit assessment can be considered subject to a satisfactory workplace assessment after successful treatment or full recovery after a surgery.
- (c) Rescue and firefighting personnel with a limb prosthesis should have satisfactory functional use as demonstrated by a workplace assessment.
- (d) Rescue and firefighting personnel with any significant sequelae from disease, injury or congenital abnormality affecting the bones, joints, muscles or tendons with or without a surgery need to have a full evaluation prior to a fit assessment.
- (e) Abnormal physique, including obesity, or muscular weakness may require a medical assessment and particular attention needs to be paid to workplace assessment.
- (f) Locomotor dysfunction, amputations, malformations, loss of function and progressive osteoarthritic disorders are assessed on an individual basis in conjunction with the appropriate operational expert with a knowledge of the complexity of the tasks of that need to be performed.
- (g) Rescue and firefighting personnel with inflammatory, infiltrative, or degenerative disease of the musculoskeletal system may be assessed as fit provided that the condition is in remission and the medication is acceptable and does not adversely affect the discharge of their duties.
- (h) For rescue and firefighting personnel who have undergone a reconstructive surgery or joint replacement procedures, particular attention will be paid to the risks associated with the particular implant or prosthesis and its functional operational range.
- (i) Where there is doubt about the operational fitness, rescue and firefighting personnel undergo the operational physical fitness assessment prior to a return to full duties. A limitation (or limitations) may be required.

## **10. PSYCHIATRY**

- (a) Rescue and firefighting personnel with a mental or behavioural disorder due to alcohol or other use or misuse of psychoactive substances, including recreational substances with or without dependency, are assessed as unfit until after a period of documented sobriety or freedom from psychoactive substance use or misuse and subject to a satisfactory psychiatric evaluation after successful treatment.
- (b) Rescue and firefighting personnel with a psychiatric condition such as:
  - (1) mood disorder;
  - (2) neurotic disorder, e.g. claustrophobic or acrophobic symptoms;
  - (3) personality disorder;
  - (4) mental or behavioural disorder;

- (5) post-traumatic stress disorder;
- (6) significant stress-related symptoms; and
- (7) single or repeated acts of deliberate self-harm,

will undergo treatment, as necessary, and a satisfactory psychiatric assessment before a fit assessment can be considered. A psychological evaluation may be required as part of, or complementary to, a specialist psychiatric or neurological assessment.

(c) Disorders due to alcohol or other substance use

- (1) A fit assessment may be considered after successful treatment, a period of documented sobriety or freedom from substance use, and review by a psychiatric specialist. The OHMP, with the advice of the psychiatric specialist, will determine the duration of the period to be observed before a fit assessment can be made.
- (2) Depending on the individual case, treatment may include inpatient treatment of variable duration.
- (3) Continuous follow-up, including blood testing and peer reports, may be required indefinitely.

(d) Mood disorder

Rescue and firefighting personnel with an established mood disorder are assessed as unfit. After full recovery and after full consideration of an individual case, a fit assessment may be considered, depending on the characteristics and gravity of the mood disorder. If stability on maintenance psychotropic medication is confirmed, a fit assessment may be considered. In some cases, an operational limitation may be required. If the dosage of the medication is changed, a further period of unfit assessment is required. Regular specialist supervision needs to be considered. Any use of medication needs to be evaluated further by a specialist.

(e) Psychotic disorder

Rescue and firefighting personnel with a history, or the occurrence, of a functional psychotic disorder are assessed as unfit unless it can be confirmed that the original diagnosis was inappropriate or inaccurate or was a result of a single toxic episode.

(f) Deliberate self-harm

A single self-destructive action or repeated overt acts entail unfitness. A fit assessment may be considered after full consideration of an individual case and requires psychiatric or psychological review.

## 11. NEUROLOGY

(a) Rescue and firefighting personnel with an established history or clinical diagnosis of:

- (1) epilepsy except in the cases in (b)(1) and (2) below;
  - (2) recurring episodes of disturbance of consciousness of uncertain cause; and
  - (3) conditions with a high propensity for cerebral dysfunction,
- are assessed as unfit.

(b) Rescue and firefighting personnel with an established history or clinical diagnosis of:

- (1) epilepsy without recurrence after the age of 5;



- (2) epilepsy without recurrence and off all treatment for more than 5 years;
- (3) epileptiform EEG abnormalities and focal slow waves;
- (4) progressive or non-progressive disease of the nervous system;
- (5) a single episode of disturbances or loss of consciousness;
- (6) brain injury, affliction or inflammation;
- (7) spinal or peripheral nerve injury, affliction or inflammation;
- (8) disorders of the nervous system due to vascular deficiencies including haemorrhagic and ischaemic events; and
- (9) vertigo,

need to undergo a specialist evaluation before a fit assessment may be considered.

(c) Electroencephalography (EEG)

EEG will be carried out based on the person's history or on clinical grounds.

(d) Epilepsy

- (1) Rescue and firefighting personnel who have experienced one or more convulsive episodes after the age of 5 are assessed as unfit.
- (2) A fit assessment may be considered if:
  - (i) the rescue and firefighting personnel are seizure free and off medication for at least 5 years; and
  - (ii) a full neurological evaluation shows that a seizure was caused by a specific non-recurrent cause, such as trauma or toxin.
- (3) Rescue and firefighting personnel who have experienced an episode of benign Rolandic seizure may be assessed as fit provided that the seizure has been clearly diagnosed including a properly documented history and typical EEG result and the rescue and firefighting personnel have been free of symptoms and off treatment for at least 5 years.

(e) Neurological disease

Rescue and firefighting personnel with any stationary or progressive disease of the nervous system which has caused or is likely to cause a significant disability are assessed as unfit. A fit assessment may be considered in cases of minor functional losses associated with stationary disease after a full neurological evaluation and a workplace assessment. An operational limitation may be required.

(f) Disturbance of consciousness

Rescue and firefighting personnel with a history of one or more episodes of disturbed consciousness may be assessed as fit if the condition can be satisfactorily explained by a non-recurrent cause. Operational limitations may be imposed. A full neurological evaluation is necessary.

(g) Head injury

Rescue and firefighting personnel with a head injury which was severe enough to cause loss of consciousness will be evaluated by a consultant neurologist. A fit assessment may be considered

if there has been a full recovery and the risk of post-traumatic epilepsy has fallen to a sufficiently low level. Behavioural and cognitive aspects will be taken into account where there is evidence of significant penetrating brain trauma or contusion.

## **12. VISUAL SYSTEM**

- (a) Distant and near visual acuity, with or without optimal correction, will be 6/9 (0.7) or better in each eye separately, and visual acuity with both eyes will be 6/6 (1) or better.
- (b) Rescue and firefighting personnel need to have fields of vision and binocular function appropriate to the operational tasks.
- (c) Rescue and firefighting personnel at the initial assessment having monocular or functional monocular vision, including eye muscle balance problems, may be assessed as fit provided that an ophthalmological examination and an operational evaluation are satisfactory. Operational limitations may be necessary.
- (d) Rescue and firefighting personnel who have undergone an eye surgery are assessed as unfit until full recovery of the visual function. A fit assessment may be considered subject to a satisfactory ophthalmologic evaluation.
- (e) Rescue and firefighting personnel with a clinical diagnosis of keratoconus may be assessed as fit subject to a satisfactory examination by an ophthalmologist.
- (f) Rescue and firefighting personnel with diplopia are assessed as unfit.
- (g) Corrective lenses

If satisfactory visual function for the rescue and firefighting duties is achieved only with the use of correction, the spectacles, inserts or contact lenses must provide optimal visual function, be well tolerated, and suitable for rescue and firefighting duties, including the wearing of breathing apparatus.

- (h) Eye examination

### **STANDARD TESTS FOR VISION**

- (1) At each medical examination, an assessment of vision will be undertaken and the eyes are examined with regard to possible pathology.
- (2) The routine eye examination includes:
  - (i) history;
  - (ii) visual acuities — near and distant vision; uncorrected and with best optical correction if needed;
  - (iii) morphology by ophthalmoscopy; and
  - (iv) further examination on clinical indication.
- (3) Visual acuity is tested using Snellen charts, or equivalent, under appropriate illumination. Where clinical evidence suggests that Snellen may not be appropriate, Landolt 'C' may be used.
- (4) All abnormal and doubtful cases are referred to an ophthalmologist. Conditions which indicate a comprehensive ophthalmological examination include, but are not limited to, a substantial decrease in the uncorrected visual acuity, any decrease in best corrected visual acuity, and/or the occurrence of eye disease, eye injury, or eye surgery.

- 
- (5) In case of multiple pathological conditions of the eye, their effect is evaluated by an ophthalmologist with regard to possible cumulative effects. Functional testing in the working environment may be necessary to consider a fit assessment.
- (i) Refractive error
- Rescue and firefighting personnel without symptoms with high refractive error in excess of +5.0/-6.0 dioptres, high anisometropia >3D, or high astigmatism >3D may be assessed as fit provided that the visual standards are met in both eyes, optimal correction has been considered and no significant pathology is demonstrated. Risk of visual incapacitation arising from the refractive error or shape of the eye may be acceptable.
- (j) Substandard vision
- Rescue and firefighting personnel with reduced central vision in one eye may be assessed as fit if the binocular visual field is normal and the underlying pathology is acceptable according to an ophthalmological evaluation. Testing includes functional testing in the appropriate working environment.
- (k) Heterophoria
- Rescue and firefighting personnel with heterophoria (imbalance of the ocular muscles) will undergo further ophthalmological evaluation before a fit assessment is considered.
- (l) Eye surgery
- (1) Refractive surgery
- After a refractive surgery or a surgery of the cornea including cross linking, a fit assessment may be considered, provided that:
- (i) the pre-operative refraction was less than +5 dioptres;
  - (ii) satisfactory stability of refraction has been achieved (less than 0.75 dioptres variation diurnally);
  - (iii) the examination of the eye shows no post-operative complications;
  - (iv) the glare sensitivity is normal;
  - (v) the mesopic contrast sensitivity is not impaired; and
  - (vi) the specialist evaluation is undertaken by an ophthalmologist.
- (2) Cataract surgery
- Rescue and firefighting personnel who have undergone a cataract surgery may be assessed as fit after 6 weeks provided that the visual requirements are met either with corrective lenses, or with intraocular lenses which are non-tinted.
- (3) Retinal surgery/retinal laser therapy
- (i) After a retinal surgery, rescue and firefighting personnel may be assessed fit 6 months after a successful surgery. Annual ophthalmological follow-up may be necessary. Longer periods may be acceptable after 2 years on recommendation of the ophthalmologist.
  - (ii) After successful retinal laser therapy, rescue and firefighting personnel may be assessed as fit provided that an ophthalmological evaluation shows stability.

(4) Glaucoma surgery

After a glaucoma surgery, rescue and firefighting personnel may be assessed as fit 6 months after a successful surgery. Ophthalmological examinations undertaken every 6 months to follow-up secondary complications caused by the glaucoma may be necessary.

(5) Extraocular muscle surgery

A fit assessment may be considered not less than 6 months after a surgery and after a satisfactory ophthalmological evaluation.

(6) Visual correction

Spectacles, contact lenses and mask inserts should permit the rescue and firefighting personnel to meet the visual requirements at all distances.

#### COLOUR VISION

(a) Rescue and firefighting personnel who fail to correctly identify 9 or more of the first 15 plates of the 24-plate edition of Ishihara pseudoisochromatic plates undergo further specialist evaluation. A fit assessment may be considered if the results of the evaluation and/or operational testing demonstrate that the duties can be performed safely.

(b) Advanced or fictional colour vision testing is assessed using means able to demonstrate acceptable colour vision.

#### 13. OTORHINOLARYNGOLOGY

(a) Rescue and firefighting personnel do not have a hearing loss of more than 35 dB at any of the frequencies 500, 1 000 or 2 000 Hz, and 50 dB at 3 000 Hz, in either ear separately.

(b) Rescue and firefighting personnel who do not meet the hearing criteria above will undergo a specialist assessment before a fit assessment may be considered. In these cases, the rescue and firefighting personnel undergo a functional hearing test in the operational environment. Initial candidates who do not meet the hearing criteria above will undergo a speech discrimination test.

(c) Hearing aids

A fit assessment may be considered if the use of a hearing aid (or aids) or of an appropriate prosthetic aid improves the hearing to achieve a normal standard as assessed by fully functional testing in the operational environment.

(d) Rescue and firefighting personnel with:

- (1) an active chronic pathological process of the internal or middle ear;
- (2) unhealed perforation or dysfunction of the tympanic membrane(s);
- (3) disturbance of vestibular function;
- (4) significant malformation or significant chronic infection of the oral cavity or upper respiratory tract; and
- (5) significant disorder of speech or voice reducing intelligibility,

will undergo further specialist examination and assessment to establish that the condition does not interfere with the safe performance of their duties.

(e) Examination

- (1) An otorhinolaryngological examination includes:
  - (i) history;
  - (ii) clinical examination including otoscopy, rhinoscopy, and examination of the mouth and throat; and
  - (iii) clinical assessment of the vestibular system.
- (2) ENT specialists involved in the assessment of rescue and firefighting personnel should have an understanding of the functionality required.
- (3) Where a full assessment and functional check is needed, due regard is paid to the operating environment in which the operational functions are undertaken.

(f) Hearing

- (1) The follow-up of a rescue and firefighting personnel with hypoacusis is decided by the medical staff. If at the next annual test there is no indication of further deterioration, the normal frequency of testing may be resumed.
- (2) Full functional and environmental assessments is carried out with the chosen prosthetic equipment in use.

(g) Ear conditions

Rescue and firefighting personnel with perforation is considered unfit. A fit assessment can be made following a specialist evaluation, treatment and full recovery.

(h) Vestibular disturbance

The presence of vestibular disturbance with vertigo (e.g. Meniere's disease) and spontaneous or positional nystagmus requires a complete vestibular evaluation by a specialist and entails unfitness until successful treatment and/or full recovery.

(i) Speech disorder

Rescue and firefighting personnel with a speech disorder are assessed with due regard to the operational environment in which the operational functions are undertaken. Rescue and firefighting personnel with significant disorder of speech or voice are assessed as unfit.

#### **14. DERMATOLOGY**

- (a) Rescue and firefighting personnel will not have any established dermatological condition likely to interfere with the safe performance of their duties and the wearing of protective equipment. A fit assessment could be considered following a specialist dermatological assessment.
- (b) Systemic effects of radiation or pharmacological treatment for a dermatological condition will be evaluated before a fit assessment can be considered.
- (c) Rescue and firefighting personnel with a skin condition that causes pain, discomfort, irritation or itching may only be assessed as fit if the condition can be controlled and does not interfere with the safe performance of the duties and with wearing of personal protective equipment.
- (d) In cases where a dermatological condition is associated with a systemic illness, full consideration will be given to the underlying illness before a fit assessment may be considered.

**15. ONCOLOGY**

- (a) After diagnosis of primary or secondary malignant disease, rescue and firefighting personnel are assessed as unfit.
- (b) After completion of primary treatment and full recovery, the rescue and firefighting personnel will undergo a specialist evaluation before a fit assessment could be considered.
- (c) Rescue and firefighting personnel with an established history or clinical diagnosis of a malignant intracerebral or pulmonary tumor are assessed as unfit.
- (d) Rescue and firefighting personnel who have been diagnosed with malignant disease may be assessed as fit provided that:
  - (1) after primary treatment, there is no evidence of residual malignant disease likely to interfere with the performance of duties;
  - (2) time appropriate to the type of tumour has elapsed since the end of the primary treatment;
  - (3) the risk of incapacitation from a recurrence or metastasis is sufficiently low;
  - (4) there is no evidence of short- or long-term sequelae from treatment. Special attention should be paid to cardiac risk in persons who have received anthracycline chemotherapy; and
  - (5) satisfactory oncology follow-up reports are provided to the medical staff.
- (e) Rescue and firefighting personnel receiving ongoing chemotherapy (other than adjuvant preventative therapy) or radiation treatment are assessed as unfit.
- (f) Rescue and firefighting personnel with a benign intracerebral tumour may be assessed as fit after a satisfactory specialist and neurological evaluation and provided that the condition does not compromise the safe performance of duties.
- (g) Rescue and firefighting personnel with pre-malignant conditions may be assessed as fit if treated or excised as necessary and there is a regular follow-up.

**GM3 ADR.OPS.B.010(a)(4) Rescue and firefighting services***ED Decision 2020/009/R***PHYSICAL FITNESS EVALUATION PROGRAMME**

The physical fitness of rescue and firefighting personnel will be evaluated at regular intervals. For this reason, a physical fitness evaluation programme is necessary.

The evaluation should be anti-discriminatory, non-punitive or non-competitive. The results of the evaluation may be used to establish the person's baseline or measured against the person's previous assessments.

A physical fitness evaluation will also be considered following significant absence, illness or injury prior to a return to operational duty.

The physical fitness evaluation includes:

- (a) a pre-evaluation health questionnaire;
- (b) an evaluation of aerobic capacity; and

- (c) an evaluation of muscular strength, endurance and flexibility.

#### PRE-EVALUATION PROCEDURE

- (a) Rescue and firefighting personnel complete a pre-assessment screening questionnaire to identify contraindications for participation in the fitness assessment.
- (b) If rescue and firefighting personnel have an incapacitating medical problem or a newly acquired chronic medical condition, the physical fitness assessment will be postponed until the rescue and firefighting personnel have been assessed as fit by the medical staff. In such circumstances, the rescue and firefighting personnel are assessed as unfit.

#### FITNESS TESTS

Individual physical fitness is tested as follows:

- (a) Operational fitness tests

Physical fitness is evaluated using appropriate standard protocols. The physical fitness test ensure that the rescue and firefighting personnel are able to effectively demonstrate the following representative operational competencies:

- (1) Stair or ladder climbing while carrying an additional load;
- (2) Ladder raise and extension;
- (3) Equipment carry;
- (4) Rescue drag;
- (5) Operating in an enclosed space;
- (6) Hose drill and operations;
- (7) Operating in a high temperature environment with breathing apparatus; and
- (8) Aerobic fitness assessment:
  - (i) For full operational duties, a VO<sub>2</sub> Max of at least the firefighters' average or better for age and gender and not less than 35 ml/kg/min is recommended.
  - (ii) The estimation of VO<sub>2</sub> Max may be performed using the following tests
    - (A) Shuttle run;
    - (B) Validated step test, e.g. Cooper, Chester;
    - (C) Cycle ergometer;
    - (D) Treadmill; and
    - (E) Full spiro-ergometry

The above functions may be included as part of an operational exercise or carried out separately.

- (b) Simulated operational physical fitness tests

Tests conducted in an appropriate facility may be used as an alternative for new recruits, untrained personnel or where the operational test is unavailable and where there is evidence that the simulated tests are a reasonable representation of operational tasks. The choice of the appropriate test depends on various aspects such as ease of administration, safety, cost and

predictive value. The following methods may be used for the fitness evaluation of rescue and firefighting personnel:

- (1) Muscular strength
  - (i) Handgrip dynamometer;
  - (ii) Static bicep curl with dynamometer;
  - (iii) Lat pull;
  - (iv) Static leg press with dynamometer;
  - (v) Bench press; and
  - (vi) Leg press.
- (2) Muscular endurance
  - (i) Push-ups, modified push-ups;
  - (ii) Pull-ups;
  - (iii) Bent knee sit-ups; and
  - (iv) Crunches in a given time, crunches to cadence.
- (3) Flexibility
  - (i) Sit and reach, modified sit and reach;
  - (ii) Trunk extension; and
  - (iii) Shoulder elevation.

## **AMC1 ADR.OPS.B.010(c) Rescue and firefighting services**

*ED Decision 2021/003/R*

### **RULES AND PROCEDURES**

- (a) The aerodrome operator should ensure that rescue and firefighting personnel are aware of the rules and procedures relevant to operation of the aerodrome and the relationship of their duties and responsibilities to the aerodrome operation as a whole.
- (b) Proficiency checks should verify that rescue and firefighting personnel are aware of the rules and procedures relevant to their duties and responsibilities.

## **AMC1 ADR.OPS.B.010(d) Rescue and firefighting services**

*ED Decision 2021/003/R*

### **TRAINING OF RESCUE AND FIREFIGHTING PERSONNEL**

The training of rescue and firefighting personnel may include training in, at least, the following areas:

- (a) aerodrome familiarisation;
- (b) aircraft familiarisation;
- (c) rescue and firefighting personnel safety;
- (d) emergency communications systems on the aerodrome, including aircraft fire-related alarms;



- (e) use of the fire hoses, nozzles, turrets, and other appliances;
- (f) application of the types of extinguishing agents required;
- (g) emergency aircraft evacuation assistance;
- (h) firefighting operations;
- (i) adaptation and use of structural rescue and firefighting equipment for aircraft rescue and firefighting;
- (j) dangerous goods;
- (k) familiarisation with fire fighters' duties under the aerodrome emergency plan;
- (l) low visibility procedures;
- (m) human performance, including team coordination;
- (n) protective clothing and respiratory protection;
- (o) composite materials; and
- (p) recognition of aircraft ballistic parachute systems during emergency operations.

## **AMC2 ADR.OPS.B.010(d) Rescue and firefighting services**

*ED Decision 2021/003/R*

### **TRAINING PROGRAMME OF RFFS PERSONNEL — GENERAL**

The aerodrome operator should ensure that:

- (a) rescue and firefighting personnel actively participate in live fire drills commensurate with the types of aircraft, and type of rescue and firefighting equipment in use at the aerodrome, including pressure-fed jet fuel fire drills or any other type of fuel, provided that they apply the same extinguishing techniques as for jet fuel; and
- (b) the rescue and firefighting personnel training programme includes training in human performance, including team coordination.

## **ADR.OPS.B.015 Monitoring and inspection of movement area and related facilities**

*Regulation (EU) No 139/2014*

- (a) The aerodrome operator shall monitor the condition of the movement area and the operational status of related facilities and report on matters of operational significance, whether of a temporary or permanent nature, to the relevant air traffic services providers and aeronautical information services providers.
- (b) The aerodrome operator shall carry out regular inspections of the movement area and its related facilities.

## AMC1 ADR.OPS.B.015 Monitoring and Inspection of movement area and related facilities

*ED Decision 2014/012/R*

### GENERAL

- (a) The aerodrome operator should establish a monitoring and inspection program of the movement area which is commensurate with the traffic expected at the aerodrome in order to identify any default or potential hazards to the safety of aircraft or aerodrome operations.
- (b) Inspections of the movement area covering items such as the presence of FOD, the status of visual aids, wildlife and current surface conditions, should be carried out each day, at least, once where the code number is 1 or 2, and, at least, twice where the code number is 3 or 4.
- (c) Inspections covering other items such as other lighting systems required for the safety of aerodrome operations, pavements and adjacent ground surfaces, drainage and storm water collection systems, fencing and other access control devices, the movement area environment inside the aerodrome boundary and outside the aerodrome boundary within line of sight, should be carried out, at least, weekly.
- (d) The aerodrome operator, during excessive weather events (excessive heat, freeze and thaw periods, following a significant storm, etc.) should be conducting extra inspections of paved areas to check for pavement blow-ups and debris that could damage aircraft, or cause pilots to lose directional control.
- (e) The aerodrome operator should keep a log for all routine and non-routine inspections of the movement area and related facilities.

## AMC2 ADR.OPS.B.015 Monitoring and inspection of movement area and related facilities

*ED Decision 2021/003/R*

### REQUIREMENTS AND PROCEDURES FOR MOVEMENT AREA INSPECTIONS

- (a) The aerodrome operator should designate the personnel responsible for carrying out movement area inspections.
- (b) The aerodrome operator should ensure that all vehicles on the manoeuvring area are in radio contact with the appropriate air traffic services either directly or through an escort.
- (c) In order to prevent runway incursions, the aerodrome operator should have procedures in place, which have been coordinated with the air traffic services unit, for conducting runway inspections, communication procedures, actions in case of radio communication or transponder failure or vehicle breakdown, stop bars crossing, including in cases of stop bar unserviceability, runway crossings, etc. Runway inspections should be conducted in the opposite direction to that being used for landing or taking off and without interruption, unless it is operationally impossible. The inspection procedures should also cater for the temporary suspension of runway operations to allow a full runway inspection to be carried out without interruption, and should address the need to effectively inspect unidirectional lights.
- (d) The aerodrome operator should ensure that personnel conducting movement area inspections should be trained in, at least, the following areas:
  - (1) aerodrome familiarisation, including aerodrome markings, signs, and lighting;

- (2) Aerodrome Manual;
  - (3) Aerodrome Emergency Plan;
  - (4) Notice to Airmen (NOTAM) initiation procedures;
  - (5) aerodrome driving rules;
  - (6) procedures for radiotelephony, phraseology and ICAO phonetic alphabet;
  - (7) aerodrome inspection procedures and techniques;
  - (8) procedures for reporting inspection results and observations;
  - (9) air traffic services procedures on the movement area; and
  - (10) low-visibility procedures.
- (e) Personnel conducting runway surface condition assessments, in addition to the training specified in point (d) above, should be trained in, at least, the following areas:
- (1) procedures for completion/initiation of RCR;
  - (2) type of runway contaminants and reporting;
  - (3) assessment and reporting of runway surface friction characteristics;
  - (4) use, calibration and maintenance of runway friction measurement device, where applicable;
  - (5) awareness of uncertainties related to point (4) above; and
  - (6) awareness of the impact of runway surface condition assessment on aircraft performance.
- (f) Following the successful completion of the theoretical training, the practical part of the training to be provided should take into account the individual needs of the trainees, and should include the practical application of the theoretical training. After the completion of the practical training, a competency assessment should take place (see [AMC1 ADR.OR.D.017\(e\)](#)).

## GM1 ADR.OPS.B.015 Monitoring and inspection of movement area and related facilities

*ED Decision 2014/012/R*

### PAVEMENTS AND ADJACENT GROUND SURFACES INSPECTION

(a) Paved Areas Inspection

The following should be observed during an inspection of paved areas:

- (1) general cleanliness with particular attention to material which could cause engine ingestion damage. This may include debris from runway maintenance operations, or excessive grit remaining after runway gritting;
- (2) presence of contaminants such as snow, slush, ice, wet ice, wet snow on ice or frost, water, anti-icing or de-icing chemicals, mud, dust, sand, volcanic ash, oil, rubber deposits which may impair the runway surface friction characteristics; particular attention should be given to the simultaneous presence of snow, slush, ice, wet ice, wet snow on ice with anti-icing or de-icing chemicals;

- (3) signs of damage to the pavement surface including cracking and spall of concrete, condition of joint sealing, cracking and looseness of aggregate in asphalt surfaces, or break-up of friction courses;
  - (4) after rain, flooded areas should be identified and marked, if possible, to facilitate later resurfacing;
  - (5) damage of light fittings;
  - (6) cleanliness of runway markings;
  - (7) the condition and fit of pit covers; and
  - (8) the extremities of the runway should be inspected for early touchdown marks; blast damage to approach lights, marker cones and threshold lights; cleanliness and obstacles in the runway end safety area.
- (b) Adjacent ground surfaces inspection
- The following may be observed during the inspection:
- (1) the general state of ground cover vegetation ensuring, in particular, that excessive length is not obscuring lights, signs, markers, etc.;
  - (2) any developing depressions should be noted and plotted;
  - (3) any unreported aircraft wheel tracks should be carefully plotted and reported;
  - (4) the condition of signs and markers;
  - (5) the general bearing strength of grass areas, particularly those close to aircraft pavement surface;
  - (6) waterlogged grass areas; and
  - (7) FOD and wildlife.

## **GM2 ADR.OPS.B.015 Monitoring and inspection of movement area and related facilities**

*ED Decision 2021/003/R*

### **OBSTACLES**

- (a) All authorised obstacles should be checked for proper lighting and marking.
- (b) Any unauthorised obstacles should be reported to the designated persons or organisations immediately.

## **GM3 ADR.OPS.B.015 Monitoring and inspection of movement area and related facilities**

*ED Decision 2021/003/R*

### **INSPECTION LOG**

The inspection log should include:

- (a) details of inspection intervals and times;

- (b) names of persons carrying out the inspection; and
- (c) results and observations, if any.

## GM4 ADR.OPS.B.015 Monitoring and inspection of movement area and related facilities

*ED Decision 2021/003/R*

### FOLLOW-UP OF INSPECTIONS

Arrangements should exist for reporting the results of inspections, and for taking prompt follow-up actions to ensure correction of unsafe conditions. These arrangements could include, depending on the result or observation, notification to air traffic services and aeronautical information services, removal of FODs, wildlife control, recording of events for further analysis according to the aerodrome operator's SMS requirements, etc.

## GM5 ADR.OPS.B.015 Monitoring and inspection of movement area and related facilities

*ED Decision 2021/003/R*

### PERSONNEL REQUIREMENTS FOR MOVEMENT AREA INSPECTIONS

- (a) Inspectors should use checklists covering the various inspection areas. A sketch of the aerodrome should accompany the checklist so that the location of problems can be marked for easy identification.
- (b) Inspectors should review the most recently completed checklist from the previous inspection cycle prior to beginning the inspection.
- (c) If construction or works are in progress, inspectors should be familiar with the safety plan of the construction or works.

## GM6 ADR.OPS.B.015 Monitoring and inspection of movement area and related facilities

*ED Decision 2021/003/R*

### RECURRENT, REFRESHER AND CONTINUATION TRAINING

[ADR.OR.D.017](#) point (f) regulates the provision of training following the completion of the initial training, as part of the aerodrome operator's training programme. For the process that needs to be followed to ensure the continued competence of the personnel, see [ADR.OR.D.017\(f\)](#) and [AMC1 ADR.OR.D.017\(f\)](#).

## ADR.OPS.B.016 Foreign object debris control programme

*Delegated Regulation (EU) 2020/2148*

- (a) The aerodrome operator shall establish and implement a foreign object debris (FOD) control programme and shall require organisations operating or providing services at the aerodrome to participate in that programme.
- (b) As part of the FOD control programme, the aerodrome operator shall:

- (1) ensure personnel awareness and participation, and that such personnel have successfully completed relevant training and demonstrated their competence;
- (2) establish and implement measures to prevent generation of FOD;
- (3) establish and implement procedures to:
  - (i) detect FOD, including the monitoring and inspection of the movement area or adjacent areas in accordance with an inspection schedule and whenever such an inspection is required due to activities, weather phenomena, or occurrences that may have led to the generation of FOD;
  - (ii) promptly remove, contain, and dispose of FOD, and provide all relevant means necessary;
  - (iii) notify, as soon as possible, aircraft operators in the case of identified aircraft parts;
- (c) collect and analyse data and information to identify FOD sources and trends, and implement corrective or preventive measures, or both, to improve the effectiveness of the programme.

## AMC1 ADR.OPS.B.016(a) Foreign object debris control programme

ED Decision 2021/003/R

### FOD CONTROL PROGRAMME — GENERAL

The FOD control programme should be actively supported by the senior management of the aerodrome operator and of the other organisations operating or providing services at the aerodrome. The aerodrome operator should designate an individual within the aerodrome organisation to manage the aerodrome's FOD control programme.

## AMC1 ADR.OPS.B.016(b)(1) Foreign object debris control programme

ED Decision 2021/003/R

### FOD PREVENTION

#### (a) Personnel awareness

Personnel should be kept aware through appropriate activities of the existence of the FOD control programme, and should be actively encouraged to identify and report potential FOD hazards, act to remove observed FOD, and propose solutions to mitigate related safety risks.

#### (b) Personnel training

The FOD training programme should aim at increasing the personnel awareness of the causes and effects of FOD damage and to promote their active participation in eliminating FOD during the performance of daily work routines.

- (1) The theoretical part of the initial FOD training programme should cover the following areas:
  - (i) safety of aircraft, personnel and passengers as they relate to FOD;
  - (ii) overview of the FOD control programme in place at the aerodrome;
  - (iii) causes and principal contributing factors of FOD creation;

- (iv) the consequences of ignoring FOD, and/or the incentives for preventing FOD;
- (v) practising 'clean-as-you-go' work habits and the general cleanliness and inspection standards of work areas;
- (vi) FOD detection procedures, including the proper use of detection technologies (if applicable);
- (vii) requirements and procedures for the regular inspection and cleaning of movement areas;
- (viii) FOD removal procedures;
- (ix) proper care, use, and stowage of material and component or equipment items used around aircraft while in servicing, maintenance or on aerodrome surfaces;
- (x) control of debris in the performance of work assignments;
- (xi) control over personal items and equipment;
- (xii) proper control/accountability and care of tools and hardware;
- (xiii) how to report FOD incidents or potential incidents; and
- (xiv) continuous vigilance for potential sources of FOD.

The theoretical training should be followed by an assessment of the trainees (see [AMC1 ADR.OR.D.017\(e\)](#)).

- (2) Following the successful completion of the theoretical training, the practical part of the training to be provided should take into account the individual needs of the trainees, according to the responsibilities/tasks of the personnel, and, as a minimum, should include familiarisation with the tools/equipment used for the removal/containment/prevention of FOD, and the implementation of the relevant aerodrome operating procedures related to the programme. Following the completion of the practical training, a competency assessment should take place (see [AMC1 ADR.OR.D.017\(e\)](#)).

## **GM1 ADR.OPS.B.016(b)(1) Foreign object debris control programme**

*ED Decision 2021/003/R*

### **RECURRENT, REFRESHER AND CONTINUATION TRAINING**

[ADR.OR.D.017](#) point (f) regulates the provision of training following the completion of the initial training, as part of the aerodrome operator's training programme. For the process that needs to be followed to ensure the continued competence of the personnel, see [ADR.OR.D.017\(f\)](#) and [AMC1 ADR.OR.D.017\(f\)](#).

## AMC1 ADR.OPS.B.016(b)(2) Foreign object debris control programme

*ED Decision 2021/003/R*

### FOD PREVENTION — MEASURES

The aerodrome operator should identify activities that may be associated with the generation of FOD, as well as measures that should be taken in order to prevent this from happening. A record of the analysis made should be maintained.

## GM1 ADR.OPS.B.016(b)(2) Foreign object debris control programme

*ED Decision 2021/003/R*

### FOD PREVENTION — MEASURES

FOD may be produced by many activities and may be generated by personnel, aerodrome infrastructure (pavements, lights and signs), the environment (e.g. wind, heavy rain), aircraft, vehicles, or other equipment operating at the aerodrome. The elements below have also the potential to become sources of FOD on an aerodrome.

(a) Aircraft servicing and maintenance activities

During the activities related to the aircraft servicing, various types of FOD may be generated and be left or transferred on the apron, service roads, and other operational areas. Such items may include small luggage parts, cabin waste, plastic or metallic items, etc. FOD may also be generated by vehicles or the equipment that operates in these areas.

To control this type of FOD, measures need to include securing and removing cabin waste from the aircraft stand. Cabin waste would not be left unattended on the apron, especially near aircraft stands. Moreover, cabin waste need not be disposed of using the FOD containers provided, as cabin waste may attract wildlife. To this end, the handling of cabin waste would be organised so that a damage of the rubbish bag is not likely to attract wildlife on the apron.

Similarly, during aircraft maintenance, FOD may be generated either in the form of waste or small items inadvertently left on the apron such as rivets, bolts, tools, etc. Procedures to address this may include measuring of tools, use of toolboxes, checklists, removal of waste produced upon the completion of the maintenance activities, etc.

Inspection of the aircraft stand or other areas that may have been used for aircraft servicing or maintenance, before and after the departure of the aircraft is an effective measure. The secure installation of suitable FOD bins, in appropriate locations, for depositing FOD is also an effective preventive measure.

(b) Cargo areas

In a cargo area, there is a high potential for blowing debris such as cargo strapping and plastic sheeting. Procedures to contain such debris, possibly by installing (and monitoring) catch fencing where appropriate, may help to control the environment. FOD trapped by such fences should be removed regularly.

(b) Construction activities

During construction activities, several materials (rocks, tools, vehicle parts, etc.) have the potential to become FOD if transferred by vehicles, weather phenomena, etc. on the movement area or other operational areas. For this reason, specific FOD prevention procedures need to be



established and employed for each construction project. These procedures would be based on the proximity of the construction activities to the movement area and other operational areas, but in general would stress containment and regular cleaning of construction debris.

Aerodrome pre-construction planning would include means for controlling and containing FOD generated by the construction. This is especially true in high-wind environments where debris is more likely to become airborne.

The designated routes of construction vehicles on the movement area need to be planned so as to avoid or minimise crossing in critical areas of aircraft operations. If high-risk crossings cannot be avoided, subsequent provisions such as an increased frequency of FOD inspections could be implemented.

Contractors need to understand and comply with the requirements regarding the control and removal of FOD. To facilitate compliance with these requirements, the aerodrome operator may consider drafting FOD control guidance for all construction projects taking place within the movement area or nearby areas. Standard and project-specific FOD measures include:

- (1) requiring contractors to cover all loads;
- (2) requiring contractors to secure any loose items that could easily blow away or control dust through spraying of water;
- (3) ensuring the proper functioning of storm drains throughout the construction;
- (4) specifying whether any mechanical FOD removal devices will be required;
- (5) specifying how monitoring for FOD hazards will be accomplished; and
- (6) requirements for inspecting and removing FOD from tyres prior to traversing operational areas.

(d) Aerodrome maintenance operations

Mowing and other maintenance operations routinely disturb the vegetation and soil in areas adjacent to those travelled by aircraft. Therefore, procedures to remove this debris, such as the use of an assigned aerodrome sweeper or personnel on foot using shovels to repair vegetation and soil, need to be implemented.

Aerodrome lighting, pavement, and marking maintenance operations may generate concrete/asphalt debris as well as increase the potential for dropped repair parts, tools, and other items stored on the maintenance vehicles. Corrective procedures may include the use of aerodrome sweepers and the inspection of the worksite after maintenance is completed.

(e) Pavements and other aerodrome surfaces may be prone to generating FOD

- (1) Pavements
  - (i) Deteriorating pavements can exhibit spalling or cracks. For example, pieces of concrete can break loose from pavements or FOD can develop from fatigue corner cracks.
  - (ii) The service roads that cross taxiways may generate FOD from the vehicles using them, especially in the case of construction operations.
  - (iii) Special attention should be paid to the cleaning of cracks and pavement joints.

- (iv) Asphalt and concrete pavements may be the most common source of FOD on an aerodrome; therefore, effective pavement maintenance practices are important for the prevention of FOD.
- (2) Other aerodrome surfaces
  - Grass areas and ditches may collect and hold large amounts of light debris such as paper, cardboard, plastic and various containers that can originate from terminal aprons, cargo ramps and hangar ramps. This debris can blow back into areas used by aircraft unless collected in a timely manner.
  - Unpaved areas adjacent to pavements may require stabilisation, as appropriate, to prevent FOD from jet wash.
  - FOD fences may collect debris on windy days. This FOD would be collected before the wind increases or changes direction and the debris blows back on to areas used by aircraft.
- (f) Vehicle operational activities
  - Vehicles used for operational reasons, e.g. preventive maintenance, wildlife management, and which may need to frequently move on surfaces that contain material that could be FOD in the movement area. Thus, procedural (e.g. inspection/cleaning of tyres) or technical (development of surfaces at predetermined points that help the removal of FOD from tyres) measures may be taken to address this potential FOD source.

## AMC1 ADR.OPS.B.016(b)(3) Foreign object debris control programme

*ED Decision 2021/003/R*

### FOD DETECTION, REMOVAL, CONTAINMENT AND DISPOSAL

- (a) The aerodrome operator should include the procedures for FOD detection in the aerodrome manual. The procedures should, where necessary, be coordinated with the air traffic services provider and should:
  - (1) ensure that FOD detection is part of the established inspection schedule of the movement area, and that:
    - (i) periodic FOD inspections on foot are carried out to increase the effectiveness of detection, and to inspect areas inaccessible by vehicle (such as grass areas);
    - (ii) additional inspections are carried out:
      - (A) in construction areas;
      - (B) immediately after any aircraft or vehicle accident or incident;
      - (C) following any material spill;
      - (D) during, and after, extreme weather events (e.g. excessive heat, freeze and thaw periods, following a significant storm, etc.);
  - (2) ensure that an inspection of an aircraft stand is carried out prior to the arrival and departure of an aircraft, in order to detect and remove any FOD present;

- (3) ensure that cabin waste is properly secured and removed from the aircraft, and any waste from aircraft maintenance activities is removed upon completion of the activities;
  - (4) ensure that FOD detection is performed in a timely manner and that it includes the identification of the FOD source and its location;
  - (5) ensure that aerodrome personnel are notified to remove detected FOD from the manoeuvring area, and describe how the air traffic services provider is notified to take appropriate action;
  - (6) describe clearly when runway or taxiway operations have to be suspended, and the coordination required with the air traffic services provider;
  - (7) ensure that FOD is removed as soon as possible after detection. FOD removal should be included in the tasks of all personnel operating on the aerodrome; and
  - (8) describe the actions required to notify aircraft operators of any aircraft parts identified.
- (b) The aerodrome operator should provide designated FOD containers and ensure that they are:
- (1) visibly placed on the apron and other areas, for the storage of debris;
  - (2) well marked, easy to identify and access, properly secured, and frequently emptied.

## **GM1 ADR.OPS.B.016(b)(3) Foreign object debris control programme**

*ED Decision 2021/003/R*

### **FOD DETECTION AND REMOVAL**

(a) FOD detection

In addition to the standard inspections, personnel on the movement area need to employ a 'clean-as-you-go' technique, by looking for FOD during their regular duties.

When inspections occur at night, additional lights/lighting systems on vehicles are beneficial to better detect FOD.

Whenever possible, vehicles involved in FOD detection activities, are only driven on clean, paved surfaces. If a vehicle needs to be driven on unpaved surfaces, the driver needs to ensure that the vehicle's tyres do not transport FOD (e.g. mud or loose stones) back onto the pavement.

Encouraging the participation of the personnel of other organisations such as air operators, groundhandling companies, air traffic services providers in inspections may reinforce the concept that FOD control is a team effort and demonstrates the aerodrome operator's commitment to a FOD-free environment. This practice may help increase familiarity with local aerodrome conditions, and promotes effective communication between the aerodrome operator and its stakeholders.

(a) FOD removal

FOD may be removed either manually or by using mechanical equipment, such as sweepers, vacuum systems, jet air blowers, magnetic bars, FOD 'sweeping carpets', etc.

FOD containers need to be able to withstand strong winds and be of a 'closed-type' to prevent the wind from dislodging their content. Suggested locations for FOD containers are: near all entry points to the apron area, in hangars, aircraft maintenance areas, near aircraft stands and baggage areas. Clearly identified FOD storage locations increase the likelihood that collected

debris will be deposited by personnel. Access to the FOD containers needs to be free by other objects.

## **AMC1 ADR.OPS.B.016(c) Foreign object debris control programme**

*ED Decision 2021/003/R*

### **FOD ANALYSIS — CONTINUOUS IMPROVEMENT**

- (a) All FOD identified and collected on the aerodrome should be recorded, analysed and evaluated. To record the location of the FODs, a grid map of the aerodrome should be used. When needed, an investigation should be carried out to identify the source of the FOD. The sources of FOD, including their location and the activities generating FOD on the aerodrome, should be identified, recorded and analysed to identify trends and problem areas as well as to focus the efforts of the FOD control programme. Relevant records, including of the actions taken, should be maintained.
- (b) The FOD control programme should be periodically reviewed to assess and continually improve its effectiveness. The programme should be updated based on the feedback received, data analysis results and trends identified through the evaluation of FOD collected at the aerodrome.

## **GM1 ADR.OPS.B.016(c) Foreign object debris control programme**

*ED Decision 2021/003/R*

### **FOD DESCRIPTION**

As FOD may be composed of different materials, when reporting, a proper description is made to allow for the proper identification of the FOD source areas, as well as for the appropriate mitigation measures to be taken.

FOD may be items from the following, non-exhaustive, list:

- (a) aircraft and engine fasteners (nuts, bolts, washers, safety wire, etc.);
- (b) aircraft parts (fuel caps, landing gear fragments, oil sticks, metal sheets, trapdoors, and tyre fragments);
- (c) mechanics' tools;
- (d) catering supplies;
- (e) personal items (personnel badges, pens, pencils, luggage tags, drink cans, etc.);
- (f) apron items (paper and plastic debris from catering and freight pallets, luggage parts, and debris from ramp equipment);
- (g) runway and taxiway materials (concrete and asphalt chunks, rubber joint materials, and paint chips);
- (h) construction debris (pieces of wood, stones, fasteners and miscellaneous metal objects);
- (i) plastic and/or polyethylene materials; and
- (j) natural materials (e.g. plant fragments, inanimate wildlife and volcanic ash).

## ADR.OPS.B.020 Wildlife strike hazard reduction

*Regulation (EU) No 139/2014*

The aerodrome operator shall:

- (a) assess the wildlife hazard on, and in the surrounding, of the aerodrome;
- (b) establish means and procedures to minimise the risk of collisions between wildlife and aircraft, at the aerodrome; and
- (c) notify the appropriate authority if a wildlife assessment indicates conditions in the surroundings of the aerodrome are conducive to a wildlife hazard problem.

## AMC1 ADR.OPS.B.020 Wildlife strike hazard reduction

*ED Decision 2014/012/R*

### GENERAL

The aerodrome operator should:

- (a) participate in the national wildlife strike hazard reduction programme;
- (b) establish procedures to record and report to the appropriate authority wildlife strikes to aircraft occurred at the aerodrome, in close cooperation with organisations operating, or providing services at the aerodrome;
- (c) ensure that wildlife hazard assessments are made by competent personnel; and
- (d) establish, implement and maintain a wildlife risk management programme.

## GM1 ADR.OPS.B.020 Wildlife strike hazard reduction

*ED Decision 2014/012/R*

### WILDLIFE RISK ASSESSMENT

- (a) The aerodrome operator should:
  - (1) conduct a risk assessment using strike data for each species, as well as information on the presence of species, the number of individuals, and their biology, and update this regularly;
  - (2) take into account the number of strikes for each species and the severity of damage arising from those strikes; and
  - (3) target actions on those species which are present with the highest frequency and create the greatest damage.
- (b) Wildlife risk assessments should be made by qualified personnel.

## GM2 ADR.OPS.B.020 Wildlife strike hazard reduction

*ED Decision 2014/012/R*

### WILDLIFE RISK MANAGEMENT PROGRAMME

The wildlife risk management programme may cover an area of approximately 13 km (7 NM) from the aerodrome reference point, and should include, at least, the following elements:

- (a) assignment of personnel:

- (1) a person who is accountable for developing and implementing the wildlife risk programme;
  - (2) a person who oversees the daily wildlife control activities, and analyses the collected data and carries out risk assessments in order to develop and implement the wildlife risk management programme; and
  - (3) trained and qualified staff who detect and record the birds/wildlife, and assess the bird/wildlife hazard, and expel hazardous birds/wildlife;
- (b) a process to report, collect, and record data of struck and living birds/wildlife;
  - (c) a process to analyse the data and to assess the bird/wildlife hazard to develop mitigation, proactive, and reactive measures. This should include a risk assessment methodology;
  - (d) a process of habitat and land management both on, and in its surroundings, whenever possible, in order to reduce the attractiveness of the area to birds/wildlife;
  - (e) a process to remove hazardous birds/wildlife;
  - (f) a process for liaison with non-aerodrome agencies and local landowners, etc. to ensure the aerodrome is aware of developments that may contribute to creating additional bird hazards within the surrounding of the aerodrome's infrastructure, vegetation, land use and activities (for example crop harvesting, seed planting, ploughing, establishment of land or water features, hunting, etc. that might attract birds/wildlife).

## **GM3 ADR.OPS.B.020 Wildlife strike hazard reduction**

*ED Decision 2014/012/R*

### **TRAINING FOR WILDLIFE CONTROL**

- (a) The aerodrome wildlife control personnel should receive formal training prior to their initial engagement as wildlife controllers.
- (b) Training for aerodrome wildlife control should be documented and records of it should be retained to satisfy periodic reviews, audits, and competence checks;
- (c) Training of aerodrome wildlife control personnel should be conducted by qualified aerodrome wildlife control personnel, or specialists with proven experience in this field.
- (d) Wildlife control initial training should, at least, address the following general areas:
  - (1) an understanding of the nature and extent of the aviation wildlife management problem, and local hazard identification;
  - (2) an understanding of the national and local regulations, standards, and guidance material related to aerodrome wildlife management programs (use of best-practice models);
  - (3) appreciation of the local wildlife ecology and biology, including (where applicable) the importance of good airfield grass management policies, and the benefits they can deliver to wildlife control;
  - (4) the importance of accurate wildlife identification and observations, including the use of field guides;
  - (5) local and national laws and regulations relating to rare and endangered species, and species of special concern, and the aerodrome operators policies relating to them;

- (6) wildlife strike remains collection, and identification policies and procedures;
  - (7) long-term (passive) control measures, including on and off aerodrome habitat management, including identification of wildlife attractions, vegetation policies, air navigation aids protection, and drainage system, and water body management practicalities;
  - (8) short-term (active) tactical measures, using well established effective wildlife removal, dispersal, and control techniques;
  - (9) documentation of wildlife activities and control measures, and reporting procedures (the aerodrome wildlife management plan);
  - (10) firearms and field safety, including the use of personal protective equipment; and
  - (11) wildlife strike risk assessment and risk management principles, and how these programs integrate with the aerodrome's safety management system.
- (e) Wildlife control staff should be fully aware of the conditions and terms of the operations of the aerodrome environment. Where this is not relevant, the wildlife control personnel should receive appropriate training, including:
- (1) aerodrome airside driver training, including aerodrome familiarisation, air traffic control communications, signs and marking, navigational aids, aerodrome operations, and safety and other matters the aerodrome operator deems appropriate; and
  - (2) aircraft familiarisation, including aircraft identification, aircraft engine design, and impact of wildlife strikes on aircraft systems.
- (f) It should be ensured that wildlife control staff maintains competence in the role. This could be achieved either by regular refresher training or another system of monitoring, acceptable to the appropriate authority. The maintenance of competence should include the areas in (d) and (e) above, and also include:
- (1) reviewing firearms safety;
  - (2) changes in the local environment;
  - (3) changes in risk management policy;
  - (4) recent wildlife events at the aerodrome;
  - (5) improvements in active and passive measures; and
  - (6) any other matters the aerodrome operator deems appropriate.

## **GM4 ADR.OPS.B.020 Wildlife strike hazard reduction**

*ED Decision 2014/012/R*

### **RECORDING AND REPORTING OF WILDLIFE STRIKES AND OBSERVED WILDLIFE**

- (a) It is necessary to maintain a record of all wildlife activity or 'bird/wildlife log'. The log should include, at least, the following information:
  - (1) numbers, species, and location of birds/wildlife seen; and
  - (2) actions taken to disperse birds/wildlife, and the results of these actions.
- (b) The log should be completed at regular intervals by the wildlife control staff.

- (c) The log should be analysed to identify which species represent a hazard, at which times of day or year, or under which weather conditions, etc.
- (d) The aerodrome operator should have a system in place to collect bird/wildlife strike reports in close cooperation with data owners, like aircraft operators, air navigation service providers, aircraft engine maintenance departments, etc.

## ADR.OPS.B.024 Authorisation of vehicle drivers

*Delegated Regulation (EU) 2020/2148*

- (a) Except as provided for in point (d), the driving of a vehicle on any part of the movement area or other operational areas of an aerodrome shall require an authorisation issued to the driver by the operator of that aerodrome. The driving authorisation shall be issued to a person who:
  - (1) is allocated tasks that involve driving in such areas;
  - (2) holds a valid driving licence, and any other licence required for the operation of specialised vehicles;
  - (3) has successfully completed a relevant driving training programme and demonstrated his or her competence in accordance with point (b);
  - (4) has demonstrated language proficiency in accordance with [point ADR.OPS.B.029](#), if that person intends to drive a vehicle on the manoeuvring area;
  - (5) has received training by its employer on the use of the vehicle intended to operate at the aerodrome.
- (b) The aerodrome operator shall establish and implement a driving training programme for drivers that operate on the apron or other operational areas, except the manoeuvring area, and for drivers that operate on the manoeuvring area. The training programme shall:
  - (1) be appropriate to the characteristics and operation of the aerodrome, the driver's functions and tasks to be performed, and the areas of the aerodrome that drivers may be authorised to operate;
  - (2) include:
    - (i) theoretical and practical training of adequate duration, at least in the following areas:
      - (A) regulatory framework and personal responsibilities;
      - (B) vehicle standards, aerodrome operational requirements and procedures;
      - (C) communications;
      - (D) radiotelephony, for drivers that operate in the manoeuvring area;
      - (E) human performance;
      - (F) familiarisation with the operating environment;
    - (ii) competence assessment of the drivers.
- (c) A driving authorisation issued in accordance with point (a) shall specify the parts of the movement area or other operational areas on which the driver is allowed to drive and shall remain valid as long as:



- (1) the requirements of points (a)(1) and (a)(2) are met;
- (2) the holder of the driving authorisation:
  - (i) undergoes and successfully completes training and proficiency checks in accordance with points [ADR.OR.D.017](#) (f) and (g);
  - (ii) if applicable, continues to demonstrate the required language proficiency in accordance with [point ADR.OPS.B.029](#).
- (d) Notwithstanding point (a), the aerodrome operator may permit a person to temporarily drive a vehicle on the movement area or other operational areas if:
  - (1) that person holds a valid driving licence, and any other licence required for the operation of specialised vehicles;
  - (2) that vehicle is escorted by a vehicle driven by a driver authorised in accordance with point (a).
- (e) The aerodrome operator shall:
  - (1) establish a system and implement procedures for:
    - (i) issuing driving authorisations and temporarily permitting the driving of vehicles;
    - (ii) ensuring that drivers to whom a driving authorisation has been issued, continue to comply with points (c)(1) and (c)(2);
    - (iii) monitoring the compliance of drivers with any driving requirements applicable at the aerodrome and for taking appropriate action, including the suspension and revocation of driving authorisations or permissions to temporarily drive a vehicle;
  - (2) maintain relevant records.

## GM1 ADR.OPS.B.024(a) Authorisation of vehicle drivers

ED Decision 2021/003/R

### DRIVING AUTHORISATION FOR THE MOVEMENT AREA AND OTHER OPERATIONAL AREAS

Depending on its design, the 'airside' part of an aerodrome may also encompass operational areas, other than the movement area, in which vehicles may also be operating for various purposes.

Example cases of such other operational areas, which are not part of the movement area, would be the service roads that may exist between the terminal buildings and aprons, perimeter roads used for various purposes, areas that are used for the parking of vehicles and ground support equipment, etc.

The driving in such other operational areas is also subject to the provisions of [ADR.OPS.B.024](#).

## GM1 ADR.OPS.B.024(a)(1) Authorisation of vehicle drivers

ED Decision 2021/003/R

### GENERAL

Driving authorisations are meant to be issued only to persons whose functions and tasks require the driving of a vehicle on the movement area or other operational areas of the aerodrome.

Driving authorisations cover all types of activities that involve driving in these areas, including but not limited to aerodrome operations and maintenance, groundhandling, security, aircraft maintenance,

etc. The identity of the organisation with which a driver is associated (e.g. private entity, State entity) is not considered relevant.

The number of persons authorised to drive on the manoeuvring area, and particularly on runways, needs to be limited to the minimum required in order to minimise the risk of runway incursions and should be reviewed periodically.

## **AMC1 ADR.OPS.B.024(a)(5) Authorisation of vehicle drivers**

*ED Decision 2021/003/R*

### **TRAINING OF DRIVERS ON THE USE OF VEHICLES**

- (a) A driver needs to receive specific training on the use of any vehicle or equipment, he or she will be using during his or her duties, e.g. special vehicle, tug, high loader, coach, etc. Upon completion of this training, the responsible organisation should provide the relevant records to the aerodrome operator.
- (b) If the driver is to be assigned a new vehicle type following the issuance of the authorisation, the process of point (a) should be repeated prior to allowing the driver to operate the new vehicle.

## **AMC1 ADR.OPS.B.024(b) Authorisation of vehicle drivers**

*ED Decision 2021/003/R*

### **TRAINING OF DRIVERS — GENERAL**

- (a) The training programme that drivers need to follow should depend on the areas where they need to be operating. The following two training programmes should be developed:
    - (1) General driving training programme

This training should cover the needs of all drivers operating on the apron area and other operational areas of the aerodrome. The successful completion of this training grants a driver the right to operate unescorted a vehicle on aprons and other operational areas of the aerodrome, except on the manoeuvring area.
    - (2) Manoeuvring area training programme

This training should cover the additional specific needs of the drivers who will be operating on the manoeuvring area. A driver is granted the right to operate unescorted on the manoeuvring area subject to the:
- (i) provisions of [ADR.OPS.B.024\(a\)\(4\)](#) and [AMC3 ADR.OPS.B.024\(b\)](#);
  - (ii) successful completion of the general driving training programme; and
  - (iii) successful completion of the manoeuvring area training programme.
- (b) Each of the above-mentioned training programmes (general driving training programme and manoeuvring area training programme) should consist of the following parts:
    - (1) Theoretical training

The theoretical training should be of a defined and adequate duration, supported by suitable educational means and material.

The theoretical training should be followed by an assessment of the trainees (see [AMC1 ADR.OR.D.017\(e\)](#)). Once the theoretical part has been successfully completed, the driver should undertake practical training.

(2) Practical training

During the phase of the practical training, which needs to be of a defined and adequate duration, the trainees should be provided with adequate practical training and familiarisation with the aerodrome facilities and its procedures by the nominated instructors, in day and, if relevant, night conditions.

Following the delivery of the practical training, the competence of the trainees should be assessed, in practical terms, by the nominated assessors (see [AMC1 ADR.OR.D.017\(e\)](#)). This assessment should aim at assessing the ability of the trainees to apply, in practice, the knowledge and skills they have acquired through the theoretical and practical training.

(3) Upon the successful completion of the practical training, and provided that the driver has received training on the use of a vehicle (see [AMC1 ADR.OPS.B.024\(a\)\(5\)](#)), a driving authorisation should be issued.

## GM1 ADR.OPS.B.024(b) Authorisation of vehicle drivers

*ED Decision 2021/003/R*

### TRAINING OF DRIVERS — GENERAL

The theoretical training is supported by material which provides up-to-date, adequate and suitable information regarding the aerodrome, in the form of presentations, maps, diagrams, videos, booklets, checklists, etc. as appropriate.

## AMC2 ADR.OPS.B.024(b) Authorisation of vehicle drivers

*ED Decision 2021/003/R*

### DRIVING TRAINING PROGRAMMES

(a) General driving training programme

- (1) The theoretical part of the general driving training programme should, as a minimum, cover the following areas:
  - (i) Driving authorisation framework, including:
    - (A) issuance, validity, conditions of use;
    - (B) control and audit of its issue;
    - (C) driving violations and enforcement procedures;
    - (D) relationship with the national driver licensing system;
    - (E) national requirements related to general vehicle driving licences;
    - (F) national Competent Authority guidance for movement area driving; and
    - (G) roles of various organisations:
      - (a) the role of the aerodrome operator in setting and maintaining standards;

- (b) the Competent Authority's role and its responsibilities;
  - (c) the role of the national and/or local police, and their involvement with airside driving; and
  - (d) the role of any other enforcement authorities dealing with vehicles, driving, health, and safety
- (ii) Personal responsibilities, including:
  - (A) requirements concerning fitness to drive (medical standards);
  - (B) use of personal protective equipment (e.g. high-visibility clothing and hearing protection);
  - (C) general driving standards;
  - (D) no-smoking; use of psychoactive substances and medicines, including requirements on alcohol consumption;
  - (E) implementation of 'sterile-cab' concept, by avoiding disturbing and distracting activities while driving;
  - (F) responsibilities with respect to FOD and fuel/oil spillage; and
  - (G) the responsibility to ensure that a vehicle is suitable for the task and is used correctly.
- (iii) Vehicle standards, including:
  - (A) condition and maintenance standards at the aerodrome and/or national level;
  - (B) the requirement to display obstruction lights and company insignia;
  - (C) the requirement for, and content of, daily vehicle inspections;
  - (D) vehicle fault reporting and rectification;
  - (E) requirements for the issue and display of vehicle authorisations;
  - (F) serviceability of all essential communication systems with air traffic services and base operations; and
  - (G) maintaining the vehicle's cabin free of loose and distracting articles/items, as per the 'sterile-cab' concept.
- (iv) Aerodrome rules and procedures, including:
  - (A) rules of the air, and air traffic services procedures applicable to aerodromes as they relate to vehicles, particularly rights of way;
  - (B) aerodrome regulations, procedures and instructions pertaining to vehicle operations;
  - (C) definition of movement areas, manoeuvring areas and aprons;
  - (D) methods used to disseminate general information and instructions to drivers;
  - (E) methods used to disseminate information regarding works in progress; and

- (F) reporting of occurrences the driver is involved in or witnesses.
- (v) General aerodrome layout, including:
  - (A) the general geography of the aerodrome;
  - (B) aviation terminology used such as runway, taxiway, apron, roads, crossings, runway-holding points;
  - (C) all aerodrome signs, markings and lighting for vehicles and aircraft, including their meaning;
  - (D) specific reference to signs, markings and lighting used to guard runways and critical areas; and
  - (E) specific reference to any controlled/uncontrolled taxiway crossing procedures.
- (vi) Hazards of general movement area driving, including:
  - (A) speed limits, prohibited areas, and no parking requirements;
  - (B) the danger zones around aircraft;
  - (C) engine suction/ingestion and blast, propellers, and helicopters;
  - (D) aircraft refuelling;
  - (E) FOD and spillages;
  - (F) vehicle reversing;
  - (G) staff and passengers walking across aprons;
  - (H) air bridges and other services such as fixed electrical ground power;
  - (I) the general aircraft turnaround process;
  - (J) aircraft emergency stop and fuel cut-off procedures;
  - (K) hazardous cargo;
  - (L) vehicle-towing requirements and procedures;
  - (M) driving at night; and
  - (N) driving in adverse weather conditions, particularly low visibility.
- (vii) Human performance, including:
  - (A) basic concepts of human factors;
  - (B) basic aviation psychology, including:
    - (a) attention and vigilance;
    - (b) perception;
    - (c) memory;
    - (d) human error;
    - (e) decision-making;
    - (f) avoiding and managing errors;

- (g) human behaviour; and
    - (h) human overload and underload.
  - (viii) Emergency procedures, including:
    - (A) actions and responsibilities in a crisis situation (any accident or serious incident occurring on the aerodrome);
    - (B) action in the event of a vehicle accident;
    - (C) specific action in the event of a vehicle striking an aircraft;
    - (D) action in the event of fire;
    - (E) action in the event of an aircraft accident/incident; and
    - (F) action in the event of personal injury.
  - (ix) Communications, including:
    - (A) radio procedures and phraseologies to be used (other than with air traffic services);
    - (B) light signals used by air traffic services;
    - (C) procedures to be used by vehicle drivers if lost or uncertain of their position;
    - (D) local emergency telephone numbers;
    - (E) how to contact the local aerodrome unit;
    - (F) portable radio, including:
      - (a) correct use of radios;
      - (b) effective range and battery life;
      - (c) screening/shielding effects on the aerodrome;
      - (d) use of correct call signs, as applicable; and
      - (e) safety while using radios, including procedures and instructions regarding the use of portable radios and hand-held microphones while driving a vehicle.
- (2) The practical part of the general driving training programme should, as a minimum, include the following visual familiarisation of the aerodrome:
  - (i) airside service roads, taxiway crossings, and any restrictions during low-visibility conditions;
  - (ii) aprons and stands;
  - (iii) surface paint markings for vehicles and aircraft;
  - (iv) surface paint markings that delineate the boundary between aprons and taxiways;
  - (v) signs, markings and lighting used on the taxiway that indicate the runways ahead;
  - (vi) parking areas and restrictions;
  - (vii) speed limits and regulations; and

- 
- (viii) hazards during aircraft turnarounds and aircraft movements
- (b) Manoeuvring area training programme
- (1) The theoretical part of the manoeuvring area training programme should, as a minimum, cover the following areas:
- (i) Air traffic services, including:
    - (A) the aerodrome's air traffic services function and area of responsibility;
    - (B) the ground movement control function and area of responsibility;
    - (C) normal and emergency procedures used by air traffic services relating to aircraft;
    - (D) normal handover/transfer points for vehicles;
    - (E) air traffic services call signs, vehicle call signs; and
    - (F) demarcation of responsibilities between air traffic services and apron management unit, if applicable.
  - (ii) Personal responsibilities, including:
    - (A) fitness to drive with particular emphasis on eyesight and colour perception;
    - (B) correct use of personal protective equipment;
    - (C) responsibilities with respect to FOD; and
    - (D) responsibilities with respect to escorting other vehicles on the manoeuvring area.
  - (iii) Vehicle standards, including:
    - (A) responsibility for ensuring the vehicle used is fit for the purpose and task and appropriately marked and lighted;
    - (B) requirements for daily inspection prior to operating on the manoeuvring area;
    - (C) particular attention to the display of obstruction and general lights; and
    - (D) serviceability of all essential communication systems with air traffic services and base operations.
  - (iv) Aerodrome layout, including:
    - (A) particular emphasis on signs, markings and lighting used on the manoeuvring area;
    - (B) special emphasis on signs, markings and lighting used to protect the runway;
    - (C) description of equipment essential to air navigation such as instrument landing systems (ILS);
    - (D) description of sensitive, critical or other protected zones areas related to ILS or other navigation aid antennae and the related markings and signs;
    - (E) description of ILS protected areas, and their relation to runway-holding points;

- (F) description of runway instrument/visual strip, cleared and graded area; and
- (G) description of lighting used on the manoeuvring area with particular emphasis on those related to low-visibility operations.
- (v) Hazards of manoeuvring area driving, including:
  - (A) engine suction/ingestion and blast, vortex, propellers, and helicopter operations;
  - (B) requirements and procedures for driving at night;
  - (C) requirements and procedures for operations in low visibility and other adverse weather conditions;
  - (D) right of way of vehicles, aircraft, towed aircraft, and rescue and firefighting vehicles in an emergency.
- (vi) Emergency procedures, including:
  - (A) actions to be taken in the event of a vehicle accident/incident on the manoeuvring area;
  - (B) actions to be taken in the event of an aircraft accident/incident on the manoeuvring area;
  - (C) actions to be taken if FOD or other debris is found on runways and taxiways; and
  - (D) local emergency telephone numbers.
- (vii) Communication procedures, including:
  - (A) air traffic services frequencies used and areas of applicability;
  - (B) language to be used when communicating with the air traffic services;
  - (C) procedure to be used by vehicle drivers if lost or uncertain of their position on the manoeuvring area;
  - (D) procedure for a vehicle breakdown on runways and taxiways and notifying the air traffic services unit of such events; and
  - (E) radio communication failure:
    - (a) procedure in the event of a radio communication or transponder or equivalent equipment failure while a vehicle is on the manoeuvring area; and
    - (b) procedures for light signals and other communication means that can be used by the air traffic services unit to pass instructions to a vehicle driver on the manoeuvring area.
- (viii) Aircraft familiarisation, including:
  - (A) knowledge of aircraft types and ability to identify all types normally operating at the aerodrome;
  - (B) knowledge of aircraft call signs; and



- (C) knowledge of aircraft terminology relating to engines, fuselage, control surfaces, undercarriage, lights, vents, etc.
- (2) The practical part of the manoeuvring area training programme should, as a minimum, include the following visual familiarisation of the aerodrome:
  - (i) all runways (including access and exit routes), holding areas, taxiways and aprons;
  - (ii) all signs, surface markings and lighting associated with runways, holding positions, CAT I, II, and III operations;
  - (iii) all signs, surface markings and lighting associated with taxiways;
  - (iv) specific markings that demarcate the boundary between aprons and manoeuvring areas;
  - (v) navigation aids such as ILS, sensitive, critical, or other protected areas, antennae, RVR equipment, and other meteorological equipment;
  - (vi) hazards of operating around aircraft landing, taking off or taxiing; and
  - (vii) any used naming convention for particular areas or routes.

### **AMC3 ADR.OPS.B.024(b) Authorisation of vehicle drivers**

*ED Decision 2021/003/R*

#### **RADIOTELEPHONY**

- (a) Any driver who will be operating on the manoeuvring area should undertake and complete a radiotelephony training, demonstrating both theoretical knowledge and practical competency in voice communication procedures.

- (b) Theoretical training

The theoretical training should emphasise on the following areas:

- (1) Categories of messages
  - Message categories and priorities; an understanding of distress, alerting, control and information messages.
- (2) Use of phonetic alphabet
  - Correct pronunciation and transmission of letters, words and numbers.
- (3) Use of standard phraseology
  - (i) emphasis on the need for drivers to use standard phraseology; and
  - (ii) the need for caution with certain phrases such as 'cleared' and 'go ahead'.
- (4) Use of call signs for aircraft, air traffic services, and vehicles
  - (i) understanding of terminology and acronyms used by air traffic services and pilots;
  - (ii) knowledge of the airline call signs used at the aerodrome; and
  - (iii) knowledge of the vehicle call signs used at the aerodrome.

(5) Read-back procedures

The need for vehicle drivers to use standard read back, in the same manner as pilots, for instructions such as ‘enter/cross the runway’, and if conditional clearances are used.

(6) Test procedures including readability scale

Understanding and use of the readability scale from 1 to 5.

(7) Transmitting techniques and use of radiotelephony

- (i) understanding the reasons for listening out prior to transmitting;
- (ii) use of standard phraseology and ICAO air-ground radiotelephony communication procedures;
- (iii) words and sounds to be avoided;
- (iv) correct positioning of microphones to avoid voice distortion;
- (v) avoidance of ‘clipped’ transmissions;
- (vi) awareness of regional accents and variations of speech; and
- (vii) speed of delivery of RTF phraseology.

(c) Practical training

In this phase, the training should cover the use of fixed and portable radio communication devices, and the practical use of the theoretical knowledge acquired in the previous phase of the training, through the implementation of the aerodrome’s communication procedures.

The practical training on radiotelephony may be provided in the course of an overall practical training, which involves the training on the use of vehicles or specialised vehicle/equipment associated with the driver’s task, or training on the operating procedures of the aerodrome, etc.

## GM2 ADR.OPS.B.024(b) Authorisation of vehicle drivers

*ED Decision 2021/003/R*

### RECURRENT, REFRESHER AND CONTINUATION TRAINING

[ADR.OR.D.017](#) point (f) regulates the provision of training following the completion of the initial training, as part of the aerodrome operator’s training programme. For the process that needs to be followed to ensure the continued competence of the personnel, see [ADR.OR.D.017\(f\)](#) and [AMC1 ADR.OR.D.017\(f\)](#).

## GM1 ADR.OPS.B.024(c) Authorisation of vehicle drivers

*ED Decision 2021/003/R*

### DRIVING AUTHRORISATION FORMAT

There are various solutions for issuing a driving authorisation. A combination of the driving authorisation with the badge issued to personnel or the issuance of a separate card are some of the possible solutions. In any case, it is important that the rights of the holder are clearly contained in the authorisation.

## AMC1 ADR.OPS.B.024(d) Authorisation of vehicle drivers

ED Decision 2021/003/R

### TEMPORARILY PERMITTING THE DRIVING OF VEHICLES

When permitting temporarily the driving of a vehicle, the period for which the permit is valid and the areas in which the driver will be allowed to operate under escort should be specified.

The escort of a vehicle whose driver has been issued a temporary driving permit should only be performed by the aerodrome operator directly or through a contracted organisation.

## GM1 ADR.OPS.B.024(d) Authorisation of vehicle drivers

ED Decision 2021/003/R

### TEMPORARILY PERMITTING THE DRIVING OF VEHICLES

ADR.OPS.B.024 in general addresses the case of authorisation of drivers whose nature of work and activities involves regular presence and driving within the aerodrome environment.

However, there are cases where it may be necessary to temporarily allow the driving of a vehicle on the movement area or other operational areas of the aerodrome for other reasons (e.g. a contractor's vehicle that needs to enter the movement area for maintenance activities taking place at the aerodrome, etc.).

In cases where the driving on the movement area or other operational areas is necessary but for a limited period of time, the aerodrome operator may permit such driving without requiring the driver to undergo the process for the issuance of an authorisation for the driving of this vehicle. It is expected, however, that before being permitted to operate in such areas, such drivers will be adequately briefed about their obligations while operating within the aerodrome perimeter, and that the aerodrome operator has developed procedures to be implemented during this type of operations.

In any case, the issuance of such a permit for such a driver does not waive the obligation of the aerodrome operator to ensure:

- the condition of the vehicle that this driver may be temporarily driving into the aerodrome area, in accordance with [ADR.OPS.B.026](#) (e)(2)(i);
- that this vehicle will in any case be escorted. For the characteristics of the vehicle that will be escorting that vehicle, see [ADR.OPS.B.026](#) (e)(2)(ii); and
- that the operation of this vehicle on the manoeuvring area is subject to the provisions of [ADR.OPS.B.026](#) (e)(2)(iii).

## AMC1 ADR.OPS.B.024(e) Authorisation of vehicle drivers

ED Decision 2021/003/R

### PROCEDURES FOR ISSUANCE OF DRIVING AUTHORISATIONS AND TEMPORARILY PERMITTING DRIVING OF VEHICLES, AND RELEVANT MONITORING ACTIVITIES

- (a) The aerodrome operator should clearly identify responsibilities for:
- (1) issuing driving authorisations and temporary driving permits;
  - (2) ensuring that the prerequisites for maintaining a driving authorisation valid continue to be met;

- (3) monitoring the compliance of the drivers with the driving rules applicable at the aerodrome, and taking appropriate action as the case may be. Such actions should include the possibility of suspension or revocation of the driving authorisation or of temporary driving permit.
- (b) Issuing such authorisations, temporarily permitting the driving of vehicles and ensuring that the prerequisites for maintaining a driving authorisation valid should be a controlled activity.
- (c) Irrespective of the organisational set-up chosen, it should be ensured that information regarding drivers who:
  - (1) do not continue to meet the requirements for maintaining the validity of the relevant driving authorisation; or
  - (2) violate the driving requirements,is forwarded to the aerodrome unit(s) responsible for the issuance/revocation of the driving authorisations, in a timely manner, to take appropriate action depending on the case.
- (d) The established procedures should clearly indicate how cases of violations of the applicable driving requirements at the aerodrome are dealt with. They should especially take into account the seriousness of each violation and also address cases of repeated violations of the applicable driving requirements. The cases where a driver should be required to undergo additional training should also be addressed in the procedures.

## ADR.OPS.B.026 Authorisation of vehicles

*Delegated Regulation (EU) 2020/2148*

- (a) The operation of a vehicle on the movement area or other operational areas shall require an authorisation issued by the aerodrome operator. The authorisation may be issued if the vehicle is used in activities related to the operation of the aerodrome and:
  - (1) is serviceable and fit for the intended operation;
  - (2) complies with the marking and lighting requirements of [point ADR.OPS.B.080](#);
  - (3) is equipped with a radio allowing two-way communication on the appropriate air traffic services frequency and any other frequency necessary, if it is intended to be operated on either of the following areas:
    - (i) the manoeuvring area;
    - (ii) other operational areas where communication with the air traffic services unit or other operational units of the aerodrome is necessary;
  - (4) is fitted with a transponder or other equipment that supports surveillance, if it is intended to be operated on the manoeuvring area, and the aerodrome is equipped with a surface movement guidance and control system whose operation requires the use of a transponder or other equipment supporting surveillance fitted on the vehicles.
- (b) The aerodrome operator shall limit the number of vehicles authorised to operate on the movement area and other operational areas to the minimum number required for the safe and efficient operation of the aerodrome.

- 
- (c) An authorisation issued in accordance with point (a) shall:
- (1) specify the parts of movement area or other operational areas where the vehicle may be operated;
  - (2) remain valid as long as the requirements of point (a) are met.
- (d) The aerodrome operator shall assign a call sign to a vehicle authorised in accordance with point (a) to operate at the aerodrome, if that vehicle is required to be radio-equipped. The call sign assigned to a vehicle shall:
- (1) not cause confusion regarding its identity;
  - (2) be appropriate to its function;
  - (3) for vehicles that operate in the manoeuvring area, be coordinated with the air traffic services unit, and disseminated to the relevant organisations at the aerodrome.
- (e) By derogation from point (a), the aerodrome operator may permit:
- (1) a vehicle authorised in accordance with points (a)(1) and (2), which is not equipped with a radio required under point (a)(3) and a transponder or other equipment supporting surveillance required under point (a)(4), to be occasionally operated in the areas referred to in points (a)(3) and (a)(4), provided that:
    - (i) that vehicle is escorted, at all times, by an authorised vehicle meeting the requirement of point (a)(3) and, if necessary, point (a)(4);
    - (ii) the escorting vehicle complies with the marking and lighting requirements of [point ADR.OPS.B.080](#);
    - (iii) low-visibility procedures are not in effect, if the escorted vehicle is to be operated in the manoeuvring area;
  - (2) the temporary entry of a vehicle to the aerodrome and its operation on the movement area or other operational areas, subject to the following conditions:
    - (a) a visual inspection of that vehicle determines that its condition does not endanger safety;
    - (b) that vehicle is escorted, at all times, by an authorised vehicle which:
      - (i) meets the requirement of point (a)(3) and, if necessary, point (a)(4), when operating in the areas referred to in points (a)(3) and (a)(4);
      - (ii) complies with the marking and lighting requirements of [point ADR.OPS.B.080](#);
    - (c) low-visibility procedures are not in effect, if the vehicle is to be operated in the manoeuvring area.
- (f) The aerodrome operator shall:
- (1) establish and implement procedures for:
    - (i) issuing vehicle authorisations and temporary permitting the entry to the aerodrome and operation of vehicles;
    - (ii) assigning call signs to vehicles;

- (iii) monitoring the compliance of vehicles with point ADR.OPS.B.026 and for taking appropriate action, including the suspension and revocation of vehicle authorisations or permissions to temporarily operate a vehicle;
- (2) maintain relevant records.

## AMC1 ADR.OPS.B.026(a)(1);(3) Authorisation of vehicles

*ED Decision 2021/003/R*

### EQUIPAGE OF VEHICLES — GENERAL

- (a) An updated copy of the movement area chart of sufficient size, including hot spots, as well the visual aids configuration on the aerodrome, and areas to be safeguarded, should be readily available in the driver's cabin of a vehicle intended to be operated in the manoeuvring area. If a vehicle is not to be operated in the manoeuvring area, the copy of the chart may be customised to provide only relevant information of the area in which the vehicle is to be operated, along with information of the adjacent areas, to improve the situational awareness of the driver.
- (b) The aerodrome operator, in coordination with the air traffic services provider and, if applicable, the apron management services provider, if different, should assess in which areas of the aerodrome, except the manoeuvring area, a vehicle needs to be equipped with a radio.

The radio with which the vehicle is equipped should allow two-way communication with the air traffic services unit frequency, but also any other unit that the driver of the vehicle may need to establish contact with.

Updated information regarding the frequencies of each unit should be readily available in the driver's cabin, as well as the frequencies that may need to be used at different areas of the aerodrome. Moreover, the call-sign of the vehicle should be available at a prominent place.

## GM1 ADR.OPS.B.026(b) Authorisation of vehicles

*ED Decision 2021/003/R*

### LIMITING THE NUMBER OF VEHICLES

The aerodrome operator limits vehicular activity to what is necessary, in order to ensure the safety of operations, but also taking into account the need to ensure the proper and smooth functioning of the aerodrome.

In this respect, vehicle use may be limited to those vehicles which are necessary to support the ground servicing and handling of aircraft cargo/mail and passengers, aerodrome maintenance and operations, including aerodrome emergency services, aerodrome security services, and State authorities vehicles.

Vehicles on the manoeuvring area should be limited to those absolutely necessary, especially on the runway. Vehicles allowed to operate on the runway should include only those necessary for operational activities such as inspections and maintenance, and emergency vehicles. It is strongly advised not to increase runway use by other vehicles such as those involved in ground operations, e.g. aircraft towing, etc. unless there is no alternative route.

## AMC1 ADR.OPS.B.026(c)(1) Authorisation of vehicles

ED Decision 2021/003/R

### GENERAL

A vehicle authorisation should be carried/displayed at a prominent place on the vehicle.

## GM1 ADR.OPS.B.026(c)(1) Authorisation of vehicles

ED Decision 2021/003/R

### GENERAL

Depending on the number of vehicles and the complexity of the aerodrome, the use of colour-coded vehicle authorisations is a solution that may be considered, to facilitate the control of the vehicles.

## GM1 ADR.OPS.B.026(d) Authorisation of vehicles

ED Decision 2021/003/R

### VEHICLE CALL SIGNS

The use of similar call signs may lead to call sign confusion, which is one of the factors associated with runway incursions.

To avoid call sign confusion, when assigning a call sign to a vehicle, careful consideration needs to be given to the call signs used by aircraft operating at the aerodrome, as well as the call signs of other vehicles.

Ways to reduce the possibility of call sign confusion include:

- (a) use of unique numbers or identification call signs for each vehicle; and
- (b) use of call signs which are appropriate to the function of the vehicle (e.g. 'Operations', 'Fire'). Where more than one vehicle is used in the same function, then a numbering policy may be used, such that the call sign is followed by a number, e.g. 'Operations 1'.

At aerodromes where the number of vehicles and the aircraft traffic is high, before assigning a call sign to a vehicle, it is recommended that the aerodrome operator, apart from the coordination with the air traffic services provider, consults also the other organisations operating vehicles at the aerodrome. As soon as a call sign is assigned to a vehicle, this needs to be known to at least the air traffic services provider.

## AMC1 ADR.OPS.B.026(e) Authorisation of vehicles

ED Decision 2021/003/R

### ESCORTING OF VEHICLES

The escorting of a vehicle should only be performed by the aerodrome operator directly or through a contracted organisation. The aerodrome operator should establish procedures for the escorting of vehicles, which as a minimum should contain:

- (a) under which minimum visibility conditions escorting of a vehicle may be performed on the manoeuvring area;
- (b) communication means and procedures between the escorting and the escorted vehicle(s);
- (c) escorting procedures when more than one vehicle is to be escorted; and

- (d) procedures for ensuring that drivers of the escorted vehicles comply with the instructions provided by the air traffic services unit.

The procedures should be coordinated with the air traffic services unit.

## GM1 ADR.OPS.B.026(e) Authorisation of vehicles

ED Decision 2021/003/R

### ESCORTING OF VEHICLES

- (a) Occasional operation of authorised vehicles without radio, transponder or other means supporting surveillance

The aerodrome operator may decide to permit the occasional operation of vehicles, which have been authorised to be operated on the aerodrome but which are not equipped with a radio, in areas where vehicles are required, by [ADR.OPS.B.026](#) (a)(3), to be equipped with a radio allowing two-way communication with the air traffic services or other aerodrome units, if necessary. The same applies with regard to authorised vehicles, which are not equipped with a transponder or other equipment supporting surveillance as foreseen in [ADR.OPS.B.026](#) (a)(4).

In this way, occasional unforeseen operational needs that may arise in the context of the operation of the aerodrome may be satisfied, given that such vehicles are not intended to be operated in such areas. However, if such need becomes more frequent, the aerodrome operator may need to consider the equipage of such vehicles with the necessary radio, transponder or other equipment supporting surveillance, considering, amongst others, the benefits that direct communication offers in terms of runway safety, as well as the fact that vehicle surveillance data facilitates the situational awareness of the air traffic services personnel.

- (b) Temporarily permitting vehicle operation

Vehicles used on the movement area and other operational areas of the aerodrome need to be authorised as per [ADR.OPS.B.026](#) (a). Vehicles may be authorised only if they are used in activities related to the operation of the aerodrome. However, from time to time, and for various reasons, it may be necessary to allow a vehicle to enter the aerodrome area and to be operated on the movement area or other operational areas, for a limited period of time (e.g. transportation of supplies, maintenance activities, transportation of patients, etc.). In such cases, the aerodrome operator may issue a temporary permit for the entry of the vehicle into the aerodrome and its operation in the area necessary.

In such situations, a visual inspection of the vehicle is necessary, for obvious damages or malfunctions of the vehicle (e.g. leakages, braking system, condition of tyres, lights, etc.) to determine the serviceability of the vehicle.

- (c) Characteristics of escorting vehicles

A vehicle mentioned in points (a) or (b) above, needs to be escorted by a vehicle equipped with a radio, in accordance with [ADR.OPS.B.026](#) (e)(1)(i) or [ADR.OPS.B.026](#) (e)(2)(b), if it is to be operated:

- (1) on the manoeuvring area; or
- (2) in other areas where vehicles are required to be equipped with a radio (see also point (b) of [AMC1 ADR.OPS.B.026\(a\)\(1\);\(3\)](#)).



In addition, if the escorted vehicle is to be operated on the manoeuvring area, the escorting vehicle would also need to be fitted with a transponder or other equipment supporting surveillance, if so required for the operation of the SMGCS of the aerodrome (see [ADR.OPS.B.026\(a\)\(4\)](#)).

Moreover, the escorting vehicle needs to meet at all times the respective marking and lighting requirements for the area(s) where the escorted vehicle will be operating (see [ADR.OPS.B.080](#)).

(d) Operational considerations

If the vehicle(s) mentioned in points (a) and (b) above is (are) intended to be operated on the manoeuvring area, care is taken to ensure that this is done in compliance with [ADR.OPS.B.026 \(e\)\(1\)\(iii\)](#) or [ADR.OPS.B.026 \(e\)\(2\)\(c\)](#), as the case may be, as well as the relevant procedures.

Particular attention needs to be paid to the cases where two or more vehicles are temporarily entering the aerodrome, and especially the manoeuvring area, forming a convoy. In such cases, the escorting vehicles are in positions that allow the monitoring of all escorted vehicles at all times, to ensure that all vehicles comply with the instructions of the air traffic services unit. In addition, attention is necessary to the way and means that the communication between the escorting and the escorted vehicle will be taking place.

In any case, temporarily permitting the use of the vehicle in accordance with [ADR.OPS.B.026 \(e\)\(2\)](#), or permitting the operation of an already authorised vehicle in accordance with [ADR.OPS.B.026 \(e\)\(1\)](#) does not waive the obligation of the aerodrome operator to ensure that the driver of the vehicle holds a permit to temporarily drive into the aerodrome area, or a driving authorisation as the case may be, in accordance with [ADR.OPS.B.024](#).

## AMC1 ADR.OPS.B.026(f) Authorisation of vehicles

ED Decision 2021/003/R

### PROCEDURES FOR ISSUANCE OF VEHICLE AUTHORISATIONS, TEMPORARILY PERMITTING THE OPERATION OF VEHICLES, ASSIGNING CALL SIGNS AND RELEVANT MONITORING ACTIVITIES

- (a) The procedures should clearly identify responsibilities for:
- (1) issuing vehicle authorisations, temporarily permitting the operation of a vehicle and assigning call signs to vehicles;
  - (2) ensuring that the prerequisites for maintaining a vehicle authorisation valid continue to be met; and
  - (3) monitoring the compliance of vehicles with the relevant requirements, and taking of appropriate action depending on the case. Such actions should include the possibility of suspension and revocation of a vehicle authorisation or a permission for the temporary operation of a vehicle.
- (b) Issuing vehicle authorisations, temporarily permitting the operation of vehicles and ensuring that the prerequisites for maintaining a vehicle authorisation valid should be a controlled activity.
- (c) Irrespective of the organisational set-up chosen to monitor the compliance of vehicles with the applicable requirements, a close cooperation should be established with the organisational unit(s):

- (1) responsible for the implementation of the maintenance programme of its own vehicles (see [ADR.OPS.C.007](#)); and
- (2) monitoring the implementation of the maintenance programme of the vehicles of organisations operating or providing services at the aerodrome.

It should be ensured that information regarding vehicles which do not continue to meet the relevant requirements is forwarded to the responsible aerodrome unit(s) (if different) to take appropriate action.

- (d) The established procedures should clearly indicate how cases of violations of the applicable requirements are dealt with, taking also into account the significance of each violation.

## ADR.OPS.B.027 Operation of vehicles

*Delegated Regulation (EU) 2020/2148*

- (a) The driver of a vehicle on the manoeuvring area shall operate the vehicle:
  - (1) only as authorised by the air traffic services unit, and in accordance with the instructions issued by that unit;
  - (2) in compliance with all mandatory instructions conveyed by markings and signs unless otherwise authorised by the air traffic services unit;
  - (3) in compliance with all mandatory instructions conveyed by lights.
- (b) The driver of a vehicle on the manoeuvring area shall operate the vehicle in accordance with the following rules:
  - (1) emergency vehicles that proceed to the assistance of an aircraft in distress shall be afforded priority over all other surface movement traffic;
  - (2) subject to the provisions of point (1):
    - (i) vehicles and vehicles towing aircraft shall give way to aircraft which are landing, taking off, or taxiing;
    - (ii) vehicles that do not tow aircraft shall give way to vehicles towing aircraft;
    - (iii) vehicles that do not tow aircraft shall give way to other vehicles that do not tow aircraft in accordance with the air traffic services unit instructions;
    - (iv) notwithstanding the provisions of points (i), (ii) and (iii), vehicles and vehicles towing aircraft shall comply with the instructions issued by the air traffic services unit.
- (c) The driver of a radio-equipped vehicle, intending to operate or operating on the manoeuvring area, shall:
  - (1) establish satisfactory two-way radio communication with the air traffic services unit on the appropriate air traffic services frequency before entering the manoeuvring area, and maintain a continuous listening watch on the assigned frequency;
  - (2) before entering the manoeuvring area, obtain authorisation from the air traffic services unit and shall operate only as authorised by the air traffic services unit. Notwithstanding such an authorisation, entry to a runway or runway strip or change in the operation

- authorised, shall be subject to a further specific authorisation by the air traffic services unit;
- (3) read back to the air traffic services personnel safety-related parts of the instructions which are transmitted by voice. Instructions to enter, hold short of, cross and operate on any runway, taxiway or runway strip shall always be read back;
  - (4) read back to the air traffic services personnel or acknowledge instructions other than in point (3) in a manner to clearly indicate that they have been understood and shall be complied with.
- (d) The driver of a vehicle that is operating in the manoeuvring area, when in doubt as to the position of the vehicle with respect to the manoeuvring area, shall:
- (1) notify the air traffic services unit of the circumstances, including the last known position;
  - (2) simultaneously, unless otherwise instructed by the air traffic services unit, vacate the runway, taxiway, or other part of the manoeuvring area, to a safe distance as expeditiously as possible;
  - (3) after actions referred to in points (1) and (2), stop the vehicle.
- (e) The driver of a vehicle on the manoeuvring area:
- (1) when operating a vehicle on a runway strip when that runway is used for landing or take-off, shall not approach the runway closer than the distance at which the runway-holding position or any road-holding positions have been established for that runway;
  - (2) when a runway is used for landing or take-off, shall not operate a vehicle on:
    - (i) the part of the runway strip extending beyond the runway ends of that runway;
    - (ii) the runway-end safety areas of that runway;
    - (iii) a clearway, if available, at a distance that would endanger an aircraft on the air.
- (f) The driver of a radio-equipped vehicle on the apron shall, if so required at the aerodrome:
- (1) establish satisfactory two-way radio communication with the responsible unit designated by the aerodrome operator before entering the apron;
  - (2) maintain a continuous listening watch on the assigned frequency.
- (g) The driver of a vehicle on the apron shall operate the vehicle in accordance with the following:
- (1) only as authorised by the responsible unit designated by the aerodrome operator, and in accordance with the instructions issued by that unit;
  - (2) in compliance with all mandatory instructions conveyed by markings and signs unless otherwise authorised by the responsible unit designated by the aerodrome operator;
  - (3) in compliance with all mandatory instructions conveyed by lights;
  - (4) give way to an emergency vehicle, an aircraft taxiing, about to taxi, or being pushed or towed;
  - (5) give way to other vehicles in accordance with local regulations;
  - (6) always give priority over emergency vehicles responding to an emergency.

- (h) The driver of a vehicle on the movement area and other operational areas shall:
- (1) operate the vehicle in accordance with the established speed limits and driving routes;
  - (2) not be engaged in disturbing or distracting activities while driving;
  - (3) comply with the communication requirements and the operational procedures contained in the aerodrome manual.
- (i) The driver of a vehicle escorting another vehicle shall ensure that the driver of the escorted vehicle operates the vehicle in accordance with the instructions given.
- (j) The driver of a vehicle shall park the vehicle only in areas designated by the aerodrome operator.
- (k) The aerodrome operator shall establish and implement procedures to ensure that drivers that operate on the movement area and other operational areas comply with points (a) to (j).

## GM1 ADR.OPS.B.027(e)(1) Operation of vehicles

*ED Decision 2021/003/R*

### OPERATION OF VEHICLES ON RUNWAY STRIPS, RESA AND CLEARWAYS

For the establishment of a runway-holding position or any road holding positions, see [CS ADR-DSN.D.340](#).

## AMC1 ADR.OPS.B.027(h)(2) Operation of vehicles

*ED Decision 2021/003/R*

### DISTURBING AND DISTRACTING ACTIVITIES WHILE DRIVING

When driving, a ‘sterile-cab concept’ should be implemented. In line with this, drivers should not be involved in non-essential activities that may affect their attention, situational awareness or judgement.

Such activities include but are not limited to the following:

- (a) texting with mobile phones or other devices;
- (b) making or answering phone calls;
- (c) listening to music or making use of media;
- (d) being involved in activities that require the lowering of the radio volume, if the vehicle is radio equipped; and
- (e) non-essential conversations with other persons that are in the driver’s cabin, or over the radio.

Moreover, the vehicle’s cabin should be kept free of loose and distracting articles/items.

## ADR.OPS.B.028 Aircraft towing

*Delegated Regulation (EU) 2020/2148*

The aerodrome operator shall:

- (a) establish aircraft manoeuvring procedures and designate routes to be used during aircraft towing operations on the movement area, to ensure safety;

- (b) ensure the provision of adequate and appropriate guidance during towing operations;
- (c) ensure that towed aircraft display lights during towing operations, in accordance with the provisions of point SERA.3215 of the Annex to [Commission Implementing Regulation \(EU\) No 923/2012](#)<sup>1</sup>;
- (d) establish and implement procedures to ensure adequate communication and coordination between the organisation executing the towing operation, the apron management services unit, and the air traffic services unit, as appropriate to the towing operation;
- (e) establish and implement procedures to ensure safety of towing operations in adverse weather or meteorological conditions, including by limiting or not permitting such operations.

## AMC1 ADR.OPS.B.028 Aircraft towing

*ED Decision 2021/003/R*

### AIRCRAFT TOWING PROCEDURES

- (a) The aerodrome operator should identify and designate the routes that may be used for towing operations, taking into account the aircraft characteristics and its compatibility with the design characteristics of the aerodrome and its operation.
- (b) The procedures should, as a minimum, cover the following:
  - (1) request for and authorisation of the towing operation;
  - (2) manoeuvring procedures, including turning direction(s), when exiting a stand, and limitations to aircraft types as applicable;
  - (3) measures to control other traffic on the apron area during the manoeuvring of the towed aircraft;
  - (4) coordination with the air traffic services unit and the apron management services unit, if different, taking into account their areas of responsibility;
  - (5) communication procedures to be applied during towing procedures;
  - (6) ensuring the display of lights of the aircraft to be towed, as per the requirements of SERA.3215;
  - (7) cases where guidance (e.g. marshaller and/or wing-walker) is needed in order to ensure aircraft clearance from obstacles;
  - (8) runway crossing, if applicable;
  - (9) cases where the use of a 'follow-me' service is required; and
  - (10) the safety measures to be taken to execute towing operation in adverse weather phenomena (slush, ice, etc.) or visibility conditions, and cases and conditions where such an operation is limited or not permitted.

<sup>1</sup> Commission Implementing Regulation (EU) No 923/2012 of 26 September 2012 laying down the common rules of the air and operational provisions regarding services and procedures in air navigation and amending Implementing Regulation (EU) No 1035/2011 and Regulations (EC) No 1265/2007, (EC) No 1794/2006, (EC) No 730/2006, (EC) No 1033/2006 and (EU) No 255/2010 ([OJ L 281, 13.10.2012](#), p. 1).

## GM1 ADR.OPS.B.028 Aircraft towing

ED Decision 2021/003/R

### TOWING ROUTES

An aerodrome operator may designate various routes for towing operations.

The way that these routes are used by the air traffic services provider, or other unit(s) responsible for parts of the aerodrome where the air traffic services provider is not responsible, depends on the operating and traffic conditions at an aerodrome.

In any case, irrespective of the actual route to be chosen at a given situation, the route needs to be suitable for the particular aircraft, as specified in [AMC1 ADR.OPS.B.028](#) point (a).

## ADR.OPS.B.029 Language proficiency

Delegated Regulation (EU) 2020/2148

- (a) A person required under point [ADR.OPS.B.024](#) to demonstrate language proficiency, shall demonstrate proficiency, at least at an operational level both in the use of phraseologies and in plain language, in accordance with point (b), in:
- (1) the English language; and
  - (2) any other language or languages used at the aerodrome for radio communication purposes with the air traffic services unit of the aerodrome.
- (b) The applicant shall demonstrate the ability to:
- (1) communicate effectively in voice-only and in face-to-face situations;
  - (2) communicate on common and work-related topics with accuracy and clarity;
  - (3) use appropriate communicative strategies to exchange messages and to recognise and resolve misunderstandings in a general or work-related context;
  - (4) handle successfully the linguistic challenges presented by a complication or unexpected turn of events which occurs within the context of a routine work situation or communicative task with which they are otherwise familiar;
  - (5) use a dialect or accent which is intelligible to the aeronautical community.
- (c) Language proficiency shall be demonstrated by a certificate issued by the organisation that conducted the assessment, attesting the language or languages, the level or levels of proficiency, and the date of the assessment.
- (d) Except for persons who have demonstrated language proficiency at an expert level, the language proficiency shall be re-assessed every:
- (1) four years from the date of the assessment, if the level demonstrated is operational level;
  - (2) six years from the date of the assessment, if the level demonstrated is extended level.
- (e) The demonstration of language proficiency shall be done through a method of assessment, which shall contain:
- (1) the process by which an assessment is done;
  - (2) the qualifications of the assessors conducting assessments of language proficiency;

- 
- (3) the appeal procedure.
- (f) The aerodrome operator shall make available language training to maintain the required level of language proficiency of its personnel.
- (g) By way of derogation from point (a), the Member State may decide that the English language proficiency may not be required for personnel referred to in point [ADR.OPS.B.024](#), for radio communication purposes with the air traffic services unit of the aerodrome. In such case, it shall perform a safety assessment covering one or several aerodromes.
- (h) The operator of the aerodrome may issue an authorisation to a person who has not demonstrated compliance with points (a) and (b) until:
- (1) 7 January 2026 as regards English language;
  - (2) 7 January 2023 as regards any language other than the English language.

## AMC1 ADR.OPS.B.029(b) Language proficiency

ED Decision 2021/003/R

### RATING SCALE

The following table describes the different levels of language proficiency:

LEVEL	PRONUNCIATION Assumes a dialect or accent intelligible to the aeronautical community	STRUCTURE Relevant grammatical structures and sentence patterns are determined by language functions appropriate to the task	VOCABULARY	FLUENCY	COMPREHENSION	INTERACTIONS
Expert (Level 6)	Pronunciation, stress, rhythm, and intonation, though possibly influenced by the first language or regional variation, almost never interfere with ease of understanding.	Both basic and complex grammatical structures and sentence patterns are consistently well controlled.	Vocabulary range and accuracy are sufficient to communicate effectively on a wide variety of familiar and unfamiliar topics. Vocabulary is idiomatic, nuanced and sensitive to register.	Able to speak at length with a natural, effortless flow. Varies speech flow for stylistic effect, for example to emphasise a point. Uses appropriate discourse markers and connectors spontaneously.	Comprehension is consistently accurate in nearly all contexts and includes comprehension of linguistic and cultural subtleties.	Interacts with ease in nearly all situations. Is sensitive to verbal and non-verbal cues, and responds to them appropriately.
Extended (Level 5)	Pronunciation, stress, rhythm, and intonation, though influenced by the first language or regional variation, rarely interfere	Basic grammatical structures and sentence patterns are consistently well controlled. Complex structures are attempted but with	Vocabulary range and accuracy are sufficient to communicate effectively on common, concrete, and work-related	Able to speak at length with relative ease on familiar topics, but may not vary speech flow as a stylistic device. Can make use of	Comprehension is accurate on common, concrete, and work-related topics and mostly accurate when the speaker is confronted with a	Responses are immediate, appropriate, and informative. Manages the speaker or



	with ease of understanding.	errors which sometimes interfere with meaning.	topics. Paraphrases consistently and successfully. Vocabulary is sometimes idiomatic.	appropriate discourse markers or connectors.	linguistic or situational complication or an unexpected turn of events. Is able to comprehend a range of speech varieties (dialect or accent) or registers.	listener relationship effectively.
<b>Operational (Level 4)</b>	Pronunciation, stress, rhythm, and intonation are influenced by the first language or regional variation but only sometimes interfere with ease of understanding.	Basic grammatical structures and sentence patterns are used creatively and are usually well controlled. Errors may occur, particularly in unusual or unexpected circumstances, but rarely interfere with meaning.	Vocabulary range and accuracy are usually sufficient to communicate effectively on common, concrete, and work-related topics. Can often paraphrase successfully when lacking vocabulary particularly in unusual or unexpected circumstances.	Produces stretches of language at an appropriate tempo. There may be occasional losses of fluency on transition from rehearsed or formulaic speech to spontaneous interaction, but this does not prevent effective communication. Can make limited use of discourse markers and connectors. Fillers are not distracting.	Comprehension is mostly accurate on common, concrete, and work-related topics when the accent or variety used is sufficiently intelligible for an international community of users. When the speaker is confronted with a linguistic or situational complication or an unexpected turn of events, comprehension may be slower or require clarification strategies.	Responses are usually immediate, appropriate, and informative. Initiates and maintains exchanges even when dealing with an unexpected turn of events. Deals adequately with apparent misunderstandings by checking, confirming, or clarifying.
<b>Pre-operational (Level 3)</b>	Pronunciation, stress, rhythm, and intonation	Basic grammatical structures and	Vocabulary range and accuracy are often	Produces stretches of language, but	Comprehension is often accurate on	Responses are sometimes

	are influenced by the first language or regional variation and frequently interfere with ease of understanding.	sentence patterns associated with predictable situations are not always well controlled. Errors frequently interfere with meaning.	sufficient to communicate effectively on common, concrete, and work-related topics but range is limited and the word choice often inappropriate. Is often unable to paraphrase successfully when lacking vocabulary.	phrasing and pausing are often inappropriate. Hesitations or slowness in language processing may prevent effective communication. Fillers are sometimes distracting.	common, concrete, and work-related topics when the accent or variety used is sufficiently intelligible for an international community of users. May fall to understand a linguistic or situational complication or an unexpected turn of events.	immediate, appropriate, and informative. Can initiate and maintain exchanges with reasonable ease on familiar topics and in predictable situations. Generally inadequate when dealing with an unexpected turn of events.
<b>Elementary (Level 2)</b>	Pronunciation, stress, rhythm, and intonation are heavily influenced by the first language or regional variation and usually interfere with ease of understanding.	Shows only limited control of few simple memorised grammatical structures and sentence patterns.	Limited vocabulary range consisting only of isolated words and memorised phrases.	Can produce very short, isolated, memorised utterances with frequent pausing and a distracting use of fillers to search for expressions and articulate less familiar words.	Comprehension is limited to isolated, memorised phrases when they are carefully and slowly articulated.	Response time is slow, and often inappropriate. Interaction is limited to simple routine exchanges.
<b>Pre-Elementary (Level 1)</b>	Performs at a level below the elementary level.	Performs at a level below the elementary level.	Performs at a level below the elementary level.	Performs at a level below the elementary level.	Performs at a level below the elementary level.	Performs at a level below the elementary level.

Note: Operational level (Level 4) is the minimum required proficiency level for radiotelephony communication.

Levels 1 through 3 describe pre-elementary, elementary and pre-operational levels of language proficiency respectively, all of which describe a level below the language proficiency requirement.

Levels 5 and 6 describe extended and expert levels at levels of proficiency more advanced than the minimum required standard.

## AMC1 ADR.OPS.B.029(e) Language proficiency

*ED Decision 2021/003/R*

### GENERAL

- (a) The language competence assessment should be designed to reflect a range of tasks undertaken by vehicle drivers but with special focus on the knowledge of the language rather than knowledge of the operational procedures.
- (b) The assessment should determine the applicant's ability to:
  - (1) communicate effectively using standard radiotelephony phraseology;
  - (2) deliver and understand messages in plain language in both usual and unusual situations that necessitate departure from standard radiotelephony phraseology; and
  - (3) deal with an unexpected turn of events and solve apparent misunderstandings.

## AMC2 ADR.OPS.B.029(e) Language proficiency

*ED Decision 2021/003/R*

### ASSESSMENT

- (a) The assessment should comprise the following three elements:
  - (1) listening: assessment of comprehension;
  - (2) speaking: assessment of pronunciation, fluency, structure and vocabulary; and
  - (3) interaction.
- (b) The switch between phraseology and plain language should be assessed in relation to listening and speaking proficiency.
- (c) When the assessment is not conducted in a face-to-face situation, appropriate technologies should be used for the assessment of the person's abilities to listen and speak, and to enable interactions.
- (d) The assessment may also be conducted during training activities or during proficiency checks, with prior notification given to the person concerned.
- (e) The assessment should be conducted using the rating scale in [AMC1 ADR.OPS.B.029\(b\)](#).

## AMC3 ADR.OPS.B.029(e) Language proficiency

*ED Decision 2021/003/R*

### LANGUAGE PROFICIENCY ASSESSORS

- (a) Persons responsible for language competency assessment ('assessors') should be suitably trained, including in the requirements specific to the language proficiency assessment, and qualified. They should be either aviation specialists or language specialists with additional aviation-related training.
- (b) Language proficiency assessors should undergo regular refresher training on language assessment skills.

- (c) The assessors should not conduct language proficiency assessments of persons to whom they have provided language training, or whenever, for any other reason, their objectivity may be affected.

## AMC4 ADR.OPS.B.029(e) Language proficiency

ED Decision 2021/003/R

### CRITERIA FOR THE ACCEPTABILITY OF LANGUAGE ASSESSMENT ORGANISATIONS

- (a) If the language assessment organisation also provides language training, there should be a clear and documented separation between the two activities.
- (b) The language assessment organisation should employ a sufficient number of qualified interlocutors and language proficiency assessors to administer the tests.
- (c) The assessment documentation should include at least the following:
- (1) assessment objectives;
  - (2) assessment layout, timescale, technologies used, assessment samples, voice samples;
  - (3) assessment criteria and standards (at least for the operational, extended and expert level of the rating scale mentioned in [AMC1 ADR.OPS.B.029\(b\)](#));
  - (4) documentation demonstrating the assessment validity, relevance and reliability for the operational, extended and expert level;
  - (5) procedures to ensure that language assessments are standardised within the organisation and across the aerodrome organisations;
  - (6) assessment procedures and responsibilities:
    - (i) preparation of individual assessment;
    - (ii) administration: location(s), identity check and invigilation, assessment discipline, confidentiality/security;
    - (iii) reporting and documentation provided to the aerodrome operator or to the applicant, including sample certificate; and
    - (iv) retention of documents and records.
- (d) The assessment documentation and records should be kept for a period of time determined by the Competent Authority and made available to the Competent Authority upon request.

## GM1 ADR.OPS.B.029(e) Language proficiency

ED Decision 2021/003/R

### LANGUAGE PROFICIENCY ASSESSMENT

The aim of the assessment is to determine the ability of a person to speak and understand the language(s) used for radiotelephony communications.

- (a) The assessment includes:
- (1) voice-only or face-to-face situations;
  - (2) common, concrete and work-related topics for vehicle drivers.

- 
- (b) The assessment determines the applicant's speaking and listening abilities. A mere assessment of the grammatical knowledge, reading and writing is not appropriate.
- (c) The assessment determines the language skills of the applicant in the following areas:
- (1) pronunciation:
    - (i) the extent to which the pronunciation, stress, rhythm and intonation are influenced by the applicant's first language or national variations;
    - (ii) how much they interfere with ease of understanding.
  - (2) structure:
    - (i) the ability of the applicant to use both basic and complex grammatical structures;
    - (ii) the extent to which the applicant's errors interfere with the meaning.
  - (3) vocabulary:
    - (i) the range and accuracy of the vocabulary used;
    - (ii) the ability of the applicant to paraphrase successfully when lacking vocabulary.
  - (4) fluency:
    - (i) tempo;
    - (ii) hesitancy;
    - (iii) rehearsed versus spontaneous speech;
    - (iv) use of discourse markers and connectors.
  - (5) comprehension:
    - (i) on common, concrete and work-related topics;
    - (ii) when confronted with a linguistic or situational complication or an unexpected turn of events.
  - (6) interactions:
    - (i) quality of response (immediate, appropriate, and informative);
    - (ii) the ability to initiate and maintain exchanges:
      - (A) on common, concrete and work-related topics;
      - (B) when dealing with an unexpected turn of events;
    - (iii) the ability to deal with apparent misunderstandings by checking, confirming or clarifying.

The accent or variety of accents used in the test material should be sufficiently intelligible for an international community of users.

## GM2 ADR.OPS.B.029(e) Language proficiency

ED Decision 2021/003/R

### LANGUAGE PROFICIENCY ASSESSORS

- (a) The preferred approach for an assessment would be to form an assessment team consisting of an operational expert and a language expert.
- (b) The language proficiency assessors need to be trained in the requirements specific to the language proficiency assessment, and assessment and interlocution techniques.

## GM3 ADR.OPS.B.029(e) Language proficiency

ED Decision 2021/003/R

Further guidance on the assessment of language proficiency may be found in ICAO Doc 9835 'Manual on the Implementation of ICAO Language Proficiency Requirements'.

## AMC1 ADR.OPS.B.029(f) Language proficiency

ED Decision 2021/003/R

### LANGUAGE TRAINING

- (a) Language training should contain communication in a job-related context particularly to handle abnormal and emergency situations and conduct non-routine coordination with air traffic controllers, colleagues and other technical staff.
- (b) Emphasis should be placed on listening comprehension, speaking interaction and vocabulary building.

## GM1 ADR.OPS.B.029(f) Language proficiency

ED Decision 2021/003/R

### LANGUAGE TRAINING

A purely routine use of the language through phraseology, standard procedures and limited social contact only maintains a restricted core usage of the language which might be inadequate for managing unexpected and abnormal situations.

Language proficiency erosion (language attrition) occurs rapidly over time; the lower the initial level, the faster the rate of erosion unless systematic strategies and a high degree of motivation counteract this trend.

It is documented that one's language and communicative proficiency, even in one's native language, deteriorates sharply under stress; therefore, participation in available language training is recommended.

## AMC1 ADR.OPS.B.029(g) Language proficiency

ED Decision 2021/003/R

### SAFETY ASSESSMENT WHEN PROFFICIENCY IN THE ENGLISH LANGUAGE IS NOT DEMONSTRATED

The safety assessment required by point (g) of [ADR.OPS.B.029](#) should be conducted prior to the issuance of a formal decision of a Member State not to require the demonstration of language proficiency in the English language by vehicle drivers.

The safety assessment of the impact of not demonstrating language proficiency in the English language should be conducted in an independent, impartial and comprehensive manner and should, in particular, take into account the following:

- (a) the opinion of the competent authorities for aerodromes and the air navigation services providers in the Member State, including results of relevant oversight activities, for each aerodrome concerned;
- (b) the opinion of the aerodrome operators and the air navigation services providers concerned, including the results of relevant safety assessments conducted by the organisations concerned in the context of their management systems with regard to runway incursion prevention;
- (c) the opinion of the local runway safety team established at each aerodrome;
- (d) the aerodrome design, and operating conditions of each aerodrome concerned, including the number of frequencies used in the manoeuvring area;
- (e) the traffic structure (national, international) of each individual aerodrome, including seasonal traffic peaks;
- (f) any relevant occurrence reports, at least at EU level. For this purpose, the European Central Repository referred to in Article 8 of [Regulation \(EU\) No 376/2014](#) should also be consulted; and

The assessment should be made publicly available and should be reviewed regularly.

## **ADR.OPS.B.030 Surface movement guidance and control system**

*Delegated Regulation (EU) 2020/2148*

- (a) The aerodrome operator shall ensure that a surface movement guidance and control system is provided at the aerodrome.
- (b) As part of the surface movement guidance and control system, the aerodrome operator shall, in coordination with the air traffic services provider, assess the need to establish standard routes for taxiing aircraft on the aerodrome. Where standard routes are provided, the aerodrome operator shall:
  - (1) ensure that they are adequate and suitable for the aerodrome traffic, design and intended operations, and properly identified;
  - (2) provide relevant information to the aeronautical information services provider for publication in the AIP.
- (c) Where the operation of the surface movement guidance and control system requires the use of a transponder by aircraft on the movement area, the aerodrome operator shall coordinate with the air navigation services provider:
  - (1) the relevant transponder operating procedures to be complied with by aircraft operators;
  - (2) the provision of the relevant information to the aeronautical information services provider for publication in the AIP.



## AMC1 ADR.OPS.B.030 Surface movement guidance and control system

*ED Decision 2014/012/R*

### GENERAL

- (a) A surface movement guidance and control system should take into account:
  - (1) the density of air traffic;
  - (2) the visibility conditions under which operations are intended;
  - (3) the need for pilot orientation;
  - (4) the complexity of the aerodrome layout; and
  - (5) movements of vehicles.
- (b) The surface movement guidance and control system should be designed to assist in the prevention of inadvertent incursions of aircraft and vehicles onto an active runway;
- (c) The system should be designed to assist in the prevention of collisions between aircraft, and between aircraft and vehicles or objects, on any part of the movement area.
- (d) Where a surface movement guidance and control system is provided by selective switching of stop bars and taxiway centre line lights, the following requirements should be met:
  - (1) taxiway routes which are indicated by illuminated taxiway centre line lights should be capable of being terminated by an illuminated stop bar;
  - (2) the control circuits should be so arranged that when a stop bar located ahead of an aircraft is illuminated, the appropriate section of taxiway centre line lights beyond it is suppressed; and
  - (3) the taxiway centre line lights are activated ahead of an aircraft when the stop bar is suppressed.
- (e) The aerodrome operator should develop the surface movement guidance and control system (SMGCS) procedures in cooperation with the aerodrome air traffic services provider.

## GM1 ADR.OPS.B.030 Surface movement guidance and control system

*ED Decision 2014/012/R*

### GENERAL

- (a) The SMGCS system should comprise an appropriate combination of visual aids, non-visual aids, procedures, control, regulation, management and information facilities. Systems range from the very simple at small aerodromes, with light traffic operating in good visibility conditions, to the complex systems necessary at large aerodromes with heavy traffic operating in low visibility conditions. The system selected for an aerodrome will be appropriate to the operational environment in which that aerodrome will operate.
- (b) Surface movement radar for the manoeuvring area could be provided at an aerodrome intended for use in runway visual range conditions less than a value of 350 m.

- (c) Surface movement radar for the manoeuvring area could be provided at an aerodrome other than that in (b) above when traffic density and operating conditions are such that regularity of traffic flow cannot be maintained by alternative procedures and facilities.

## AMC1 ADR.OPS.B.030(b) Surface movement guidance and control system

*ED Decision 2021/003/R*

### STANDARD TAXI ROUTES

- (a) Where established, such routes should:
- (1) cover aircraft taxiing between runways, aprons, and maintenance areas (if available);
  - (2) be direct, simple and, where practicable, designed to avoid conflicts with the routes of other aircraft or vehicles and capable of being used in all weather conditions;
  - (3) be identified by designators distinctively different from those of the runways and air traffic services routes; and
  - (4) be adequate and suitable for the largest aircraft likely to use them, taking as a minimum into account its interaction with the aerodrome facilities, navigation aids, aerodrome surfaces, jet blast effects, and the operation of other aircraft.
- (b) Where standard taxi routes are provided, details of such routes should be published in the AIP and shown on aerodrome charts, or ground movement chart, depending on the complexity of the movement area, available aids and facilities.

Where a route includes taxiing between different areas of responsibility, (e.g. areas under control of air traffic services and the apron management services), the transition points should be indicated on either the aerodrome chart or ground movement chart.

## GM1 ADR.OPS.B.030(b) Surface movement guidance and control system

*ED Decision 2021/003/R*

### STANDARD TAXI ROUTES

Standard taxi routes may be provided in order to maintain or increase safety, regularity, and efficiency of operations especially in low-visibility conditions or high traffic, by minimising the amount of control intervention and the consequent volume of radiotelephony communications and workload.

However, as not all aerodromes:

- (a) serve the same level of traffic or have the same traffic density;
- (b) are operated in the same pattern, or under the same visibility conditions;
- (c) have the same size, design and complexity,

the aerodrome operator needs to assess, in coordination with the air traffic services provider, the need to establish standard taxi routes. In this process, the views of the aerodrome users may also be sought, through the aerodrome's local runway safety team.

Further guidance for the development of standard taxi routes may be found in Chapters 3 and 6 of ICAO Doc 9476 'Manual of Surface Movement Guidance and Control Systems (SMGCS)'.

## AMC1 ADR.OPS.B.030(c) Surface movement guidance and control system

*ED Decision 2021/003/R*

### USE OF AIRCRAFT TRANSPONDER

The transponder operating procedures and the relevant information that need to be sent to the aeronautical information services provider for publication in the AIP should include:

- the phases and areas of the aerodrome at which the transponder needs to be used when an aircraft is on the movement area of the aerodrome; and
- measures to prevent causing false ACAS II Resolution Advisories to airborne aircraft in the vicinity of the aerodrome.

Such information should be published in the local aerodrome regulations in the AIP, following coordination with the Competent Authority. Until the publication of the information in the AIP, the aerodrome operator may additionally request the broadcast of relevant information via the local automated terminal information service (ATIS).

## ADR.OPS.B.031 Communications

*Delegated Regulation (EU) 2020/2148*

- (a) Vehicles and the air traffic services unit shall communicate in accordance with the applicable requirements of Section 14 of the Annex to [Implementing Regulation \(EU\) No 923/2012](#).
- (b) The aerodrome operator shall, in coordination with the air traffic services provider, establish communication procedures, including:
  - (1) the frequencies and the language or languages to be used for communication between the air traffic services unit and vehicles that intend to operate or are operating on the manoeuvring area;
  - (2) communication between the air traffic services unit and pedestrians that intend to operate or are operating on the manoeuvring area;
  - (3) dissemination of significant aerodrome-related information that may affect the safety of operations on the manoeuvring area, using radio communications;
  - (4) signals and other communication means, to be used, in all visibility conditions, in the case of radio communication failure between the air traffic services unit and vehicles or pedestrians on the manoeuvring area.

## GM1 ADR.OPS.B.031(b) Communications

*ED Decision 2021/003/R*

### SITUATIONAL AWARENESS

Improving the situational awareness of vehicle drivers operating on the manoeuvring area is important, as it may also affect the situational awareness and decision-making of the air traffic services personnel and flight crews. Situational awareness is improved by conducting communications in a common frequency and language, whenever this is possible.

## AMC1 ADR.OPS.B.031(b)(4) Communications

*ED Decision 2021/003/R*

### RADIO COMMUNICATION FAILURE

- (a) The signals to be used in case of radio communication failure between air traffic services and vehicles or pedestrians authorised to operate on the manoeuvring area should have the following meaning:

LIGHTS SIGNAL FROM AIR TRAFFIC SERVICES	MEANING
Green flashes	Permission to cross landing area or to move onto taxiway
Steady red	Stop
Red flashes	Move off the landing area or taxiway and watch out for aircraft
White flashes	Vacate manoeuvring area in accordance with local instructions

- (b) In emergency conditions or if the signals in point (a) are not observed, the signal given below will be used for runways or taxiways equipped with a lighting system and should have the following meaning:

LIGHT SIGNAL	MEANING
Flashing runway or taxiway lights	Vacate the runway and observe the tower for light signal

- (c) Care should be taken to ensure that the procedures address the case where, due to the prevailing visibility conditions, the light signals may not be seen by the driver or the pedestrian authorised to operate on the manoeuvring area.
- (d) In case of agreement with the air traffic services provider to use other/additional communication means in the event of radio communication failure (e.g. mobile phones), the procedures should also cover the necessary practical details (e.g. telephone numbers to be used), as well as the order of the use of the agreed solutions.

## ADR.OPS.B.033 Control of pedestrians

*Delegated Regulation (EU) 2020/2148*

- (a) The aerodrome operator shall establish and implement procedures to:
- (1) limit the access to the movement area and other operational areas only to persons whose duties require them to have access to such areas;
  - (2) ensure that such persons are allowed unescorted access to such areas only if they have received relevant training and demonstrated their competence;
  - (3) control the movement of persons on the apron, and ensure that passengers embarking or disembarking an aircraft or who need to walk to, from or across the apron:
    - (i) are escorted by trained and competent personnel;

- (ii) do not interfere with stationary aircraft and ground servicing activities;
  - (iii) are protected from operating aircraft, including the effects of their engines, as well as vehicular or other activities.
- (b) The aerodrome operator shall establish and implement procedures to ensure:
- (1) the orderly and safe entry and operation in the manoeuvring area of personnel whose tasks involve access to this area without a vehicle;
  - (2) that such personnel:
    - (i) are properly equipped, including with high-visibility clothing, orientation means, and means allowing two-way communication with the air traffic services unit and the respective unit of the aerodrome operator during such operations;
    - (ii) obtain authorisation from the air traffic services unit before entering the manoeuvring area. Notwithstanding such an authorisation, entry to a runway or runway strip or change in the operation authorised shall be subject to a further specific authorisation by the air traffic services unit;
    - (iii) do not enter the manoeuvring area when low-visibility procedures are in effect.

## AMC1 ADR.OPS.B.033(a) Control of pedestrians

*ED Decision 2021/003/R*

### GENERAL

- (a) The procedures to prevent unauthorised access to the movement area and other operational areas of the aerodrome of persons who are not allowed to have access to such areas should be coordinated with the appropriate authority responsible for security.
- (b) In case passengers are embarking/disembarking on the apron, or if no transportation means is used for their transfer to/from the terminal building or from one stand to the other, then, apart from the need to ensure that passengers are always escorted, the procedures should, amongst others, include measures to ensure that:
- (1) passengers do not pass under aircraft wings or beneath fuel vents, or close to the propellers or rotors of the aircraft they are boarding/disembarking or those of aircraft on adjacent stands;
  - (2) passengers remain clear of vehicular traffic around the aircraft, electrical cables, fuel hoses and other equipment;
  - (3) passengers use predetermined routes while moving from/to or across the apron; and
  - (4) passengers and any other persons on the apron are protected from the effects of engine jet-blast or downwash during their presence on the apron, including by restricting aircraft engine use.

Depending on the configuration of the apron, physical moveable barriers may also be used to indicate the desired route to follow and facilitate the control and movement of passengers on the apron. When not in use, such equipment should be properly stowed to ensure that it does not become a source of FOD.

## AMC1 ADR.OPS.B.033(b) Control of pedestrians

ED Decision 2021/003/R

### PERSONNEL OPERATING ON THE MANOEUVRING AREA

- (a) Personnel allowed access to the manoeuvring area without the use of a vehicle should be equipped at least with personal protective equipment, suitable charts of the aerodrome, a radio for two-way communication on the appropriate air traffic services frequency (and other means of communication as per the radio-communication failure procedure — see [AMC1 ADR.OPS.B.031\(b\)\(4\)](#)) with the air traffic services unit, and other appropriate means to conduct their duties suitable to the situation and local conditions.
- (b) The procedures should, as a minimum, provide information as to:
  - (1) which personnel can enter the manoeuvring area and for which purposes;
  - (2) the points from which entry to the manoeuvring area can take place;
  - (3) the hours and minimum visibility conditions that such an entry is allowed;
  - (4) communication with the air traffic services unit prior to entering the manoeuvring area and afterwards;
  - (5) communication with the respective unit of the aerodrome operator;
  - (6) actions to be taken in the event of radio communication failure (see [AMC1 ADR.OPS.B.031\(b\)\(4\)](#)); and
  - (7) right of way between vehicles, pedestrians and aircraft.
- (c) The procedures should be coordinated with the air traffic services unit.

## ADR.OPS.B.035 Operations in winter conditions

Regulation (EU) No 139/2014

The aerodrome operator shall ensure that means and procedures are established and implemented for providing safe conditions for aerodrome operations during winter conditions.

*[applicable until 11 August 2021]*

## ADR.OPS.B.035 Operations in winter conditions

Delegated Regulation (EU) 2020/2148

- (a) The aerodrome operator shall, when the aerodrome is expected to operate in conditions when snow, slush or ice may accumulate on the movement area, develop and implement a snow plan. As part of the snow plan, the aerodrome operator shall:
  - (1) have provisions for the use of materials to remove or to prevent the formation of ice and frost or to improve runway surface friction characteristics;
  - (2) ensure, as far as reasonably practical, the removal of snow, slush or ice from the runways in use and the other parts of the movement area which are intended to be used for the operation of aircraft.
- (b) The aerodrome operator shall provide for publication in the AIP information regarding:
  - (1) the availability of equipment for snow removal and snow and ice control operations;

- (2) approval status, if applicable, regarding the use of specially prepared winter runways;
- (3) the type of materials in use for movement area surface treatment.

*[applicable from 12 August 2021]*

## AMC1 ADR.OPS.B.035 Operations in winter conditions

*ED Decision 2014/012/R*

### GENERAL

- (a) The aerodrome operator should prepare, in collaboration with air traffic services provider and other relevant parties, procedures for winter maintenance (snow plan). The procedures should include requirements for inspections, criteria for snow-clearing, priorities for snow-clearing, criteria for preparation of operational surfaces, requirements for marking of snow-covered operational surfaces, and methods for assessing and reporting the surface conditions. The criteria specified in the winter maintenance procedures should be minimum criteria for maintaining safe aerodrome operations, including criteria for suspension of runway operation.
- (b) The aerodrome operator should ensure that snow, slush, ice, standing water, and other contaminants are removed from the surface of a paved runway, as rapidly and completely as possible, to minimise accumulation.
- (c) The aerodrome operator should, as adequate, avoid harmful effects on environment, aircraft or pavements when using chemicals to remove snow, slush, ice, and other contaminants from operational surfaces.

*[AMC1 ADR.OPS.B.035 applicable until 11 August 2021 — ED Decision 2021/003/R]*

## GM1 ADR.OPS.B.035 Operations in winter conditions

*ED Decision 2014/012/R*

### AERODROME SNOW PLAN

- (a) The aerodrome snow plan should be published and made available to all concerned in snow clearance.
- (b) Details of the equipment available at the aerodrome should be published in the Aeronautical Information Publication (AIP).
- (c) The aerodrome snow plan should include the following:
  - (1) the Snow Committee members and the person in charge of the snow clearance operation, with a chain of command giving a breakdown in duties;
  - (2) methods of communication between aerodrome operations, air traffic control, and the Meteorological Office;
  - (3) the equipment available for snow clearance. This should include equipment for ploughing, sweeping, and blowing snow;
  - (4) priority of surfaces to be cleared, and clearance limits for aircraft using the aerodrome;
  - (5) collection of information for SNOWTAM and dissemination of this information;
  - (6) designated snow dumping or melting areas to avoid confusion during the actual clearance operations;

- (7) an alerting system in order that sufficient warning is given to all bodies concerned;
- (8) the manpower available, including staff for equipment maintenance arrangements for shifts, and call out procedures;
- (9) deployment of equipment and tactical approaches to be used;
- (10) general principles to be followed in deciding when to close runways for snow clearance and designation of management personnel authorised to make the decision;
- (11) methods of assessing and reporting the surface conditions; and
- (12) criteria for the suspension of runway operations.

[GM1 ADR.OPS.B.035 applicable until 11 August 2021 — ED Decision 2021/003/R]

## AMC1 ADR.OPS.B.035(a) Operations in winter conditions

ED Decision 2021/003/R

### AERODROME SNOW PLAN

The aerodrome snow plan should reflect the exposure of the aerodrome to winter conditions and should include the following:

- (a) the Snow Committee members and the person in charge of the winter operation, with a chain of command giving a breakdown in duties;
- (b) methods of communication between aerodrome operations, air traffic services, and the MET provider;
- (c) the equipment available for snow clearance and surface treatment. This should include equipment for ploughing, sweeping, and blowing snow and application of materials;
- (d) priority of surfaces to be cleared, and clearance limits for aircraft using the aerodrome;
- (e) collection of information for RCR and dissemination of this information;
- (f) designated snow dumping or melting areas;
- (g) an alerting system in order that sufficient warning is given to all bodies concerned;
- (h) the manpower available, including staff for equipment maintenance arrangements for shifts, and call-out procedures;
- (i) deployment of equipment and tactical approaches to be used;
- (j) general principles to be followed in deciding when to close runways for snow clearance and designation of management personnel authorised to take the decision;
- (k) methods of assessing and reporting the surface conditions; and
- (l) criteria for the suspension of runway operations.

[applicable from 12 August 2021]



## AMC2 ADR.OPS.B.035(a) Operations in winter conditions

ED Decision 2021/003/R

### ESTABLISHMENT OF PRIORITIES

The aerodrome operator should establish the order of priority for snow, slush and ice clearance, from the movement area, in consultation with the air traffic services, rescue and firefighting services and aircraft operators.

*[applicable from 12 August 2021]*

## AMC1 ADR.OPS.B.035(a)(1) Operations in winter conditions

ED Decision 2021/003/R

### USE OF MATERIALS FOR DE-/ANTI-ICING OF PAVED SURFACES

- (a) The aerodrome operator should use materials to remove or to prevent the formation of ice and frost on aerodrome pavements or to improve runway surface friction characteristics when conditions indicate that their use could be effective. Caution should be exercised in the application of the materials so as not to create more slippery conditions.
- (b) The aerodrome operator should, as far as practicable, avoid harmful effects on environment, aircraft or pavements when using chemicals to remove snow, slush, or ice from operational surfaces.

*[applicable from 12 August 2021]*

## AMC1 ADR.OPS.B.035(a)(2) Operations in winter conditions

ED Decision 2021/003/R

### REMOVAL OF CONTAMINANTS

The aerodrome operator should ensure that:

- (a) snow, slush, and ice are removed from the surface of a paved runway, as rapidly and completely as possible, to minimise accumulation;
- (b) operational taxiways are kept clear of snow slush or ice to the extent necessary to enable aircraft to be taxied to and from an operational runway; and
- (c) those parts of the apron which are intended to be used by aircraft are kept clear of snow, slush or ice, to the extent necessary to enable aircraft to manoeuvre safely, or where appropriate, to be towed or pushed.

*[applicable from 12 August 2021]*

## GM1 ADR.OPS.B.035(b)(3) Operation in winter conditions

ED Decision 2021/003/R

### INFORMATION ON ALKALI-ORGANIC RUNWAY DE-/ANTI-ICING SUBSTANCES

During winter operations, the aircraft carbon brakes and open wheel/bay are exposed to alkali-organic salt runway de-/anti-icing substances during taxi, take-off and landing. A slush mixture of snow and alkali-organic salt de-/anti-icing substances could freeze onto the landing gear and inside the wheel well/bay. After landing gear retraction, the frozen slush deposits begin to melt. The resulting liquid flows into the core of the carbon brake, further contaminating the carbon discs. The presence of the

alkali-organic salt creates a catalytic condition lowering the oxidation temperature of the carbon, resulting in structural deterioration of the carbon disc material and reducing the service life and long-term efficiency of the brakes.

It is very important that aircraft operators have information on the de-/anti-icing substances used at the aerodrome that they operate to and from, in order to assess the exposure of their aircraft to these substances and adjust their maintenance programme.

The information, when provided in the RCR or in the AIP, should be given using the following abbreviations/words:

- (a) KAC, for potassium acetate fluids;
- (b) KFOR, for potassium formate fluids;
- (c) GAC, for glycerine acetate fluids;
- (d) NAFO, for sodium formate solids;
- (e) NAAC, for sodium acetate solids;
- (f) EG, for ethylene glycol fluids;
- (g) PG, for propylene glycol fluids;
- (h) UREA; and
- (i) SAND.

*[applicable from 12 August 2021]*

## **ADR.OPS.B.036 Operations on specially prepared winter runways**

*Delegated Regulation (EU) 2020/2148*

- (a) An aerodrome operator may, subject to the prior approval of the competent authority, establish and use procedures for the operation of aeroplanes on specially prepared winter runways, when the contaminant type is compacted snow or ice. Specially prepared winter runways may be associated with primary RWYCC 4; however, if treatment does not justify a RWYCC 4, the normal procedure in accordance with [point ADR.OPS.B.037](#) shall apply.
- (b) In order to obtain prior approval by the competent authority, the aerodrome operator shall:
  - (1) establish procedures which include the following:
    - (i) the type of equipment or the type, the quality and the quantity of the material, or both, which are used to improve runway surface condition and method of application;
    - (ii) monitoring the meteorological parameters;
    - (iii) management of loose contaminants;
    - (iv) assessment of the achieved results;
  - (2) obtain aeroplane data that relates to stopping performance on the runway with the special treatment from at least one aeroplane operator;
  - (3) analyse and process the data obtained under point (2), in order to demonstrate the capability to establish runway conditions in accordance with a given RWYCC;

- (4) establish a maintenance programme that covers both preventive and corrective maintenance for equipment which is used in order to achieve consistent performance.
- (c) The aerodrome operator shall establish and implement a programme to monitor the continuous effectiveness of the procedure. The programme shall use braking action reports from aeroplane data that shall be compared with the reported runway conditions.
- (d) The aerodrome operator shall evaluate the performance of winter operations after the end of the winter period in order to identify necessity for:
  - (1) additional training requirements;
  - (2) update of the procedures;
  - (3) additional or different equipment and materials.

*[applicable from 12 August 2021]*

## **AMC1 ADR.OPS.B.036(b)(1)(i) Operations on specially prepared winter runways**

*ED Decision 2021/003/R*

### **PROCEDURES FOR USE OF SAND OR GRIT**

The aerodrome operator, when using sand or grit, should:

- (a) if the runway is contaminated with compacted snow:
  - (1) use sand or grit at an application rate appropriate to achieve the desired effect;
  - (2) use sand or grit where the grain passes through a 4.75 mm sieve; and
  - (3) remove as completely as possible any loose contaminants;
- (b) if the runway is contaminated with ice:
  - (1) remove as completely as possible any loose contaminants;
  - (2) use sand or grit at an application rate appropriate to achieve the desired effect; when the air temperature is stable and the surface temperature is below freezing, consider using frozen sand or grit; and
  - (3) use sand or grit where the grain passes through a 4.75 mm sieve;
- (c) ensure that sand or grit maintains the required specifications until application.

*[applicable from 12 August 2021]*

## **GM1 ADR.OPS.B.036(b)(1)(i) Operations on specially prepared winter runways**

*ED Decision 2021/003/R*

### **PROCEDURES FOR USE OF SAND OR GRIT**

The application rate depends on several parameters including temperature, wind speed, vehicle speed, the quality of the material, wear and tear from operations and local experience. Consideration needs to be given to the application rate in order to achieve the desired effect. Very low application

rate may only tolerate a very limited number of operations or pass by the sweeping machines, whereas higher application rates may be detrimental to the effectiveness of the treatment.

In order to ensure that the sand or grit is in contact with the aeroplane tyres during operations, the surface needs to be free of any loose contaminants. In practical terms, sand or grit is visible during operations.

Light precipitation or drifting snow needs to be removed to ensure the effectiveness of the treatment.

The need to ensure that the material maintains the required specification until application requires that actions be taken in order to ensure that no foreign objects are mixed with the sand or grit from origin to the dispenser vehicle, and storage is in a suitable environment to avoid the formation of frozen lumps.

*[applicable from 12 August 2021]*

## **AMC1 ADR.OPS.B.036(b)(1)(ii) Operations on specially prepared winter runways**

*ED Decision 2021/003/R*

### **METEOROLOGICAL PARAMETERS**

In order to ensure the effectiveness of the use of materials, the aerodrome operator should establish limitations and ranges for when the procedures may be applied using the following meteorological parameters:

- (a) air temperature;
- (b) surface temperature (when available);
- (c) dew point; and
- (d) wind speed and direction.

*[applicable from 12 August 2021]*

## **GM1 ADR.OPS.B.036(b)(1)(iii) Operations on specially prepared winter runways**

*ED Decision 2021/003/R*

### **MANAGEMENT OF LOOSE SAND OR GRIT**

Excess sand or grit no longer adhering to the surface can reduce aircraft braking performance and could be ingested by engines. When using sand or grit, it is essential that the aerodrome operator monitors the situation and removes loose sand or grit from the operational surfaces as soon as possible. Excess sand or grit can be efficiently removed by mechanical sweeping and blowing.

*[applicable from 12 August 2021]*

## AMC1 ADR.OPS.B.036(b)(1)(iv) Operations on specially prepared winter runways

ED Decision 2021/003/R

### ASSESSMENT OF ACHIEVED RESULTS

- (a) The procedures should define the operational objectives for specially prepared winter runways.
- (b) The aerodrome operator, when operating in accordance with the requirements for specially prepared winter runways, should monitor continuously and assess the achieved results.
- (c) In case of deviations from operational objectives when materials are applied, the aerodrome operator should take mitigating actions to correct the achieved results and inform aeroplane operators as necessary.

*[applicable from 12 August 2021]*

## GM1 ADR.OPS.B.036(b)(1)(iv) Operations on specially prepared winter runways

ED Decision 2021/003/R

### ASSESSMENT OF ACHIEVED RESULTS

The operational objectives are aligned with the need to establish a runway surface at least with friction characteristics commensurate with RWYCC 4. This could mean a need to apply materials (sand, grit or chemicals) and to assess whether frozen sand can be applied.

If it is assessed that the treatment (frozen sand or other method) has not achieved the desired results (i.e. at least the equivalent of RWYCC 4), a specially prepared winter runway is reported with the appropriately downgraded RWYCC, and in the RCR free text field, the word 'DOWNGRADED' is used.

Depending on the actual weather and traffic conditions, the continuous monitoring and assessment of the achieved results may be carried out by the same staff operating the equipment for surface treatment or by staff operating an independent vehicle in contact with the equipment operator.

*[applicable from 12 August 2021]*

## AMC1 ADR.OPS.B.036(b)(2) Operations on specially prepared winter runways

ED Decision 2021/003/R

### AEROPLANE DATA

The aeroplane data related to stopping performance should:

- (a) include a timestamp for each flight and be related to the subject runway;
- (b) contain all necessary parameters for the chosen method of analysis, recorded with an appropriate frequency; and
- (c) permit the isolation of the effective braking action.

If available, braking action information identified by a third party from aeroplane data may be used when it can be related to specific landings on the subject runway.

*[applicable from 12 August 2021]*

## GM1 ADR.OPS.B.036(b)(2) Operations on specially prepared winter runways

ED Decision 2021/003/R

### AEROPLANE DATA ANALYSIS

The analysis of aeroplane performance data for the purpose of deducing available braking action usually implies the isolation of the total friction force. Either isolating the friction coefficient or comparing the actual stopping capability with a reference capability permits identification of a RWYCC experienced by the aeroplane. Typically, this requires a technical or simulation model of the aeroplane performance produced by the manufacturer. The analysis may be performed through a third party or through the resources of the aeroplane manufacturer. The aeroplane operator planning to perform operations on a specially prepared winter runway needs to set up the arrangement with the aeroplane manufacturer.

*[applicable from 12 August 2021]*

## AMC1 ADR.OPS.B.036(b)(3) Operations on specially prepared winter runways

ED Decision 2021/003/R

### DEMONSTRATION OF CAPABILITY TO ESTABLISH THE RUNWAY SURFACE CONDITION IN ACCORDANCE WITH A GIVEN RUNWAY CONDITION CODE

In order to demonstrate the capability to establish the runway surface condition in accordance with a given RWYCC, the aerodrome operator should demonstrate with a statistical level of confidence of 95 per cent that the actual braking action indicated by aeroplane data is consistently the same as or better than that expected for the reported RWYCC.

*[applicable from 12 August 2021]*

## GM1 ADR.OPS.B.036(b)(3) Operations on specially prepared winter runways

ED Decision 2021/003/R

### DEMONSTRATION OF CAPABILITY TO ESTABLISH THE RUNWAY SURFACE CONDITION IN ACCORDANCE WITH A GIVEN RUNWAY CONDITION CODE

The statistical level of confidence is established by analysing data obtained from aeroplane operators and data from aerodrome operators. The analysis is done by the aerodrome operator.

The experienced RWYCC is compared with the RWYCC reported by the aerodrome operator. An analysis is performed to calculate the statistical level of confidence for the number of landings when the reported RWYCC was deemed the same as or better than the experienced RWYCC.

To obtain statistical significance, a representative number of landings on a winter-contaminated surface prepared such as intended to benefit from the improved braking action used in the demonstration should be as large as possible, but not less than 30.

*[applicable from 12 August 2021]*

## GM1 ADR.OPS.B.036(b)(4) Operations on specially prepared winter runways

ED Decision 2021/003/R

### MAINTENANCE PROGRAMME

- (a) The maintenance programme should include at least the following equipment:
  - (1) sand spreaders including heating and pre-wetting equipment; and
  - (2) chemical spreaders.
- (b) The maintenance programme should include regular verification of the accuracy of distribution rates and temperature measurements for material spreaders.

*[applicable from 12 August 2021]*

## AMC1 ADR.OPS.B.036(c) Operations on specially prepared winter runways

ED Decision 2021/003/R

### MONITORING PROGRAMME — PERFORMANCE INDICATORS

The aerodrome operator should:

- (a) establish a system of performance indicators to systematically monitor the effectiveness of the procedures which are applied to support operations on specially prepared winter runways;
- (b) record the performance indicators on a monthly basis during the winter season for each runway and review them on an annual basis; and
- (c) prepare and make available an annual report, which includes comparison with the performance indicators of at least the previous 3 years.

*[applicable from 12 August 2021]*

## GM1 ADR.OPS.B.036(c) Operations on specially prepared winter runways

ED Decision 2021/003/R

### MONITORING PROGRAMME — PERFORMANCE INDICATORS

The following performance indicators may be used in order to monitor the success in correctly assessing and reporting the runway surface condition:

- (a) Proportion of landings on reported RWYCC 4 versus total number of landings on specially prepared winter runways. The indicator aims to measure the frequency of operations on specially prepared winter runways where no downgrade has been used;
- (b) Proportion of landings identified under (a) where the braking action computed based on aeroplane data was one RWYCC worse than the RCRs issued by the aerodrome operator;
- (c) Proportion of landings identified under (a) where the braking action computed based on aeroplane data was two RWYCCs worse than the RCRs issued by the aerodrome operator.

- (d) Number of movements on a contaminated runway (RWYCC 1–4) per total number of movements. This number provides an indication of the exposure of the aerodrome to winter conditions. Information concerning the contamination of the runway can be derived from the RCRs.

The indicators mentioned in (a), (b) and (c) provide information concerning the quality of the runway surface condition assessment.

Performance indicators should be recorded on a monthly basis.

*[applicable from 12 August 2021]*

## ADR.OPS.B.037 Assessment of runway surface condition and assignment of runway condition code

*Delegated Regulation (EU) 2020/2148*

Whenever the contaminants listed in points [ADR.OPS.A.060](#)(a) to (e) are present on the surface of a runway, the aerodrome operator shall:

- (a) assign a RWYCC based on the type and depth of the contaminant and temperature;
- (b) inspect the runway whenever the runway surface condition may have changed due to meteorological conditions, assess the runway surface condition and assign a new RWYCC;
- (c) use special air-reports to trigger reassessment of RWYCC.

*[applicable from 12 August 2021]*

## AMC1 ADR.OPS.B.037(a) Assessment of runway surface condition and assignment of runway condition code

*ED Decision 2021/003/R*

### RUNWAY CONDITION ASSESSMENT MATRIX (RCAM)

The aerodrome operator should use the following RCAM in order to assign the RWYCC:

Runway condition assessment matrix (RCAM)			
Assessment criteria		Downgrade assessment criteria	
RWYCC	Runway surface description	Aeroplane deceleration or directional control observation	Special air-report of runway braking action
6	DRY	-	-
5	<ul style="list-style-type: none"> <li>— FROST</li> <li>— WET (The runway surface is covered by any visible dampness or water up to and including 3 mm depth)</li> <li><b>Up to and including 3 mm depth:</b></li> <li>— SLUSH</li> </ul>	Braking deceleration is normal for the wheel braking effort AND directional control is normal	GOOD



	<ul style="list-style-type: none"> <li>— DRY SNOW</li> <li>— WET SNOW</li> </ul>		
4	<ul style="list-style-type: none"> <li>— SPECIALLY PREPARED WINTER RUNWAY</li> <li>— <b>-15°C and lower outside temperature</b></li> <li>— COMPACTED SNOW</li> </ul>	Braking deceleration OR directional control is between good and medium	GOOD TO MEDIUM
3	<ul style="list-style-type: none"> <li>— SLIPPERY WET</li> <li>— DRY SNOW or WET SNOW (any depth) ON TOP OF COMPACTED SNOW</li> <li>— <b>More than 3 mm depth:</b></li> <li>— DRY SNOW</li> <li>— WET SNOW</li> <li>— <b>Higher than -15°C outside air temperature:</b></li> <li>— COMPACTED SNOW</li> </ul>	Braking deceleration is noticeably reduced for the wheel braking effort applied OR directional control is noticeably reduced	MEDIUM
2	<ul style="list-style-type: none"> <li>— <b>More than 3 mm:</b></li> <li>— STANDING WATER</li> <li>— SLUSH</li> </ul>	Braking deceleration OR directional control is between medium and poor	MEDIUM TO POOR
1	<ul style="list-style-type: none"> <li>— ICE</li> </ul>	Braking deceleration is significantly reduced for the wheel braking effort applied OR directional control is significantly reduced	POOR
0	<ul style="list-style-type: none"> <li>— WET ICE</li> <li>— WATER ON TOP OF COMPACTED SNOW</li> <li>— DRY SNOW or WET SNOW ON TOP OF ICE</li> </ul>	Braking deceleration is minimal to non-existent for the wheel braking effort applied OR directional control is uncertain	LESS THAN POOR

Aerodromes which never experience or never report snow and ice conditions, may use the following simplified form of RCAM:

Runway condition assessment matrix (RCAM)			
Assessment criteria		Downgrade assessment criteria	
RWYCC	Runway surface description	Aeroplane deceleration or directional control observation	Special air-report of runway braking action
6	DRY	-	-
5	— WET (The runway surface is covered by any visible dampness or water up to and including 3 mm depth)	Braking deceleration is normal for the wheel braking effort AND directional control is normal	GOOD
4		Braking deceleration OR directional control is between good and medium	GOOD TO MEDIUM
3	— SLIPPERY WET	Braking deceleration is noticeably reduced for the wheel braking effort applied OR directional control is noticeably reduced	MEDIUM
2	<b>More than 3 mm:</b> — STANDING WATER	Braking deceleration OR directional control is between medium and poor	MEDIUM TO POOR
1		Braking deceleration is significantly reduced for the wheel braking effort applied OR directional control is significantly reduced	POOR
0		Braking deceleration is minimal to non-existent for the wheel braking effort applied OR directional control is uncertain	LESS THAN POOR

[applicable from 12 August 2021]

## GM1 ADR.OPS.B.037(a) Assessment of runway surface condition and assignment of runway condition code

ED Decision 2021/003/R

### AVAILABLE MEANS USED TO DETERMINE THE RWYCC

- (a) The visual inspection of the movement area to assess the surface condition is the core method to determine the RWYCC. An overall assessment however implies more than that. The continuous monitoring of the development of the situation and the prevailing weather conditions is essential to ensure safe flight operations. Other aspects to be considered in the

assessment result are the outside air temperature, the surface temperature, the dew point, the wind speed and direction, the effect of surface treatment, control and deceleration of the inspection vehicle, the special air-reports of braking action, the output from friction measuring devices, the weather forecast, etc. Due to interaction between them, a deterministic method on how these factors affect the RWYCC to be reported cannot be precisely defined.

- (b) The RCAM supports the classification of runway surface conditions by their effect on aeroplane braking performance using a set of criteria identified and quantified based on the best industry knowledge, built upon dedicated flight testing and in-service experience. The thresholds at which a criterion changes the classification of a surface condition are intended to be reasonably conservative, without being excessively pessimistic.
- (c) The following describes why the primary classification criteria in the RCAM have been set this way, and why it is important for aerodrome personnel to monitor and accurately report conditions when operating close to the boundaries of each RWYCC:

- (1) Percentage of coverage with contamination in each runway third

A runway is considered contaminated whenever the extent of the coverage is more than a quarter of the surface of at least one third of the runway. It is important to note that whenever coverage is assessed to be below the 25 per cent threshold in each third, the computation assumption made by flight crew will be a dry runway (uniformly bare of moisture, water and contamination). It has been demonstrated that in conditions of contamination just below the reporting threshold but concentrated in the most unfavourable location, this assumption of dry runway still provides positive stop margins.

- (2) Type of contaminant

Different contaminants affect the contact area between tyre and runway surface, where the stopping force is generated, in different ways. A water film of any depth leads to the partial (viscous aquaplaning) or total separation (dynamic aquaplaning) of the tyre from the surface. The smaller the surface, the smaller the force of adhesion, the less braking is available. Therefore, the maximum braking force decreases at higher speed and depends on contaminant depth. Other fluid contaminants have a similar effect. Hard contaminants, such as ice or compacted snow, prevent the contact between tyre and runway surface completely and at any speed, effectively providing a new surface that the tyre rolls on. A deterministic classification of the stopping performance can be made only for the contaminants listed in the RCAM. For other reportable contaminants (oil, mud, ash, etc.), a large variance in the aeroplane performance effect exists, or insufficient data is available to permit a deterministic classification. An exception is rubber contamination, for which in-service data indicates that an assumption of RWYCC 3 provides a satisfactory performance margin. Runway surface treatments with sand, grit or chemicals may be very effective or even detrimental depending on the conditions of the application, and no credit can be attributed to such treatment without verification and validation.

- (3) Depth of the contamination

The industry accepts that the threshold for the effect of depth of fluid contaminants on aeroplane performance is at 3 mm. Below this threshold, any type of fluid contaminant can be removed from the tyre/runway contact zone either by forced drainage or by compressing it into the macrotecture of the surface, thus allowing adhesion between tyre and surface to exist, albeit on less than the full footprint surface area. This is the reason why contamination depths up to 3 mm are expected to provide similar stopping

performance as a wet runway. It should be noted that the physical effects causing reduced friction forces begin to take effect from very small film thickness, therefore damp conditions are considered to provide no better braking action than a wet runway. Aerodrome personnel need to be aware of the fact that the capability to generate friction in wet (or with thin layers of fluid contaminants) conditions is very dependent upon the inherent qualities of the runway surface (friction characteristics) and may be less than normally expected on poorly drained, polished or rubber contaminated surfaces. Above the 3 mm threshold, the impact on friction forces is more significant, leading to classification in lower RWYCCs. Above this depth, and depending on the density of the fluid, additional drag effects start to apply, due to displacement or compression of the fluid and impingement on the airframe of the aeroplane. These latter effects depend on the depth of the fluid and affect the ability of the aeroplane to accelerate for take-off.

(4) Surface or air temperature

It is self-evident that close to the freezing point significant changes in surface conditions can occur very quickly. Surface temperature is more significant for the relevant physical effects, and surface and air temperature may be significantly different due to latency and radiation. However, surface temperature may not be readily available, and it is acceptable to use air temperature as a criterion for the contaminant classification. The threshold for the classification of compacted snow in RWYCC 4 (below OAT -15 degrees) or RWYCC 3 (above this temperature) is based on historical North American operational practice and may be very conservative, therefore other assessment means should be used to support the classification. Such assessment means should be based upon specific rationale, specific procedures and substantiating aeroplane data.

*[applicable from 12 August 2021]*

## **GM2 ADR.OPS.B.037(a) Assessment of runway surface condition and assignment of runway condition code**

*ED Decision 2021/003/R*

ICE is considered to be untreated ice that covers the runway macrotexture.

*[applicable from 12 August 2021]*

## **AMC1 ADR.OPS.B.037(a);(b) Assessment of runway surface condition and assignment of runway condition code**

*ED Decision 2021/003/R*

### **ASSIGNMENT OF RUNWAY CONDITION CODE**

- (a) The aerodrome operator should:
- (1) assign a RWYCC 6, if 25 per cent or less area of a runway third is wet or covered by contaminant;
  - (2) describe in the plain-language remarks part of the situational awareness section of the RCR the location of the area that is wet or covered by the contaminant, if the distribution of the contaminant is not uniform;

- (3) assign a RWYCC based on the contaminant that will most likely affect the aeroplane's performance, if multiple contaminants are present and the total coverage is more than 25 per cent but no single contaminant covers more than 25 per cent of any runway third;
  - (4) not upgrade an assigned RWYCC 5, 4, 3, or 2; and
  - (5) not upgrade beyond RWYCC 3 an assigned RWYCC 1 or 0.
- (b) The aerodrome operator may upgrade an assigned RWYCC 1 or 0 when all available means of assessing runway slipperiness, including properly operated and calibrated measuring devices, if available, have been used to support the decision.
  - (c) The aerodrome operator, when RWYCC 1 or 0 is upgraded, should assess the runway surface frequently during the period the higher RWYCC is in effect, to ensure that the runway surface condition does not deteriorate below the assigned code.
  - (d) The aerodrome operator, if sand or other runway treatments are used to support upgrading of the RWYCC, should assess the runway surface frequently to ensure the continued effectiveness of the treatment.
  - (e) The aerodrome operator should appropriately downgrade the RWYCC taking into consideration all available means of assessing runway slipperiness, including special air-reports.
  - (f) The aerodrome operator, when the primary assignment of the RWYCC in accordance with RCAM does not reflect the prevailing conditions accurately, and is supported by other observations, experience and local knowledge, should downgrade or upgrade the RWYCC. In this case:
    - (1) the RWYCC should be the downgraded or upgraded RWYCC following the overall assessment;
    - (2) the description of the runway surface contaminant will reflect the actual condition; and
    - (3) in the plain language remarks section of the RCR, the terms 'UPGRADED' or 'DOWNGRADED' should be used.

*[applicable from 12 August 2021]*

## **GM1 ADR.OPS.B.037(b) Assessment of runway surface condition and assignment of runway condition code**

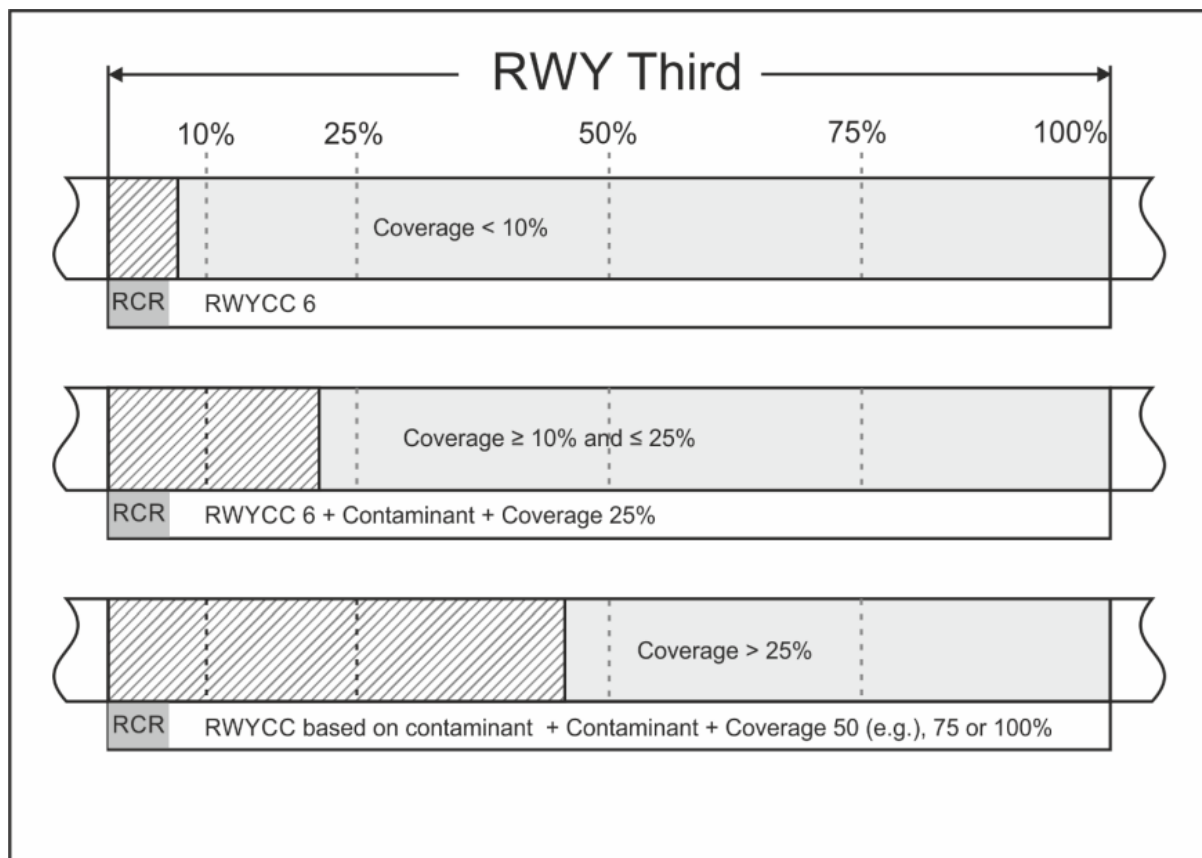
*ED Decision 2021/003/R*

### **SINGLE AND MULTIPLE CONTAMINANTS**

When single or multiple contaminants are present, the RWYCC for any third of the runway is determined as follows:

- (a) When the runway third contains a single contaminant, the RWYCC for that third is based directly on that contaminant in the RCAM as follows:
  - (1) If the contaminant coverage for that third is less than 10 per cent, a RWYCC 6 is to be generated for that third, and no contaminant is to be reported. If all thirds have less than 10 per cent contaminant coverage, no report is generated; or
  - (2) If the contaminant coverage for that third is greater than or equal to 10 per cent and less than or equal to 25 per cent, a RWYCC 6 is to be generated for that third and the contaminant reported at 25 per cent coverage; or

- (3) If the contaminant coverage for that third is greater than 25 per cent, the RWYCC for that third is based on the contaminant present.



*Figure 1: Single contaminant*

- (b) If multiple contaminants are present where the total coverage is more than 25 per cent but no single contaminant covers more than 25 per cent of any runway third, the RWYCC is based upon the judgement of the runway inspector, considering what contaminant will most likely be encountered by the aeroplane and its likely effect on the aeroplane's performance. Typically, this would be the most widespread contaminant, but this is not an absolute.
- (c) The structure of the RCAM is ranking the contaminants in the column 'Runway surface description' from top to bottom and is having the most slippery contaminants at the bottom. However, this ranking is not an absolute, as the RCAM by design is landing oriented and if judged in a take-off scenario, the ranking could be different due to drag effects of loose contaminants.

*[applicable from 12 August 2021]*

## GM2 ADR.OPS.B.037(b) Assessment of runway surface condition and assignment of runway condition code

*ED Decision 2021/003/R*

### DOWNGRADING AND UPGRADING

- (a) The RCAM allows making an initial assessment based on visual observation of contaminants on the runway surface: their type, depth and coverage, as well as the outside air temperature.

Downgrading and upgrading is an integral part of the assessment process and essential to developing relevant reports of the prevailing runway surface condition.

- (b) Examples of aspects to be considered in assessing the runway slipperiness for the downgrade process:
- (1) Prevailing weather conditions
    - (i) stable sub-freezing temperature
    - (ii) dynamic conditions
    - (iii) active precipitation.
  - (2) Observations
  - (3) Measurements
    - (i) friction measurements
    - (ii) vehicle behaviour
    - (iii) shoe scraping
  - (4) Experience (local knowledge)
  - (5) Special air-reports
- (c) When the complete removal of contaminants cannot be achieved, but the RWYCC initially assigned does not reflect the real surface condition, the aerodrome personnel may apply the upgrade procedures. Upgrading is applicable only when the initial RWYCC is 0 or 1. Upgrading can only occur up to RWYCC 3.
- (d) When upgrading RWYCC 0 and 1, a preponderance of evidence needs to exist pointing towards the higher RWYCC.
- (e) When a friction measuring device is used for upgrading purposes, a preponderance of evidence needs to exist. In order to upgrade a RWYCC 0 or 1 to no higher than RWYCC 3, the friction measuring device needs to demonstrate an equivalent friction to that of a wet runway (RWYCC 5) or higher.

*[applicable from 12 August 2021]*

## **AMC1 ADR.OPS.B.037(c) Assessment of runway surface condition and assignment of runway condition code**

*ED Decision 2021/003/R*

### **USE OF SPECIAL AIR-REPORT**

- (a) The aerodrome operator should:
- (1) re-assess the runway surface condition if RWYCC 2 or better has been reported and two consecutive special air-reports of POOR runway braking action are received; and
  - (2) re-assess the runway surface condition and consider the suspension of operations on that runway when one pilot has reported a LESS THAN POOR runway braking action.
- (b) The aerodrome operator may use a special air-report of runway braking action for upgrading purposes only if it is used in combination with other information qualifying for upgrading.

*[applicable from 12 August 2021]*

## **GM1 ADR.OPS.B.037(c) Assessment of runway surface condition and assignment of runway condition code**

*ED Decision 2021/003/R*

### **USE OF SPECIAL AIR-REPORTS**

Special air-reports typically provide aerodrome personnel and other pilots with an observation that can confirm the ground-based assessment of or alert to degraded conditions experienced in terms of braking capability and/or lateral control during the landing roll. The braking action observed is dependent on the type of aircraft, aircraft weight, runway portion used for braking, and other factors. Pilots will use the terms GOOD, GOOD TO MEDIUM, MEDIUM, MEDIUM TO POOR, POOR and LESS THAN POOR. When receiving a special air-report, the recipient needs to consider that it rarely applies to the full length of the runway and is limited to the specific sections of the runway surface in which sufficient wheel braking was applied to reach friction limitation. As special air-reports are subjective and contaminated runways may affect the performance of different aeroplane types in a different way, the reported braking action may not be directly applicable to another aeroplane.

*[applicable from 12 August 2021]*

## **ADR.OPS.B.040 Night operations**

*Regulation (EU) No 139/2014*

The aerodrome operator shall ensure that means and procedures are established and implemented for providing safe conditions for aerodrome operation during night operations.

### **AMC1 ADR.OPS.B.040 Night Operations**

*ED Decision 2014/012/R*

#### **GENERAL**

The aerodrome operator for aerodromes operated at night should, in collaboration with air traffic services provider, ensure that visual aids are installed, operated, and maintained to permit aircraft operations to be performed safely.

## **ADR.OPS.B.045 Low visibility operations**

*Regulation (EU) No 139/2014*

- (a) The aerodrome operator shall ensure that means and procedures are established and implemented for providing safe conditions for aerodrome operations in low visibility conditions.
- (b) Low visibility procedures shall require prior approval by the Competent Authority.

### **AMC1 ADR.OPS.B.045 Low visibility operations**

*ED Decision 2014/012/R*

#### **GENERAL**

- (a) The aerodrome operator should, in collaboration with air traffic services provider and the provider of apron management services, if applicable, establish procedures for low visibility



operations when lower than Standard Category I, other than Standard Category II, Category II and III approaches and low visibility take-offs are conducted.

- (b) When low visibility procedures (LVP) are in effect, the aerodrome operator should make available to aeronautical information services and/or air traffic services, as appropriate, information on the status of the aerodrome facilities.
- (c) The aerodrome operator should establish and implement procedures to ensure that when low visibility procedures (LVP) are in effect, persons and vehicles operating on an apron are restricted to the essential minimum.
- (d) The procedures to be established by the aerodrome operator to ensure safe aerodrome operations during low visibility conditions should cover the following subjects:
  - (1) physical characteristics of the runway environment, including pre-threshold, approach and departure areas;
  - (2) obstacle limitation surfaces;
  - (3) surveillance and maintenance of visual aids;
  - (4) safeguarding of non-visual aids essential to low visibility procedures;
  - (5) secondary power supplies;
  - (6) movement area safety;
  - (7) RFFS.

## ADR.OPS.B.050 Operations in adverse weather conditions

*Regulation (EU) No 139/2014*

The aerodrome operator shall ensure that means and procedures are established and implemented to ensure the safety of aerodrome operations in adverse weather conditions.

## AMC1 ADR.OPS.B.050 Operations in adverse weather conditions

*ED Decision 2014/012/R*

### PROCEDURES

The aerodrome operator should, together with the air traffic services and other relevant parties operating at the aerodrome, establish and implement procedures required to mitigate the risk of operation of the aerodrome under adverse weather conditions such as strong winds, heavy rain, and thunderstorms, including the suspension of operations on the runway(s) if deemed necessary.

## ADR.OPS.B.055 Fuel quality

*Regulation (EU) No 139/2014*

The aerodrome operator shall verify that organisations involved in storing and dispensing of fuel to aircraft have procedures to ensure that aircraft are provided with uncontaminated fuel and of the correct specification.

## AMC1 ADR.OPS.B.055 Fuel quality

ED Decision 2014/012/R

### GENERAL

The aerodrome operator should verify, either by itself or through arrangements with third parties, that organisations involved in storing and dispensing of fuel to aircraft, implement procedures to:

- (a) maintain the installations and equipment for storing and dispensing the fuel in such condition so as not to render unfit for use in aircraft;
- (b) mark such installations and equipment in a manner appropriate to the grade of the fuel;
- (c) take fuel samples at appropriate stages during the storing and dispensing of fuel to aircraft, and maintain records of such samples; and
- (d) use adequately qualified and trained staff in storing, dispensing, and otherwise handling fuel on the aerodrome.

## GM1 ADR.OPS.B.055 Fuel quality

ED Decision 2014/012/R

### COMPLIANCE

The aerodrome operator, in order to ensure compliance, could use:

- (a) audit reports to organisations involved in storing and dispensing of fuel to aircraft, or
- (b) relevant national procedures providing for the assurance of fuel quality.

## ADR.OPS.B.065 Visual aids and aerodrome electrical systems

Regulation (EU) No 139/2014

The aerodrome operator shall have procedures to ensure that aerodrome visual aids and electrical systems function as intended.

## AMC1 ADR.OPS.B.065 Visual aids and aerodrome electrical systems

ED Decision 2021/003/R

### GENERAL

- (a) The aerodrome operator should establish a monitoring system of aerodrome ground lights so as to inform the air traffic services provider when safe operation is no longer possible.
- (b) The aerodrome operator should establish procedures for the operation of visual aids and, in coordination with the air traffic services provider, procedures to be implemented in the event of unserviceability of stop bars. The procedures should cover the situation where the stop bars cannot be turned off because of a technical problem, and the measures to be taken should not undermine the principle that a lit stop bar must not be crossed.
- (c) The aerodrome operator should establish procedures for the provision and removal of temporary markings, lights and signs.

## GM1 ADR.OPS.B.065 Visual aids and aerodrome electrical systems

*ED Decision 2021/003/R*

### UNSERVICEABILITY OF STOP BARS

In situations where the stop bars cannot be turned off because of a technical problem, the following contingency measures may, inter alia, be considered:

- (a) physically disconnecting the respective lit stop bar from its power supply;
- (b) physically obscuring the lights of the lit stop bar; and
- (c) using a different route, until the malfunctioning system has been repaired.

In case of implementation of (a) or (b), a marshaller or a follow-me vehicle may need to be provided to lead the aircraft to cross the stop bar. Moreover, in case of implementation of (b), care is necessary to ensure correct implementation of the measure to avoid misunderstandings by the flight crew.

In any case, the measures taken do not undermine the principle that a lit stop bar must not be crossed, while maintenance action needs to be taken as soon as possible.

## ADR.OPS.B.070 Aerodrome works safety

*Regulation (EU) No 139/2014*

- (a) The aerodrome operator shall establish and implement procedures to ensure that:
  - (1) aircraft safety is not affected by aerodrome works; and
  - (2) aerodrome works safety is not affected by aerodrome operational activities.

## AMC1 ADR.OPS.B.070 Aerodrome works safety

*ED Decision 2021/003/R*

### GENERAL

- (a) The procedures should be appropriate to the volume and nature of operations at the aerodrome.
- (b) Construction or maintenance work on the movement area, or work affecting aerodrome operations should be planned, established, implemented, or approved by the aerodrome operator.
- (c) The scope of work, physical extent, and time period should be notified to the relevant parties concerned. If such work will render limitations to the use of a particular runway, additional measures should be implemented to ensure safety. In case the works necessitate the temporary change of the declared distances of the runway, a recalculation of the declared distances should be performed, in accordance with an established procedure, and the relevant information should be provided to the Competent Authority, the air traffic services and aeronautical information services unit, before the implementation of the new declared distances. The aerodrome operator should also request the broadcast of relevant information via the local ATIS.
- (d) Roles and responsibilities for operations and tasks associated with the reduction of runway length available and the work in progress (WIP) are clearly understood and complied with.

- (e) The aerodrome operator should put in place appropriate measures to monitor the safety of the aerodrome and aircraft operations during aerodrome works such that timely corrective action is taken when necessary to assure continued safe operations.
- (f) The aerodrome operator should ensure the works site is returned to operational use in a safe and timely manner by ensuring:
  - (1) the works site is cleared of personnel, vehicles, and plant in a safe and timely manner;
  - (2) The works-affected area is inspected for operational serviceability in accordance with the hand-back procedures; and
  - (3) relevant authorities or organisations are notified of the restoration of aerodrome serviceability in accordance with procedures, using suitable means of communication.

## **AMC2 ADR.OPS.B.070 Aerodrome works safety**

*ED Decision 2021/003/R*

### **RUNWAY PAVEMENT OVERLAYS**

The aerodrome operator should ensure that:

- (a) when a runway is to be returned temporarily to an operational status before resurfacing is complete, the longitudinal slope of the temporary ramp, measured with reference to the existing runway surface or previous overlay course, should be:
  - (1) 0.5 to 1.0 % for overlays up to and including 5 cm in thickness; and
  - (2) not more than 0.5 % for overlays more than 5 cm in thickness.
- (b) Runway overlaying proceeds from one end of the runway towards the other end so that based on runway utilisation, most aircraft operations will experience a down ramp.
- (c) The entire width of the runway is overlaid during each work session.
- (d) Before a runway being overlaid is returned to a temporary operational status, a runway centre line marking, conforming to the applicable specifications included in the aerodrome certification basis of the aerodrome, should be provided.
- (e) The location of any temporary threshold should be identified by a 3.6 m wide transverse stripe.

## **AMC3 ADR.OPS.B.070 Aerodrome works safety**

*ED Decision 2014/012/R*

### **MARKING AND LIGHTING OF UNSERVICEABLE AREAS**

- (a) The aerodrome operator should ensure that:
  - (1) unserviceability markers are displayed whenever any portion of a taxiway, apron, or holding bay is unfit for the movement of aircraft but it is still possible for aircraft to bypass the area safely;
  - (2) on a movement area used at night, unserviceability lights should be used; and
  - (3) Unserviceability markers and lights are placed at intervals sufficiently close so as to delineate the unserviceable area.

- (b) Unserviceability markers should consist of conspicuous upstanding devices such as flags, cones, or marker boards.
- (c) Unserviceability markers and lights should meet the specifications described in [CS ADR.DSN.R.870](#).

## AMC4 ADR.OPS.B.070 Aerodrome works safety

ED Decision 2021/003/R

### CLOSED RUNWAYS AND TAXIWAYS, OR PARTS THEREOF

The aerodrome operator should ensure that:

- (a) a closed marking as defined in [CS ADR-DSN.R.855\(c\)](#) is displayed on a temporarily closed runway, or taxiway, or a portion thereof, except that such a marking may be omitted when the closing is of short duration and adequate warning by air traffic services is provided;
- (b) lighting on a closed runway or taxiway, or a portion thereof is not operated, except as required for maintenance purposes; and
- (c) in addition to closed markings, when the runway, taxiway, or portion thereof is closed and is intercepted by a usable runway or taxiway which is used at night, unserviceability lights as defined in [CS ADR-DSN.R.870\(c\)](#) should be placed across the entrance to the closed area at intervals not exceeding 3 m; and
- (d) a closed runway or taxiway marking as defined in [CS ADR-DSN.R.855\(c\)](#), or a portion thereof, is displayed on new runways and taxiways that are still under construction.

## GM1 ADR.OPS.B.070 Aerodrome works safety

ED Decision 2014/012/R

### MAINTENANCE WORKS

- (a) Persons or sections entering the movement area to perform maintenance should have a written approval by the aerodrome operator.
- (b) Entrance to the movement area should be subject to clearance by the unit responsible for that area (ATC, apron management, aerodrome operator, etc.) using appropriate means (R/T, telephone, etc.).
- (c) Individuals carrying out maintenance works should comply with local rules concerning the control and operation of vehicles in the movement area.

## GM2 ADR.OPS.B.070 Aerodrome works safety

ED Decision 2014/012/R

### MINOR CONSTRUCTION/MAINTENANCE WORK

- (a) A system of work permits should be established for minor works on the movement area.
- (b) The objectives of the work permits should be such that:
  - (1) no work is taking place on the movement area without the knowledge of aerodrome operator's staff and air traffic services;
  - (2) permitted times of work are strictly followed; and

- (3) all individuals taking part in the work are briefed in detail on the following:
  - (i) precise areas in which work may be done;
  - (ii) the routes to be followed to and from the working area;
  - (iii) the R/T procedures to be used;
  - (iv) the safety precautions to be observed , the maintenance of a listening watch and the use of look-outs; and
  - (v) the reporting procedure to be followed on completion of work.
- (c) At the conclusion of work, aerodrome operator's staff, or other appropriate staff, should inspect the working area to ensure that it has been left in a satisfactory condition.

## GM3 ADR.OPS.B.070 Aerodrome works safety

*ED Decision 2014/012/R*

### MAJOR CONSTRUCTION/MAINTENANCE WORK

- (a) Before the commencement of any substantial work on the movement area, a liaison group comprising representatives from the aerodrome operator, air traffic services, apron management services, if applicable, and subcontractors' agents should be established.
- (b) The group could meet, as often as considered necessary, to review progress, and consider the need for any change in working practices to meet operational requirements.
- (c) As far as practicable, working areas should be blocked off from the active parts of the movement area by the erection of physical barriers.
- (d) Consideration should be given to the marking and lighting of barriers.
- (e) The lights of taxiways leading into working areas should be permanently 'off'.
- (f) Before works commence, the following should be established:
  - (1) the hours of work;
  - (2) the authorised routes;
  - (3) the communications facilities to be used;
  - (4) the permitted heights of vehicles and equipment, and the limitations to be placed on operating heights of cranes; and
  - (5) any limitation to be placed on use of electrical equipment which might cause interference with navigational facilities or aircraft communications.
- (g) Contractors should be briefed for possible hazards to personnel working on aerodromes, in particular the jet blast problem and noise.
- (h) Where contractors work on or traverse aircraft pavement areas, these areas should be inspected thoroughly before they are opened again for aircraft use, with particular attention to the presence of debris and the general cleanliness of the surface.
- (i) Where aircraft are constantly using areas open to contractors, inspections at frequent intervals are required to ensure the continuing operational safety of the aerodrome.

- (j) Adequate marking arrangements should be provided for crane jibs when extra conspicuity is considered desirable.
- (k) If work is of prolonged duration, a constant watch is required to ensure that the marking and lighting of obstacles and unserviceable areas does not degrade below acceptable limits.
- (l) The effect of tall cranes on ILS and radar, in conjunction with those responsible for electronic landing aids and steps taken to reduce limitations to the minimum, should be considered.

## **GM4 ADR.OPS.B.070 Aerodromes works safety**

*ED Decision 2014/012/R*

### **USE OF UNSERVICEABILITY LIGHTS**

When lights are used to mark temporary unserviceable areas at night or during reduced visibility conditions, these lights mark the most potentially dangerous extremities of the area. A minimum of four such lights could be used, except where the area is triangular in shape where a minimum of three lights may be employed. The number of lights may be increased when the area is large or of unusual configuration. At least one light should be installed for each 7.5 m of peripheral distance of the area. If the lights are directional, they should be orientated so that, as far as possible, their beams are aligned in the direction from which aircraft or vehicles will approach. Where aircraft or vehicles will normally approach from several directions, consideration should be given to adding extra lights or using omnidirectional lights to show the area from these directions. Unserviceable area lights should be frangible. Their height should be sufficiently low to preserve clearance for propellers and for engine pods of jet aircraft.

## **GM5 ADR.OPS.B.070 Aerodrome works safety**

*ED Decision 2017/017/R*

### **USE OF TEMPORARY RUNWAY MARKINGS**

- (a) Circumstances may occur when it is not practicable to install permanent markings, for example during runway resurfacing. In order to provide sufficient visual guidance to aircraft, the following markings should be considered:
  - (1) runway centre line;
  - (2) taxiway centre line lead on/off;
  - (3) runway edge line;
  - (4) runway threshold; and
  - (5) touchdown zone and aiming point markings.
- (b) Centre line and edge marking widths can be replaced by temporary markings of reduced width from 0.9 m to 0.6 m, if required.
- (c) Touchdown zone and aiming point markings should be painted as soon as possible after the resurface of the runway.
- (d) Threshold markings should be painted as soon as possible, using temporary materials before making them permanent.

## GM6 ADR.OPS.B.070 Aerodrome works safety

ED Decision 2021/003/R

### CLOSED RUNWAY AND TAXIWAY MARKINGS — AVOIDING THE LACK OF CONTRAST

- (a) In certain circumstances, e.g. due to the colour of the material used during construction works, there may be insufficient contrast between the colour of the surface of the runway or taxiway and the colour of the respective closed runway or taxiway marking, even though the latter conforms to the applicable specifications.

This may result in the closed runway or taxiway markings not fulfilling their purpose. To avoid the lack of contrast, the closed runway or taxiway markings need to be included in an appropriate border, whose colour is black.

- (b) At aerodromes where operations take place at night, the closed runway or taxiway markings would be made with reflective materials designed to enhance their visibility. Guidance on reflective materials is given in Part 4 'Visual Aids' of ICAO Doc 9157 'Aerodrome Design Manual'.

## ADR.OPS.B.075 Safeguarding of aerodromes

Regulation (EU) No 139/2014

- (a) The aerodrome operator shall monitor on the aerodrome and its surroundings:
- (1) obstacle limitation and protection surfaces as established in accordance with the certification basis, and other surfaces and areas associated with the aerodrome, in order to take, within its competence, appropriate action to mitigate the risks associated with the penetration of those surfaces and areas;
  - (2) marking and lighting of obstacles in order to be able to take action within its competence, as appropriate; and
  - (3) hazards related to human activities and land use in order to take action within its competence, as appropriate.
- (b) The aerodrome operator shall have procedures in place for mitigating the risks associated with obstacles, developments and other activities within the monitored areas that could impact safe operations of aircraft operating at, to or from the aerodrome.

## AMC1 ADR.OPS.B.075 Safeguarding of aerodromes

ED Decision 2021/003/R

### GENERAL

- (a) The aerodrome operator should have procedures to monitor the changes in the obstacle environment, marking and lighting, and in human activities or land use on the aerodrome and the areas around the aerodrome, as defined in coordination with the Competent Authority. The scope, limits, tasks and responsibilities for the monitoring should be defined in coordination with the relevant air traffic services providers, and with the Competent Authority and other relevant authorities, and should ensure the protection of the sight lines from the established air traffic control tower, apron management services unit, and watch-room of the RFFS station(s), from permanent or temporary obstacles or activities.



- (b) The limits of the aerodrome surroundings that should be monitored by the aerodrome operator are defined in coordination with the Competent Authority and should include the areas that can be visually monitored during the inspections of the manoeuvring area.
- (c) The aerodrome operator should have procedures to mitigate the risks associated with changes on the aerodrome and its surroundings identified with the monitoring procedures. The scope, limits, tasks, and responsibilities for the mitigation of risks associated to obstacles or hazards outside the perimeter fence of the aerodrome should be defined in coordination with the relevant air traffic services providers, and with the Competent Authority and other relevant authorities.
- (d) The risks caused by human activities and land use which should be assessed and mitigated should include:
  - (1) obstacles and the possibility of induced turbulence;
  - (2) the use of hazardous, confusing, and misleading lights;
  - (3) the dazzling caused by large and highly reflective surfaces;
  - (4) sources of non-visible radiation, or the presence of moving, or fixed objects which may interfere with, or adversely affect, the performance of aeronautical communications, navigation and surveillance systems; and
  - (5) non-aeronautical ground light near an aerodrome which may endanger the safety of aircraft and which should be extinguished, screened, or otherwise modified so as to eliminate the source of danger.

## **GM1 ADR.OPS.B.075(a)(1) Safeguarding of aerodromes**

*ED Decision 2014/012/R*

### **OTHER SURFACES**

Other surfaces associated with the aerodrome are surfaces that need to be established when operating in accordance with ICAO PANS-OPS Doc 8168 (Procedures for Air Navigation Services - Aircraft Operations), Volume II, as adopted into the national law. The term 'surfaces' in this meaning is not used uniformly in different sources of information where also terms 'area' or 'zone' may be used.

## **GM2 ADR.OPS.B.075(a)(1) Safeguarding of aerodromes**

*ED Decision 2014/012/R*

### **OTHER AREAS TO BE MONITORED AND PROTECTED**

Aeronautical communications, navigation and surveillance systems should be established and protected in accordance with the requirements of ICAO Annex 10.

## **ADR.OPS.B.080 Marking and lighting of vehicles and other mobile objects**

*Delegated Regulation (EU) 2020/2148*

- (a) The aerodrome operator shall ensure that vehicles and other mobile objects, excluding aircraft, on the movement area of the aerodrome are:

- (1) marked by use of conspicuous colours, or display, at suitable locations, flags of appropriate size, chequered pattern and contrasting colours;
  - (2) lighted with low-intensity obstacle lights whose type and characteristics are appropriate to their function, if the vehicles and the aerodrome are used at night or in conditions of low visibility. The colour of the lights to be displayed shall be as follows:
    - (i) flashing blue for vehicles associated with emergency or security;
    - (ii) flashing yellow for other vehicles, including follow-me vehicles;
    - (iii) fixed red for objects with limited mobility.
- (b) The aerodrome operator may exempt from point (a) aircraft servicing equipment and vehicles used only on aprons.

## AMC1 ADR.OPS.B.080(a) Marking and lighting of vehicles and other mobile objects

ED Decision 2021/003/R

### MARKING OF VEHICLES

- (a) Vehicles to be marked should be coloured or display flags as follows:
- (1) Red or yellowish green colour should preferably be used for marking emergency vehicles and yellow colour for service vehicles.
  - (2) When flags are used to mark vehicles, they should:
    - (i) be displayed around, on top of, or around the highest edge of the vehicle. Flags should not increase the hazard presented by the vehicle they mark;
    - (ii) not be less than 0.9 m on each side and should consist of a chequered pattern, each square having sides of not less than 0.3 m. The colours of the pattern should contrast each with the other and with the background against which they will be seen. Orange and white, or alternatively red and white should be used, except where such colours merge with the background.

### LIGHTING OF VEHICLES

- (b) Lighting of vehicles should be as follows:
- (1) Low-intensity obstacle lights, Type C, should be displayed on vehicles;
  - (2) Low-intensity obstacle lights, Type C, displayed on vehicles associated with emergency or security should be flashing blue and those displayed on other vehicles should be flashing yellow;
  - (3) Low-intensity obstacle lights, Type D, should be displayed on follow-me vehicles.
- (c) Low-intensity obstacle lights, Types C and D should be in accordance with the specifications contained in Table Q-1, [CS ADR-DSN.U.930](#) and Figure U-1A or U-1B of CS-ADR-DSN, as appropriate.

## AMC2 ADR.OPS.B.080(a) Marking and lighting of vehicles and other mobile objects

*ED Decision 2021/003/R*

### MARKING OF MOBILE OBJECTS OTHER THAN VEHICLES

- (a) Mobile objects, other than vehicles, to be marked should be coloured or display flags as follows:
- (1) When they are marked by colour, conspicuous colours should be used.
  - (2) When they are marked by flags, the flags should:
    - (i) be displayed around, on top of, or around the highest edge of the object. Flags should not increase the hazard presented by the object they mark; and
    - (ii) not be less than 0.9 m on each side and should consist of a chequered pattern, each square having sides of not less than 0.3 m. The colours of the pattern should contrast each with the other and with the background against which they will be seen. Orange and white, or alternatively red and white should be used, except where such colours merge with the background.

### LIGHTING OF MOBILE OBJECTS OTHER THAN VEHICLE

- (b) Lighting of mobile objects, other than vehicles, should be as follows:
- (1) Low-intensity obstacle lights, Type C, should be displayed on mobile objects;
  - (2) Low-intensity obstacle lights on objects with limited mobility, such as aerobridges, shall be fixed-red, and as a minimum be in accordance with the specifications for low-intensity obstacle lights, Type A, in Table Q-1 of CS-ADR-DSN. The intensity of the lights shall be sufficient to ensure conspicuity considering the intensity of the adjacent lights and the general levels of illumination against which they would normally be viewed.

## GM1 ADR.OPS.B.080(a) Marking and lighting of vehicles and other mobile objects

*ED Decision 2021/003/R*

### MOBILE OBJECTS OTHER THAN VEHICLES

The term 'mobile objects' covers all mobile equipment, such as passenger stairs, generators, as well as other similar equipment, which are not self-powered, and whose presence is required on the apron for the ground servicing of aircraft.

It also covers objects of reduced mobility, such as aerobridges, which are attached to the terminal building.

Moreover, it covers any other mobile equipment that may be needed to be used in the manoeuvring area for specific purposes.

## ADR.OPS.B.090 Use of the aerodrome by higher code letter aircraft

*Regulation (EU) No 139/2014*

- (a) Except for aircraft emergency situations, an aerodrome operator may, subject to prior approval by the Competent Authority, permit the use of the aerodrome or parts thereof by aircraft with

a higher code letter than the aerodrome design characteristics specified in the terms of the certificate.

- (b) In showing compliance with point (a), the provisions of [ADR.OR.B.040](#) shall apply.

## AMC1 ADR.OPS.B.090 Use of the aerodrome by higher code letter aircraft

ED Decision 2014/012/R

### ELEMENTS TO BE ASSESSED

When assessing the possibility of operation of aircraft whose code letter is higher than the code letter of the aerodrome reference code, the aerodrome operator should, amongst other issues, assess the impact of the characteristics of the aircraft on the aerodrome, its facilities, equipment and its operation, and vice versa.

Aircraft characteristics to be assessed include, but are not limited to:

- (a) fuselage length;
- (b) fuselage width;
- (c) fuselage height;
- (d) tail height;
- (e) wingspan;
- (f) wing tip vertical clearance;
- (g) cockpit view;
- (h) distance from the pilot's eye position to the nose landing gear and to the main landing gear;
- (i) outer main gear wheel span;
- (j) wheelbase;
- (k) main gear steering system;
- (l) landing gear geometry;
- (m) engine data;
- (n) flight performance; and
- (o) technology evolution.

## GM1 ADR.OPS.B.090 Use of the aerodrome by higher code letter aircraft

ED Decision 2014/012/R

### ELEMENTS TO BE ASSESSED

Further guidance on this issue is contained in ICAO Circular 305-AN/177 and ICAO Circular 301-AN/174.

In any case, the elements that have to be taken into account for the safety assessment are, without prejudice to other assessments that may have to be conducted, in accordance with other applicable requirements contained in Part-ADR.OPS.

Such assessments should include, but are not limited to:

- (a) the aircraft mass, tire pressure and ACN values — with regard to overload operations; and
- (b) maximum passenger and fuel carrying capacity — with regard to level of RFFS protection to be provided and the aerodrome emergency planning.

## SUBPART C — AERODROME MAINTENANCE (ADR.OPS.C)

### ADR.OPS.C.005 Maintenance — General

*Delegated Regulation (EU) 2020/2148*

- (a) The aerodrome operator shall establish and implement a maintenance programme, which includes preventive maintenance where appropriate, to maintain aerodrome facilities, systems and equipment necessary for the operation of the aerodrome in a condition which does not impair the safety, regularity or efficiency of air navigation. The design and implementation of the maintenance programme shall observe human factors principles.
- (b) The aerodrome operator shall ensure that appropriate and adequate means are provided for the effective implementation of the maintenance programme.

### AMC1 ADR.OPS.C.005 General

*ED Decision 2021/003/R*

#### MAINTENANCE PROGRAMME

- (a) The aerodrome operator should ensure that the maintenance programme:
  - (1) specifies the aerodrome facilities, systems, installations and equipment subject to maintenance;
  - (2) contains the necessary information for its timely and correct implementation including but not limited to:
    - (i) the type of inspections/checks to be carried out (e.g. visual inspection, cleaning of equipment, equipment stability/alignment, calibration, etc.) for each facility, system, installation and equipment, taking also into account factors such as their location and meteorological phenomena;
    - (ii) the frequency of inspections/checks for each facility, system, installation and equipment;
    - (iii) the tools and equipment required for each type of inspection/check; and
    - (iv) the periodic replacement of parts that may be required in accordance with the maintenance instructions of the manufacturer of the respective facility, system, installation and equipment, as appropriate.
- (b) The aerodrome operator should ensure that arrangements are in place for timely corrective maintenance actions. Such arrangements should cover the cases of maintenance needs that are:
  - (1) identified either during preventive maintenance activities; or
  - (2) raised at any other time (e.g. due to equipment malfunction or failure).

### GM1 ADR.OPS.C.005 General

*ED Decision 2021/003/R*

#### MAINTENANCE PROGRAMME

The maintenance programme also includes maintenance of communication and alerting systems, fences and access control devices, perimeter roads and lighting, passenger boarding bridges, etc.

## ADR.OPS.C.007 Maintenance of vehicles

*Delegated Regulation (EU) 2020/2148*

- (a) The aerodrome operator shall:
  - (1) establish and implement a maintenance programme, which includes preventive maintenance and observes human factors principles, for rescue and firefighting vehicles, to ensure effectiveness of the vehicles and their equipment and compliance with the specified response time throughout the life of the vehicle;
  - (2) ensure the implementation of a maintenance programme for its other vehicles that operate on the movement area or other operational areas.
- (b) The aerodrome operator shall:
  - (1) establish procedures to support the implementation of the maintenance programme referred to in point (a);
  - (2) ensure that appropriate and adequate means and facilities are provided for its effective implementation;
  - (3) keep maintenance records for each vehicle.
- (c) The aerodrome operator shall ensure that organisations that operate or provide services at the aerodrome:
  - (1) maintain their vehicles that operate on the movement area or other operational areas, in accordance with an established maintenance programme, including preventive maintenance;
  - (2) keep relevant maintenance records.
- (d) The aerodrome operator shall ensure that unserviceable vehicles are not used for operations.

### AMC1 ADR.OPS.C.007(a) Maintenance of vehicles

*ED Decision 2021/003/R*

#### MAINTENANCE OF VEHICLES — GENERAL

The maintenance of the vehicles may be performed by the aerodrome operator or by a contracted organisation. The maintenance programme should be individual for each vehicle, depending on its function and characteristics. The maintenance programme should take into account the following:

- (a) regulatory requirements (e.g. certification of pressure vessels, hoses, roadworthiness certificates);
- (b) the manufacturer's maintenance recommendations;
- (c) local environmental conditions (e.g. heat versus cold winters);
- (d) the need to ensure the serviceability of the equipment installed on the vehicle (e.g. radio, transponders or equivalent systems); and
- (e) regular performance test results, if appropriate.

**AMC1 ADR.OPS.C.007(a)(1) Maintenance of vehicles**

ED Decision 2021/003/R

**PREVENTIVE MAINTENANCE**

- (a) As part of the preventive maintenance programme, the aerodrome operator should determine the items that need to be checked daily, prior to the operation of the vehicle. As a minimum, the following items should be checked on a daily basis, prior to the operation of a vehicle:
- (1) malfunction/warning indications;
  - (2) steering wheel;
  - (3) lighting system;
  - (4) braking system;
  - (5) communication systems, including transponder (or equivalent) if applicable;
  - (6) tyre condition;
  - (7) external mirrors;
  - (8) windscreen wipers (as appropriate);
  - (9) items that need to be secured on the vehicle;
  - (10) leaks; and
  - (11) new external damages to the vehicle.
- (b) A feedback mechanism should be established to ensure that any defects identified are communicated to the unit responsible for the maintenance of the vehicle.

**GM1 ADR.OPS.C.007(a)(2) Maintenance of vehicles**

ED Decision 2021/003/R

As part of the maintenance programme for all its other vehicles, the aerodrome operator may, in the interest of safety, determine the items that need to be checked daily prior to their use, and communicate any defects identified during such checks to the unit responsible for the maintenance of the vehicle.

**AMC1 ADR.OPS.C.007(b)(1) Maintenance of vehicles**

ED Decision 2021/003/R

**MAINTENANCE PROCEDURES — GENERAL**

Maintenance procedures should be established to ensure a standardised manner in which vehicles are maintained and should cover as a minimum:

- (a) activities to be undertaken to ensure that disruption to aerodrome services (e.g. RFFS) is minimised;
- (b) the frequency of maintenance services;
- (c) activities to be undertaken at each type of maintenance service (e.g. visual check, inspections, measurements, etc.);
- (d) arrangements for technical support from the manufacturer;
- (e) spare parts that should be kept on site;



- (f) procedures to ensure the safety of maintenance personnel;
- (g) environmental procedures, including appropriate disposal procedures for old parts, and other material; and
- (h) documentation and reporting of any defects that have been identified by operational and/or maintenance personnel.

## **AMC1 ADR.OPS.C.007(b)(2) Maintenance of vehicles**

*ED Decision 2021/003/R*

### **MAINTENANCE FACILITIES — GENERAL**

If maintenance services and/or facilities are provided by a contracted organisation (located at the aerodrome or elsewhere), the aerodrome operator should have in place arrangements, to allow the timely maintenance of the vehicles in order to avoid disruptions to aerodrome operations.

Irrespective of the solution chosen, the aerodrome operator should ensure:

- (a) the adequacy of the facilities for the maintenance activities and the storage of spare parts and other material;
- (b) the provision of tools and equipment necessary for the maintenance activities, especially for RFFS vehicles and related equipment;
- (c) the availability of maintenance documentation; and
- (d) the provision of appropriate and adequate training to the personnel involved in maintenance activities.

## **AMC1 ADR.OPS.C.007(b)(3) Maintenance of vehicles**

*ED Decision 2021/003/R*

### **MAINTENANCE RECORDS**

The maintenance records, as a minimum, should include the following:

- (a) maintenance type (preventive/corrective);
- (b) items checked/repaired;
- (c) maintenance date (entry/exit date to/from the workshop); and
- (d) name of the person that conducted the inspection/repair.

## **AMC1 ADR.OPS.C.007(c) Maintenance of vehicles**

*ED Decision 2021/003/R*

### **MAINTENANCE OF VEHICLES — OTHER ORGANISATIONS**

The aerodrome operator should establish and implement an audit programme and/or control mechanism that allows ensuring compliance of the organisations operating or providing services at the aerodrome.

A feedback mechanism should be established with the aerodrome unit responsible for authorising the operation of vehicles as per [ADR.OPS.B.026](#), to enable it to take appropriate action.

## AMC2 ADR.OPS.C.007(c) Maintenance of vehicles

ED Decision 2021/003/R

### MAINTENANCE OF VEHICLES — OTHER ORGANISATIONS

- (a) The maintenance programme should be individual for each vehicle, depending on its function and characteristics. The maintenance programme should take into account the following:
- (1) applicable regulatory requirements;
  - (2) the manufacturer's maintenance recommendations;
  - (3) local environmental conditions (e.g. heat versus cold winters);
  - (4) the need to ensure the serviceability of the equipment installed on the vehicle (e.g. radio, transponders); and
  - (5) regular performance test results, if appropriate.
- (b) With regard to maintenance procedures, they should include at least specify:
- (1) the frequency of the maintenance services;
  - (2) activities to be undertaken at each type of maintenance service (e.g. visual check, inspections, etc.); and
  - (3) environmental procedures, including appropriate disposal procedures for old parts and other material.
- (c) With regard to preventive maintenance, [AMC1 ADR.OPS.C.007\(a\)\(1\)](#) applies.
- (d) With regard to record-keeping, [AMC1 ADR.OPS.C.007\(b\)\(3\)](#) applies.

## GM1 ADR.OPS.C.007(d) Maintenance of vehicles

ED Decision 2021/003/R

### UNINTENDED USE OF UNSERVICEABLE VEHICLES

Apart from the obligation to ensure that an unserviceable vehicle is removed from operations, measures also need to be taken to avoid the unintended use of an unserviceable vehicle. The latter may include the placing of a warning placard inside the vehicle to inform about the unserviceability of the vehicle, and the establishment of a method for the provision of such information to the relevant personnel, especially those of the next shift.

## ADR.OPS.C.010 Maintenance of pavements, other ground surfaces and drainage

Delegated Regulation (EU) 2020/2148

- (a) The aerodrome operator shall inspect the surfaces of all movement areas including pavements (runways, taxiways and aprons), adjacent areas and drainage to regularly assess their condition as part of an aerodrome preventive and corrective maintenance programme.
- (b) The aerodrome operator shall:
- (1) maintain the surfaces of all movement areas with the objective of avoiding and eliminating any FOD that might cause damage to aircraft or impair the operation of aircraft systems;

- (2) maintain the surface of runways, taxiways and aprons in order to prevent the formation of harmful irregularities;
- (3) maintain the runway in a condition so as to provide surface friction characteristics at or above the minimum standards;
- (4) periodically inspect and document the runway surface friction characteristics for maintenance purposes. The frequency of those inspections shall be sufficient to determine the trend of the surface friction characteristics of the runway;
- (5) take corrective maintenance action to prevent the runway surface friction characteristics for either the entire runway or a portion thereof, when uncontaminated, from falling below the minimum standards.

## AMC1 ADR.OPS.C.010 Maintenance of pavements, other ground surfaces and drainage

*ED Decision 2021/003/R*

### GENERAL

- (a) Mud, dust, sand, oil, rubber deposits, and other pollutants should be removed, as rapidly and completely as possible, to minimise accumulation.
- (b) Taxiways and aprons should be kept clear of pollutants to the extent necessary to enable aircraft to be taxied to and from an operational runway.
- (c) Drainage systems and storm water collection systems should be periodically checked and, if necessary cleaned or maintained, to ensure efficient water run-off.
- (d) The surface of a paved runway should be evaluated when constructed or resurfaced to determine that the surface friction characteristics achieve the design objectives.

## GM1 ADR.OPS.C.010(b)(1) Pavements, other ground surfaces, and drainage

*ED Decision 2021/003/R*

### OVERLOAD OPERATIONS

- (a) Overloading of pavements can result either from loads too large, or from a substantially increased application rate, or both. Loads larger than the defined (design or evaluation) load shorten the design life, whilst smaller loads extend it. With the exception of massive overloading, pavements in their structural behaviour are not subject to a particular limiting load above which they suddenly or catastrophically fail. Behaviour is such that a pavement can sustain a definable load for an expected number of repetitions during its design life. As a result, occasional minor overloading is acceptable, when expedient, with only limited loss in pavement life expectancy, and relatively small acceleration of pavement deterioration. For those operations in which magnitude of overload and/or the frequency of use do not justify a detailed analysis, the following criteria are suggested:
  - (1) for flexible pavements, occasional movements by aircraft with ACN not exceeding 10 % above the reported PCN should not adversely affect the pavement;
  - (2) for rigid or composite pavements, in which a rigid pavement layer provides a primary element of the structure, occasional movements by aircraft with ACN not exceeding 5 % above the reported PCN should not adversely affect the pavement;

- (3) if the pavement structure is unknown, the 5 % limitation should apply; and
  - (4) the annual number of overload movements should not exceed approximately 5 % of the total annual aircraft movements.
- (b) Such overload movements should not normally be permitted on pavements exhibiting signs of distress or failure. Furthermore, overloading should be avoided during any periods of thaw following frost penetration, or when the strength of the pavement or its subgrade could be weakened by water. Where overload operations are conducted, the aerodrome operator should review the relevant pavement condition regularly, and should also review the criteria for overload operations periodically since excessive repetition of overloads can cause severe shortening of pavement life, or require major rehabilitation of pavement.

## GM1 ADR.OPS.C.010(b)(2) Pavements, other ground surfaces and drainage

*ED Decision 2021/003/R*

### RUNWAY SURFACE EVENNESS

- (a) The operation of aircraft and differential settlement of surface foundations will eventually lead to increases in surface irregularities. Small deviations in the above tolerances will not seriously hamper aircraft operations. In general, isolated irregularities of the order of 2.5 cm to 3 cm over a 45 m-distance are acceptable, as shown in Figure 1. Although maximum acceptable deviations vary with the type and speed of an aircraft, the limits of acceptable surface irregularities can be estimated to a reasonable extent. The following table describes acceptable, tolerable and excessive limits:

Surface Irregularity	Length of irregularity (m)								
	3	6	9	12	15	20	30	45	60
Acceptable surface irregularity height (cm)	2.9	3.8	4.5	5	5.4	5.9	6.5	8.5	10
Tolerable surface irregularity height (cm)	3.9	5.5	6.8	7.8	8.6	9.6	11	13.6	16
Excessive surface irregularity height (cm)	5.8	7.6	9.1	10	10.8	11.9	13.9	17	20

**Table 1**

- (1) If the surface irregularities exceed the heights defined by the acceptable limit curve but are less than the heights defined by the tolerable limit curve, at the specified minimum acceptable length, herein noted by the tolerable region, then maintenance action should be planned. The runway may remain in service. This region is the start of possible passenger and pilot discomfort.
- (2) If the surface irregularities exceed the heights defined by the tolerable limit curve, but are less than the heights defined by the excessive limit curve, at the specified minimum acceptable length, herein noted by the excessive region, the maintenance corrective action is mandatory to restore the condition to the acceptable region. The runway may remain in service but should be repaired within a reasonable period. This region could lead to the risk of possible aircraft structural damage due to a single event or fatigue failure over time.
- (3) If the surface irregularities exceed the heights defined by the excessive limit curve, at the specified minimum acceptable length, herein noted by the unacceptable region, then the

area of the runway where the roughness has been identified warrants closure. Repairs are required to restore the condition within the acceptable limit region and the aircraft operators may be advised accordingly. This region runs the extreme risk of a structural failure and must be addressed immediately.

- (b) The term ‘surface irregularity’ is defined herein to mean isolated surface elevation deviations that do not lie along a uniform slope through any given section of a runway. For the purposes of this concern, a ‘section of a runway’ is defined herein to mean a segment of a runway throughout which a continuing general uphill, downhill, or flat slope is prevalent. The length of this section is generally between 30 and 60 m, and can be greater, depending on the longitudinal profile and the condition of the pavement.
- (c) The maximum tolerable step-type bump, such as that which could exist between adjacent slabs, is simply the bump height corresponding to zero bump length at the upper end of the tolerable region of the roughness criteria of Figure 1.
- (d) Deformation of the runway with time may also increase the possibility of the formation of water pools. Pools as shallow as approximately 3 mm in depth, particularly if they are located where they are likely to be encountered at high speed by landing aeroplanes, can induce aquaplaning which can then be sustained on a wet runway by a much shallower depth of water. Improved guidance regarding the significant length and depth of pools relative to aquaplaning is the subject of further research. It is, of course, especially necessary to prevent pools from forming whenever there is a possibility that they might become frozen.
- (e) Macrotexture and microtexture are taken into consideration in order to provide the required surface friction characteristics. This normally requires some form of special surface treatment.

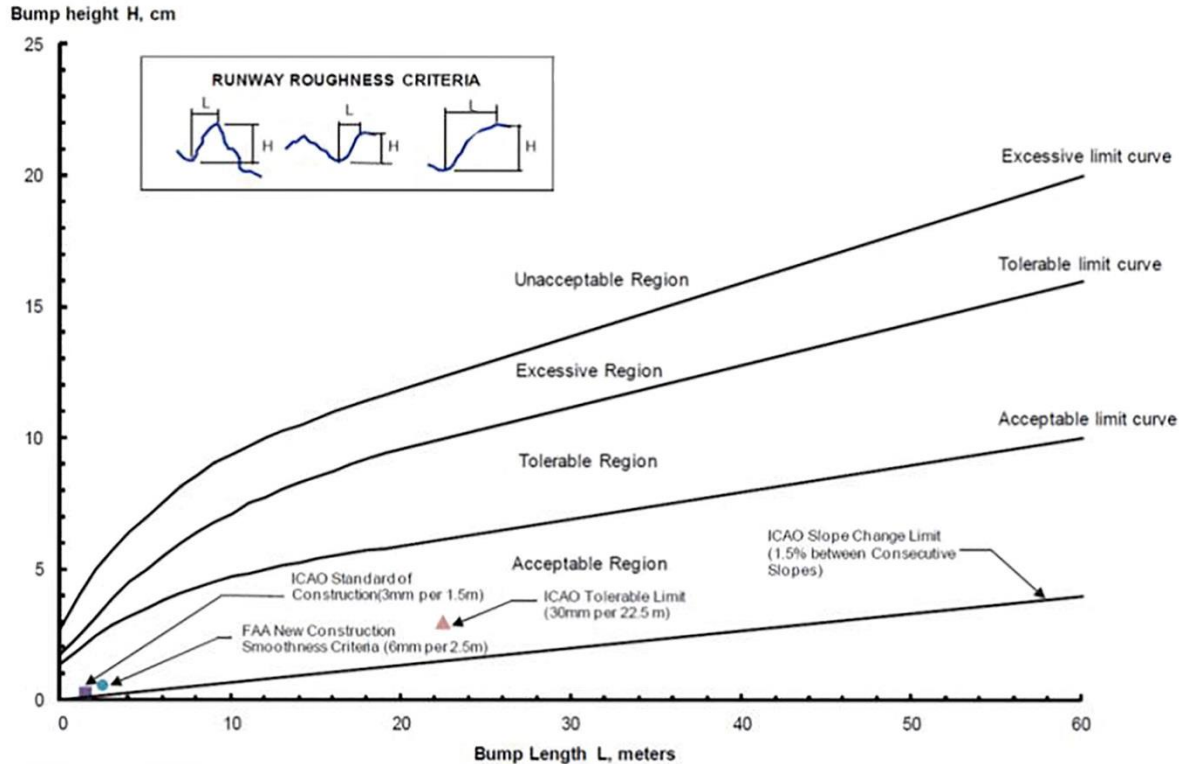


Figure 1

## AMC1 ADR.OPS.C.010(b)(3) Maintenance of pavements, other ground surfaces and drainage

*ED Decision 2021/003/R*

### MAINTENANCE PLANNING AND MINIMUM STANDARDS

- (a) When friction measuring devices are used in order to evaluate the condition of the runway surface for maintenance purposes, the maintenance planning and minimum friction levels should be according to the following table:

	65 km/h		95 km/h	
	Minimum	Maintenance planning	Minimum	Maintenance planning
Airport Surface Friction Tester	0.50	0.60	0.34	0.47
Dynatest Consulting Inc. Dynatest Runway Friction Tester	0.50	0.60	0.41	0.54
Findlay, Irvine, Ltd Griptester Friction Meter	0.43	0.53	0.24	0.36
Halliday Technologies RT3	0.45	0.55	0.42	0.52
Moventor Oy Inc. BV-11 Skiddometer	0.50	0.60	0.34	0.47
Mu Meter	0.42	0.52	0.26	0.38
NAC Dynamic Friction Tester	0.42	0.52	0.28	0.38
Norsemeter RUNAR (operated at fixed 16 % slip)	0.45	0.52	0.32	0.42
Automatic Friction Measuring Device (Instrument de Mesure Automatique de Glissance) – IMAG	0.30	0.40	0.20	0.30

**Table 1**

- (b) Other friction measuring devices can be used, provided they have been correlated with, at least, one test equipment mentioned in the table above.
- (c) Measurements at or below the maintenance planning level trigger a complete survey of the texture, contaminant and drainage state of the affected runway third.
- (d) A complete survey should ensure that the runway surface is able to create enough grip by the aeroplane tyre to ensure adequate aeroplane stopping and crosswind capability for the desired operation on a wet runway. This is achieved by ensuring that:
- (1) exposed texture can indent the tyre rubber; and
  - (2) water drains from the runway pavement.
- (e) In order to achieve the objectives of point (d), an inspection of the surface friction characteristics should, as a minimum, ensure:
- (1) the presence of exposed microtexture by touching the aggregates, if the polished or rubber coated extends to 100 m in the zone used by aeroplanes;

- (2) the presence of macrotexture;
- (3) that grooves, if present, are open and within set limits according to their design;
- (4) that porous friction course, if present, drains according to its design; and
- (5) that slopes are above minimum design specifications.

## GM1 ADR.OPS.C.010(b)(3) Pavements, other ground surfaces and drainage

*ED Decision 2021/003/R*

### MONITORING OF PHYSICAL PARAMETERS

The following table describes how the physical parameters of the runway surface are monitored.

Physical parameter	How to monitor
Microtexture	Presence of microtexture is ensured by touching the pavement surface. If it feels smooth, there is a lack of microtexture, most commonly due to rubber deposits which normally should be visually detectable or by polishing. In either case, the amount of free exposed microtexture should be assessed.
Macrotexture	Can be measured using volumetric or profile measurement method and expressed by ESDU classification. ESDU 15002 groups runways into five classifications labelled A through E with A being the smoothest and E the most heavily textured. The classification can be used to compare the runway texture relevant to the recommended texture depth which is 1.0 mm.
Drainage	Slopes are within the certification specifications. If the slope falls below the minimum values, then the runway becomes more susceptible to standing water during heavy rainfalls.
Ponding	Visually, during and after rain storm events as the runway dries up.
Rutting	Visually, during and after rain storm events. The degree of rutting can be measured using a straight edge.
Sand and vegetation	Visually during and after rain storm events. Normally, ordinary maintenance activities should prevent sand to accumulate and vegetation to form alongside the runway to such a degree that it becomes a hazard.

## AMC1 ADR.OPS.C.010(b)(4) Maintenance of pavements, other ground surfaces and drainage

*ED Decision 2021/003/R*

### PERIODIC ASSESSMENTS OF RUNWAY SURFACE FRICTION CHARACTERISTICS

The aerodrome operator when establishing a plan of periodic assessments of runway surface friction characteristics, should take into consideration the number of jet aircraft movements per runway end, the weight of the aircraft, the type and age of the surface of the runway as well as climatic conditions.

## AMC2 ADR.OPS.C.010(b)(4) Maintenance of pavements, other ground surfaces and drainage

ED Decision 2021/003/R

### TREND MONITORING OF RUNWAY SURFACE FRICTION CHARACTERISTICS

The aerodrome operator should monitor the trend of degradation of runway surface friction characteristics that is caused by:

- (a) rubber deposits;
- (b) surface polishing; and
- (c) poor drainage.

## AMC3 ADR.OPS.C.010(b)(4) Maintenance of pavements, other ground surfaces and drainage

ED Decision 2021/003/R

### FUNCTIONAL FRICTION EVALUATIONS WITH CONTINUOUS FRICTION MEASURING DEVICES

The aerodrome operator when conducting functional friction evaluations with continuous friction measuring device, should:

- (a) for friction evaluations on runways at 65 km/h, begin recording the data 150 m from the threshold end to allow for adequate acceleration distance and terminate approximately 150 m from the opposite end of the runway to allow for adequate distance to safely decelerate the vehicle;
- (b) for friction evaluations on runways at 95 km/h, begin recording the data 300 m from the threshold end to allow for adequate acceleration distance and terminate approximately 300 m from the opposite end of the runway to allow for adequate distance to safely decelerate the vehicle; and
- (c) conduct the surveys at a distance from the runway centre line that is representative of the wheel span of the aeroplanes operating on the runway.

The aerodrome layout or other circumstances may dictate other distances in order to ensure the personal safety of the operator of the friction measuring device.

## AMC4 ADR.OPS.C.010(b)(4) Maintenance of pavements, other ground surfaces and drainage

ED Decision 2021/003/R

### RUNWAY SURFACE FRICTION CHARACTERISTICS EVALUATION WITHOUT FRICTION MEASURING DEVICES

- (a) The evaluation should be conducted for the full width and length of the pavement and should focus on:
  - (1) slopes;
  - (2) texture; and
  - (3) drainage.
- (b) The area symmetrical from the centre line representative of the wheel span of the aeroplanes operating on the runway should be inspected with special focus on:



- (1) rubber deposits;
- (2) polishing of aggregates; and
- (3) amount of exposed texture.

## **GM1 ADR.OPS.C.010(b)(4) Maintenance of pavements, other ground surfaces and drainage**

*ED Decision 2021/003/R*

### **TREND MONITORING PROGRAMME**

- (a) The objective of the trend monitoring programme is to ensure that the surface friction characteristics for the entire runway remain at or above the minimum standards, to avoid the runway becoming slippery wet.
- (b) Degradation is typically caused by rubber deposits, surface polishing or poor drainage. These can be mitigated as follows:
  - (1) Accumulation trend of rubber can be managed through a rubber removal programme.
  - (2) Polishing trend of the surface can be managed by monitoring loss of sharpness and retexturing/resurfacing programme.
  - (3) Drainage trend can be managed by monitoring changes in geometry and blocking of drainage channels and reshaping programme.
- (c) In the construction of new runways or the resurfacing of existing runways, the construction of surfaces with adequate slopes and aggregate of angular fragments from crushed gravel or stone so as to provide a sharp texture will help to ensure surface friction characteristics providing good braking action in wet conditions. The surface friction characteristics of a new constructed or resurfaced runway surface establish the normal starting point for trend monitoring; however, trend monitoring can also start at any given time through the lifespan of a pavement.
- (d) The determination that a runway or portion thereof is slippery wet stems from various methods used by themselves or in combination. Additionally, substandard runways or portion thereof can be identified through repeated reports by aeroplane operators based upon flight crew experience or through analysis of aeroplane stopping performance. When such reports are received, it is an indication that the surface friction characteristics are likely to be severely degraded and immediate remedial action is necessary.

## **GM2 ADR.OPS.C.010(b)(4) Maintenance of pavements, other ground surfaces and drainage**

*ED Decision 2021/003/R*

### **FRICTION EVALUATIONS WITH CONTINUOUS FRICTION MEASURING DEVICES**

- (a) The lateral location on the runway for performing friction measurements is based on the type and/or mix of aircraft operating on the runway:
  - (1) For runways serving only narrow-body aircraft, friction measurements are conducted 3 m to 5 m from the runway centre line.
  - (2) For runways serving narrow-body and wide-body aircraft, friction measurements are conducted 3 m and 6 m from the runway centre line to determine the worst-case condition. If the worst-case condition is found to be consistently to one track, future

measurements may be limited to this track. Care needs to be exercised, however, to account for any future and/or seasonal changes in aircraft mix.

- (b) The measurements are performed using a self-wetting continuous friction measuring device on a dry runway surface.
- (c) Interpretation of comparative self-wetting friction measurements
  - (1) The texture of the tyre pavement contact patch area in direct contact with aircraft tyre penetrates the rubber of the aircraft tyre and creates horizontal forces in the aircraft tyre and creates grip. Grip is a micro-movement of the rubber over the texture indenting the rubber. This micro-movement is called slippage. On a free-rolling aircraft tyre, there is no relative movement between the aircraft tyre and the pavement regardless of the rolling speed. The amount of exposed texture, and the quality thereof, both micro and macrotecture, defines the ability of the pavement surface to create wet grip performance of the aircraft tyre.
  - (2) If the aircraft wheel is braked and the horizontal forces applied on the aircraft tyre are higher than those produced by the grip, the aircraft tyre starts to skid.
  - (3) The friction coefficient that can be calculated is a dynamic friction coefficient. The dynamic friction coefficient is lower than the static friction coefficient (maximum tyre grip that can be achieved). Related to stopping performance of the aircraft, the operation has become friction-limited when a tyre starts skidding.
  - (4) The basic assumption for the using a self-wetting continuous friction measuring device with a forced skid is to mirror a braked skidding aircraft tyre on a wet pavement surface. This is an oversimplification since the aircraft tyres are controlled by an anti-skid system and the friction measuring devices operate at a fixed slip.
  - (5) It is noted that friction measuring device values are not used to determine and report surface conditions. Joint industry and multi-national government tests have not established a reliable correlation between runway friction values and the relationship to aeroplane braking performance. However, the measured values can be used in a comparative way to support other survey information collected.
  - (6) The measured friction coefficient is a dynamic friction coefficient where the surfaces are forced to be in relative motion regardless of the measuring speed. The degree of relative motion is friction measuring device-specific.
  - (7) A complete survey is, as a minimum, performed at speeds of 65 km/h and 95 km/h.
  - (8) The measured value is an indication of the overall texture, contaminant and drainage capability of the pavement surface in the tyre pavement contact patch area of a skidding tyre. No single capability can be extracted but certain qualities can be deduced from comparative measurements using the same friction measurement device on the same surface.
  - (9) The measured values are to be compared with measured values from previous surveys in order to monitor the trend of the texture, contaminant and drainage characteristics of the runway pavement.
    - (i) Texture
      - (A) At low speed, the microtexture of the aggregates in the tyre pavement contact patch area penetrates the residual water film between the pavement and the rubber. These are qualities associated with 65 km/h.

Lower comparative values at low speed indicate reduced exposed microtexture and are indicative of microtexture cover-up (rubber) and polishing of aggregates.

- (B) At higher speed, the microtexture may not penetrate the residual water film. As speed increases, the residual water film may become thicker and reduce the amount of microtexture that penetrates the water film. If no microtexture penetrates the water film, there is no effect of the microtexture on the performance of the aircraft tyre. The tyre then goes into an aquaplaning mode with no stopping and directional control capability. These are qualities associated with 95 km/h, and lower comparative values are indicative of the combined rubber build-up and reduced drainage capability.
- (C) Macrottexture creates escape channels for bulk water and reduces the susceptibility of the pavement surface to build up water films under the aircraft tyre. Lower comparative values at high speed indicate reduced macrottexture.

(ii) Contaminant

- (A) The most common contaminant to consider is the build-up of rubber. Build-up of rubber reduces the amount of exposed microtexture and the fill-up of the macrottexture, and thereby reduces the drainage capability of the pavement in the tyre pavement contact patch area. Affected areas can readily be identified by the eye.
- (B) If the aerodrome operator suspects that the runway has a microtexture problem, this can be identified by the touch; pavement surface does feel 'sandpapery'. This applies to both rubber build-up, where the aggregates get covered, and the polishing of aggregates.
- (C) For interpretation of comparative measurements on rubber built-up areas, see (i) *Texture* above.

(10) Drainage

- (i) The aircraft tyres' contribution to drainage is the drainage through the longitudinal grooves. The pavements' contribution is the drainage through their macrottexture. This drainage can be in all directions, and in the case of porous friction course drainage downwards, through the porous friction course layer itself. If the pavement is transverse grooved, the drainage in the transverse direction of travel is enhanced. Lower comparative values at high speed indicate reduced drainage capability under the aircraft tyre and reduced macrottexture.
- (ii) It should be noted that the effects of drainage defects, such as ponding and rutting, will not be detected by comparative measurements by self-wetting continuous friction measuring devices. As the self-wetting continuous friction measurements are performed on a dry runway, there will be no ponding, nor any water stream in any rutting if the runway has such defects.

## **ADR.OPS.C.015 Maintenance of visual aids and electrical systems**

*Delegated Regulation (EU) 2020/2148*

- (a) The aerodrome operator shall establish and implement a preventive and corrective maintenance programme to ensure the serviceability of the electrical systems and the availability of power supply to all necessary facilities of the aerodrome, in a manner that ensures the safety, regularity and efficiency of air navigation.
- (b) The aerodrome operator shall establish and implement a preventive and corrective maintenance programme to ensure the serviceability of the individual lights and the aerodrome's lighting systems reliability, in a manner that ensures continuity of guidance to, and control of aircraft and vehicles, as follows:
  - (1) For a precision approach runway Category II or III, the system of preventive maintenance shall have as its objective that, during any period of Category II or III operations, all approach and runway lights are serviceable and that, in any event, at least:
    - (i) 95 % of the lights are serviceable in each of the following elements:
      - (A) precision approach Category II and III lighting system, the inner 450 m;
      - (B) runway centre line lights;
      - (C) runway threshold lights;
      - (D) runway edge lights.
    - (ii) 90 % of the lights are serviceable in the touchdown zone lights;
    - (iii) 85 % of the lights are serviceable in the approach lighting system beyond 450 m;
    - (iv) 75 % of the lights are serviceable in the runway-end lights.
  - (2) The lights that may be unserviceable in accordance with point (1) shall not alter the basic pattern of the lighting system.
  - (3) An unserviceable light shall not be permitted adjacent to another unserviceable light, except in a barrette or a crossbar where two adjacent unserviceable lights may be permitted.
  - (4) For a stop bar that is provided at a runway-holding position and is used in conjunction with a runway intended for operations in runway visual range conditions less than a value of 550 m, the system of preventive maintenance shall have the following objectives:
    - (i) no more than two lights shall remain unserviceable;
    - (ii) two adjacent lights shall not remain unserviceable unless the light spacing is significantly less than that required.
  - (5) For a taxiway intended for use in runway visual range conditions less than a value of 550 m, the system of preventive maintenance shall have as its objective that no two adjacent taxiway centre line lights be unserviceable.
  - (6) For a precision approach runway Category I, the system of preventive maintenance employed shall have as its objective that, during any period of Category I operations, all approach and runway lights are serviceable and that, in any event:
    - (i) at least 85 % of the lights are serviceable in each of the following:
      - (A) precision approach Category I lighting system;

- (B) runway threshold lights;
    - (C) runway edge lights;
    - (D) runway-end lights;
  - (ii) an unserviceable light shall not be permitted adjacent to another unserviceable light unless the light spacing is significantly less than that required.
- (7) For a runway meant for take-off in runway visual range conditions less than a value of 550 m, the system of preventive maintenance shall have as its objective that, during any period of operations, all runway lights are serviceable, and that, in any event:
- (i) at least:
    - (A) 95 % of the lights are serviceable in the runway centre line lights (where provided) and in the runway edge lights;
    - (B) 75 % of the lights are serviceable in the runway-end lights;
  - (ii) an unserviceable light shall not be permitted adjacent to another unserviceable light.
- (8) For a runway meant for take-off in runway visual range conditions of a value of 550 m or greater, the system of preventive maintenance shall have as its objective that, during any period of operations, all runway lights are serviceable, and that, in any event:
- (i) at least 85 % of the lights are serviceable in the runway edge lights and runway-end lights;
  - (ii) an unserviceable light shall not be permitted adjacent to another unserviceable light.
- (9) For a runway equipped with visual approach slope indicator systems, the system of preventive maintenance shall have as its objective that, during any period of operations, all units are serviceable. A unit shall be considered unserviceable if the number of unserviceable lights is such that the unit does not provide the intended guidance to the aircraft.
- (c) For the purposes of point (b), a light shall be deemed to be unserviceable if:
- (1) the main beam average intensity is less than 50 % of the value specified in the certification specifications issued by the Agency. For light units where the designed main beam average intensity is above the value specified in the certification specifications issued by the Agency, the 50 % value shall be related to that design value;
  - (2) the filter associated with the light is missing, damaged, or the light does not produce the correct colour light beam.
- (d) The aerodrome operator shall establish and implement a preventive and corrective maintenance programme to ensure the serviceability and reliability of the system of markings and signs of the aerodrome, in a manner that ensures continuity of guidance to, and control of aircraft and vehicles.
- (e) Construction or maintenance activities shall not take place in the proximity of aerodrome electrical systems when low-visibility procedures are in effect at the aerodrome.

- (f) The aerodrome operator shall ensure that:
- (1) the preventive maintenance programmes referred to in points (a), (b) and (d) include appropriate inspections and checks of the individual elements of each system, and of the system itself, which are conducted in accordance with established procedures, and at defined intervals, appropriate to the intended operation and system;
  - (2) appropriate corrective actions are taken to rectify any identified defects.
- (g) The aerodrome operator shall maintain records of the relevant maintenance activities.

## **AMC1 ADR.OPS.C.015(a);(f) Maintenance of visual aids and electrical systems**

*ED Decision 2021/003/R*

### **ELECTRICAL SYSTEMS**

- (a) Schedules of routine maintenance of the individual elements of the aerodrome's electrical systems should be based on manufacturers' instructions, adjusted to the aerodrome operator's experience regarding the frequency of malfunctions.
- (b) The maintenance programme should, as a minimum, include the following:
- (1) power cables and distributors in field;
  - (2) transformers and regulators;
  - (3) transformer stations for electric power supply;
  - (4) relay and switch cabinets;
  - (5) control cables, monitoring units and control desk;
  - (6) secondary power supply; and
  - (7) fixed ground power supply for aircraft,
- and should contain the frequency of the scheduled maintenance activities and the elements that should be checked during each inspection.
- (c) Checklists to be used during the scheduled maintenance activities should be developed by the aerodrome operator.
- (d) The relevant procedures should cover the maintenance activities for each area, including the way such activities should be implemented.

## **GM1 ADR.OPS.C.015(a);(f) Maintenance of visual aids and electrical systems**

*ED Decision 2021/003/R*

### **ELECTRICAL SYSTEMS**

The serviceability and reliability of air navigation equipment and installations are prerequisites for the safe operation of aircraft in the aerodrome area, but also for the regularity and efficiency of the air transportation system.

The required serviceability of installations and equipment can only be achieved if constant power supply is ensured.

To this end, regular maintenance work is required for aerodrome equipment and installations distributing primary power and equipment supplying the secondary power when there is such a need.

Special attention needs to be given to cases where there is interconnection between the electrical systems of the various components of the aerodrome (e.g. terminal building with lighting systems etc.).

Further guidance on the issue may be found in Chapter 3 of Part 9 ‘Airport Maintenance Practices’ of ICAO Doc 9137 ‘Airport Services Manual’.

## GM2 ADR.OPS.C.015(a);(f) Maintenance of visual aids and electrical systems

*ED Decision 2021/003/R*

### ELECTRICAL SYSTEMS

Electrical systems, and parts thereof, may also be subject to certain requirements (e.g. national) which address elements or aspects that do not fall within the scope of the requirements contained in [Regulation \(EU\) No 139/2014](#). Such requirements should not be neglected when determining the maintenance programme.

## GM1 ADR.OPS.C.015(b) Maintenance of visual aids and electrical systems

*ED Decision 2021/003/R*

### LIGHTING SYSTEMS — ALLOWABLE PERCENTAGES OF SERVICEABLE LIGHTS

The allowable percentages of serviceable lights are shown in Table 1 below.

Light type	CAT II/III approach	CAT I approach	RVR<550 m take-off	RVR>550 m take-off
Approach inner 450 m	95 %	85 %	-	-
Approach outer 450 m	85 %	85 %	-	-
Runway threshold	95 %	85 %	-	-
Runway centre line	95 %	85 %	95 %	85 %
Runway edge	95 %	85 %	95 %	85 %
Runway end	75 %	85 %	75 %	85 %
Touchdown zone	90 %	(85 %) <sup>a</sup>	-	-

*Note (a): If touchdown zone lights are available.*

*Note (b): The table covers only the lighting systems for which the requirement provides for a percentage.*

**Table 1: Allowable percentages of serviceable lights**

## GM2 ADR.OPS.C.015(b) Maintenance of visual aids and electrical systems

ED Decision 2021/003/R

### LED LIGHTS — MAINTENANCE PROGRAMME — ICING AND SNOWING CONDITIONS

- (a) The energy savings of light emitting diodes (LEDs) are due in large part to the fact that they do not produce the infrared heat signature of incandescent lamps.

Thus, operators of aerodromes with presence of ice or snow, who have come to expect their melting by this heat signature, need to evaluate whether or not a modified maintenance schedule is required during such conditions, or evaluate the possible operational value of installing LED fixtures with heating elements. Manufacturers can provide a heater, sometimes referred to as an ‘arctic kit’, for their LED light units. Whether a heater is needed is dependent upon the site location and the weather conditions to which it is exposed. In some instances, the low-operating temperature is an advantage in that drifting snow does not melt and attach itself to the fixture lens. It is likely that LED PAPI will require some form of lens heater regardless of site location to ensure that condensation/icing does not occur.

- (b) While LEDs could last for many thousands of hours under certain conditions, the life of the LED itself, and more importantly, that of the complete luminaire including the electronics, still depends on the system integration and the actual conditions in which the luminaire is used. Application conditions that could have an impact on the expected life of the luminaire include, primarily, the temperature of operation, on-off cycling patterns and humidity. Because LEDs do not have filaments that break or deteriorate, when operated under normal conditions, they tend to last for a long time. However, their light output decreases and the colour of their light shifts over time, with the rate of depreciation increasing at higher-operating temperatures. The implication for practice is that at some point in time the loss of light output or the colour shift may render the LED source outside the specifications for a given application or purpose; while the LEDs may technically still be operating, they would no longer be considered useful.

Therefore, the long life of the LED in comparison to that of an incandescent lamp may not be taken as a reason for ‘install and forget’. A system of preventive maintenance is necessary as the LED light does eventually fail. In addition, there are other factors that can reduce performance, such as contamination on the lens of in-pavement fixtures.

## GM3 ADR.OPS.C.015(b) Maintenance of visual aids and electrical systems

ED Decision 2021/003/R

### LIGHTING SYSTEMS — SERVICEABILITY LEVELS

Serviceability levels are intended to define the maintenance performance level objectives.

With respect to barrettes, crossbars and runway edge lights, lights are considered adjacent if located consecutively and:

- (a) laterally: in the same barrette or crossbar; or  
(b) longitudinally: in the same row of edge lights or barrettes.

In barrettes and crossbars, guidance is not lost by having two adjacent unserviceable lights.

Further guidance on the development of preventive maintenance programme of lights is given in Chapter 2 of Part 9 ‘Airport Maintenance Practices’ of ICAO Doc 9137 ‘Airport Services Manual’.



## GM1 ADR.OPS.C.015(b);(c) Maintenance of visual aids and electrical systems

*ED Decision 2021/003/R*

### UNSERVICEABLE LIGHTS

CS ADR-DSN.U.940 'Aeronautical ground light characteristics' contains the figures for determining the unserviceability of individual lights.

The aerodrome operator needs, however, to consider defining, as part of its maintenance programme, two levels of intensity for individual lights, i.e. a maintenance level and the unserviceability level.

The higher level gives aerodrome maintenance personnel advance warning that a light unit is beginning to produce an output significantly below the required value. This level is always above 50 per cent of the specified intensity, which is the level at which the light is classified as being outside specification tolerance and therefore to have failed from an operational perspective. Once the light output reaches the maintenance level, corrective action can be scheduled. This prevents lights from losing performance to the level where immediate maintenance action must be taken.

## AMC1 ADR.OPS.C.015(b);(f) Maintenance of visual aids and electrical systems

*ED Decision 2021/003/R*

### LIGHTING SYSTEMS

#### GROUND CHECKS

- (a) As part of the maintenance programme, the lighting system maintenance activities should include ground checks. During the daily checks, the lighting systems should be checked at least for light failures, breakage or gross misalignment and correct operation of the intensity control system.

The maintenance programme should identify the frequency of other checks that need to be performed throughout the year, as well as their content. Moreover, irrespective of the runway type, the aerodrome operator should ensure the serviceability of the lights by conducting photometric measurements, at appropriate intervals, as part of the maintenance programme.

- (b) Ground checks of visual approach slope indicator systems (VASIS) should determine their alignment and serviceability. The alignment of VASIS should be checked at defined intervals, taking into account environmental conditions (e.g. rain, drought, etc.) that may affect the stability of the system, using an appropriate intensity setting. Additional checks should be conducted following an aircraft occurrence. Errors in excess of one minute of arc should be corrected. The maintenance programme should also cover the obstacle protection surface of the VASIS to ensure that it is clear of all obstacles.

The serviceability of VASIS should be checked on each runway inspection. With regard to serviceability of the precision approach path indicator (PAPI) and abbreviated precision approach path indicator (APAPI), a unit should be considered to be unserviceable if more than one light is unserviceable and the unit consists of three or more lights; or at least one light is unserviceable and the unit consists of less than three lights. In addition, whenever a red filter does not produce the correct colour light beam, is missing, or is damaged, all the lights associated with that filter should be extinguished until the red filter is rectified.

- (c) For a precision approach runway category II or III:
- (1) The system of preventive maintenance employed should include at least the following checks:
    - (i) visual inspection and in-field measurement of the intensity, beam spread and orientation of lights included in the approach and runway lighting systems;
    - (ii) control and measurement of the electrical characteristics of each circuitry included in the approach and runway lighting systems; and
    - (iii) control of the correct functioning of light intensity settings used by air traffic control.
  - (2) In-field measurement of intensity, beam spread and orientation of lights included in approach and runway lighting systems should be undertaken by measuring all lights, as far as practicable, to ensure conformance with the appropriate figure in [CS ADR-DSN.U.940](#).
  - (3) Measurement of intensity, beam spread and orientation of lights included in approach and runway lighting systems should be undertaken using an appropriate measuring unit of sufficient accuracy to analyse the characteristics of the individual lights.
  - (4) The frequency of measurement should be based on traffic density, the local pollution level, the reliability of the installed lighting equipment and the continuous assessment of the results of the in-field measurements but, in any event, should not be less than twice a year for in-pavement lights and not less than once a year for other lights.

#### FLIGHT CHECKS

- (d) As part of the maintenance programme of the lighting systems, flight check of the approach, runway and taxiway lighting systems, VASIS, aerodrome beacon, and the light intensity control system should be carried out at regular intervals, at least on a yearly basis, to ensure that the pattern is correct and that lights are operating properly. Special flight checks should be arranged in case of major maintenance of, or changes to, such systems, as well as before the commissioning of new systems, both at day and night.

## GM1 ADR.OPS.C.015(b);(f) Maintenance of visual aids and electrical systems

ED Decision 2021/003/R

#### LIGHTING SYSTEMS

##### GROUND CHECKS — GENERAL

The ground checks of the lighting system includes a set of different actions that would need to be undertaken at different intervals. These checks include but are not limited to the following:

- (a) broken lights or parts of the unit;
- (b) condition of filters;
- (c) corrosion;
- (d) cleanness;
- (e) tightening of fasteners of units;
- (f) alignment of lights;

- (g) presence of moisture/water;
- (h) electrical connections of lights; and
- (i) condition of structure and the foundation of each unit.

#### GROUND CHECKS —VASIS

VASIS are used in order to provide correct visual glide slope indication to the flight crews in all variable weather conditions, by day and by night. It is therefore imperative that the maintenance programme ensures the correct alignment of the system, as well as its serviceability at all times. In order to achieve this, a suitable maintenance programme, including the correct frequency of ground checks, needs to be developed and implemented.

During daily checks, the general condition of each unit is checked to determine the following:

- (a) all lights are lighted and illuminated evenly;
- (b) there is no evidence of apparent damages;
- (c) the change from red to white is coincident for all elements in a unit; and
- (d) the lenses are not contaminated.

Regarding the alignment of VASIS, the individual unit setting angles are checked by means of angular measurement, in accordance with the manufacturer's instructions. A visual comparison between all the units in the system set at the same angle may be used to identify a unit in which there is a misalignment between the optical system and the datum plate. The cause of any misalignment of this nature needs to be ascertained and corrected before any adjustment is made to the setting angles.

Where the ground where the VASIS are installed is less stable, or intense weather phenomena such as frost, heavy rain or drought take place, or variations in weather occur, the aerodrome operator needs to adjust the ground checks of the VASIS, as such phenomena may lead to misalignment of the VASIS. In this way, gross alignment errors may be prevented.

#### FLIGHT CHECKS

Flight checks for precision approach runways are more frequent and detailed than other runway types.

Lights are checked for failures and alignment, while the VASIS are also be checked for correct approach slope, and compatibility with the non-visual aids, if available. Moreover, the balance of light intensity, at all intensity settings, needs to be checked.

During daylight flight checks, an assessment of the markings needs also to take place.

Flight checks may be arranged to be conducted with the planned calibration flights of the no-visual aids. The opportunity is also be taken to identify any confusing or misleading lights in the aerodrome surroundings.

Further guidance on how to conduct a flight check and the items that need to be checked during the flight check may be found in Chapter 5 of Part 8 'Airport Operational Services' of ICAO Doc 9137 'Airport Services Manual', and in Chapter 8 of Part 4 'Visual Aids' of ICAO Doc 9157 'Aerodrome Design Manual'.

## AMC1 ADR.OPS.C.015(d) Maintenance of visual aids and electrical systems

ED Decision 2021/003/R

### REMOVAL OF MARKINGS

Whenever, for maintenance or other purposes (e.g. relocation of markings, redesign of pavements), a marking on the movement area is not needed any longer, the marking should be physically removed. In no case should a non-needed marking be painted over.

The removal of the marking may be accomplished by using various techniques, but irrespectively of the technique used, it should not cause damage to the pavement or parts of the lighting systems.

In order to eliminate the visual appearance of the removed marking(s) on the pavement, the physical removal of any old marking(s) should include a predetermined larger size and shape of the area occupied by the marking(s), that encompasses the old marking(s), and by grouping adjacent markings together into a larger rectangular removal area.

## GM1 ADR.OPS.C.015(d) Maintenance of visual aids and electrical systems

ED Decision 2021/003/R

### REMOVAL OF MARKINGS

A marking may need to be removed for various reasons (marking patterns are changed, physical areas or operating procedures are modified, or the thickness of the layers of paint becomes excessive, etc.)

It has been found that covering markings that need to be removed, with a darker colour (e.g. black or dark grey) in order to make them resemble the colour of the adjacent pavement (e.g. runway, apron, taxiway) is likely to mislead the flight crews, as well as drivers operating in this area because of the reflection of the sun or other sources of light upon the new surface. Moreover, the surface layer of paint will wear away or erode and the lower layers will become visible and this may cause confusion.

Methods used for removing unnecessary markings include but are not limited to water blasting, sand blasting, chemical removal, burning, etc.

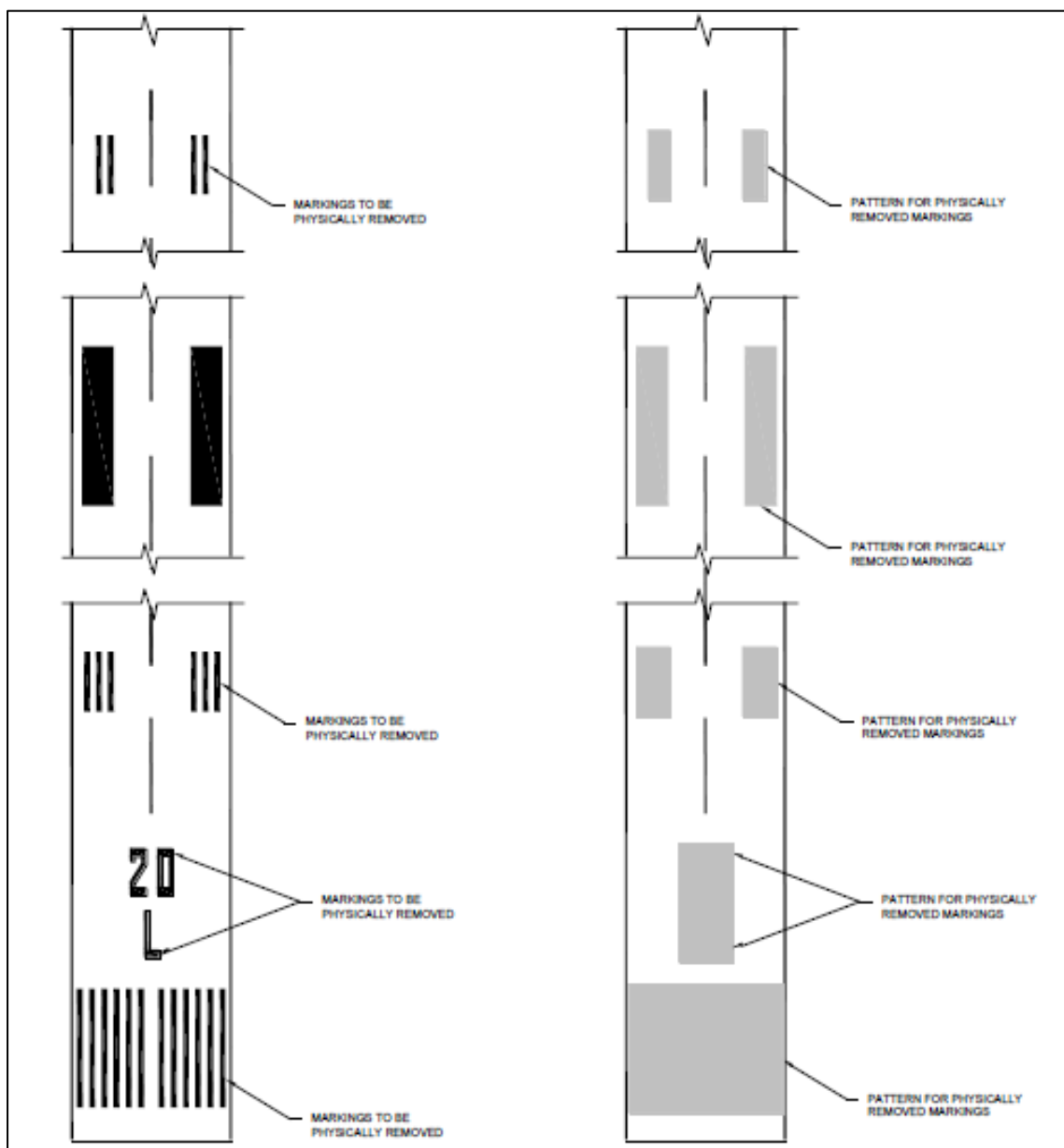
If the sand blasting method is used, arrangements are necessary to remove the sand deposited on the pavement as the work progresses, in order to prevent accumulation.

Grinding is not recommended because of the damage to the pavement surface and probable reduction of the friction characteristics.

When chemicals are used for marking removal, a large and continuous source of water is usually needed to reduce potential damage to pavement surfaces and to dilute the chemicals washed into drains or channels. Prior to the use of chemicals, consideration is necessary to the applicable environmental protection requirements.

If burning is used to remove a marking, care is necessary not to damage the pavement surface, as a result of the extended periods of exposure to the heat source.

Examples of predetermined areas that should cover the area of the old marking(s), as well as adjacent markings, appear in Figure 1.



**Figure 1**

## AMC1 ADR.OPS.C.015(d);(f) Maintenance of visual aids and electrical systems

*ED Decision 2021/003/R*

### MARKINGS AND SIGNS

#### (a) Markings

A system of preventive maintenance of visual aids should be employed to ensure marking system reliability, both day and night. All markings should be inspected thoroughly at least semiannually, depending on local weather conditions, and corrective action should be taken in case of need, such as peeling, discolourment, fading, or accumulation of deposits.

**(b) Signs**

Maintenance should ensure integrity and perfect legibility of the information provided by the signs. Checks for each sign should be both scheduled (daily, annual) and unscheduled, and should take into account the instructions of the manufacturer.

## GM1 ADR.OPS.C.015(d);(f) Maintenance of visual aids and electrical systems

*ED Decision 2021/003/R***MARKINGS AND SIGNS**

- (a) An assessment of the condition of the signs and markings performed during the night when compared with an assessment performed during the daylight, allows determining the reflectivity of the marking. Therefore, the maintenance programme takes due account of this.
- (b) Daily checks of signs need to focus on the functioning of the lamps, the legibility of inscriptions, damage to the sign panels, fading of the colours, and the removal of possible obstructions. During night inspections, the proper illumination of the signs is also checked.
- (c) Annual checks of signs include:
  - (1) the mounting of both the sign and its lighting; and
  - (2) the sign's structure.
- (d) Unscheduled checks are necessary after weather phenomena that may affect the functioning of a sign, such as snowfalls to remove snow accumulation, storms that may have damaged the signs, etc.

## SUBPART D — APRON MANAGEMENT OPERATIONS

### ADR.OPS.D.001 Apron management safety related activities

*Delegated Regulation (EU) 2020/1234*

- (a) The aerodrome operator shall ensure that means and procedures are established and implemented on the apron in order to:
- (1) regulate movement with the objective of preventing collisions between aircraft, and between aircraft and obstacles;
  - (2) regulate entry of aircraft into, and coordinate exit of aircraft from the apron with the aerodrome control tower;
  - (3) ensure safe and expeditious movement of vehicles;
  - (4) and appropriate regulation of the following activities:
    - (i) aircraft stand allocation;
    - (ii) provision of marshalling services;
    - (iii) aircraft parking procedure and departure from the stand;
    - (iv) aircraft refuelling;
    - (v) jet blast precautions and engine tests;
    - (vi) start up clearances and taxi instructions.
- (b) The aerodrome operator, in order to implement point (a) may allocate responsibilities to other organisations. If the aerodrome operator allocates such responsibilities, it shall include the allocation in the aerodrome manual.

*[applicable from 20 March 2022]*

### ADR.OPS.D.005 Apron boundaries

*Delegated Regulation (EU) 2020/1234*

- (a) The aerodrome operator, in cooperation with the air traffic service provider, shall define and provide the apron boundaries to the aeronautical information service provider for publication in the Aeronautical Information Publication (AIP).
- (b) When defining the apron boundaries, at least the following shall be taken into consideration:
- (1) aerodrome layout;
  - (2) runway and taxiway configuration and method of operation;
  - (3) traffic density;
  - (4) weather conditions;
  - (5) operational procedures.

*[applicable from 20 March 2022]*

## AMC1 ADR.OPS.D.005 Apron boundaries

*ED Decision 2020/021/R*

### PUBLICATION OF THE APRON BOUNDARIES

A graphical illustration of the apron boundaries should be shown in the Aerodrome Chart — ICAO.

*[applicable from 20 March 2022]*

## ADR.OPS.D.010 Coordination of aircraft entry to/exit from the apron

*Delegated Regulation (EU) 2020/1234*

- (a) The aerodrome operator shall ensure that the aircraft entry to and exit from the apron is coordinated with the air traffic services provider, where aircraft movement on the apron is not managed by the air traffic service provider. The coordination shall include:
  - (1) designated handover points between apron management service and air traffic service for arriving and departing aircraft;
  - (2) designated air-ground communication facilities to be used at the apron;
  - (3) holding areas for arriving aircraft when aircraft stands are not available.
- (b) The aerodrome operator shall provide to the aeronautical information service providers for publication in the Aeronautical Information Publication (AIP):
  - (1) the designated handover points referred to in point (a)(1);
  - (2) the designated air-ground communication facilities referred to in point (a)(2).

*[applicable from 20 March 2022]*

## AMC1 ADR.OPS.D.010(a)(2);(b)(2) Coordination of aircraft entry to / exit from the apron

*ED Decision 2020/021/R*

### DESIGNATED AIR-GROUND COMMUNICATION FACILITIES

- (a) Depending on the aerodrome layout, traffic density and availability of radio frequencies, air-ground communication facilities allocated to air traffic services (ATS) may also be used at the apron.
- (b) The following information should be provided for publication in the aeronautical information publication (AIP) in regard to air-ground communication facilities used at the apron:
  - (1) service designation;
  - (2) call sign;
  - (3) channel(s)/frequency(ies);
  - (4) hours of operation; and
  - (5) remarks.

*[applicable from 20 March 2022]*



## ADR.OPS.D.015 Management of aircraft movements on the apron

Delegated Regulation (EU) 2020/1234

The aerodrome operator shall ensure that:

- (a) aircraft are provided with instructions on the route to be followed on the apron;
- (b) adequate visual aids are provided in order to ensure that flight crews are able to identify the assigned route;
- (c) the intended route is free of any obstacle that may risk collision with the moving aircraft.

*[applicable from 20 March 2022]*

### AMC1 ADR.OPS.D.015(a) Management of aircraft movements on the apron

ED Decision 2020/021/R

#### AIRCRAFT GUIDANCE

Instructions to aircraft should be given either by:

- (a) issuing verbal instructions on a predetermined air–ground communication facility; or
- (b) using a ‘FOLLOW ME’ vehicle; or
- (c) appropriate marshalling hand signals; or
- (d) any combination of the above.

*[applicable from 20 March 2022]*

### GM1 ADR.OPS.D.015(b) Management of aircraft movements on the apron

ED Decision 2020/021/R

#### VISUAL AIDS

Visual aids are considered the appropriate markings, lights, signs and markers. The technical specifications are included in the Certification Specifications and Guidance Material for Aerodromes Design (CS-ADR-DSN).

*[applicable from 20 March 2022]*

### AMC1 ADR.OPS.D.015(c) Management of aircraft movement on the apron

ED Decision 2020/021/R

#### PROTECTION OF ROUTES TO BE FOLLOWED BY A MOVING AIRCRAFT (TAXI ROUTES)

The protection of the taxi route of a moving aircraft should be provided by:

- (a) segregating taxi routes from vehicular traffic and pedestrian movement;
- (b) designating dedicated areas for the parking of vehicles and equipment; and
- (c) minimising the crossing of apron taxiways, and when this is not possible because of the apron layout, by allowing crossing only at designated and clearly marked locations.

[applicable from 20 March 2022]

## ADR.OPS. D.025 Aircraft stand allocation

Delegated Regulation (EU) 2020/1234

- (a) The aerodrome operator shall establish and ensure the implementation of procedures to ensure that the allocated aircraft stand is:
- (1) suitable for the aircraft type intended to use it;
  - (2) communicated to the organisation responsible for the provision of AMS, when established, or to the appropriate air traffic service provider;
  - (3) communicated to the persons responsible for the manoeuvring of the aircraft.
- (b) The aerodrome operator shall ensure that, at least the following parameters are taken into consideration when allocating aircraft to aircraft stands:
- (1) aircraft characteristics;
  - (2) parking aids;
  - (3) facilities serving the aircraft stand;
  - (4) vicinity of infrastructure;
  - (5) other parked aircraft in the neighbouring aircraft stands;
  - (6) aircraft stand dependencies.

[applicable from 20 March 2022]

## GM1 ADR.OPS.D.025 Aircraft stand allocation

ED Decision 2020/021/R

### RESPONSIBILITY FOR AIRCRAFT STAND ALLOCATION

The overall responsibility for aircraft stand allocation normally lies with the aerodrome operator. The aerodrome operator may also decide to delegate the aircraft stand allocation to an air operator or to an organisation responsible for the provision of groundhandling services if they have a dedicated terminal or an apron area. However, the aerodrome operator remains ultimately responsible for ensuring that safety is maintained.

[applicable from 20 March 2022]

## AMC1 ADR.OPS.D.025(a)(3) Aircraft stand allocation

ED Decision 2020/021/R

### COMMUNICATION OF THE ASSIGNED AIRCRAFT STAND TO THE PERSONNEL DIRECTLY RESPONSIBLE FOR THE MANOEUVRING OF THE AIRCRAFT

The information on the stand assigned to arriving aircraft should be communicated to the personnel responsible for the manoeuvring of arriving aircraft:

- (a) through a radio frequency; or
- (b) through data link communication; or
- (c) with a 'FOLLOW ME' vehicle; or
- (d) with marshalling hand signals; or

- (e) with a visual docking guidance system; or
- (f) any combination of the above.

*[applicable from 20 March 2022]*

## GM1 ADR.OPS.D.025(b)(1) Aircraft stand allocation

*ED Decision 2020/021/R*

### CONSIDERATION OF AIRCRAFT CHARACTERISTICS FOR AIRCRAFT STAND ALLOCATION

The following aircraft characteristics are to be considered for the allocation of a stand:

(a) Fuselage length

The fuselage length is relevant for:

- (1) the dimension of the movement area (taxiway holding bays and aprons), passenger gates and terminal areas; and
- (2) the clearance at the aircraft stand.

(b) Sill height

The sill height is relevant for:

- (1) the operational limits of the passenger boarding bridges (including the number of passenger boarding bridges needed);
- (2) the mobile steps; and
- (3) the access of vehicles for passengers with reduced mobility (PRM).

(c) Tail height

The tail height is relevant for:

- (1) de-icing/anti-icing facilities; and
- (2) protection of the aerodrome's obstacle limitation surfaces.

(d) Wingspan

The wingspan is relevant for:

- (1) the dimensions of aprons and holding bays;
- (2) the stand selection; and
- (3) the clearance at the aircraft stand.

(e) Wing tip vertical clearance

The wing tip vertical clearance is relevant for apron and holding bay clearances with height-limited objects.

(f) Cockpit view

The relevant geometric parameters to assess the cockpit view are the cockpit height, the cockpit cut-off angle, and the corresponding obscured segment. The cockpit view is relevant for maintaining a view of the stand entry guidance.

(g) Engine characteristics

The engine characteristics include engine geometry and engine airflow characteristics, which may affect aerodrome infrastructure, as well as aircraft groundhandling and the operations taking place in adjacent areas which are likely to become affected from jet blast.

- (1) The engine geometry aspects are the following:
  - (i) the number of engines;
  - (ii) the location of the engines (span and length);
  - (iii) the vertical clearance of the engines; and
  - (iv) the vertical and horizontal extension of possible jet blast.
- (2) The engine airflow characteristics are the following:
  - (i) idle and breakaway thrust; and
  - (ii) inlet suction effects at ground level.

*[applicable from 20 March 2022]*

## GM1 ADR.OPS.D.025(b)(2) Aircraft stand allocation

*ED Decision 2020/021/R*

### PARKING AIDS

The following are considered parking aids:

- (a) a visual or an advanced visual docking guidance system;
- (b) a marshaller.

*[applicable from 20 March 2022]*

## GM1 ADR.OPS.D.025(b)(3) Aircraft stand allocation

*ED Decision 2020/021/R*

### FACILITIES SERVING THE AIRCRAFT STAND

The following facilities may have an impact on the allocation of aircraft stand:

- (a) passenger boarding bridges;
- (b) fixed ground power supply units;
- (c) air-conditioning units;
- (d) location of fuel pits;
- (e) equipment parking areas.

*[applicable from 20 March 2022]*

## ADR.OPS.D.030 Marshalling of aircraft

*Delegated Regulation (EU) 2020/1234*

The aerodrome operator shall ensure that marshalling of aircraft is provided using the marshalling signals in accordance with Appendix 1 to the Annex to [Commission Implementing Regulation \(EU\) No 923/2012](#)<sup>1</sup>.

*[applicable from 20 March 2022]*

## ADR.OPS.D.035 Aircraft parking

*Delegated Regulation (EU) 2020/1234*

The aerodrome operator shall establish and ensure the implementation of procedures to ensure that:

- (a) an area designated for aircraft parking on an apron is monitored to ensure that the clearance distances are maintained during the parking manoeuvre;
- (b) guidance is provided to enable the aircraft to park safely;
- (c) automated parking guidance systems, if installed, are functioning properly;
- (d) persons responsible for aircraft taxiing are alerted to stop the aircraft when the clearance distances are not maintained;
- (e) persons, other than those required to assist the aircraft parking procedure, are prohibited to approach the aircraft when anti-collision lights are turned on and engines are running;
- (f) the aircraft stand is clear of any Foreign Object Debris (FOD) that may have an impact on safety.

*[applicable from 20 March 2022]*

## AMC1 ADR.OPS.D.035(a) Aircraft parking

*ED Decision 2020/021/R*

### MONITORING OF AIRCRAFT STAND

The monitoring of an aircraft during its arrival to the assigned stand should be conducted either by assigned personnel at the stand or through cameras in order to verify that clearance distances are maintained.

*[applicable from 20 March 2022]*

## AMC1 ADR.OPS.D.035(b) Aircraft parking

*ED Decision 2020/021/R*

### GUIDANCE OF AIRCRAFT DURING PARKING MANOEUVRES

Either of the following means should be used to guide an aircraft during parking manoeuvres:

- (a) a visual or an advanced visual docking guidance system; or
- (b) a marshaller(s).

*[applicable from 20 March 2022]*

<sup>1</sup> Commission Implementing Regulation (EU) No 923/2012 of 26 September 2012 laying down the common rules of the air and operational provisions regarding services and procedures in air navigation and amending Implementing Regulation (EU) No 1035/2011 and Regulations (EC) No 1265/2007, (EC) No 1794/2006, (EC) No 730/2006, (EC) No 1033/2006 and (EU) No 255/2010 ([OJ L 281, 13.10.2012, p. 1](#)).

## AMC2 ADR.OPS.D.035(b) Aircraft parking

*ED Decision 2020/021/R*

### OPERATION OF VISUAL AND ADVANCED VISUAL DOCKING GUIDANCE SYSTEMS

The procedure for the operation of visual and advanced visual docking guidance systems should:

- (a) require the activation of the docking guidance system only when the stand is considered safe for use by the arriving aircraft and the involved personnel in charge of parking operations are present;
- (b) require the activation of the docking guidance system before the aircraft arrives at the stand;
- (c) require to check the suitability of the docking guidance system for the type of aircraft the use of the stand is intended for; and
- (d) include emergency procedures to inform the flight crew when the parking operation has to be discontinued.

*[applicable from 20 March 2022]*

## AMC3 ADR.OPS.D.035(b) Aircraft parking

*ED Decision 2020/021/R*

### PROCEDURE FOR THE PROVISION OF MARSHALLING SERVICES

- (a) The procedure for marshalling services, established by the aerodrome operator, should require the provision of marshalling services where visual or advanced visual docking guidance systems do not exist or are unserviceable, or where guidance to aircraft parking is required to avoid a safety hazard.
- (b) The procedure should include comprehensive written instructions for marshallers, including:
  - (1) the need for the marshaller to ensure, before making the authorised hand signals, that the area within which the aircraft will be guided is clear of obstacles which the aircraft, in complying with their hand signals, might otherwise hit;
  - (2) the circumstances where one or more marshallers may be used and the circumstances when wing walkers are necessary; and
  - (3) the action to be taken in the event of an emergency or incident involving an aircraft and/or a vehicle during marshalling.

*[applicable from 20 March 2022]*

## AMC1 ADR.OPS.D.035(c) Aircraft parking

*ED Decision 2020/021/R*

### INSPECTION OF VISUAL/ADVANCED VISUAL DOCKING GUIDANCE SYSTEMS

Where a visual/advanced visual docking guidance system is provided, the aerodrome operator should ensure that the stopping guidance element is calibrated and is clearly and unambiguously indicated to all selected aircraft. The visual/advanced visual docking guidance system should be regularly checked for accuracy. Such systems should be subjected to daily serviceability checks whose results should be recorded.

*[applicable from 20 March 2022]*

## ADR.OPS.D.040 Aircraft departure from the stand

Delegated Regulation (EU) 2020/1234

The aerodrome operator shall establish and ensure the implementation of procedures to ensure that during the departure of an aircraft from the aircraft stand:

- (a) ground servicing equipment, excluding push-back trucks if required for the movement of aircraft, and vehicles have been removed from the aircraft stand or parked in designated areas;
- (b) if the aircraft stand is served by passenger boarding bridges, they have been retracted;
- (c) the designated exit route from the aircraft stand is free of foreign object debris (FOD);
- (d) vehicle movements on the stand and traffic on the adjacent road(s) have ceased, except for push-back trucks if required for the movement of aircraft;
- (e) persons, other than those required to assist the aircraft departure from the aircraft stand, are prohibited to approach the aircraft when anti-collision lights are turned on and engines are running.

[applicable from 20 March 2022]

## GM1 ADR.OPS.D.040 Aircraft departure from the stand

ED Decision 2020/021/R

### DESIGNATED EXIT ROUTE

Designated exit route is the path intended to be followed by the aircraft to leave the stand.

[applicable from 20 March 2022]

## GM1 ADR.OPS.D.040(e) Aircraft departure from the stand

ED Decision 2020/021/R

### PERSONNEL THAT ASSIST AIRCRAFT TO DEPART FROM THE STAND

Personnel that assist aircraft to depart from the stand are, for example: tow-truck operators and push-back coordinators; wing walkers; personnel that remove wheel chocks, fixed and mobile ground power units and air-conditioning units.

[applicable from 20 March 2022]

## ADR.OPS.D.045 Dissemination of information to organisations operating at the apron

Delegated Regulation (EU) 2020/1234

- (a) The aerodrome operator shall disseminate information regarding limitations to operations on the apron in a timely manner to relevant organisations operating on the apron.
- (b) The information to be provided shall include the following, as applicable:
  - (1) the type of the limitation;
  - (2) the duration of the limitation, if known;
  - (3) mitigation measures to be applied;
  - (4) the operational impact of the limitation;

- (5) availability of aircraft stands;
- (6) restrictions on aircraft stands;
- (7) availability of fixed installations at aircraft stands;
- (8) special parking procedures;
- (9) temporary changes of driving routes;
- (10) work in progress;
- (11) any other information that has operational significance to the apron users.

*[applicable from 20 March 2022]*

## GM1 ADR.OPS.D.045 Dissemination of information to organisations operating at the apron

*ED Decision 2020/021/R*

### INFORMATION SHARING

Foreknowledge of the limitations to the operations at the apron will help maintain safety. The requirement to establish a process for disseminating operational information does not necessarily mean that the aerodrome operator has to develop a technical system specific to a particular aerodrome. The methods and the means selected depend on the complexity of the aerodrome, the number of organisations or apron users that have to be informed, existing systems, etc.

*[applicable from 20 March 2022]*

## ADR.OPS.D.050 Alerting of emergency services

*Delegated Regulation (EU) 2020/1234*

- (a) The aerodrome operator shall:
  - (1) establish and implement in the aerodrome emergency plan a procedure for alerting emergency services for accidents and incidents at the apron;
  - (2) provide the appropriate means and facilities for alerting the relevant emergency services.
- (b) The procedure established by the aerodrome operator shall include at least the following:
  - (1) the contact details and the means that shall be used for alerting the emergency services;
  - (2) the information that has to be given to emergency services in order to handle the incident efficiently, such as:
    - (i) location of the accident or incident;
    - (ii) nature of the accident or incident;
    - (iii) damages;
    - (iv) injuries to persons;
    - (v) dangerous goods.

*[applicable from 20 March 2022]*



## AMC1 ADR.OPS.D.050(a)(2) Alerting of emergency services

ED Decision 2020/021/R

### MEANS TO ALERT THE EMERGENCY SERVICES

The following means should be available to alert the emergency services:

- (1) radios; or
- (2) telephones; or
- (3) emergency buttons; or
- (4) any combination of the above.

[applicable from 20 March 2022]

## GM1 ADR.OPS.D.050(a)(2) Alerting of emergency services

ED Decision 2020/021/R

### SELECTION OF MEANS TO ALERT THE EMERGENCY SERVICES

The means that could be used to alert the emergency services depend on the size and complexity of the aerodrome. The requirements that apply locally would be assessed and the most appropriate means would be selected.

[applicable from 20 March 2022]

## ADR.OPS.D.055 Jet blast precautions

Delegated Regulation (EU) 2020/1234

- (a) The aerodrome operator shall make apron users aware of the hazards arising from jet blast and propeller slipstream.
- (b) The aerodrome operator shall require the apron users to secure vehicles and equipment properly and designate parking areas where the effect of jet blast or propeller slipstream is minimised.
- (c) When designing or making changes to apron layouts, the aerodrome operator shall take into consideration the effect of jet blast or propeller slipstream.
- (d) The aerodrome operator shall identify jet blast-sensitive places and shall either publish a request for minimum thrust to pilots, or take appropriate mitigating measures to minimize the jet blast effect.

[applicable from 20 March 2022]

## AMC1 ADR.OPS.D.055(a) Jet blast precautions

ED Decision 2020/021/R

### INFORMATION ON HAZARDS

Information on the hazards caused by jet blast and propeller slipstream should be provided to the apron users through:

- (a) safety training; or
- (b) safety promotion; or
- (c) a combination of the above.

[applicable from 20 March 2022]

## AMC1 ADR.OPS.D.055(d) Jet blast precautions

ED Decision 2020/021/R

### PUBLICATION OF REQUEST FOR MINIMUM THRUST

The request to pilots for minimum thrust at specific locations at the apron should be published in the aeronautical information publication (AIP). If necessary, information signs may be installed at these locations.

[applicable from 20 March 2022]

## ADR.OPS.D.060 Aircraft refuelling

Delegated Regulation (EU) 2020/1234

- (a) The aerodrome operator shall establish a procedure for aircraft refuelling.
- (b) The procedure shall require the following:
  - (1) the prohibition of open flames and the use of electrical or similar tools likely to produce sparks or arcs within the refuelling zone;
  - (2) the prohibition to start ground power units during refuelling;
  - (3) the existence of an unobstructed path from the aircraft to allow the quick removal of fuel bowsers and persons in case of emergency;
  - (4) the correct bonding of aircraft and fuel supply sources and the correct application of earthing procedures;
  - (5) the immediate notification of the fuelling supervisor in case of fuel spillage and detailed instructions on how to handle fuel spillages;
  - (6) the positioning of ground support equipment in such a way that emergency exits are free of any obstruction to allow the expeditious evacuation of the passengers, if passengers are embarking or disembarking or remain in the aircraft during refuelling;
  - (7) the ready availability of fire extinguishers of a suitable type for at least initial intervention in the event of a fuel fire;
  - (8) the discontinuation of refuelling operations if electrical thunderstorms are at or in the vicinity of the aerodrome.

[applicable from 20 March 2022]

## ADR.OPS.D.065 Engine test

Delegated Regulation (EU) 2020/1234

- (a) The aerodrome operator shall establish and implement an engine test procedure.
- (b) The procedure shall include the following:
  - (1) the person that has the authority to approve engine tests;
  - (2) the areas where engine tests are conducted;
  - (3) the safety measures that need to be taken.

[applicable from 20 March 2022]

## GM1 ADR.OPS.D.065 Engine test

*ED Decision 2020/021/R*

### GENERAL

- (a) Where possible, engine tests are performed at designated remote areas.
- (b) Engine run-ups at or above idle power are not permitted in cul-de-sacs, or in areas where the jet efflux would affect stands, equipment areas or work areas.
- (c) Engine tests approved at stands in regular use at the apron should be limited to check starts and idle power only.
- (d) Where engine tests are permitted to be performed at the apron, a remote area should be selected where the jet blast will not affect other apron areas and busy taxiways.
- (e) Where necessary, engine tests are safeguarded by ground personnel that arrange for any rear of stand roads and, if needed, sections of the taxiway to be closed.
- (f) The area behind and adjacent to the cone(s) of the blast will be clear of equipment and the ground must be firm and without loose tarmac, stones or other material.

*[applicable from 20 March 2022]*

## ADR.OPS.D.070 High-visibility clothing

*Delegated Regulation (EU) 2020/1234*

The aerodrome operator shall require that all personnel working outside, on foot, on the movement area shall wear high-visibility clothing.

*[applicable from 20 March 2022]*

## ADR.OPS.D.075 Start-up clearances and taxi instructions

*Delegated Regulation (EU) 2020/1234*

- (a) The aerodrome operator shall ensure that start-up clearances, push-back clearances, if required, and taxi instructions are coordinated with the air traffic service provider, when the aircraft movement on the apron is not managed by the air traffic service provider.
- (b) In this case, the aerodrome operator in cooperation with the air traffic service provider shall establish and implement a procedure, which shall include the following:
  - (1) definition of the authority to issue start-up clearances;
  - (2) means to inform each other for start-up clearances issued;
  - (3) means to inform each other of push-back clearances and taxi instructions given.

*[applicable from 20 March 2022]*

## ADR.OPS.D.080 Training and proficiency check programmes of marshallers and “FOLLOW-ME” drivers

*Delegated Regulation (EU) 2020/1234*

- (a) The aerodrome operator shall establish and ensure the implementation of a training programme for persons providing:
  - (1) marshalling service;

- (2) “FOLLOW-ME” guidance.
- (b) The training programme shall be implemented in accordance with point ADR.OR.D.017 of Annex III.
- (c) The training shall be designed to impart fundamental knowledge and practical skills related to the execution of their duties.
- (d) The aerodrome operator shall ensure the implementation of a proficiency check programme for personnel referred to in point (a) in order to ensure:
- (1) their continued competence;
  - (2) that they are aware of the rules and procedures relevant to their functions and tasks. The aerodrome operator shall ensure that persons referred to in point (a) undergo proficiency checks at intervals not exceeding 12 months since the completion of their initial training.

*[applicable from 20 March 2022]*

## AMC1 ADR.OPS.D.080(a)(1);(2) Training and proficiency check programme of marshallers and ‘FOLLOW-ME’ drivers

*ED Decision 2020/021/R*

### TRAINING FOR MARSHALLERS

- (a) As part of the training programme, the initial training for marshallers should cover, at least, the following aspects:
- (1) the role and responsibilities of the marshaller;
  - (2) the visual signals included in Appendix 1 ‘Signals’ to the Annex to [Commission Regulation \(EU\) No 923/2012](#) of 26 September 2012;
  - (3) aircraft characteristics, both physical and operational, which relate to the manoeuvring of aircraft within the confines of the apron;
  - (4) safety procedures around the aircraft and particularly around the engines;
  - (5) emergency procedures in the event of an accident or an incident at the apron;
  - (6) low-visibility procedures;
  - (7) driving at the apron;
  - (8) emergency stop procedures for visual or advanced visual docking guidance systems, if applicable; and
  - (9) aircraft stand configuration and layout.
- (b) Marshallers should be briefed or, if required, trained in new procedures or in changes to existing procedures.

*[applicable from 20 March 2022]*

## AMC1 ADR.OPS.D.080(a)(2);(b)(2)(i) Training and proficiency check programme of marshallers and 'FOLLOW-ME' drivers

*ED Decision 2020/021/R*

### TRAINING FOR 'FOLLOW-ME' VEHICLE DRIVERS

- (a) As part of the training programme, the initial training for 'FOLLOW ME' drivers should cover, at least, the following aspects:
- (1) the role and responsibilities of the 'FOLLOW-ME' driver;
  - (2) the content of [AMC2 ADR.OPS.B.025](#) 'Operation of vehicles';
  - (3) 'FOLLOW-ME' specific communication procedures, including radiotelephony procedures;
  - (4) the visual signals included in Appendix 1 'Signals' to the Annex to [Commission Regulation \(EU\) No 923/2012](#) of 26 September 2012;
  - (5) aircraft taxiing speed and appropriate aircraft–vehicle spacing;
  - (6) specific procedures for guiding aircraft and/or vehicles;
  - (7) aircraft characteristics, both physical and operational;
  - (8) 'FOLLOW-ME' specific procedures for low-visibility operations;
  - (9) emergency procedures in the event of an accident or an incident; and
  - (10) the operation of 'FOLLOW-ME' vehicles and their equipment.
- (b) 'FOLLOW-ME' vehicle drivers should be briefed or, if required, trained in new procedures or in changes to existing procedures.

*[applicable from 20 March 2022]*

## ADR.OPS.D.085 Training and proficiency check programme of personnel providing taxi instructions to aircraft through radiotelephony

*Delegated Regulation (EU) 2020/1234*

- (a) The aerodrome operator shall ensure that:
- (1) persons providing taxi instructions to aircraft on the apron through radiotelephony, using the assigned aeronautical radio frequencies, are appropriately trained and qualified;
  - (2) the training programme is implemented in accordance with point [ADR.OR.D.017](#) of Annex III, with the following exceptions:
    - (i) the initial training shall be followed by a unit training which comprises the following phases:
      - (A) transitional training phase, designed primarily to impart knowledge and understanding of site-specific operational procedures and task-specific aspects;
      - (B) on-the-job training phase, which is the final phase of unit training during which previously acquired job-related routines and skills are integrated in practice under the supervision of a qualified training instructor in a live traffic situation;

- (ii) recurrent training shall be conducted at intervals not exceeding 12 calendar months and contains a review of the initial training content
  - (iii) refresher training shall be conducted when a person is absent from duties for a period of more than 12 months and shall include the entire initial training content.
- (b) Persons referred to in point (a)(1) shall demonstrate language proficiency, at least at an operational level both in the use of phraseologies and in plain language, in accordance with point (c), in the languages used for air-ground communication at the aerodrome.
- (c) The applicant shall demonstrate the ability to:
  - (1) communicate effectively in voice-only and in face-to-face situations;
  - (2) communicate on common and work-related topics with accuracy and clarity;
  - (3) use appropriate communicative strategies to exchange messages and to recognise and resolve misunderstandings in a general or work-related context;
  - (4) handle successfully the linguistic challenges presented by a complication or unexpected turn of events which occurs within the context of a routine work situation or communicative task with which they are otherwise familiar;
  - (5) use a dialect or accent which is intelligible to the aeronautical community.
- (d) Language proficiency shall be demonstrated by a certificate issued by the organisation that conducted the assessment, attesting the language or languages, the level or levels of proficiency, and the date of the assessment.
- (e) Except for persons who have demonstrated language proficiency at an expert level, the language proficiency shall be re-assessed every:
  - (1) four years from the date of the assessment, if the level demonstrated is operational level;
  - (2) six years from the date of the assessment, if the level demonstrated is extended level.
- (f) The demonstration of language proficiency shall be done through a method of assessment, which shall contain:
  - (1) the process by which an assessment is done;
  - (2) the qualifications of the assessors conducting assessments of language proficiency;
  - (3) the appeal procedure.
- (g) The aerodrome operator shall make available language training to maintain the required level of language proficiency of its personnel.
- (h) The aerodrome operator shall ensure the implementation of a proficiency check programme for personnel referred to in point (a)(1) in order to ensure:
  - (1) their continued competence;
  - (2) that they are aware of the rules and procedures relevant to their functions and tasks. The aerodrome operator shall ensure that persons referred to in point (a) undergo proficiency checks at intervals not exceeding 12 months since the completion of their initial training.

*[applicable from 20 March 2022]*

## AMC1 ADR.OPS.D.085(a)(2)(i) Training and proficiency check programme of personnel providing taxi instructions to aircraft through radiotelephony

ED Decision 2020/021/R

### INITIAL TRAINING

The initial training should include at least the following modules:

#### MODULE 1. General overview of apron management

- (a) Air traffic procedures relevant to aerodrome operations;
- (b) Air traffic flow management (ATFM) basic knowledge;
- (c) Introduction to apron management services (AMS);
- (d) Description of tasks and responsibilities;
- (e) Aircraft characteristics, aircraft types, and air operator identification;
- (f) Basics of meteorology;
- (g) Operational agreements and procedures for the cooperation between apron management services (AMS) providers and other entities;
- (h) Traffic priorities at the apron: aircraft, equipment, vehicles;
- (i) Basic knowledge of air navigation services (ANS);
- (j) Aeronautical information publication (AIP).

#### MODULE 2. Aeronautical law

- (a) Introduction to aeronautical law;
- (b) International aviation bodies;
- (c) National aviation bodies;
- (d) Overview of the relevant national and international legislation.

#### MODULE 3. Apron management services (AMS) equipment

- (a) IT systems;
- (b) Communication systems;
- (c) Surveillance systems, such as closed-circuit television (CCTV), surface movement radar (SMR), etc.;
- (d) Airfield lighting systems relevant to the provision of AMS;
- (e) Visual/advanced visual docking guidance systems;
- (f) Backup systems.

#### MODULE 4. Communication procedures and phraseology

- (a) Radiotelephony communication phraseology;
- (b) Communication procedures during emergencies;
- (c) Radio communication with aircraft;
- (d) Other communications on the apron.

---

#### MODULE 5. Procedures for arriving aircraft

- (a) Coordination with ATS and handover of aircraft between ATS and AMS;
- (b) Aircraft taxiing;
- (c) Holding areas;
- (d) Recording of on-block time;
- (e) Aerodrome collaborative decision making (A-CDM) procedures.

#### MODULE 6. Procedures for departing aircraft

- (a) Start-up clearances;
- (b) Push-back, towing;
- (c) Aircraft taxiing;
- (d) Coordination with ATS and handover of aircraft between ATS and AMS;
- (e) Recording of off-block time;
- (f) Aerodrome collaborative decision making (A-CDM) procedures.

#### MODULE 7. Procedures for emergencies and incidents

- (a) Awareness of the aerodrome emergency plan;
- (b) Alerting of emergency services;
- (c) Aircraft emergencies;
- (d) Aircraft incidents at the apron;
- (e) Other emergencies and incidents at the apron.

#### MODULE 8. Safety awareness

- (a) Human factors;
- (b) Basics of safety management;
- (c) Internal and/or aerodrome safety management system (SMS).

#### MODULE 9. Stand allocation

- (a) Factors that affect stand allocation to aircraft;
- (b) Stand allocation procedures.

#### MODULE 10. Ground-servicing of aircraft

- (a) Turn-around process overview;
- (b) Special ground-servicing procedures.

#### MODULE 11. Coordination between apron management services (AMS) and air traffic services (ATS) providers

- (a) Written agreement between AMS and ATS providers;
- (b) Operational procedures for the cooperation between AMS and ATS;
- (c) Communication with ATS;
- (d) Areas of responsibility of the AMS and the ATS providers.



**MODULE 12. All-weather operations**

- (a) Visibility conditions;
- (b) Adverse weather procedures;
- (c) Winter operations.

*[applicable from 20 March 2022]*

**AMC1 ADR.OPS.D.085(a)(2)(ii) Training and proficiency check programme of personnel providing taxi instructions to aircraft through radiotelephony**

*ED Decision 2020/021/R*

**UNIT TRAINING**

The unit training should include the following subjects:

- (a) Local operational agreements;
- (b) Aerodrome layout;
- (c) Local aerodrome procedures, included in the aerodrome manual, as regards:
  - (1) low visibility,
  - (2) adverse weather,
  - (3) aerodrome emergency plan,
  - (4) coordination with the ATS unit,
  - (5) coordination with the aerodrome operator,
  - (6) handover points,
  - (7) contingency procedures in case of systems' failure.

When the training programme includes on-the-job training, it should include the provision of taxi instructions to aircraft through radiotelephony under the supervision of an appropriately qualified and experienced instructor.

*[applicable from 20 March 2022]*

**AMC1 ADR.OPS.D.085(f) Training and proficiency check programme of personnel providing taxi instructions to aircraft through radiotelephony**

*ED Decision 2020/021/R*

**GENERAL**

- (a) The language proficiency assessment should be designed to reflect the tasks undertaken, but with special focus on the knowledge of the language rather than on the knowledge of the operational procedures.
- (b) The assessment should determine the applicant's ability to:
  - (1) communicate effectively by using standard radiotelephony phraseology;

- (2) deliver and understand messages in plain language in both usual and unusual situations that require departure from standard radiotelephony phraseology;
- (3) demonstrate the linguistic ability in dealing with an unexpected turn of events, and in correcting apparent misunderstandings.

*[applicable from 20 March 2022]*

## **AMC2 ADR.OPS.D.085(f) Training and proficiency check programme of personnel providing taxi instructions to aircraft through radiotelephony**

*ED Decision 2020/021/R*

### **ASSESSMENT**

- (a) The assessment should comprise the following three elements:
  - (1) listening: assessment of comprehension;
  - (2) speaking: assessment of pronunciation, fluency, structure and vocabulary; and
  - (3) interaction.
- (b) The switch between phraseology and plain language should be assessed in relation to listening and speaking proficiency.
- (c) When the assessment is not conducted in a face-to-face situation, appropriate technologies should be used for the assessment of the person's ability to listen and speak, and to enable interactions.
- (d) The assessment should also be conducted during training activities or during proficiency checks, with prior notification given to the person concerned.

*[applicable from 20 March 2022]*

- (e) The assessment should be conducted using the rating scale in [AMC1 ADR.OPS.B.029\(b\)](#).

*[applicable from 20 March 2022 — ED Decision 2021/003/R]*

## **AMC3 ADR.OPS.D.085(f) Training and proficiency check programme of personnel providing taxi instructions to aircraft through radiotelephony**

*ED Decision 2020/021/R*

### **LANGUAGE PROFICIENCY ASSESSORS**

- (a) The persons responsible for the language proficiency assessment should be appropriately trained and qualified.
- (b) The language proficiency assessors should undergo regular refresher training in the assessment of language skills.
- (c) The language proficiency assessors should not conduct language proficiency assessments of persons to whom they have provided language training, or whenever, for any other reason, their objectivity may be affected.

*[applicable from 20 March 2022]*

## AMC4 ADR.OPS.D.085(f) Training and proficiency check programme of personnel providing taxi instructions to aircraft through radiotelephony

ED Decision 2020/021/R

### CRITERIA FOR THE ACCEPTABILITY OF LANGUAGE ASSESSMENT ORGANISATIONS

- (a) If the language assessment organisation provides also language training, there should be a clear and documented separation between the two activities.
- (b) The language assessment organisation should employ a sufficient number of qualified interlocutors and language proficiency assessors to administer the tests.
- (c) The assessment documentation should include at least the following:
  - (1) assessment objectives;
  - (2) assessment layout, timescale, technologies used, assessment samples, voice samples;
  - (3) assessment criteria and standards (at least for the 'operational', 'extended' and 'expert' level);
  - (4) documentation that demonstrates the assessment validity, relevance and reliability for the 'operational', 'extended' and 'expert' level;
  - (5) procedures to ensure that language assessments are standardised within the organisation and across apron management services (AMS) organisations, aerodrome organisations, and the air traffic control (ATC) community;
  - (6) assessment procedures and responsibilities:
    - (i) preparation of individual assessments;
    - (ii) administration: location(s), identity check and invigilation, assessment discipline, confidentiality/security;
    - (iii) reporting and documentation provided to the aerodrome operator and to the organisation responsible for the provision of AMS or to the applicant, including sample certificates; and
    - (iv) retention of documents and records.
- (d) The assessment documentation and records should be kept for a period of time determined by the Competent Authority and made available to the Competent Authority upon request.

[applicable from 20 March 2022]

## GM1 ADR.OPS.D.085(f) Training and proficiency check programme of personnel providing taxi instructions to aircraft through radiotelephony

ED Decision 2020/021/R

### LANGUAGE PROFICIENCY ASSESSMENT

The aim of the assessment is to determine the ability of a person to speak and understand the language(s) used for radiotelephony communications.

- (a) The assessment includes:

- 
- (1) voice-only or face-to-face situations;
  - (2) common, concrete, and work-related topics.
- (b) The assessment determines the applicant's ability to speak and listen. A mere assessment of the applicant's knowledge of grammar as well as their reading and writing skills is not appropriate.
- (c) The assessment determines the language skills of the applicant in the following areas:
- (1) pronunciation:
    - (i) the extent to which the pronunciation, stress, rhythm and intonation are influenced by the applicant's native language or national variations;
    - (ii) how much they interfere with ease of understanding;
  - (2) structure:
    - (i) the ability of the applicant to use both basic and complex grammatical structures;
    - (ii) the extent to which the errors the applicant makes interfere with the intended meaning;
  - (3) vocabulary:
    - (i) the range and accuracy of the vocabulary used;
    - (ii) the ability of the applicant to paraphrase successfully when they lack the vocabulary;
  - (4) fluency:
    - (i) tempo;
    - (ii) hesitancy;
    - (iii) rehearsed versus spontaneous speech;
    - (iv) use of discourse markers and connectors;
  - (5) comprehension:
    - (i) of common, concrete, and work-related topics;
    - (ii) when confronted with a linguistic or situational complication or an unexpected turn of events;
  - (6) interactions:
    - (i) quality of response (immediate, appropriate, and informative);
    - (ii) the ability to initiate and maintain short conversations:
      - (A) on common, concrete, and work-related topics;
      - (B) when dealing with an unexpected turn of events;
    - (iii) the ability to deal with apparent misunderstandings by checking, confirming, or clarifying.

The accent or the variety of accents used in the test material needs to be sufficiently intelligible for an international community of users.

*[applicable from 20 March 2022]*

## GM2 ADR.OPS.D.085(f) Training and proficiency check programme of personnel providing taxi instructions to aircraft through radiotelephony

*ED Decision 2020/021/R*

### LANGUAGE PROFICIENCY ASSESSORS

- (a) The preferred approach for a language proficiency assessment is to form an assessment team that consists of an operational expert and a language expert.
- (b) The language proficiency assessors need to be trained in the requirements specific to the language proficiency assessment, as well as to assessment and interlocution techniques.

*[applicable from 20 March 2022]*

## GM3 ADR.OPS.D.085(f) Training and proficiency check programme of personnel providing taxi instructions to aircraft through radiotelephony

*ED Decision 2020/021/R*

Further guidance on the assessment of language proficiency may be found in ICAO Doc 9835 'Manual on the Implementation of ICAO Language Proficiency Requirements'.

*[applicable from 20 March 2022]*

## AMC1 ADR.OPS.D.085(g) Training and proficiency check programme of personnel providing taxi instructions to aircraft through radiotelephony

*ED Decision 2020/021/R*

### LANGUAGE TRAINING

- (a) Language training should contain communication in a job-related context, and in particular to the handling of abnormal and emergency situations and the conduct of non-routine coordination with colleagues, aircrews and technical staff.
- (b) Emphasis should be placed on listening comprehension, speaking interaction and vocabulary building.

*[applicable from 20 March 2022]*

## GM1 ADR.OPS.D.085(g) Training and proficiency check programme of personnel providing taxi instructions to aircraft through radiotelephony

*ED Decision 2020/021/R*

### LANGUAGE TRAINING

A purely routine use of the language through phraseology, standard procedures and limited social contact only maintains a limited core usage of the language which might be inadequate for managing unexpected and abnormal situations.

Language proficiency erosion (language attrition) occurs rapidly over time: the lower the initial level, the faster the rate of erosion — unless systematic strategies and a high degree of motivation counteract this trend.

It is documented that one's language and communicative proficiency, even in one's native language, deteriorates sharply under stress; therefore, regular participation in language training is recommended.

*[applicable from 20 March 2022]*

# CS-ADR-DSN — ISSUE 5

## CERTIFICATION SPECIFICATIONS AND GUIDANCE MATERIAL FOR AERODROME DESIGN

### PREAMBLE

**CS-ADR-DSN Issue 5**
**Effective: See Decision 2021/004/R**

The following is a list of paragraphs affected by this amendment:

CS ADR-DSN.A.001	Applicability	Editorial change
GM1 ADR-DSN.A.001	Applicability	Editorial change
CS ADR-DSN.A.002	Definitions	Amended (NPA 2018-14)
GM1 ADR-DSN.B.030	Runway threshold	Editorial change
CS ADR-DSN.B.165	Objects on runway strips	Amended (NPA 2018-14)
GM1 ADR-DSN.D.295	Rapid exit taxiways	Editorial change
GM1 ADR-DSN.H.405	Applicability	Editorial change
CS ADR-DSN.M.626	Simple approach lighting systems	Editorial change
CS ADR-DSN.M.630	Precision approach Category I lighting system	Amended (NPA 2018-14)
CS ADR-DSN.M.635	Precision approach Category II and III lighting system	Amended (NPA 2018-14)
CS ADR-DSN.M.690	Runway centre line lights	Amended (NPA 2018-14)
CS ADR-DSN.M.705	Stopway lights	Amended (NPA 2018-14)
CS ADR-DSN.Q.850		Amended (NPA 2018-14)
GM1 ADR-DSN.Q.850		Amended (NPA 2018-14)
CS ADR-DSN.R.855	Closed runways and taxiways, or parts thereof	Amended (NPA 2018-14)
GM1 ADR-DSN.R.855	Closed runways and taxiways, or parts thereof	Amended (NPA 2018-14)
CS ADR-DSN.S.880	Electrical power supply systems	Amended (NPA 2018-14)
CS ADR-DSN.S.890	Monitoring	Amended (NPA 2018-14)
CS ADR-DSN.S.895		Amended (NPA 2018-14)
GM1 ADR-DSN.S.895		Amended (NPA 2018-14)
GM1 ADR-DSN.T.915	Siting of equipment and installations on operational areas	Editorial change

**CS-ADR-DSN Issue 4**
**Effective: See Decision 2017/021/R**

The following is a list of paragraphs affected by this amendment:

List of abbreviations		Added
CS ADR-DSN.A.002	Definitions	Amended (NPA 2017-04)
CS ADR-DSN.A.005	Aerodrome reference code (ARC)	Amended (NPA 2017-04)
CS ADR-DSN.B.045	Width of runways	Amended (NPA 2017-04)
CS ADR-DSN.B.095	Runway turn pads	Amended (NPA 2017-04)
CS ADR-DSN.B.125	Runway shoulders	Amended (NPA 2017-04)
CS ADR-DSN.B.135	Width of runway shoulders	Amended (NPA 2017-04)

CS ADR-DSN.B.140	Strength of runway shoulders	Amended (NPA 2017-04)
CS ADR-DSN.B.145	Surface of runway shoulders	Amended (NPA 2017-04)
CS ADR-DSN.B.150	Runway strip to be provided	Amended (NPA 2017-04)
CS ADR-DSN.B.160	Width of runway strip	Amended (NPA 2017-04)
CS ADR-DSN.B.175	Grading of runway strip	Amended (NPA 2017-04)
CS ADR-DSN.D.240	Taxiways general	Amended (NPA 2017-04)
CS ADR-DSN.D.245	Width of taxiways	Amended (NPA 2017-04)
CS ADR-DSN.D.260	Taxiway minimum separation distance	Amended (NPA 2017-04)
CS ADR-DSN.D.305	Taxiway shoulders	Amended (NPA 2017-04)
CS ADR-DSN.D.325	Grading of taxiway strips	Amended (NPA 2017-04)
CS ADR-DSN.J.480	Precision approach runways	Amended (NPA 2017-04)
CS ADR-DSN.L.565	Runway turn pad marking	Amended (NPA 2017-04)
CS ADR-DSN.L.605	Mandatory instruction marking	Amended (NPA 2017-04)
CS ADR-DSN.L.610	Information marking	Amended (NPA 2017-04)
CS ADR-DSN.M.630	Precision approach Category I lighting system	Amended (NPA 2017-04)
CS ADR-DSN.M.635	Precision approach Category II and III lighting system	Amended (NPA 2017-04)
CS ADR-DSN.M.645	Precision approach path indicator and Abbreviated precision approach path indicator (PAPI and APAPI)	Amended (NPA 2017-04)
CS ADR-DSN.M.655	Obstacle protection surface for PAPI and APAPI	Amended (NPA 2017-04)
CS ADR-DSN.M.665	Runway lead-in lighting systems	Amended (NPA 2017-04)
CS ADR-DSN.M.670	Runway threshold identification lights	Amended (NPA 2017-04)
CS ADR-DSN.M.675	Runway edge lights	Amended (NPA 2017-04)
CS ADR-DSN.M.680	Runway threshold and wing bar lights	Amended (NPA 2017-04)
CS ADR-DSN.M.685	Runway end lights	Amended (NPA 2017-04)
CS ADR-DSN.M.690	Runway centre line lights	Amended (NPA 2017-04)
CS ADR-DSN.M.695	Runway touchdown zone lights	Amended (NPA 2017-04)
CS ADR-DSN.M.696	Simple touchdown zone lights	Amended (NPA 2017-04)
CS ADR-DSN.M.700	Rapid exit taxiway indicator lights (RETILs)	Amended (NPA 2017-04)
CS ADR-DSN.M.705	Stopway lights	Amended (NPA 2017-04)
CS ADR-DSN.M.706	Runway status lights (RWSL)	Created (NPA 2017-04)
CS ADR-DSN.M.710	Taxiway centre line lights	Amended (NPA 2017-04)
CS ADR-DSN.M.720	Taxiway edge lights	Amended (NPA 2017-04)
CS ADR-DSN.M.725	Runway turn pad lights	Amended (NPA 2017-04)
CS ADR-DSN.M.730	Stop bars	Amended (NPA 2017-04)
CS ADR-DSN.M.735	Intermediate holding position lights	Amended (NPA 2017-04)
CS ADR-DSN.M.740	De-icing/anti-icing facility exit lights	Amended (NPA 2017-04)
CS ADR-DSN.M.745	Runway guard lights	Amended (NPA 2017-04)
CS ADR-DSN.M.760	Advanced visual docking guidance system	Amended (NPA 2017-04)
CS ADR-DSN.M.771	No-entry bar	Amended (NPA 2017-04)
CS ADR-DSN.N.775	General	Amended (NPA 2017-04)
CS ADR-DSN.N.780	Mandatory instruction signs	Amended (NPA 2017-04)
CS ADR-DSN.N.785	Information signs	Amended (NPA 2017-04)
CS ADR-DSN.N.795	Aircraft stand identification signs	Amended (NPA 2017-04)
CS ADR-DSN.N.800	Road-holding position sign	Amended (NPA 2017-04)
CS ADR-DSN.Q.846	Lighting of fixed objects	Amended (NPA 2017-04)



CS ADR-DSN.Q.852	Marking and lighting of overhead wires, cables, supporting towers, etc.	Amended (NPA 2017-04)
CS ADR-DSN.S.880	Electrical power supply systems	Amended (NPA 2017-04)
CS ADR-DSN.T.921	Autonomous runway incursion warning system (ARIWS)	Created (NPA 2017-04)
CS ADR-DSN.U.925	General	Amended (NPA 2017-04)
CS ADR-DSN.U.930	Colours for aeronautical ground lights	Amended (NPA 2017-04)
CS ADR-DSN.U.940	Aeronautical ground light characteristics	Amended (NPA 2017-04)
GM1 ADR-DSN.A.005	Aerodrome reference code (ARC)	Amended (NPA 2017-04)
GM1 ADR-DSN.B.015	Number, siting, and orientation of runways	Amended (NPA 2017-04)
GM1 ADR-DSN.B.025	Data to be used	Amended (NPA 2017-04)
GM1 ADR-DSN.B.030	Runway threshold	Amended (NPA 2017-04)
GM1 ADR-DSN.B.045	Width of runways	Amended (NPA 2017-04)
GM1 ADR-DSN.B.060	Longitudinal slopes on runways	Amended (NPA 2017-04)
GM1 ADR-DSN.B.080	Transverse slopes on runways	Amended (NPA 2017-04)
GM1 ADR-DSN.B.095	Runway turn pads	Amended (NPA 2017-04)
GM1 ADR-DSN.B.125	Runway shoulders	Amended (NPA 2017-04)
GM1 ADR-DSN.B.140	Strength of runway shoulders	Amended (NPA 2017-04)
GM1 ADR-DSN.B.145	Surface of runway shoulders	Amended (NPA 2017-04)
GM1 ADR-DSN.B.150	Runway strip to be provided	Amended (NPA 2017-04)
GM1 ADR-DSN.B.165	Objects on runway strips	Amended (NPA 2017-04)
GM1 ADR-DSN.B.175	Grading of runway strips	Amended (NPA 2017-04)
GM1 ADR-DSN.B.185	Transverse slopes on runway strips	Amended (NPA 2017-04)
GM1 ADR-DSN.D.240	Taxiways general	Amended (NPA 2017-04)
GM1 ADR-DSN.D.245	Width of taxiways	Amended (NPA 2017-04)
GM1 ADR-DSN.D.260	Taxiway minimum separation distance	Amended (NPA 2017-04)
GM1 ADR-DSN.D.320	Objects on taxiway strips	Amended (NPA 2017-04)
GM1 ADR-DSN.D.325	Grading of taxiway strips	Amended (NPA 2017-04)
GM1 ADR-DSN.D.330	Slopes on taxiway strips	Amended (NPA 2017-04)
GM1 ADR-DSN.E.365	Clearance distances on aircraft stands	Amended (NPA 2017-04)
GM1 ADR-DSN.L.540	Aiming point marking	Amended (NPA 2017-04)
GM1 ADR-DSN.L.560	Interruption of runway markings	Amended (NPA 2017-04)
GM1 ADR-DSN.L.565	Runway turn pad marking	Amended (NPA 2017-04)
GM1 ADR-DSN.L.605	Mandatory instruction marking	Amended (NPA 2017-04)
GM1 ADR-DSN.M.625	Approach lighting systems	Amended (NPA 2017-04)
GM1 ADR-DSN.M.630	Precision approach Category I lighting system	Amended (NPA 2017-04)
GM1 ADR-DSN.M.655	Obstacle protection surface for PAPI and APAPI	Amended (NPA 2017-04)
GM1 ADR-DSN.M.670	Runway threshold identification lights	Amended (NPA 2017-04)
GM1 ADR-DSN.M.690	Runway centre line lights	Amended (NPA 2017-04)
GM1 ADR-DSN.M.700	Rapid exit taxiway indicator lights (RETILs)	Amended (NPA 2017-04)
GM1 ADR-DSN.M.706	Runway status lights (RWSLs)	Created (NPA 2017-04)
GM1 ADR-DSN.M.750	Apron floodlighting	Amended (NPA 2017-04)
GM1 ADR-DSN.P.825	Taxiway edge markers	Amended (NPA 2017-04)
GM1 ADR-DSN.T.921	Autonomous runway incursion warning system (ARIWS)	Created (NPA 2017-04)
GM1 ADR-DSN.U.930	Colours for aeronautical ground lights	Amended (NPA 2017-04)

CS-ADR-DSN Issue 3

Effective: See Decision 2016/027/R

The following is a list of paragraphs affected by this amendment:

CS ADR-DSN.A.002	Definitions	Amended (NPA 2016-04)
CS ADR-DSN.A.005	Aerodrome reference code	Amended (NPA 2016-04)
CS ADR-DSN.B.035	Length of runway and declared distances	Amended (NPA 2016-04)
CS ADR-DSN.B.055	Minimum distance between parallel instrument runways	Amended (NPA 2016-04)
CS ADR-DSN.B.060	Longitudinal slopes of runways	Amended (NPA 2016-04)
CS ADR-DSN.B.090	Surface of runways	Amended (NPA 2016-04)
CS ADR-DSN.B.110	Surface of runway turn pads	Amended (NPA 2016-04)
CS ADR-DSN.B.135	Width of runway shoulders	Amended (NPA 2016-04)
CS ADR-DSN.B.155	Length of runway strip	Amended (NPA 2016-04)
CS ADR-DSN.B.165	Objects on runway strips	Amended (NPA 2016-04)
CS ADR-DSN.B.191	Drainage characteristics of the movement area and adjacent areas	Created (NPA 2016-04)
CS ADR-DSN.B.195	Clearways	Amended (NPA 2016-04)
CS ADR-DSN.B.200	Stopways	Amended (NPA 2016-04)
CS ADR-DSN.B.205	Radio altimeter operating area	Amended (NPA 2016-04)
CS ADR-DSN.C.210	Runway end safety areas (RESA)	Amended (NPA 2016-04)
CS ADR-DSN.C.215	Dimensions of runway end safety areas	Amended (NPA 2016-04)
CS ADR-DSN.C.235	Strength of runway end safety areas	Created (NPA 2016-04)
CS ADR-DSN.D.290	Surface of taxiways	Amended (NPA 2016-04)
CS ADR-DSN.D.315	Width of taxiway strips	Amended (NPA 2016-04)
CS ADR-DSN.D.335	Holding bays, runway-holding positions, intermediate holding positions, and road-holding positions	Amended (NPA 2016-04)
CS ADR-DSN.D.340	Location of holding bays, runway-holding positions, intermediate holding positions, and road-holding positions	Amended (NPA 2016-04)
CS ADR-DSN.E.360	Slopes on aprons	Amended (NPA 2016-04)
CS ADR-DSN.E.365	Clearance distances on aircraft stands	Amended (NPA 2016-04)
CS ADR-DSN.G.400	Clearance distances on a de-icing/anti-icing pad	Amended (NPA 2016-04)
CS ADR-DSN.H.420	Inner horizontal surface	Amended (NPA 2016-04)
CS ADR-DSN.H.445	Obstacle free zone (OFZ)	Amended (NPA 2016-04)
CS ADR-DSN.J.470	Non-instrument runways	Amended (NPA 2016-04)
CS ADR-DSN.J.475	Non-precision approach runways	Amended (NPA 2016-04)
CS ADR-DSN.J.480	Precision approach runways	Amended (NPA 2016-04)
CS ADR-DSN.J.485	Runways meant for take-off	Amended (NPA 2016-04)
CS ADR-DSN.J.486	Other objects (renumbered CS ADR-DSN.J.490)	Amended (NPA 2016-04)
CS ADR-DSN.J.487	Objects outside the obstacle limitation surfaces	Created (NPA 2016-04)
CS ADR-DSN.L.525	Runway designation marking	Amended (NPA 2016-04)
CS ADR-DSN.L.530	Runway centre line marking	Amended (NPA 2016-04)
CS ADR-DSN.L.535	Threshold marking	Amended (NPA 2016-04)
CS ADR-DSN.L.545	Touchdown zone marking	Amended (NPA 2016-04)
CS ADR-DSN.L.555	Taxiway centre line marking	Amended (NPA 2016-04)
CS ADR-DSN.L.570	Enhanced taxiway centre line marking	Amended (NPA 2016-04)

CS ADR-DSN.L.575	Runway-holding position marking	Amended (NPA 2016-04)
CS ADR-DSN.L.580	Intermediate holding position marking	Amended (NPA 2016-04)
CS ADR-DSN.L.585	VOR aerodrome checkpoint marking	Amended (NPA 2016-04)
CS ADR-DSN.L.597	Apron service road marking	Created (NPA 2016-04)
CS ADR-DSN.L.600	Road-holding position marking	Amended (NPA 2016-04)
CS ADR-DSN.L.605	Mandatory instruction marking	Amended (NPA 2016-04)
CS ADR-DSN.L.610	Information marking	Amended (NPA 2016-04)
CS ADR-DSN.M.625	Approach lighting systems	Amended (NPA 2016-04)
CS ADR-DSN.M.626	Simple approach lighting systems	Amended (NPA 2016-04)
CS ADR-DSN.M.630	Precision approach Category I lighting system	Amended (NPA 2016-04)
CS ADR-DSN.M.635	Precision approach Category II and III lighting system	Amended (NPA 2016-04)
CS ADR-DSN.M.645	Precision approach path indicator and Abbreviated precision approach path indicator (PAPI and APAPI)	Amended (NPA 2016-04)
CS ADR-DSN.M.650	Approach slope and elevation setting of light units for PAPI and APAPI	Amended (NPA 2016-04)
CS ADR-DSN.M.655	Obstacle protection surface for PAPI and APAPI	Amended (NPA 2016-04)
CS ADR-DSN.M.660	Circling guidance lights	Amended (NPA 2016-04)
CS ADR-DSN.M.675	Runway edge lights	Amended (NPA 2016-04)
CS ADR-DSN.M.680	Runway threshold and wing bar lights	Amended (NPA 2016-04)
CS ADR-DSN.M.685	Runway end lights	Amended (NPA 2016-04)
CS ADR-DSN.M.690	Runway centre line lights	Amended (NPA 2016-04)
CS ADR-DSN.M.695	Runway touchdown zone lights	Amended (NPA 2016-04)
CS ADR-DSN.M.696	Simple touchdown zone lights	Created (NPA 2016-04)
CS ADR-DSN.M.705	Stopway lights	Amended (NPA 2016-04)
CS ADR-DSN.M.710	Taxiway centre line lights	Amended (NPA 2016-04)
CS ADR-DSN.M.715	Taxiway centre line lights on taxiways, runways, rapid exit taxiways, or on other exit taxiways	Amended (NPA 2016-04)
CS ADR-DSN.M.720	Taxiway edge lights	Amended (NPA 2016-04)
CS ADR-DSN.M.725	Runway turn pad lights	Amended (NPA 2016-04)
CS ADR-DSN.M.730	Stop bars	Amended (NPA 2016-04)
CS ADR-DSN.M.735	Intermediate holding position lights	Amended (NPA 2016-04)
CS ADR-DSN.M.740	De-icing/anti-icing facility exit lights	Amended (NPA 2016-04)
CS ADR-DSN.M.745	Runway guard lights	Amended (NPA 2016-04)
CS ADR-DSN.M.750	Apron floodlighting	Amended (NPA 2016-04)
CS ADR-DSN.M.760	Advanced visual docking guidance system	Amended (NPA 2016-04)
CS ADR-DSN.M.770	Road-holding position light	Amended (NPA 2016-04)
CS ADR-DSN.M.771	No-entry bar	Created (NPA 2016-04)
CS ADR-DSN.N.775	General	Amended (NPA 2016-04)
CS ADR-DSN.N.780	Mandatory instruction signs	Amended (NPA 2016-04)
CS ADR-DSN.N.785	Information signs	Amended (NPA 2016-04)
CS ADR-DSN.Q.840	Objects to be marked and/or lighted within the lateral boundaries of the obstacle limitation surfaces	Amended (NPA 2016-04)
CS ADR-DSN.Q.841	Objects to be marked and/or lighted outside the lateral boundaries of the obstacle limitation surfaces	Created (NPA 2016-04)
CS ADR-DSN.Q.845	Marking of fixed objects	Created (NPA 2016-04)

CS ADR-DSN.Q.846	Lighting of fixed objects	Created (NPA 2016-04)
CS ADR-DSN.Q.847	Lighting of fixed objects with a height less than 45 m above ground level	Created (NPA 2016-04)
CS ADR-DSN.Q.848	Lighting of fixed objects with a height 45 m to a height less than 150 m above ground level	Created (NPA 2016-04)
CS ADR-DSN.Q.849	Lighting of fixed objects with a height 150 m or more above ground level	Created (NPA 2016-04)
CS ADR-DSN.Q.850	Lighting of other objects	Amended (NPA 2016-04)
CS ADR-DSN.Q.851	Marking and lighting of wind turbines	Created (NPA 2016-04)
CS ADR-DSN.Q.852	Marking and lighting of overhead wires, cables, supporting towers, etc.	Created (NPA 2016-04)
CS ADR-DSN.R.855	Closed runways and taxiways, or parts thereof	Amended (NPA 2016-04)
CS ADR-DSN.R.860	Non-load-bearing surfaces	Amended (NPA 2016-04)
CS ADR-DSN.S.880	Electrical power supply systems	Amended (NPA 2016-04)
CS ADR-DSN.S.890	Monitoring	Amended (NPA 2016-04)
CS ADR-DSN.S.895	Serviceability levels	Amended (NPA 2016-04)
CS ADR-DSN.T.900	Emergency access and service roads	Amended (NPA 2016-04)
CS ADR-DSN.T.915	Siting of equipment and installations on operational areas	Amended (NPA 2016-04)
CS ADR-DSN.U.930	Colours for aeronautical ground lights	Amended (NPA 2016-04)
CS ADR-DSN.U.935	Colours for markings, signs and panels	Amended (NPA 2016-04)
CS ADR-DSN.U.940	Aeronautical ground light characteristics	Amended (NPA 2016-04)
GM1 ADR-DSN.A.005	Aerodrome Reference Code	Amended (NPA 2016-04)
GM1 ADR-DSN.B.015	Number, siting, and orientation of runways	Amended (NPA 2016-04)
GM1 ADR-DSN.B.035	Length of the runway and declared distances	Amended (NPA 2016-04)
GM1 ADR-DSN.B.045	Width of runways	Amended (NPA 2016-04)
GM1 ADR-DSN.B055	Minimum distance between parallel instrument runways	Created (NPA 2016-04)
GM1 ADR-DSN.B.070	Sight distance for slopes of runways	Amended (NPA 2016-04)
GM1 ADR-DSN.B.085	Runway strength	Amended (NPA 2016-04)
GM1 ADR-DSN.B.090	Surface of runways	Amended (NPA 2016-04)
GM1 ADR-DSN.B.095	Runway turn pads	Amended (NPA 2016-04)
GM1 ADR-DSN.B.125	Runway shoulders	Amended (NPA 2016-04)
GM1 ADR-DSN.B.140	Strength of runway shoulders	Amended (NPA 2016-04)
GM1 ADR-DSN.B.165	Objects on runway strips	Amended (NPA 2016-04)
GM1 ADR-DSN.B.175	Grading of runway strips	Amended (NPA 2016-04)
GM1 ADR-DSN.B.180	Longitudinal Slopes on runway strips	Amended (NPA 2016-04)
GM1 ADR-DSN.B.190	Strength of runway strips	Amended (NPA 2016-04)
GM1 ADR-DSN.B.191	Drainage characteristics of the movement area and adjacent areas	Created (NPA 2016-04)
GM1 ADR-DSN.B.200	Stopways	Amended (NPA 2016-04)
GM1 ADR-DSN.B.205	Radio altimeter operating area	Amended (NPA 2016-04)
GM1 ADR-DSN.C.210	Runway end safety areas (RESA)	Amended (NPA 2016-04)
GM1 ADR-DSN.C.225	Clearing and grading of runway end safety areas	Amended (NPA 2016-04)
GM1 ADR-DSN.C.235	Strength of runway end safety areas	Amended (NPA 2016-04)
GM1 ADR-DSN.D.240	Taxiways general	Amended (NPA 2016-04)
GM1 ADR-DSN.D.250	Taxiways curves	Amended (NPA 2016-04)

GM1 ADR-DSN.D.255	Junction and intersection of taxiways	Amended (NPA 2016-04)
GM1 ADR-DSN.D.260	Taxiway minimum separation distance	Amended (NPA 2016-04)
GM1 ADR-DSN.D.285	Strength of taxiways	Amended (NPA 2016-04)
GM1 ADR-DSN.D.290	Surface of taxiways	Created (NPA 2016-04)
GM1 ADR-DSN.D.295	Rapid exit taxiways	Amended (NPA 2016-04)
GM1 ADR-DSN.D.305	Taxiway shoulders	Amended (NPA 2016-04)
GM1 ADR-DSN.D.310	Taxiway Strip	Amended (NPA 2016-04)
GM1 ADR-DSN.D.335	Holding bays, runway-holding positions, intermediate holding positions, and road-holding positions	Amended (NPA 2016-04)
GM1 ADR-DSN.D.340	Location of holding bays, runway-holding positions, intermediate holding positions, and road-holding positions	Amended (NPA 2016-04)
GM1 ADR-DSN.E.350	Size of aprons	Amended (NPA 2016-04)
GM1 ADR-DSN.E.360	Slopes on aprons	Amended (NPA 2016-04)
GM1 ADR-DSN.E.365	Clearance distances on aircraft stands	Amended (NPA 2016-04)
GM1 ADR-DSN.G.380	Location	Amended (NPA 2016-04)
GM1 ADR-DSN.G.385	Size of de-icing/anti-icing pads	Amended (NPA 2016-04)
GM1 ADR-DSN.H.410	Outer horizontal surface	Amended (NPA 2016-04)
GM1 ADR-DSN.H.420	Inner horizontal surface	Amended (NPA 2016-04)
GM1 ADR-DSN.H.440	Slewed take-off climb surface	Amended (NPA 2016-04)
GM1 ADR-DSN.H.445	Obstacle-free zone (OFZ)	Amended (NPA 2016-04)
GM1 ADR-DSN.J.470	Non-instrument runways	Amended (NPA 2016-04)
GM1 ADR-DSN.J.475	Non-precision approach runways	Amended (NPA 2016-04)
GM1 ADR-DSN.J.480	Precision approach runways	Amended (NPA 2016-04)
GM1 ADR-DSN.J.485	Runways meant for take-off	Amended (NPA 2016-04)
GM1 ADR-DSN.J.486	Other objects (renumbered GM1 ADR-DSN.J.490)	Created (NPA 2016-04)
GM1 ADR-DSN.J.487	Objects outside the obstacle limitation surfaces	Created (NPA 2016-04)
GM1 ADR-DSN.K.490	Wind direction indicator	Amended (NPA 2016-04)
GM1 ADR-DSN.K.515	Characteristics of signal panels and signal area	Amended (NPA 2016-04)
GM1 ADR-DSN.L.520	General – Colour and conspicuity	Amended (NPA 2016-04)
GM1 ADR-DSN.L.555	Taxiway centre line marking (only changed position in the text)	Amended (NPA 2016-04)
GM1 ADR-DSN.L.570	Enhanced taxiway centre line marking	Amended (NPA 2016-04)
GM1 ADR-DSN.L.585	VOR aerodrome checkpoint marking	Created (NPA 2016-04)
GM1 ADR-DSN.L.595	Apron safety lines	Created (NPA 2016-04)
GM1 ADR-DSN.L.597	Apron service road marking	Created (NPA 2016-04)
GM1 ADR-DSN.L.600	Road-holding position marking	Amended (NPA 2016-04)
GM1 ADR-DSN.M.625	Approach lighting systems	Amended (NPA 2016-04)
GM1 ADR-DSN.M.630	Precision approach Category I lighting system	Amended (NPA 2016-04)
GM1 ADR-DSN.M.635	Precision approach Category II and III lighting system	Amended (NPA 2016-04)
GM1 ADR-DSN.M.645	Precision approach path indicator and Abbreviated precision approach path indicator (PAPI and APAPI)	Amended (NPA 2016-04)
GM1 ADR-DSN.M.650	Approach slope and elevation setting of light units for PAPI and APAPI	Amended (NPA 2016-04)
GM1 ADR-DSN.M.690	Runway centre line lights	Amended (NPA 2016-04)
GM1 ADR-DSN.M.696	Simple Touchdown Zone Lights	Created (NPA 2016-04)

GM1 ADR-DSN.M.700	Rapid exit taxiway indicator lights	Amended (NPA 2016-04)
GM1 ADR-DSN.M.710	Taxiway centre line lights	Amended (NPA 2016-04)
GM1 ADR-DSN.M.730	Stop bars	Amended (NPA 2016-04)
GM1 ADR-DSN.M.745	Runway guard lights	Amended (NPA 2016-04)
GM1 ADR-DSN.M.771	No-entry bar	Created (NPA 2016-04)
GM1 ADR-DSN.N.775	General	Amended (NPA 2016-04)
GM1 ADR-DSN.N.785	Information signs	Created (NPA 2016-04)
GM1 ADR-DSN.P.820	Edge markers for snow-covered runways	Amended (NPA 2016-04)
GM1 ADR-DSN.P.825	Taxiway edge markers	Amended (NPA 2016-04)
GM1 ADR-DSN.Q.840	Objects to be marked and/or lighted within the lateral boundaries of the obstacle limitation surfaces	Created (NPA 2016-04)
GM1 ADR-DSN.Q.841	Objects to be marked and/or lighted outside the lateral boundaries of the obstacle limitation surfaces	Created (NPA 2016-04)
GM1 ADR-DSN.Q.845	Marking of fixed objects	Amended (NPA 2016-04)
GM1 ADR-DSN.Q.846	Lighting of fixed objects	Created (NPA 2016-04)
GM1 ADR-DSN.Q.847	Lighting of fixed objects with a height less than 45 m above ground level	Created (NPA 2016-04)
GM1 ADR-DSN.Q.848	Lighting of fixed objects with a height 45 m to a height less than 150 m above ground level	Created (NPA 2016-04)
GM1 ADR-DSN.Q.849	Lighting of fixed objects with a height 150 m or more above ground level	Created (NPA 2016-04)
GM1 ADR-DSN.Q.850	Lighting of other objects	Amended (NPA 2016-04)
GM1 ADR-DSN.Q.851	Marking and lighting of wind turbines	Created (NPA 2016-04)
GM1 ADR-DSN.Q.852	Marking and lighting of overhead wires, cables, supporting towers, etc	Created (NPA 2016-04)
GM1 ADR-DSN.R.860	Non-load-bearing surfaces	Amended (NPA 2016-04)
GM1 ADR-DSN.S.875	Electrical power supply systems for air navigation facilities	Amended (NPA 2016-04)
GM1 ADR-DSN.S.880	Electrical power supply	Amended (NPA 2016-04)
GM1 ADR-DSN.S.885	System design	Amended (NPA 2016-04)
GM1 ADR-DSN.S.890	Monitoring	Amended (NPA 2016-04)
GM1 ADR-DSN.S.895	Serviceability levels	Amended (NPA 2016-04)
GM1 ADR-DSN.T.900	Emergency access and service roads	Amended (NPA 2016-04)
GM1 ADR-DSN.T.910	Equipment frangibility requirements	Amended (NPA 2016-04)
GM1 ADR-DSN.T.915	Siting of equipment and installations on operational areas	Amended (NPA 2016-04)
GM1 ADR-DSN.T.920	Fencing	Amended (NPA 2016-04)
GM1 ADR-DSN.U.930	Colours for aeronautical ground lights	Amended (NPA 2016-04)

**CS-ADR-DSN Issue 2**
**Effective: See Decision 2015/001/R**

The following is a list of paragraphs affected by this amendment:

CS ADR-DSN.D.260	Taxiway minimum separation distance	Amended (NPA 2014-21)
CS ADR-DSN.G.400	Clearance distances on a de-icing/anti-icing pad	Amended (NPA 2014-21)

---

CS ADR-DSN.T.915	Siting of equipment and installations on operational areas	Amended (NPA 2014-21)
GM1 ADR-DSN.D.260	Taxiway minimum separation distance	Amended (NPA 2014-21)

## LIST OF ABBREVIATIONS

ED Decision 2017/021/R

### List of abbreviations

(used in CS-ADR-DSN)

ACN	Aircraft classification number
AGL	Above ground level
AGL	Aeronautical ground light
AIP	Aeronautical information publication
AIS	Aeronautical information services
APAPI	Abbreviated precision approach path indicator
ARC	Aerodrome reference code
ARIWS	Autonomous runway incursion warning systems
ASDA	Accelerate-stop distance available
A-SMGCS	Advanced surface movement guidance and control system
ATC	Air traffic control
ATIS	Automatic terminal information service
ATM	Air traffic management
ATS	Air traffic services
A-VDGS	Advanced visual docking guidance system
CBR	California bearing ratio
CCR	Constant current regulators
CIE	International Commission on Illumination (Commission Internationale de l'Éclairage)
CWY	Clearway
DH	Decision height
DME	Distance measuring equipment
ESDU	Engineering sciences data unit
FOD	Foreign object debris
FOV	Field of view
Hes	Height of equivalent elevated sign character
Hps	Height of pavement sign character
ICAO	International Civil Aviation Organization
ILS	Instrument landing system
IMC	Instrument meteorological conditions
ISO	International Organisation for Standardisation
LDA	Landing distance available
LED	Light-emitting diodes
LRST	Local runway safety team
MLS	Microwave landing system
MPD	Mean profile depth
MTD	Mean texture depth
NOTAM	Notice to airman
NU	Not usable
OCA/H	Obstacle clearance altitude/ height
OFZ	Obstacle-free zone



---

OLS	Obstacle limitation surface
OMGWS	Outer main gear wheel span
OPS	Obstacle protection surface
PAPI	Precision approach path indicator
PCN	Pavement classification number
PBN	Performance based navigation
PSV	Polished stone values
RELS	Runway entrance lights
RESA	Runway end safety area
RET	Rapid exit taxiway
RETILs	Rapid exit taxiway indicator lights
RFF	Rescue and firefighting
RFFS	Rescue and firefighting services
RP	Reference point
RVR	Runway visual range
RWSL	Runway status lights
RWY	Runway
SMGCS	Surface movement guidance and control system
SWY	Stopway
TDZ	Runway touchdown zone
THLs	Take-off hold lights
TODA	Take-off distance available
TORA	Take-off run available
UPS	Uninterruptible power supply
VMC	Visual meteorological conditions
VOR	VHF Omnidirectional radio range
WGS-84	World geodetic system – 1984

## CHAPTER A — GENERAL

### CS ADR-DSN.A.001 Applicability

*ED Decision 2021/004/R*

The certification specifications (CSs) and the related guidance material (GM) are applicable to aerodromes that fall within the scope of Regulation (EU) 2018/1139 (Basic Regulation).

[Issue: ADR-DSN/5]

### GM1 ADR-DSN.A.001 Applicability

*ED Decision 2021/004/R*

At an aerodrome that falls within the scope of the Basic Regulation and has more than one runway, at least one runway should meet the criteria contained in Article 2 of the Basic Regulation. However, it is not compulsory for other ‘types’ of runways at an aerodrome to meet the criteria of Article 2 of the Basic Regulation. Such runways may be non-instrument runways, unpaved runways, shorter than 800 m runways, runways which are not open to public use or for commercial air transport. The certification specifications and guidance material are applicable also to those runways.

[Issue: ADR-DSN/5]

### CS ADR-DSN.A.002 Definitions

*ED Decision 2021/004/R1/004/R*

For the purposes of CS-ADR-DSN, the following definitions should apply:

‘Accuracy’ means a degree of conformance between the estimated or measured value and the true value.

‘Aerodrome’ means a defined area (including any buildings, installations and equipment) on land or water or on a fixed offshore or floating structure intended to be used either wholly or in part for the arrival, departure and surface movement of aircraft.

‘Aerodrome beacon’ means an aeronautical beacon used to indicate the location of an aerodrome from the air.

‘Aerodrome elevation’ means the elevation of the highest point of the landing area.

‘Aerodrome equipment’ means any equipment, apparatus, appurtenance, software or accessory, that is used or intended to be used to contribute to the operation of aircraft at an aerodrome.

‘Aerodrome operator’ means any legal or natural person, operating or proposing to operate one or more aerodromes.

‘Aerodrome traffic density’ means the number of movements in the mean busy hour and is the arithmetic mean over the year of the number of movements in the daily busiest hour. Movement is either a take-off or a landing:

- (a) — Light. Where the number of movements in the mean busy hour is not greater than 15 per runway or typically less than 20 total aerodrome movements.
- (b) — Medium. Where the number of movements in the mean busy hour is of the order of 16 to 25 per runway or typically between 20 to 35 total aerodrome movements.
- (c) — Heavy. Where the number of movements in the mean busy hour is of the order of 26 or more per runway or typically more than 35 total aerodrome movements.

‘Aeronautical beacon’ means an aeronautical ground light visible at all azimuths, either continuously or intermittently, to designate a particular point on the surface of the earth.

‘Aeronautical ground light’ means any light specially provided as an aid to air navigation, other than a light displayed on an aircraft.

‘Aeroplane’ means a power-driven heavier-than-air aircraft, deriving its lift in flight chiefly from aerodynamic reactions on surfaces which remain fixed under given conditions of flight;

‘Aeroplane reference field length’ means the minimum field length required for take-off at maximum certificated take-off mass, sea level, standard atmospheric conditions, still air and zero runway slope, as shown in the appropriate aeroplane flight manual prescribed by the certifying authority or equivalent data from the aeroplane manufacturer. Field length means balanced field length for aeroplanes, if applicable, or take-off distance in other cases.

‘Arresting system’ means a system designed to decelerate an aeroplane overrunning the runway.

‘Autonomous runway incursion warning system (ARIWS)’ means a system which provides autonomous detection of a potential incursion or of the occupancy of an active runway and a direct warning to a flight crew or a vehicle operator.

‘Aircraft’ means a machine that can derive support in the atmosphere from the reactions of the air other than the reactions of the air against the earth’s surface.

‘Aircraft classification number (ACN)’ means the number expressing the relative effect of an aircraft on a pavement for a specified standard subgrade category.

‘Aircraft stand’ means a designated area on an apron intended to be used for parking an aircraft.

‘Aircraft stand taxilane’ means a portion of an apron designated as a taxiway and intended to provide access to aircraft stands only.

‘Apron’ means a defined area intended to accommodate aircraft for purposes of loading or unloading passengers, mail or cargo, fuelling, parking, or maintenance.

‘Apron service road’ means a road located on or adjacent to an apron, intended for the exclusive use of vehicles.

‘Apron taxiway’ means a portion of a taxiway system located on an apron and intended to provide a through taxi-route across the apron.

‘Balked landing’ means a landing manoeuvre that is unexpectedly discontinued at any point below the obstacle clearance altitude/height (OCA/H).

‘Barrette’ means three or more aeronautical ground lights closely spaced in a transverse line so that from a distance they appear as a short bar of light.

‘Certification specifications’ mean technical standards adopted by the Agency indicating means to show compliance with Regulation (EU) No 2018/1139 and its Implementing Rules and which can be used by an organisation for the purpose of certification.

‘Clearway’ means a defined rectangular area on the ground or water under the control of the appropriate entity, selected or prepared as a suitable area over which an aeroplane may make a portion of its initial climb to a specified height.

‘Critical Area’ means an area of defined dimensions extending about the ground equipment of a precision instrument approach within which the presence of vehicles or aircraft will cause unacceptable disturbance of the guidance signals.

‘Datum’ means any quantity or set of quantities that may serve as a reference or basis for the calculation of other quantities (ISO 19104).

‘Declared distances’ means:

- ‘Take-off run available (TORA)’ means the length of runway declared available and suitable for the ground run of an aeroplane taking off.
- ‘Take-off distance available (TODA)’ means the length of the take-off run available plus the length of the clearway if provided.
- ‘Accelerate-stop distance available (ASDA)’ means the length of the take-off run available plus the length of the stopway if provided.
- ‘Landing distance available (LDA)’ means the length of runway which is declared available and suitable for the ground run of an aeroplane landing.

‘De-icing/anti-icing facility’ means a facility where frost, ice, or snow is removed (de-icing) from the aeroplane to provide clean surfaces, and/or where clean surfaces of the aeroplane receive protection (anti-icing) against the formation of frost or ice and accumulation of snow or slush for a limited period of time.

‘De-icing/anti-icing pad’ means an area comprising an inner area for the parking of an aeroplane to receive de-icing/anti-icing treatment and an outer area for the manoeuvring of two or more mobile de-icing/anti-icing equipment.

‘Dependent parallel approaches’ means simultaneous approaches to parallel or near-parallel instrument runways where radar separation minima between aircraft on adjacent extended runway centre lines are prescribed.

‘Displaced threshold’ means a threshold not located at the extremity of a runway.

‘Fixed light’ means a light having constant luminous intensity when observed from a fixed point.

‘Foreign object debris (FOD)’ means an inanimate object within the movement area which has no operational or aeronautical function and which has the potential to be a hazard to aircraft operations.

‘Frangibility’ means the ability of an object to retain its structural integrity and stiffness up to a specified maximum load but when subject to a load greater than specified or struck by an aircraft will break, distort or yield in a manner designed to present minimum hazard to an aircraft.

‘Frangible object’ means an object of low mass designed to break, distort or yield on impact so as to present the minimum hazard to aircraft.

‘Frost’ means ice crystals formed from airborne moisture on a surface whose temperature is below freezing; frost differs from ice in that the frost crystals grow independently and therefore have a more granular texture.

Note 1: ‘Below freezing’ refers to air temperature equal to or less than the freezing point of water (0 degree Celsius).

Note 2: Under certain conditions, frost can cause the surface to become very slippery and it is then reported appropriately as downgraded RWYCC.

‘Graded area’ means that part of the runway strip cleared of all obstacles, except for specified items and graded, intended to reduce the risk of damage to an aircraft running off the runway.

‘Hazard beacon’ means an aeronautical beacon used to designate a danger to air navigation.

‘Holding bay’ means a defined area where aircraft can be held, or bypassed to facilitate efficient surface movement of aircraft.

‘Holdover time’ means the estimated time during which the anti-icing fluid (treatment) will prevent the formation of ice and frost and the accumulation of snow on the protected (treated) surfaces of an aeroplane.

‘Hot spot’ means a location on an aerodrome movement area with a history or potential risk of collision or runway incursion, and where heightened attention by pilots/drivers is necessary.

‘Ice’ means water that has frozen or compacted snow that has transitioned into ice in cold and dry conditions.

‘Identification beacon’ means an aeronautical beacon emitting a coded signal by means of which a particular point of reference can be identified.

‘Independent parallel approaches’ means simultaneous approaches to parallel or near-parallel instrument runways where radar separation minima between aircraft on adjacent extended runway centre lines are not prescribed.

‘Independent parallel departures’ means simultaneous departures from parallel or near-parallel instrument runways.

‘Instrument runway’ means one of the following types of runways intended for the operation of aircraft using instrument approach procedures:

1. ‘Non-precision approach runway’: a runway served by visual aids and at least one non-visual aid, intended for landing operations following a type A instrument approach operation.
2. ‘Precision approach runway, Category I’: a runway served by visual aids and at least one non-visual aid, intended for landing operations following a type B CAT I instrument approach operation.
3. ‘Precision approach runway, Category II’: a runway served by visual aids and at least one non-visual aid, intended for landing operations following a type B CAT II instrument approach operation.
4. ‘Precision approach runway, Category III’: a runway served by visual aids and at least one non-visual aid, intended for landing operations following a type B CAT IIIA, IIIB or IIIC instrument approach operation to and along the surface of the runway.

‘Intermediate holding position’ means a designated position intended for traffic control at which taxiing aircraft and vehicles should stop and hold until further cleared to proceed when so instructed by the appropriate air traffic control unit.

‘Isolated Aircraft Parking Position’ means an area suitable for the parking of an aircraft which is known or suspected to be the subject of unlawful interference, or for other reasons needs isolation from normal aerodrome activities.

‘Landing area’ means that part of a movement area intended for the landing or take-off of aircraft.

‘Landing direction indicator’ means a device to indicate visually the direction currently designated for landing and for take-off.

‘Manoeuvring area’ means that part of an aerodrome to be used for the take-off, landing and taxiing of aircraft, excluding aprons.

‘Marker’ means an object displayed above ground level in order to indicate an obstacle or delineate a boundary.

‘Marking’ means a symbol or group of symbols displayed on the surface of the movement area in order to convey aeronautical information.

‘Movement area’ means that part of an aerodrome to be used for the take-off, landing and taxiing of aircraft, consisting of the manoeuvring area and the apron(s).

‘Non-instrument runway’ means a runway intended for the operation of aircraft using visual approach procedures.

‘Obstacle’ means all fixed (whether temporary or permanent) and mobile objects, or parts thereof, that:

- are located on an area intended for the surface movement of aircraft; or
- extend above a defined surface intended to protect aircraft in flight; or
- stand outside those defined surfaces and that have been assessed as being a hazard to air navigation.

‘Obstacle-free zone (OFZ)’ means the airspace above the inner approach surface, inner transitional surfaces, and balked landing surface and that portion of the strip bounded by these surfaces, which is not penetrated by any fixed obstacle other than a low-mass and frangibly mounted one required for air navigation purposes.

‘Obstacle limitation surface’ means a surface that defines the limits to which objects may project into the airspace.

‘Obstacle protection surface’ means a surface established for visual approach slope indicator system above which objects or extensions of existing objects shall not be permitted except when, in the opinion of the appropriate authority, the new object or extension would be shielded by an existing immovable object.

‘Operator’ means any legal or natural person, operating or proposing to operate one or more aircraft or one or more aerodromes.

‘Outer main gear wheel span (OMGWS)’ means the distance between the outside edges of the main gear wheels.

‘Paved runway’ means a runway with a hard surface that is made up of engineered and manufactured materials bound together so it is durable and either flexible or rigid.

‘Pavement classification number (PCN)’ means a number expressing the bearing strength of a pavement for unrestricted operations.

‘Precision approach runway’, see ‘instrument runway’.

‘Primary runway(s)’ means runway(s) used in preference to others whenever conditions permit.

‘Rapid exit taxiway’ means a taxiway connected to a runway at an acute angle and designed to allow landing aeroplanes to turn off at higher speeds than are achieved on other exit taxiways thereby minimising runway occupancy times;

‘Road’ means an established surface route on the movement area meant for the exclusive use of vehicles.

‘Road-holding position’ means a designated position at which vehicles may be required to hold.

‘Runway’ means a defined rectangular area on a land aerodrome prepared for the landing and take-off of aircraft.

‘Runway end safety area (RESA)’ means an area symmetrical about the extended runway centre line and adjacent to the end of the strip primarily intended to reduce the risk of damage to an aeroplane undershooting or overrunning the runway.

‘Runway guard lights’ means a light system intended to caution pilots or vehicle drivers that they are about to enter an active runway.

‘Runway-holding position’ means a designated position intended to protect a runway, an obstacle limitation surface, or an ILS/MLS critical/sensitive area at which taxiing aircraft and vehicles should stop and hold, unless otherwise authorised by the aerodrome control tower.

‘Runway strip’ means a defined area including the runway and stopway, if provided, intended:

- to reduce the risk of damage to aircraft running off a runway; and
- to protect aircraft flying over it during take-off or landing operations.

‘Runway turn pad’ means a defined area on a land aerodrome adjacent to a runway for the purpose of completing a 180-degree turn on a runway.

‘Runway type’ means instrument runway or non-instrument runway.

‘Runway visual range (RVR)’ means the range over which the pilot of an aircraft on the centre line of a runway can see the runway surface markings or the lights delineating the runway or identifying its centre line.

‘Sensitive area’ means an area extending beyond the Critical Area where the parking and/or movement of aircraft or vehicles will affect the guidance signal to the extent that it may be rendered unacceptable to aircraft using the signal.

‘Shoulder’ means an area adjacent to the edge of a pavement so prepared as to provide a transition between the pavement and the adjacent surface.

‘Sign’:

- Fixed message sign means a sign presenting only one message;
- Variable message sign means a sign capable of presenting several predetermined messages or no message, as applicable.

‘Signal area’ means an area on an aerodrome used for the display of ground signals.

‘Slush’ means snow that is so water-saturated that water will drain from it when a handful is picked up or will splatter if stepped on forcefully.

‘Snow’ (on the ground):

- ‘Dry snow’ means snow from which a snowball cannot readily be made.
- ‘Wet snow’ means snow that contains enough water to be able to make a well-compacted, solid snowball, but water will not squeeze out.
- ‘Compacted snow’ means snow that has been compacted into a solid mass such that aeroplane tyres, at operating pressures and loadings, will run on the surface without significant further compaction or rutting of the surface.

‘Standing water’ means water of depth greater than 3 mm.

Note: Running water of depth greater than 3 mm is reported as ‘standing water’ by convention.

‘Stopway’ means a defined rectangular area on the ground at the end of take-off run available prepared as a suitable area in which an aircraft can be stopped in the case of an abandoned take-off.

‘Surface friction’ means the resistance offered to the movement of one body past a surface with which it is in contact.

‘Switch-over time (light)’ means the time required for the actual intensity of a light measured in a given direction to fall from 50 % and recover to 50 % during a power supply changeover, when the light is being operated at intensities of 25 % or above.

‘Take-off runway’ means a runway intended for take-off only.

‘Taxiway’ means a defined path on a land aerodrome established for the taxiing of aircraft and intended to provide a link between one part of the aerodrome and another, including:

- Aircraft stand taxilane;
- Apron taxiway;
- Rapid exit taxiway.

‘Taxiway intersection’ means a junction of two or more taxiways.

‘Taxiway strip’ means an area including a taxiway intended to protect an aircraft operating on the taxiway and to reduce the risk of damage to an aircraft accidentally running off the taxiway.

‘Threshold’ means the beginning of that portion of the runway usable for landing.

‘Touchdown zone’ means the portion of a runway, beyond the threshold, where landing aeroplanes are intended to first contact the runway.

‘Type A instrument approach operation’ means an instrument approach operation with a minimum descent height or decision height at or above 75 m (250 ft);

‘Type B instrument approach operation’ means an instrument approach operation with a decision height below 75 m (250 ft). Type B instrument approach operations are categorised as follows:

1. Category I (CAT I): a decision height not lower than 60 m (200 ft) and with either a visibility not less than 800 m or a runway visual range not less than 550 m;
2. Category II (CAT II): a decision height lower than 60 m (200 ft), but not lower than 30 m (100 ft) and a runway visual range not less than 300 m;
3. Category IIIA (CAT IIIA): a decision height lower than 30 m (100 ft) or no decision height and a runway visual range not less than 175 m;
4. Category IIIB (CAT IIIB): a decision height lower than 15 m (50 ft) or no decision height and a runway visual range less than 175 m, but not less than 50 m;
5. Category IIIC (CAT IIIC): no decision height and no runway visual range limitation.

‘Visual aids’ means indicators and signalling devices, markings, lights, signs and markers or combinations thereof.

‘Visual approach slope indicator system’ means a system of lights arranged to provide visual descent guidance information during the approach to a runway.

‘Wet ice’ means ice with water on top of it or ice that is melting.

Note: Freezing precipitation can lead to runway conditions associated with wet ice from an aeroplane performance point of view. Wet ice can cause the surface to become very slippery. It is then reported appropriately as downgraded RWYCC.

[Issue: ADR-DSN/3]

[Issue: ADR-DSN/4]

[Issue: ADR-DSN/5]



## GM1 ADR-DSN.A.002 Definitions

*ED Decision 2014/013/R*

intentionally left blank

## CS ADR-DSN.A.005 Aerodrome reference code (ARC)

*ED Decision 2017/021/R*

- (a) An aerodrome reference code, consisting of a code number and letter which is selected for aerodrome planning purposes, should be determined in accordance with the characteristics of the aeroplane for which an aerodrome facility is intended.
- (b) The aerodrome reference code numbers and letters should have the meanings assigned to them in Table A-1.
- (c) The code number for element 1 should be determined from Table A-1, by selecting the code number corresponding to the highest value of the aeroplane reference field lengths of the aeroplanes for which the runway is intended. The determination of the aeroplane reference field length is solely for the selection of a code number and is not intended to influence the actual runway length provided.
- (d) The code letter for element 2 should be determined from Table A-1, by selecting the code letter which corresponds to the greatest wingspan of the aeroplanes for which the facility is intended.

Code element 1	
Code number	Aeroplane reference field length
1	Less than 800 m
2	800 m up to but not including 1 200 m
3	1 200 m up to but not including 1 800 m
4	1 800 m and over

Code element 2	
Code letter	Wingspan
A	Up to but not including 15 m
B	15 m up to but not including 24 m
C	24 m up to but not including 36 m
D	36 m up to but not including 52 m
E	52 m up to but not including 65 m
F	65 m up to but not including 80 m

**Table A-1 Aerodrome reference code**

[Issue: ADR-DSN/3]

[Issue: ADR-DSN/4]

## GM1 ADR-DSN.A.005 Aerodrome reference code (ARC)

*ED Decision 2017/021/R*

- (a) The intent of the reference code is to provide a simple method for interrelating the numerous specifications concerning the characteristics of aerodromes so as to provide a series of aerodrome facilities that are suitable for the aeroplanes that are intended to operate at the aerodrome. The code is not intended to be used for determining runway length or pavement strength requirements. The code is composed of two elements which are related to the aeroplane performance characteristics and dimensions.

- (b) Element 1 is a number based on the aeroplane reference field length, and element 2 is a letter based on the aeroplane wingspan. The code letter or number within an element selected for design purposes is related to the critical aeroplane characteristics for which the facility is provided. When applying CS-ADR-DSN text, the aeroplanes which the aerodrome is intended to serve, are first identified and then the two elements of the code.
- (c) In addition to the reference code, other aircraft characteristics, such as aircraft length and tail height, may also have an impact on the design of an aerodrome. Additionally, some characteristics of a piece of infrastructure are directly related to one element of the code (wingspan or wheel span) but are not impacted by other. The aerodrome designer should consider all the relationships between aircraft characteristics and aerodromes and piece of infrastructures characteristics.
- (d) It is not intended that the specifications deriving from the aerodrome reference code limit or regulate the operation of an aircraft.
- (e) It is recognised that not all areas of the aerodrome should need to correspond to the critical aeroplane that determines the Aerodrome Reference Code. Elements of the aerodrome infrastructure that do not meet the requirements of the Aerodrome Reference Code for the design aeroplane should be designated with an appropriate code letter for its dimensions. Limitations should be identified to aircraft size permitted or operating limitations. ICAO, Annex 14 does not provide sufficient flexibility for infrastructure intended for different sizes of aircraft. It only addresses the 'design aircraft'. This enables all areas of the aerodrome to reflect the aerodrome reference code.
- (f) Further guidance on aerodrome reference code and on planning for aeroplanes with wingspans greater than 80 m is given in ICAO Doc 9157, Aerodrome Design Manual, Part 1, Runways, and Part 2, Taxiways, Aprons and Holding Bays.

Additional guidance on determining the runway length is given in ICAO Doc 9157, Aerodrome Design Manual, Part 1, Runways.

Note: References to the ICAO documents provided in CS-ADR-DSN are made for additional guidance. Changes in the CS-ADR-DSN regarding the aerodrome reference code are not yet fully reflected in these documents.

[Issue: ADR-DSN/3]

[Issue: ADR-DSN/4]

## CS ADR-DSN.A.010

ED Decision 2014/013/R

intentionally left blank

## GM1 ADR-DSN.A.010

ED Decision 2014/013/R

intentionally left blank

## CHAPTER B — RUNWAYS

### CS ADR-DSN.B.015 Number, siting and orientation of runways

ED Decision 2014/013/R

The number and orientation of runways at an aerodrome should be such that the usability factor of the aerodrome is optimised taking into account that safety is not compromised.

### GM1 ADR-DSN.B.015 Number, siting, and orientation of runways

ED Decision 2017/021/R

- (a) In practice the number and orientation of runways at an aerodrome should normally be such that the usability factor of the aerodrome would normally be not less than 95 % for the aeroplanes that the aerodrome is intended to serve.
- (b) Many factors affect the determination of the orientation, siting, and number of runways:
- (1) The wind distribution (to minimise crosswinds liable to affect runways);
    - (i) Wind statistics used for the calculation of the usability factor are normally available in ranges of speed and direction, and the accuracy of the results obtained depends, to a large extent, on the assumed distribution of observations within these ranges. In the absence of any sure information as to the true distribution, it is usual to assume a uniform distribution since, in relation to the most favourable runway orientations, this generally results in a slightly conservative usability factor.
    - (ii) The maximum mean crosswind components given in [GM1 ADR-DSN.B.020](#), refer to normal circumstances. There are some factors which may require that a reduction of those maximum values be taken into account at a particular aerodrome. These include:
      - A. the wide variations which may exist, in handling characteristics and maximum permissible crosswind components, among diverse types of aeroplanes (including future types) within each of the three groups given in [GM1 ADR-DSN.B.020](#);
      - B. prevalence and nature of gusts;
      - C. prevalence and nature of turbulence;
      - D. the availability of a secondary runway;
      - E. the width of runways;
      - F. the runway surface conditions — water, snow, and ice on the runway materially reduce the allowable crosswind component; and
      - G. the strength of the wind associated with the limiting crosswind component.
  - (2) The need to facilitate the provision of approaches conforming to the approach surface specifications, ensuring that obstacles in these areas or other factors should not restrict the operation of the aeroplanes for which the runway is intended. This may relate to individual obstacles or local geography (e.g. high ground).
  - (3) The need to minimise interference with areas approved for residential use and other noise-sensitive areas close to the aerodrome.

- (4) The need to avoid the turbulence impacts of buildings on or close to the aerodrome.
  - (5) Type of operation. Attention should be paid in particular to whether the aerodrome is to be used in all meteorological conditions or only in visual meteorological conditions, and whether it is intended for use by day and night, or only by day.
  - (6) Topography of the aerodrome site, its approaches, and surroundings, particularly:
    - (i) compliance with the obstacle limitation surfaces;
    - (ii) current and future land use. The orientation and layout should be selected so as to protect as far as possible, the particularly sensitive areas, such as residential, school and hospital zones, from the discomfort caused by aircraft noise. Detailed information on this topic is provided in ICAO Doc 9184, Airport Planning Manual, Part 2, Land Use and Environmental Control and in ICAO Doc 9829, Guidance on the Balanced Approach to Aircraft Noise Management;
    - (iii) current and future runway lengths to be provided;
    - (iv) construction costs; and
    - (v) possibility of installing suitable non-visual and visual aids for approach-to-land.
  - (7) Air traffic in the vicinity of the aerodrome, particularly:
    - (i) proximity of other aerodromes or ATS routes;
    - (ii) traffic density; and
    - (iii) air traffic control and missed approach procedures.
- (c) The number of runways to be provided in each direction depends on the number of aircraft movements to be catered for.
- (d) Whatever the factors that determine the runway orientation, the siting, and orientation of runways at an aerodrome should where possible, be such that safety is optimised.
- (e) One important factor is the usability factor, as determined by the wind distribution which is specified hereunder. Another important factor is the alignment of the runway to facilitate the provision of approaches conforming to the approach surface specifications in [CS ADR-DSN.H.425](#). Further guidance on these and other factors is given in ICAO Annex 14, Attachment A, Section 1. When a new instrument runway is being located, particular attention needs to be given to areas over which aeroplanes should be required to fly when following instrument approach and missed approach procedures so as to ensure that obstacles in these areas or other factors should not restrict the operation of the aeroplanes for which the runway is intended.
- (f) The selection of data to be used for the calculation of the usability factor should be based on reliable wind distribution statistics that extend over as long a period of time as possible, preferably of not less than five years. The observations used should be made at least eight times daily and spaced at equal intervals of time.

[Issue: ADR-DSN/3]

[Issue: ADR-DSN/4]

## CS ADR-DSN.B.020 Choice of maximum permissible crosswind components

ED Decision 2014/013/R

intentionally left blank

## GM1 ADR-DSN.B.020 Choice of maximum permissible crosswind components

ED Decision 2014/013/R

- (a) In the application of [GM1 ADR-DSN.B.015\(a\)](#) it should be assumed that landing or take-off of aeroplanes is, in normal circumstances, precluded when the crosswind component exceeds:
- (1) 37 km/h (20 kt) in the case of aeroplanes whose reference field length is 1 500 m or over, except that when poor runway braking action owing to an insufficient longitudinal coefficient of friction is experienced with some frequency, a crosswind component not exceeding 24 km/h (13 kt) should be assumed;
  - (2) 24 km/h (13 kt) in the case of aeroplanes whose reference field length is 1 200 m or up to but not including 1 500 m; and
  - (3) 19 km/h (10 kt) in the case of aeroplanes whose reference field length is less than 1 200 m.

## CS ADR-DSN.B.025 Data to be used

ED Decision 2014/013/R

intentionally left blank

## GM1 ADR-DSN.B.025 Data to be used

ED Decision 2017/021/R

intentionally left blank

[Issue: ADR-DSN/4]

## CS ADR-DSN.B.030 Runway threshold

ED Decision 2014/013/R

- (a) A threshold should be provided on a runway.
- (b) A threshold needs not to be provided on a take-off runway.
- (c) A threshold should be located at the extremity of a runway unless operational considerations justify the choice of another location.
- (d) When it is necessary to displace a threshold, either permanently or temporarily, from its normal location, account should be taken of the various factors which may have a bearing on the location of the threshold.
- (e) When the threshold is displaced, the threshold location should be measured at the inner edge of the threshold marking (the transverse stripe across the runway).

## GM1 ADR-DSN.B.030 Runway threshold

ED Decision 2021/004/R

- (a) Additional distance should be provided to meet the requirements of the runway end safety area as appropriate.
- (b) Where this displacement is due to an unserviceable runway condition, a cleared and graded area of at least 60 m in length should be available between the unserviceable area and the displaced threshold.
- (c) Guidance Material on the survey requirements for aerodromes is provided in the ICAO World Geodetic system – 1984 (WGS-84) Manual, notably in Section 5.3. However, this guidance does not accurately define the survey locations for the runway edge or the runway threshold because, in both cases, the measurement point is not the centre of the relevant paint marking.
- (d) Location of threshold:
  - (1) The threshold is normally located at the extremity of a runway if there are no obstacles penetrating above the approach surface. In some cases, however, due to local conditions it may be desirable to displace the threshold permanently (see below). When studying the location of a threshold, consideration should also be given to the height of the ILS reference datum, and/or MLS approach reference datum, and the determination of the obstacle clearance limits. Specifications concerning the height of the ILS reference datum and MLS approach reference datum are given in ICAO Annex 10, Volume I.
  - (2) In determining that no obstacles penetrate above the approach surface, account should be taken of mobile objects (vehicles on roads, trains, etc.) at least within that portion of the approach area within 1 200 m longitudinally from the threshold and of an overall width of not less than 150 m.
- (e) Displaced threshold:
  - (1) If an object extends above the approach surface and the object cannot be removed, consideration should be given to displacing the threshold permanently.
  - (2) To meet the obstacle limitation objectives of the certification specifications prescribed in Chapter H, the threshold should ideally be displaced down the runway for the distance necessary to provide that the approach surface is cleared of obstacles.
  - (3) However, displacement of the threshold from the runway extremity should inevitably cause reduction of the landing distance available, and this may be of greater operational significance than penetration of the approach surface by marked and lighted obstacles. A decision to displace the threshold, and the extent of such displacement, should, therefore, have regard to an optimum balance between the considerations of clear approach surfaces and adequate landing distance. In deciding this question, account should need to be taken of the types of aeroplanes which the runway is intended to serve, the limiting visibility and cloud base conditions under which the runway should be used, the position of the obstacles in relation to the threshold and extended centre line, and, in the case of a precision approach runway, the significance of the obstacles to the determination of the obstacle clearance limit.
  - (4) Notwithstanding the consideration of landing distance available, the selected position for the threshold should not be such that the obstacle-free surface to the threshold is steeper than 3.3 % where the code number is 4 or steeper than 5 % where the code number is 3.

- (5) In the event of a threshold being located according to the criteria for obstacle-free surfaces in the preceding paragraph, the obstacle marking requirements of Chapter Q should continue to be met in relation to the displaced threshold.
- (6) Depending on the length of the displacement, the RVR at the threshold could differ from that at the beginning of the runway for take-offs. The use of red runway edge lights with photometric intensities lower than the nominal value of 10 000 cd for white lights increases that phenomenon.

[Issue: ADR-DSN/4]

[Issue: ADR-DSN/5]

## CS ADR-DSN.B.035 Length of runway and declared distances

ED Decision 2016/027/R

- (a) The length of a runway should provide declared distances adequate to meet the operational requirements for the aircraft which the runway is intended to serve.
- (b) The following distances should be calculated to the nearest metre for each runway:
  - (1) Take-off run available;
  - (2) Take-off distance available;
  - (3) Accelerate-stop distance available; and
  - (4) Landing distance available.
- (c) The length of the runway is measured from the start of the runway pavement or where a transverse stripe marking is provided to indicate threshold displacement, at the inner edge of the transverse stripe across the runway.

[Issue: ADR-DSN/3]

## GM1 ADR-DSN.B.035 Length of the runway and declared distances

ED Decision 2016/027/R

- (a) Length of the runway:
  - (1) This specification does not necessarily mean providing for operations by the critical aeroplane at its maximum mass.
  - (2) Both take-off and landing requirements need to be considered when determining the length of runway to be provided and the need for operations to be conducted in both directions of the runway.
  - (3) Local conditions that may need to be considered include elevation, temperature, runway slope, humidity, and the runway surface characteristics.
  - (4) When performance data on aeroplanes for which the runway is intended, are not known, guidance on the determination of the actual length of a primary runway by application of general correction factors is given in ICAO Doc 9157, Aerodrome Design Manual, Part 1, Runways.
  - (5) Except as provided in [GM1 ADR-DSN.B.040](#), the actual runway length to be provided for a runway should be adequate to meet the operational requirements of the aeroplanes for which the runway is intended, and should be not less than the longest length

determined by applying the corrections for local conditions to the operations and performance characteristics of the relevant aeroplanes.

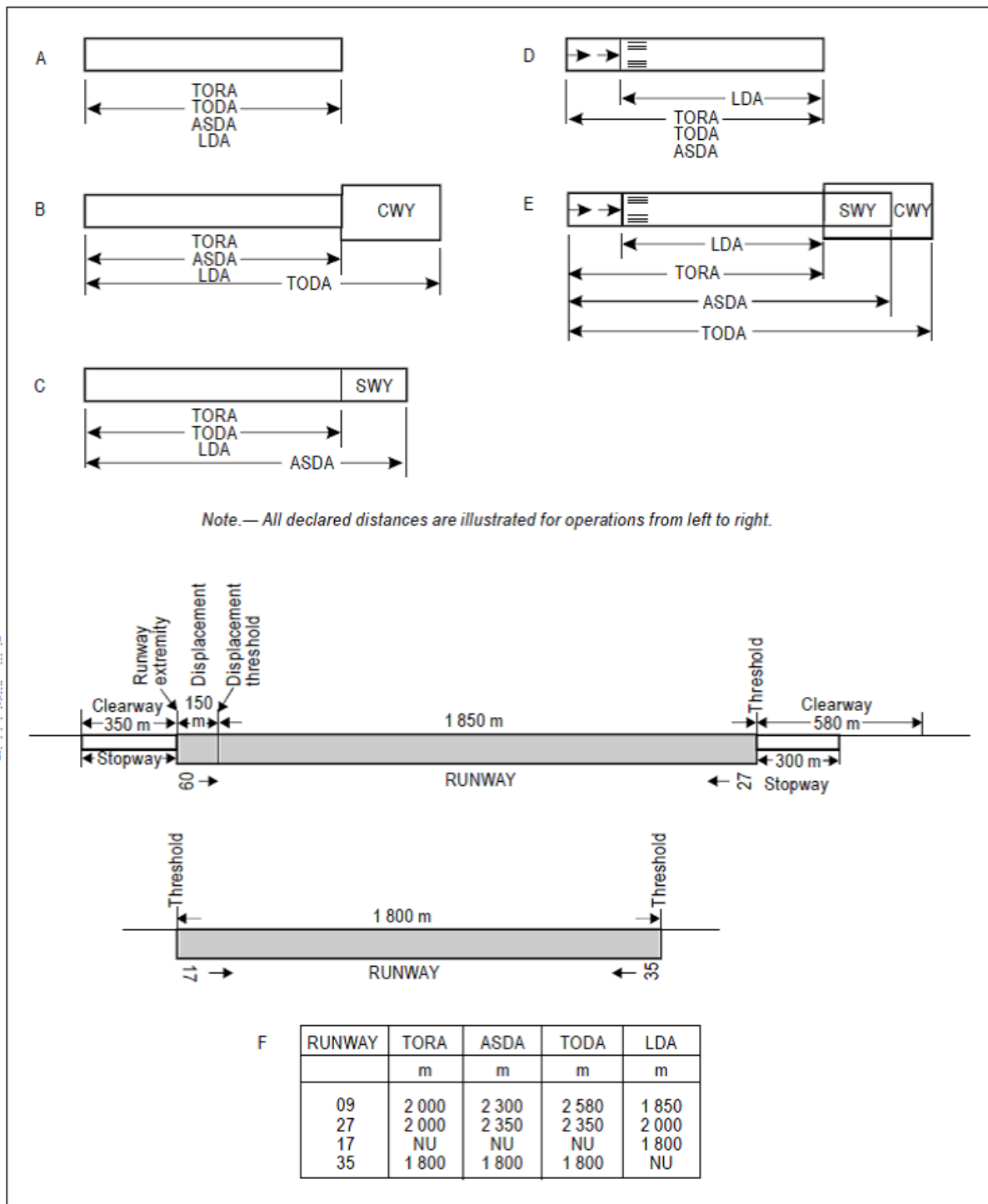


Figure GM-B-1. Illustration of declared distances

[Issue: ADR-DSN/3]



## CS ADR-DSN.B.040 Runways with stopways or clearways

ED Decision 2014/013/R

The length(s) of a stopway or clearway, where provided, should be of adequate distance to meet the operational requirements for the aircraft which the runway is intended to serve.

## GM1 ADR-DSN.B.040 Runways with stopways, or clearways

ED Decision 2014/013/R

Where a runway is associated with a stopway or clearway, an actual runway length less than that resulting from application of [GM1 ADR-DSN.B.035](#) as appropriate, may be considered satisfactory but, in such a case, any combination of runway, stopway, and clearway provided should permit compliance with the operational requirements for take-off and landing of the aeroplanes the runway is intended to serve.

## CS ADR-DSN.B.045 Width of runways

ED Decision 2017/021/R

- (a) The width of a runway should be not less than the appropriate dimension specified in the Table B-1.

Code number	Outer Main Gear Wheel Span (OMGWS)			
	Up to but not including 4.5 m	4.5 m up to but not including 6 m	6 m up to but not including 9 m	9 m up to but not including 15 m
1 <sup>a</sup>	18 m	18 m	23 m	—
2 <sup>a</sup>	23 m	23 m	30 m	—
3	30 m	30 m	30 m	45 m
4	—	—	45 m	45 m

<sup>a</sup> The width of a precision approach runway should be not less than 30 m where the code number is 1 or 2.

**Table B-1. Width of runway**

- (b) The width of the runway should be measured at the outside edge of the runway side stripe marking where provided, or the edge of the runway.

[Issue: ADR-DSN/4]

## GM1 ADR-DSN.B.045 Width of runways

ED Decision 2017/021/R

- (a) The combinations of code numbers and OMGWSs for which widths are specified have been developed for typical aeroplane characteristics.
- (b) Factors affecting runway width are given in ICAO Doc 9157, Aerodrome Design Manual, Part 1, Runways.
- (c) See [CS ADR-DSN.B.125](#) to [CS ADR-DSN.B.145](#) concerning the provision of runway shoulders, in particular for code F aeroplanes with four (or more) engines.

[Issue: ADR-DSN/3]

[Issue: ADR-DSN/4]

## CS ADR-DSN.B.050 Minimum distance between parallel non-instrument runways

ED Decision 2014/013/R

- (a) Where parallel non-instrument runways are intended for simultaneous use, the minimum distance between their centre lines should be:
- (1) 210 m where the higher code number is 3 or 4;
  - (2) 150 m where the higher code number is 2; and
  - (3) 120 m where the higher code number is 1.

## GM1 ADR-DSN.B.050 Minimum distance between parallel non-instrument runways

ED Decision 2014/013/R

- (a) Except that for independent parallel approaches, combinations of minimum distances and associated conditions other than those specified in the PANS-ATM (Doc 4444) may be applied when it is determined that such combinations would not adversely affect the safety of aircraft operations.
- (b) Procedures for wake turbulence categorisation of aircraft and wake turbulence separation minima are contained in the Procedures for Air Navigation Services — Air Traffic Management (PANS-ATM), Doc 4444, Chapter 4, 4.9 and Chapter 5, 5.8, respectively.

## CS ADR-DSN.B.055 Minimum distance between parallel instrument runways

ED Decision 2016/027/R

- (a) Where parallel instrument runways are intended for simultaneous use, the minimum distance between their centre lines should be:
- (1) 1 035 m for independent parallel approaches;
  - (2) 915 m for dependent parallel approaches;
  - (3) 760 m for independent parallel departures; and
  - (4) 760 m for segregated parallel operations.
- (b) Apart from provided in (a) above, for segregated parallel operations the specified minimum distance:
- (1) may be decreased by 30 m for each 150 m that the arrival runway is staggered toward the arriving aircraft, to a minimum of 300 m; and
  - (2) should be increased by 30 m for each 150 m that the arrival runway is staggered away from the arriving aircraft.
- (c) Other combinations of minimum distances should apply taking into account ATM and operational aspects.

[Issue: ADR-DSN/3]

## GM1 ADR-DSN.B.055 Minimum distance between parallel instrument runways

*ED Decision 2016/027/R*

Guidance on procedures and facilities requirements for simultaneous operations on parallel or near-parallel instrument runways are contained in ICAO, PANS-ATM, Doc 4444, Chapter 6 and ICAO, PANS-OPS, Doc 8168, Volume I, Part III, Section 2, and Volume II, Part I, Section 3; Part II, Section 1; and Part III, Section 3, and relevant guidance is contained in ICAO Doc, 9643, Manual on Simultaneous Operations on Parallel or Near-Parallel Instrument Runways (SOIR).

[Issue: ADR-DSN/3]

## CS ADR-DSN.B.060 Longitudinal slopes of runways

*ED Decision 2016/027/R*

- (a) The safety objective of limiting the longitudinal runway slope is to enable stabilized and safe use of runway by an aircraft.
- (b) The slope computed by dividing the difference between the maximum and minimum elevation along the runway centre line by the runway length should not exceed:
  - (1) 1 % where the code number is 3 or 4; and
  - (2) 2 % where the code number is 1 or 2.
- (c) Along no portion of a runway should the longitudinal slope exceed:
  - (1) 1.25 % where the code number is 4, except that for the first and last quarter of the length of the runway where the longitudinal slope should not exceed 0.8 %;
  - (2) 1.5 % where the code number is 3, except that for the first and last quarter of the length of a precision approach runway Category II or III where the longitudinal slope should not exceed 0.8 %; and
  - (3) 2 % where the code number is 1 or 2.

[Issue: ADR-DSN/3]

## GM1 ADR-DSN.B.060 Longitudinal slopes on runways

*ED Decision 2017/021/R*

Slopes should be so designed as to minimise impact on aircraft and so not to hamper the operation of aircraft. For precision approach runways, slopes in a specified area from the runway end, and including the touchdown area, should be designed so that they should correspond to the characteristics needed for such type of approach.

[Issue: ADR-DSN/4]

## CS ADR-DSN.B.065 Longitudinal slope changes on runways

*ED Decision 2014/013/R*

- (a) The safety objective of limiting the longitudinal runway slope changes is to avoid damage of aircraft and to enable safe use of runway by an aircraft.
- (b) Where slope changes cannot be avoided, a slope change between two consecutive slopes should not exceed:

- (1) 1.5 % where the code number is 3 or 4; and
  - (2) 2 % where the code number is 1 or 2.
- (c) The transition from one slope to another should be accomplished by a curved surface with a rate of change not exceeding:
- (1) 0.1 % per 30 m (minimum radius of curvature of 30 000 m) where the code number is 4;
  - (2) 0.2 % per 30 m (minimum radius of curvature of 15 000 m) where the code number is 3; and
  - (3) 0.4 % per 30 m (minimum radius of curvature of 7 500 m) where the code number is 1 or 2.

### GM1 ADR-DSN.B.065 Longitudinal slopes changes on runways

*ED Decision 2014/013/R*

- (a) Slope changes are so designed as to reduce dynamic loads on the undercarriage system of the aeroplane. Minimising slope changes is especially important on runways where aircraft move at high speeds.
- (b) For precision approach runways, slopes in a specified area from the runway end, and including the touchdown area, are so designed that they should correspond to the characteristics needed for such type of approach.

### CS ADR-DSN.B.070 Sight distance for slopes on runways

*ED Decision 2014/013/R*

- (a) The safety objective of minimum runway sight distance values is to achieve the necessary visibility to enable safe use of runway by an aircraft.
- (b) Where slope changes on runways cannot be avoided, they should be such that there should be an unobstructed line of sight from:
  - (1) any point 3 m above a runway to all other points 3 m above the runway within a distance of at least half the length of the runway where the code letter is C, D, E, or F;
  - (2) any point 2 m above a runway to all other points 2 m above the runway within a distance of at least half the length of the runway where the code letter is B; and
  - (3) any point 1.5 m above a runway to all other points 1.5 m above the runway within a distance of at least half the length of the runway where the code letter is A.

### GM1 ADR-DSN.B.070 Sight distance for slopes of runways

*ED Decision 2016/027/R*

Runway longitudinal slopes and slopes changes are so designed that the pilot in the aircraft has an unobstructed line of sight over all or as much of the runway as possible, thereby enabling him to see aircraft or vehicles on the runway, and to be able to manoeuvre and take avoiding action.

[Issue: ADR-DSN/3]

## CS ADR-DSN.B.075 Distance between slope changes on runways

ED Decision 2014/013/R

Undulations or appreciable changes in slopes located close together along a runway should be avoided. The distance between the points of intersection of two successive curves should not be less than:

- (a) the sum of the absolute numerical values of the corresponding slope changes multiplied by the appropriate value as follows:
- (1) 30 000 m where the code number is 4;
  - (2) 15 000 m where the code number is 3; and
  - (3) 5 000 m where the code number is 1 or 2; or
- (b) 45 m;

whichever is greater.

## GM1 ADR-DSN.B.075 Distance between slope changes on runways

ED Decision 2014/013/R

The following example illustrates how the distance between slope changes is to be determined (see Figure GM-B-2):

D for a runway where the code number is 3 should be at least:

$$15\,000 (|x - y| + |y - z|) \text{ m}$$

$|x - y|$  being the absolute numerical value of  $x - y$

$|y - z|$  being the absolute numerical value of  $y - z$

Assuming  $x = +0.01$

$$y = -0.005$$

$$z = +0.005$$

then  $|x - y| = 0.015$

then  $|y - z| = 0.01$

To comply with the specifications, D should be not less than:

$$15\,000 (0.015 + 0.01) \text{ m,}$$

that is,  $15\,000 \times 0.025 = 375 \text{ m}$

When a runway is planned that should combine the extreme values for the slopes and changes in slope permitted, as prescribed in [CS ADR-DSN.B.060](#) to [CS ADR-DSN.B.080](#), a study should be made to ensure that the resulting surface profile should not hamper the operation of aeroplanes.

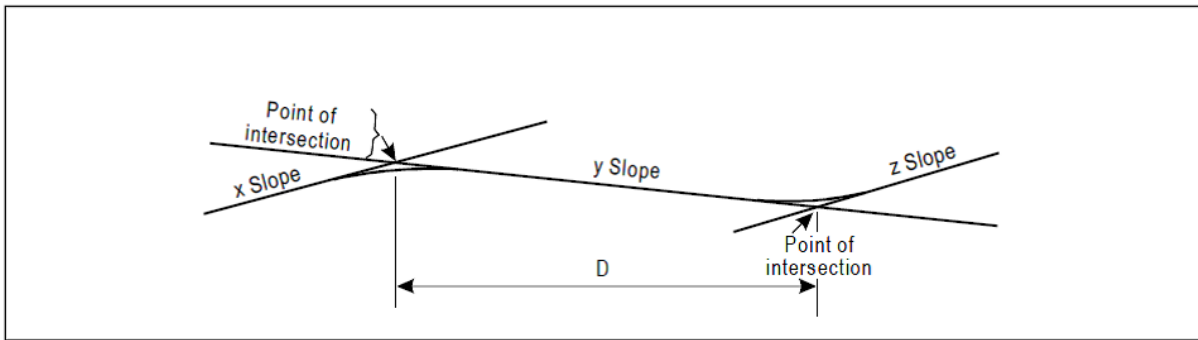


Figure GM-B-2. Profile on centre line of runway

## CS ADR-DSN.B.080 Transverse slopes on runways

ED Decision 2014/013/R

- (a) The safety objective of runway transverse slopes is to promote the most rapid drainage of water from the runway.
- (b) To promote the most rapid drainage of water, the runway surface should be cambered, except where a single crossfall from high to low in the direction of the wind most frequently associated with rain would ensure rapid drainage. The transverse slope should be:
  - (1) not less than 1 % and not more than 1.5 % where the code letter is C, D, E or F; and;
  - (2) not less than 1 % and not more than 2 % where the code letter is A or B;
 except at runway or taxiway intersections where flatter slopes may be necessary.
- (c) For a cambered surface, the transverse slope on each side of the centre line should be symmetrical.
- (d) The transverse slope should be substantially the same throughout the length of a runway except at an intersection with another runway or a taxiway where an even transition should be provided taking account of the need for adequate drainage.

## GM1 ADR-DSN.B.080 Transverse slopes on runways

ED Decision 2017/021/R

The slopes on a runway are intended to prevent the accumulation of water (or possible fluid contaminant) on the surface and to facilitate rapid drainage of surface water (or possible fluid contaminant). The water (or possible fluid contaminant) evacuation is facilitated by an adequate combination of longitudinal and transverse slopes, and may also be assisted by grooving the runway surface.

[Issue: ADR-DSN/4]

## CS ADR-DSN.B.085 Runway strength

ED Decision 2014/013/R

The runway should be of sufficient strength to support normal operations of the most demanding aircraft without risk of damage either to the aeroplane or the runway.

## GM1 ADR-DSN.B.085 Runway strength

ED Decision 2016/027/R

- (a) Pavement forming part of the movement area needs to be of sufficient strength to allow aircraft to operate without risk of damage either to the pavement or to the aircraft. Pavements subject to overload conditions should deteriorate at an increasing rate depending upon the degree of overload. To control this, it is necessary to classify both pavement and aircraft under a system whereby the load-bearing capacity of the pavement and the loads imposed by the aircraft can be compared. The method used is the Aircraft Classification Number - Pavement Classification Number (ACN/PCN) method. The ACN/PCN method has been developed by ICAO as an international method of reporting the bearing strength of pavements.
- (b) All pavements forming part of the movement area should be of adequate bearing strength for the types of aircraft expected to use the aerodrome. All pavements should be regularly examined by a suitably qualified person. Any pavements which have been subjected to overload conditions should be closely monitored by suitably qualified staff for a period of several weeks or until it is clear that no rapid deterioration of the pavement has been triggered.
- (c) Reporting pavement bearing strength:
- (1) The ACN/PCN method of classifying the bearing strength of pavements considers the load imposed on the pavement by the aircraft. In this respect, the load rating of the aircraft is most significantly affected by the subgrade support strength of the pavement. ACNs are, therefore, numbers giving a relative load rating of the aircraft on pavements for certain specified subgrade strengths. ACN values for most aeroplanes have been calculated by ICAO and are published in Aeronautical Information Publications. The PCN is also a number which represents the load-bearing strength of the pavement in terms of the highest ACN which can be accepted on the pavement for unrestricted use.
  - (2) A PCN can also be identified and reported without a technical evaluation of the pavement by means of an assessment of the results of aircraft using the pavement. Providing the type and subgrade support strength of the pavement are known, the ACN of the most demanding aircraft successfully using the pavement can be reported as the PCN.
  - (3) A PCN is reported in a five-part format. Apart from the numerical value, notification is also required of the pavement type (rigid or flexible) and the subgrade support category. Additionally, provision is made for the aerodrome operator to limit the maximum allowable tire pressure. A final indication is whether the assessment has been made by a technical evaluation or from past experience of aircraft using the pavement.

[Issue: ADR-DSN/3]

## CS ADR-DSN.B.090 Surface of runways

ED Decision 2016/027/R

- (a) The surface of a runway should be constructed without irregularities that would impair the runway surface friction characteristics or otherwise adversely affect the take-off or landing of an aeroplane.
- (b) A paved runway should be so constructed or resurfaced as to provide surface friction characteristics at or above the minimum friction level.
- (c) The average surface texture depth of a new surface should be not less than 1.0 mm.
- (d) When the surface is grooved or scored, the grooves or scorings should be either perpendicular to the runway centre line or parallel to non-perpendicular transverse joints where applicable.

[Issue: ADR-DSN/3]

## GM1 ADR-DSN.B.090 Surface of runways

*ED Decision 2016/027/R*

- (a) In adopting tolerances for runway surface irregularities, the following standard of construction is achievable for short distances of 3 m and conform to good engineering practice: except across the crown of a camber or across drainage channels, the finished surface of the wearing course is to be of such regularity that when tested with a 3 m straight-edge placed anywhere in any direction on the surface, there is no deviation greater than 3 mm between the bottom of the straight-edge and the surface of the pavement anywhere along the straight-edge.
- (b) Caution should also be exercised when inserting runway lights or drainage grilles in runway surfaces to ensure that adequate smoothness of the surface is maintained.
- (c) Additional guidance on surface of runways is given in ICAO Doc 9157, Aerodrome Design Manual, Part 3, Pavements.
- (d) Macrottexture and microtexture should be taken into consideration in order to provide the required surface friction characteristics. Additional guidance is given in [GM1 ADR-DSN.B.191](#). Additional guidance on design and methods for improving runway surface texture is given in ICAO Doc 9157, Aerodrome Design Manual, Part 3, Pavements.
- (e) The surface of a paved runway should be evaluated when constructed or resurfaced to determine that the surface friction characteristics achieve the design objectives.

[Issue: ADR-DSN/3]

## CS ADR-DSN.B.095 Runway turn pads

*ED Decision 2017/021/R*

- (a) The safety objective of the runway turn pad is to facilitate a safe 180-degree turn by aeroplanes on runway ends that are not served by a taxiway or taxiway turnaround.
- (b) Where the end of a runway is not served by a taxiway or a taxiway turnaround, and if required, a runway turn pad should be provided to facilitate a 180-degree turn of aeroplanes.
- (c) The design of a runway turn pad should be such that when the cockpit of the most demanding aircraft for which the turn pad is intended remains over the turn pad marking, the clearance distance between any wheel of the aeroplane landing gear and the edge of the turn pad should be not less than that given by the following tabulation:

	Outer Main Gear Wheel Span (OMGWS)			
	Up to but not including 4.5 m	4.5 m up to but not including 6 m	6 m up to but not including 9 m	9 m up to but not including 15 m
Clearance	1.50 m	2.25 m	3 m <sup>a</sup> or 4 m <sup>b</sup>	4 m

<sup>a</sup> if the turn pad is intended to be used by aeroplanes with a wheel base less than 18 m.

<sup>b</sup> if the turn pad is intended to be used by aeroplanes with a wheel base equal to or greater than 18 m.

Note: Wheel base means the distance from the nose gear to the geometric centre of the main gear.

- (d) The runway turn pad should be located on either the left or right side of the runway and adjoining the runway pavement at both ends of the runway and at some intermediate locations where deemed necessary.
- (e) The intersection angle of the runway turn pad with the runway should not exceed 30 degrees.



- (f) The nose wheel steering angle to be used in the design of the runway turn pad should not exceed 45 degrees.

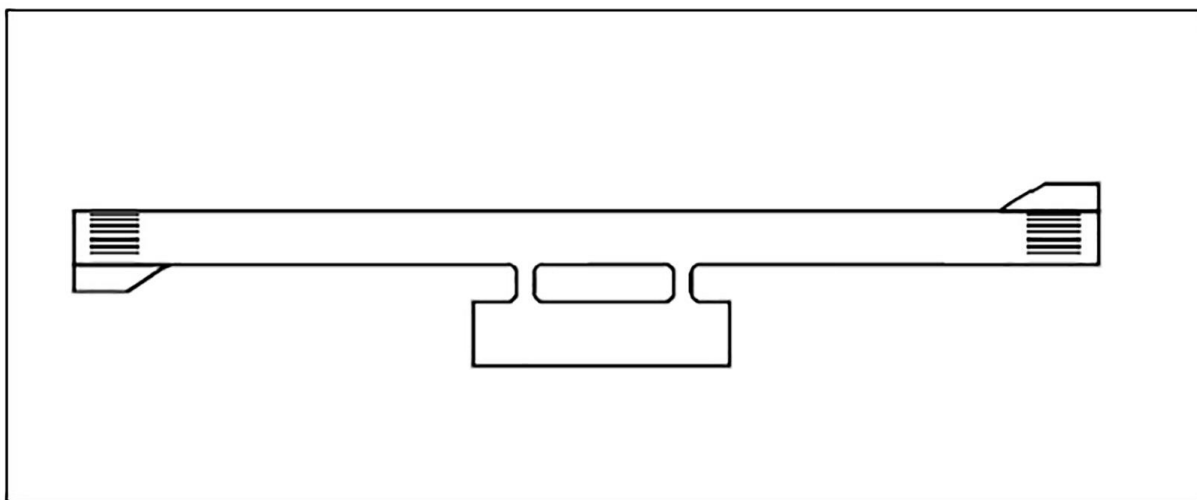
[Issue: ADR-DSN/4]

## GM1 ADR-DSN.B.095 Runway turn pads

*ED Decision 2017/021/R*

Where severe weather conditions and resultant lowering of surface friction characteristics prevail, a larger wheel-to-edge clearance should be provided.

- (a) A typical runway turn pad layout is presented in Figure GM-B-3 below:



**Figure GM-B-3. Typical turn pad layout**

- (b) Additional guidance on the design of runway turn pads is given in ICAO Doc 9157, Aerodrome Design Manual, Part 1, Runways.

[Issue: ADR-DSN/3]

[Issue: ADR-DSN/4]

## CS ADR-DSN.B.100 Slopes on runway turn pads

*ED Decision 2014/013/R*

The longitudinal and transverse slopes on a runway turn pad should be sufficient to prevent the accumulation of water on the surface and facilitate rapid drainage of surface water. The slopes should be the same as those on the adjacent runway pavement surface.

## GM1 ADR-DSN.B.100 Slopes on runway turn pads

*ED Decision 2014/013/R*

Slopes should be so designed as to minimise impact on aircraft and so not to hamper the operation of aircraft.

## CS ADR-DSN.B.105 Strength of runway turn pads

*ED Decision 2014/013/R*

The strength of a runway turn pad should be compatible with the adjoining runway which it serves, due consideration being given to the fact that the turn pad should be subjected to slow-moving traffic making hard turns and consequent higher stresses on the pavement.

## GM1 ADR-DSN.B.105 Strength of runway turn pads

ED Decision 2014/013/R

intentionally left blank

## CS ADR-DSN.B.110 Surface of runway turn pads

ED Decision 2016/027/R

- (a) The surface of a runway turn pad should not have surface irregularities that may cause damage to an aeroplane using the turn pad.
- (b) The surface of a runway turn pad should be so constructed or resurfaced as to provide surface friction characteristics at least equal to that of the adjoining runway.

[Issue: ADR-DSN/3]

## GM1 ADR-DSN.B.110 Surface of runway turn pads

ED Decision 2014/013/R

intentionally left blank

## CS ADR-DSN.B.115 Width of shoulders for runway turn pads

ED Decision 2014/013/R

The runway turn pads should be provided with shoulders of such width as is necessary to prevent surface erosion by the jet blast of the most demanding aircraft for which the turn pad is intended and any possible foreign object damage to the aeroplane engines.

## GM1 ADR-DSN.B.115 Width of shoulders for runway turn pads

ED Decision 2014/013/R

As a minimum, the width of the shoulders would need to cover the outer engine of the most demanding aircraft and thus may be wider than the associated runway shoulders.

## CS ADR-DSN.B.120 Strength of shoulders for runway turn pads

ED Decision 2014/013/R

The strength of runway turn pad shoulders should be capable of withstanding the occasional passage of the most demanding aircraft it is designed to serve without inducing structural damage to the aircraft and to the supporting ground vehicles that may operate on the shoulder.

## GM1 ADR-DSN.B.120 Strength of shoulders for runway turn pads

ED Decision 2014/013/R

intentionally left blank

## CS ADR-DSN.B.125 Runway shoulders

ED Decision 2017/021/R

- (a) The safety objective of runway shoulder is that it should be so constructed as to mitigate any hazard to an aircraft running off the runway or stopway or to avoid the ingestion of loose stones or other objects by turbine engines.

- (b) Runway shoulders should be provided for a runway where the code letter is D, E or F, for aeroplanes with an OMGWS from 9 m up to but not including 15 m.

[Issue: ADR-DSN/4]

## GM1 ADR-DSN.B.125 Runway shoulders

*ED Decision 2017/021/R*

- (a) Runway shoulders should be considered because strong crosswinds may result in significant deviation from the runway centre line. In the case of some large aircraft, the wing-mounted engines may overhang the runway edge and there is a risk of jet blast eroding the surface adjacent to the runway. This can cause dust and the possible ingestion of debris by the engines.
- (b) Further guidance on runway shoulders is given in ICAO Doc 9157, Aerodrome Design Manual, Part 1, Runways.
- (c) Mitigation measures that can be considered are to provide the runway with inset runway edge lights (in lieu of elevated lights, to protect aeroplane from ingestion) and additional runway centre line guidance.

[Issue: ADR-DSN/3]

[Issue: ADR-DSN/4]

## CS ADR-DSN.B.130 Slopes on runway shoulders

*ED Decision 2014/013/R*

- (a) The safety objective of runway shoulder transverse slopes is to promote the most rapid drainage of water from the runway and runway shoulder.
- (b) The surface of the paved shoulder that abuts the runway should be flush with the surface of the runway and its transverse slope should not exceed 2.5 %.

## GM1 ADR-DSN.B.130 Slopes on runway shoulders

*ED Decision 2014/013/R*

intentionally left blank

## CS ADR-DSN.B.135 Width of runway shoulders

*ED Decision 2017/021/R*

For aeroplanes with an OMGWS from 9 m up to but not including 15 m the runway shoulders should extend symmetrically on each side of the runway so that the overall width of the runway and its shoulders is not less than:

- (a) 60 m where the code letter is D or E;
- (b) 60 m where the code letter is F with two- or three-engined aeroplanes; and
- (c) 75 m where the code letter is F with four (or more) engined aeroplanes.

[Issue: ADR-DSN/3]

[Issue: ADR-DSN/4]

## GM1 ADR-DSN.B.135 Width of runway shoulders

ED Decision 2014/013/R

intentionally left blank

## CS ADR-DSN.B.140 Strength of runway shoulders

ED Decision 2017/021/R

The portion of a runway shoulder between the runway edge and a distance of 30 m from the runway centre line should be prepared or constructed so as to be capable, in the event of an aeroplane running off the runway, of supporting the aeroplane without inducing structural damage to the aeroplane and of supporting ground vehicles which may operate on the shoulder.

[Issue: ADR-DSN/4]

## GM1 ADR-DSN.B.140 Strength of runway shoulders

ED Decision 2017/021/R

- (a) Runway shoulders should be so prepared as to be capable of supporting the aeroplanes using the runway without causing structural damage to those aeroplanes. They should also be capable of supporting vehicles such as firefighting appliances. In some cases, whilst the bearing strength of the natural ground may be sufficient, special preparation may be necessary to avoid erosion and the possible ingestion of debris by engines.
- (b) Guidance on characteristics and treatment of runway shoulders:
  - (1) The shoulder of a runway or stopway should be prepared or constructed so as to support an aeroplane and minimise any hazard to an aeroplane running off the runway or stopway. Some guidance is given in the following paragraphs on certain special problems which may arise, and on further measures to avoid the ingestion of loose stones or other objects by turbine engines.
  - (2) In some cases, the bearing strength of the natural ground in the strip may be sufficient, without special preparation, to meet the requirements for shoulders. Where special preparation is necessary, the method used should depend on local soil conditions and on the mass of the aeroplanes the runway is intended to serve. Soil tests should help in determining the best method of improvement (e.g. drainage, stabilisation, surfacing and light paving).
- (c) Attention should also be paid when designing shoulders to prevent the ingestion of stones or other objects by turbine engines. Similar considerations apply here to those discussed for the margins of taxiways both as to the special measures that may be necessary and as to the distance over which such special measures, if required, should be taken. Further guidance is given in ICAO Doc 9157, Aerodrome Design Manual, Part 1 Runways, and Part 2, Taxiways, Aprons and Holding Bays.
- (d) Where shoulders have been treated specially, either to provide the required bearing strength or to prevent the presence of stones or debris, difficulties may arise because of a lack of visual contrast between the runway surface and that of the adjacent strip. Such difficulties can be overcome either by providing a good visual contrast between the surfacing of the runway and of the strip, or by providing a runway side stripe marking.
- (e) Additional guidance on strength of runway shoulders is given in ICAO Doc 9157, Aerodrome Design Manual, Part 1, Runways.

[Issue: ADR-DSN/3]

[Issue: ADR-DSN/4]

## CS ADR-DSN.B.145 Surface of runway shoulders

ED Decision 2017/021/R

- (a) The surface of a runway shoulder should be prepared or constructed so as to resist erosion and prevent the ingestion of the surface material by aeroplane engines.
- (b) Runway shoulders for code letter F aeroplanes should be paved to a minimum overall width of runway and shoulder of not less than 60 m.

[Issue: ADR-DSN/4]

## GM1 ADR-DSN.B.145 Surface of runway shoulders

ED Decision 2017/021/R

- (a) Where a runway shoulder is not paved, additional surface treatment or inspections may be necessary, especially for runways that accept operations by 4-engined aircraft with a code letter D or larger.
- (b) Shoulders for runways where the code letter is E normally should be paved.
- (c) If movements of 4-engined aircraft with a code letter D take place, the need for fully paved width shoulders should be assessed by local hazard analysis. Where the runway shoulder is not paved, it may be possible to contain the risk from erosion or from the ingestion of debris. In such cases:
  - (1) The runway shoulder should be stabilised and the ground is prepared so that there is full grass coverage with no loose gravel or other material. This may include additional materials if the bearing strength and surface of the ground are not sufficient.
  - (2) A programme of inspections of the shoulders and runway may be implemented to confirm their continuing serviceability, and ensure that there is no deterioration that could create a risk of foreign object debris (FOD), or otherwise hazard aircraft operations.
  - (3) A programme of sweeping may be required before and after movements, should debris be drawn onto the runway surface.
- (d) Additional guidance on surface of runway shoulders is given in ICAO Doc 9157, Aerodrome Design Manual, Part 1, Runways.

[Issue: ADR-DSN/4]

## CS ADR-DSN.B.150 Runway strip to be provided

ED Decision 2017/021/R

- (a) The safety objective of the runway strip is to reduce the risk of damage to an aircraft accidentally running off the runway, to protect aircraft flying over it when taking-off or landing, and to enable safe use by rescue and firefighting (RFF) vehicles.
- (b) A runway and any associated stopways should be included in a strip.

[Issue: ADR-DSN/4]

## GM1 ADR-DSN.B.150 Runway strip to be provided

*ED Decision 2017/021/R*

- (a) A runway strip extends laterally to a specified distance from the runway centre line, longitudinally before the threshold, and beyond the runway end. It provides an area clear of objects that may endanger aeroplanes. Any equipment or installation required for air navigation or for aircraft safety purposes and is located in this object-free area should be frangible and mounted as low as possible.
- (b) When the threshold or end of the landing distance do not coincide with the ends of a runway, the runway strip enclosing the runway and any associated stopway should extend to the lengths specified in [CS ADR-DSN.B.155](#) at the widths specified in [CS ADR-DSN.B.160](#), based on the threshold, end of landing distance or end of stopway, as appropriate.

[Issue: ADR-DSN/4]

## CS ADR-DSN.B.155 Length of runway strip

*ED Decision 2016/027/R*

- (a) A strip should extend before the threshold and beyond the end of the runway or stopway for a distance of at least:
  - (1) 60 m where the code number is 2, 3, or 4;
  - (2) 60 m where the code number is 1 and the runway is an instrument one; and
  - (3) 30 m where the code number is 1 and the runway is a non-instrument one.

[Issue: ADR-DSN/3]

## GM1 ADR-DSN.B.155 Length of runway strip

*ED Decision 2014/013/R*

intentionally left blank

## CS ADR-DSN.B.160 Width of runway strip

*ED Decision 2017/021/R*

- (a) A strip including a precision approach runway should extend laterally to a distance of at least:
  - (1) 140 m where the code number is 3 or 4; and
  - (2) 70 m where the code number is 1 or 2;on each side of the centre line of the runway and its extended centre line throughout the length of the strip.
- (b) A strip including a non-precision approach runway should extend laterally to a distance of at least:
  - (1) 140 m where the code number is 3 or 4; and
  - (2) 70 m where the code number is 1 or 2;on each side of the centre line of the runway and its extended centre line throughout the length of the strip.
- (c) A strip including a non-instrument runway should extend on each side of the centre line of the runway and its extended centre line throughout the length of the strip, to a distance of at least:

- (1) 75 m where the code number is 3 or 4;
- (2) 40 m where the code number is 2; and
- (3) 30 m where the code number is 1.

[Issue: ADR-DSN/4]

## GM1 ADR-DSN.B.160 Width of runway strip

*ED Decision 2014/013/R*

intentionally left blank

## CS ADR-DSN.B.165 Objects on runway strips

*ED Decision 2021/004/R*

- (a) An object situated on a runway strip which may endanger aeroplanes should be regarded as an obstacle and should, as far as practicable, be removed.
- (b) No fixed object, other than visual aids required for air navigation or those required for aircraft safety purposes and which must be sited on the runway strip, and satisfying the relevant frangibility requirement in Chapter T, should be permitted on a runway strip:
  - (1) within 77.5 m of the runway centre line of a precision approach runway Category I, II or III where the code number is 4 and the code letter is F; or
  - (2) within 60 m of the runway centre line of a precision approach runway Category I, II or III where the code number is 3 or 4; or
  - (3) within 45 m of the runway centre line of a precision approach runway Category I where the code number is 1 or 2.
- (c) To eliminate a buried vertical surface on objects situated on a graded portion of the runway strip, a slope should be provided to minimise hazards to aeroplanes running off the runway.

[Issue: ADR-DSN/3]

[Issue: ADR-DSN/5]

## GM1 ADR-DSN.B.165 Objects on runway strips

*ED Decision 2017/021/R*

- (a) Within the graded portion of the runway strip, measures should be taken to prevent an aeroplane's wheel when sinking into the ground, from striking a hard vertical face. Special problems may arise for runway light fittings or other objects mounted in the strip or at the intersection with a taxiway or another runway. In the case of constructions within the graded portion of the runway strip, such as intersecting runways or taxiways, where the surface should also be flush with the strip surface, they should be dealthalised, that is, so constructed as to avoid presenting a buried vertical face to aircraft wheels in soft ground conditions in any direction from which an aircraft is likely to approach. A vertical face can be eliminated by chamfering from the top of those constructions to not less than 30 cm below the strip surface level. Other objects situated within the graded portion of the runway strip, the functions of which do not require them to be at surface level, should be buried to a depth of not less than 30 cm. Where this is not feasible, to eliminate a buried vertical surface, a slope should be provided which extends from the top of the construction to not less than 30 cm below ground level. The slope can be created by using a mixture of compacted gravel or asphalt or crushed aggregates and soil.

- (b) Consideration should be given to the location and design of drains on a runway strip to prevent damage to an aeroplane accidentally running off a runway. Suitably designed drain covers may be required.
- (c) Guidance on the design of drain covers is given in ICAO Doc 9157, Aerodrome Design Manual, Part 1, Runways.
- (d) Where open-air or covered storm water conveyances are installed, consideration should be given in order to ensure that their structure does not extend above the surrounding ground so as not to be considered an obstacle.
- (e) Particular attention needs to be given to the design and maintenance of an open-air storm water conveyance in order to prevent wildlife attraction, in particular birds. The open-air storm water conveyance may be covered by a net, if required. Further guidance is given in ICAO Doc 9137, Airport Services Manual, Part 3, Wildlife Control and Reduction.

[Issue: ADR-DSN/3]

[Issue: ADR-DSN/4]

## CS ADR-DSN.B.170

*ED Decision 2014/013/R*

intentionally left blank

## GM1 ADR-DSN.B.170

*ED Decision 2014/013/R*

intentionally left blank

## CS ADR-DSN.B.175 Grading of runway strips

*ED Decision 2017/021/R*

- (a) That portion of a strip of an instrument runway within a distance of at least:
  - (1) 75 m where the code number is 3 or 4; and
  - (2) 40 m where the code number is 1 or 2;from the centre line of the runway and its extended centre line should provide a graded area for aeroplanes which the runway is intended to serve in the event of an aeroplane running off the runway.
- (b) That portion of a strip of a non-instrument runway within a distance of at least:
  - (1) 75 m where the code number is 3 or 4;
  - (2) 40 m where the code number is 2; and
  - (3) 30 m where the code number is 1;from the centre line of the runway and its extended centre line should provide a graded area for aeroplanes which the runway is intended to serve in the event of an aeroplane running off the runway.
- (c) The surface of that portion of a strip that abuts a runway, shoulder, or stopway should be flush with the surface of the runway, shoulder, or stopway.



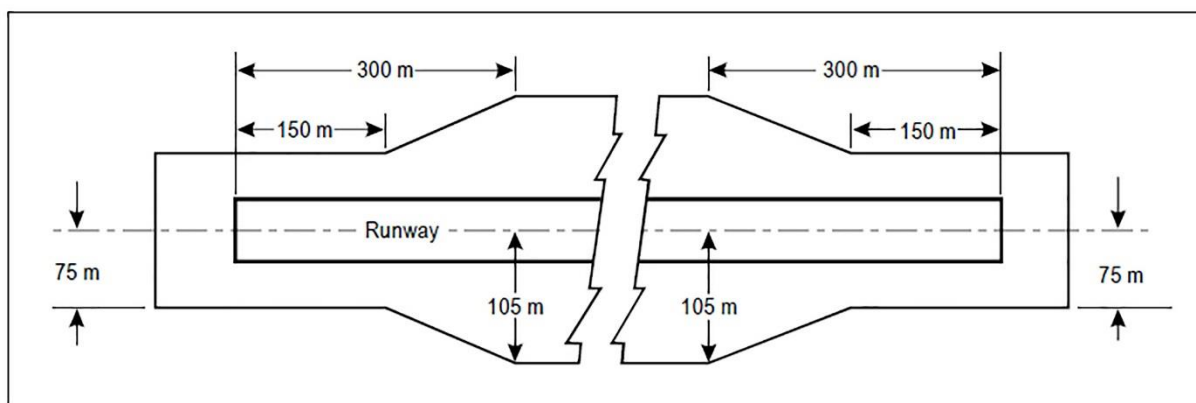
- (d) That portion of a strip to at least 30 m before the start of a runway should be prepared against blast erosion in order to protect a landing aeroplane from the danger of an exposed edge.

[Issue: ADR-DSN/4]

## GM1 ADR-DSN.B.175 Grading of runway strips

ED Decision 2017/021/R

- (a) For a precision approach runway, where the code number is 3 or 4, it may be desirable a greater width of that portion of a strip to be graded should be considered. Figure GM-B-4 shows the shape and dimensions of a wider strip that may be considered for such a runway. This strip has been designed using information on aircraft running off runways. The portion to be graded extends to a distance of 105 m from the centre line, except that the distance is gradually reduced to 75 m from the centre line at both ends of the strip, for a length of 150 m from the runway end.



**Figure GM-B-4. Graded portion of a strip including a precision approach runway where the code number is 3 or 4**

- (b) Where the areas in paragraph (a) above have paved surface, they should be able to withstand the occasional passage of the critical aeroplane for runway pavement design.
- (c) The area adjacent to the end of a runway may be referred to as a blast pad.
- (d) Additional guidance on grading is given in ICAO Doc 9157, Aerodrome Design Manual Part 1, Runways.
- (e) The area provided to reduce the erosive effects of jet blast and propeller wash may be referred to as a blast pad.
- (f) Guidance on protection against aeroplane engine blast is given in ICAO Doc 9157, Aerodrome Design Manual, Part 2.

[Issue: ADR-DSN/3]

[Issue: ADR-DSN/4]

## CS ADR-DSN.B.180 Longitudinal slopes on runway strips

ED Decision 2014/013/R

- (a) The safety objective of longitudinal runway strip slope is to define maximum gradient values that should not interfere with the safe use of the runway strip by an aircraft.
- (b) A longitudinal slope along that portion of a strip to be graded should not exceed:
- (1) 1.5 % where the code number is 4;

- (2) 1.75 % where the code number is 3; and
  - (3) 2 % where the code number is 1 or 2.
- (c) Longitudinal slope changes on that portion of a strip to be graded should be as gradual as practicable, and abrupt changes or sudden reversals of slopes should be avoided.

## GM1 ADR-DSN.B.180 Longitudinal Slopes on runway strips

*ED Decision 2014/013/R*

intentionally left blank

## CS ADR-DSN.B.185 Transverse slopes on runway strips

*ED Decision 2014/013/R*

- (a) Transverse slopes on that portion of a strip to be graded should be adequate to prevent the accumulation of water on the surface but should not exceed:
- (1) 2.5 % where the code number is 3 or 4; and
  - (2) 3 % where the code number is 1 or 2;
- except that to facilitate drainage from the slope for the first 3 m outward from the runway, shoulder or stopway edge should be negative as measured in the direction away from the runway and may be as great as 5 %.
- (b) The transverse slopes of any portion of a strip beyond that to be graded should not exceed an upward slope of 5 % as measured in the direction away from the runway.

## GM1 ADR-DSN.B.185 Transverse slopes on runway strips

*ED Decision 2017/021/R*

- (a) Where required for proper drainage, an open-air storm water conveyance may be allowed in the non-graded portion of a runway strip and should be placed as far as practicable from the runway.
- (b) The aerodrome RFF procedure should take into account the location of open-air storm water conveyances within the non-graded portion of a runway strip.

[Issue: ADR-DSN/4]

## CS ADR-DSN.B.190 Strength of runway strips

*ED Decision 2014/013/R*

- (a) That portion of a strip of an instrument runway within a distance of at least:
- (1) 75 m where the code number is 3 or 4; and
  - (2) 40 m where the code number is 1 or 2;
- from the centre line of the runway and its extended centre line should be prepared or constructed so as to minimise hazards arising from differences in load-bearing capacity to aeroplanes which the runway is intended to serve in the event of an aeroplane running off the runway.
- (b) That portion of a strip containing a non-instrument runway within a distance of at least:
- (1) 75 m where the code number is 3 or 4;

- (2) 40 m where the code number is 2; and
- (3) 30 m where the code number is 1;

from the centre line of the runway and its extended centre line should be prepared or constructed so as to minimise hazards arising from differences in load-bearing capacity to aeroplanes which the runway is intended to serve in the event of an aeroplane running off the runway.

## GM1 ADR-DSN.B.190 Strength of runway strips

ED Decision 2016/027/R

Since the graded portion of a strip is provided to minimise the hazard to an aircraft running off the runway, it should grant sufficient strength in such a manner as to prevent the collapse of the nose landing gear of the aircraft. The surface should be prepared in such a manner as to provide drag to an aircraft and below the surface, it should have sufficient bearing strength to avoid damage to the aircraft. To meet these divergent needs, the following guidelines are provided for preparing the strip. It is noted, that a depth of 15 cm is a depth to which the nose gear may sink without collapsing. Therefore, it is recommended that the soil at a depth of 15 cm below the finished strip surface should be prepared to have a sufficient stability, demonstrated by bearing strength of California Bearing Ratio (CBR) value of 15 to 20. The intention of this is to prevent the nose gear from damage. The top 15 cm may be of lesser strength which would facilitate deceleration of aircraft. There are also other methods for soil investigation. In case of a deeper sinking than 15 cm, the maximum wheel sinking without collapsing should be examined by using different methods of soil investigation.

[Issue: ADR-DSN/3]

## CS ADR-DSN.B.191 Drainage characteristics of the movement area and adjacent areas

ED Decision 2016/027/R

The safety objective of the drainage systems of the movement area and adjacent areas is to minimise water depth on the surface by draining surface water off the runway in the shortest path practicable and particularly out of the area of the wheel path.

[Issue: ADR-DSN/3]

## GM1 ADR-DSN.B.191 Drainage characteristics of the movement area and adjacent areas

ED Decision 2016/027/R

- (a) Rapid drainage of surface water is a primary safety consideration in the design, construction and maintenance of movement area and adjacent areas.
- (b) There are two distinct drainage processes:
  - (1) natural drainage of the surface water from the top of the pavement surface until it reaches the final recipient such as rivers or other water bodies; and
  - (2) dynamic drainage of the surface water trapped under a moving tire until it reaches outside the tire-to-ground contact area.

Both drainage processes can be controlled through design, construction and maintenance of the pavements in order to prevent accumulation of water on the pavement surface.

- (c) Surface drainage is a basic requirement and serves to minimise water depth on the surface. Adequate surface drainage is provided primarily by an appropriately sloped surface (in both the longitudinal and transverse directions). The resulting combined longitudinal and transverse slope is the path for the drainage runoff. This path can be shortened by adding transverse grooves.
- (d) Dynamic drainage is achieved through built-in texture in the pavement surface. The rolling tire builds up water pressure and squeezes the water out the escape channels provided by the texture. The dynamic drainage of the tire-to-ground contact area may be improved by adding transverse grooves provided that they are subject to rigorous maintenance.
- (e) Through construction, the drainage characteristics of the surface are built into the pavement. These surface characteristics are:
  - (1) Slopes;
  - (2) Texture:
    - (i) Microtexture;
    - (ii) Macrottexture.
- (f) Slopes for the various parts of the movement area and adjacent parts are described in Chapters B to G and figures are given as per cent. Further guidance is given in ICAO Doc 9157, Aerodrome Design Manual, Part 1, Runways, Chapter 5.
- (g) Texture in the literature is described as microtexture or macrottexture. These terms are understood differently in various part of the aviation industry.
- (h) Microtexture is the texture of the individual stones and is hardly detectable by the eye. Microtexture is considered a primary component in skid resistance at slow speeds. On a wet surface at higher speeds a water film may prevent direct contact between the surface asperities and the tire due to insufficient drainage from the tire-to-ground contact area. Microtexture is a built-in quality of the pavement surface. By specifying crushed material that will withstand polishing microtexture, drainage of thin water films are ensured for a longer period of time. Resistance against polishing is expressed in terms of the polished stone values (PSV) which is in principle a value obtained from a friction measurement in accordance with international standards. These standards define the PSV minima that will enable a material with a good microtexture to be selected. A major problem with microtexture is that it can change within short time periods without being easily detected. A typical example of this is the accumulation of rubber deposits in the touchdown area which will largely mask microtexture without necessarily reducing macrottexture.
- (k) Macrottexture is the texture among the individual stones. This scale of texture may be judged approximately by the eye. Macrottexture is primarily created by the size of aggregate used or by surface treatment of the pavement and is the major factor influencing drainage capacity at high speeds. Materials should be selected so as to achieve good macrottexture.
- (l) The primary purpose of grooving a runway surface is to enhance surface drainage. Natural drainage can be slowed down by surface texture, but grooving can speed up the drainage by providing a shorter drainage path and increasing the drainage rate.
- (m) For measurement of macrottexture, simple methods such as the 'sand and grease patch' methods described in ICAO Doc 9137, Airport Services Manual, Part 2, Pavement Surface Conditions were developed. These methods were used for the early research on which current airworthiness requirements are based and which refer to a classification categorising

macrotexture from A to E. This classification was developed, using sand or grease patch measuring techniques, and issued in 1971 by the Engineering Sciences Data Unit (ESDU).

Runway classification based on texture information from ESDU 71026:	
Classification	Texture depths (mm)
A	0.10 – 0.14
B	0.15 – 0.24
C	0.25 – 0.50
D	0.51 – 1.00
E	1.01 – 2.54

- (n) Using this classification, the threshold value between microtexture and macrotexture is 0.1 mm mean texture depth (MTD). Related to this scale, the normal wet runway aircraft performance is based upon texture giving drainage and friction qualities midway between classification B and C (0.25 mm). Improved drainage through better texture might qualify for a better aircraft performance class. However, such credit must be in accordance with aeroplane manufacturers' documentation. Presently credit is given to grooved or porous friction course runways following design, construction and maintenance criteria. The harmonised certification standards of some States refer to texture giving drainage and friction qualities midway between classification D and E (1.0 mm).
- (o) For construction, design and maintenance, various international standards are used. Currently ISO 13473-1: 'Characterization of pavement texture by use of surface profiles — Part 1: Determination of Mean Profile Depth' links the volumetric measuring technique with non-contact profile measuring techniques giving comparable texture values. These standards describe the threshold value between microtexture and macrotexture as 0.5 mm. The volumetric method has a validity range from 0.25 to 5 mm MTD. The profilometry method has a validity range from 0 to 5 mm mean profile depth (MPD). The values of MPD and MTD differ due to the finite size of the glass spheres used in the volumetric technique and because the MPD is derived from a two-dimensional profile rather than a three-dimensional surface. Therefore, a transformation equation must be established for the measuring equipment used to relate MPD to MTD.
- (p) The ESDU scale groups runway surfaces based on macrotexture from A through E, where E represents the surface with best dynamic drainage capacity. The ESDU scale thus reflects the dynamic drainage characteristics of the pavement. Grooving any of these surfaces enhances the dynamic drainage capacity. The resulting drainage capacity of the surface is thus a function of the texture (A through E) and grooving. The contribution from grooving is a function of the size of the grooves and the spacing between the grooves. Aerodromes exposed to heavy or torrential rainfall must ensure that the pavement and adjacent areas have drainage capability to withstand these rainfalls or put limitations on the use of the pavements under such extreme situations. These airports should seek to have the maximum allowable slopes and the use of aggregates providing good drainage characteristics. They should also consider grooved pavements in the E classification to ensure that safety is not impaired.

[Issue: ADR-DSN/3]

## CS ADR-DSN.B.195 Clearways

*ED Decision 2016/027/R*

- (a) The inclusion of detailed specifications for clearways below is not intended to imply that a clearway has to be provided.

- (b) Location of clearways: The origin of a clearway should be at the end of the take-off run available.
- (c) Length of clearways: The length of a clearway should not exceed half the length of the take-off run available.
- (d) Width of clearways: A clearway should extend laterally to a distance of at least 75 m on each side of the extended centre line of the runway.
- (e) Slopes on clearways: The ground in a clearway should not project above a plane having an upward slope of 1.25 %, the lower limit of this plane being a horizontal line which:
  - (1) is perpendicular to the vertical plane containing the runway centre line; and
  - (2) passes through a point located on the runway centre line at the end of the take-off run available.
- (f) An object situated on a clearway which may endanger aeroplanes in the air should be regarded as an obstacle and should be removed.

[Issue: ADR-DSN/3]

## GM1 ADR-DSN.B.195 Clearways

*ED Decision 2014/013/R*

- (a) Because of transverse or longitudinal slopes on a runway, shoulder, or strip, in certain cases, the lower limit of the clearway plane specified above may be below the corresponding elevation of the runway, shoulder, or strip. It is not intended that these surfaces be graded to conform with the lower limit of the clearway plane, nor is it intended that terrain or objects which are above the clearway plane beyond the end of the strip, but below the level of the strip be removed unless it is considered that they may endanger aeroplanes.
- (b) Abrupt upward changes in slope should be avoided when the slope on the ground in a clearway is relatively small or when the mean slope is upward. In such situations, in that portion of the clearway within a distance of 22.5 m or half the runway width whichever is greater, on each side of the extended centre line, the slopes, slope changes, and the transition from runway to clearway should generally conform with those of the runway with which the clearway is associated.
- (c) The decision to provide a stopway and/or a clearway as an alternative to an increased length of runway should depend on the physical characteristics of the area beyond the runway end, and on the operating performance requirements of the prospective aeroplanes. The runway, stopway, and clearway lengths to be provided are determined by the aeroplane take-off performance but a check should also be made of the landing distance required by the aeroplanes using the runway to ensure that adequate runway length is provided for landing. The length of a clearway, however, cannot exceed half the length of take-off run available.
- (d) The aeroplane performance operating limitations require a length which is enough to ensure that the aeroplane can, after starting a take-off, either be brought safely to a stop or complete the take-off safely. For the purpose of discussion, it is supposed that the runway, stopway and clearway lengths provided at the aerodrome are only just adequate for the aeroplane requiring the longest take-off and accelerate-stop distances, taking into account its take-off mass, runway characteristics, and ambient atmospheric conditions. Under these circumstances there is, for each take-off, a speed, called the decision speed; below this speed, the take-off should be abandoned if an engine fails while above it the take-off should be completed. A very long take-off run and take-off distance would be required to complete a take-off when an engine fails before the decision speed is reached because of the insufficient speed and the reduced power

available. There would be no difficulty in stopping in the remaining accelerate-stop distance available provided action is taken immediately. In these circumstances the correct course of action would be to abandon the take-off.

- (e) On the other hand if an engine fails after the decision speed is reached, the aeroplane should have sufficient speed and power available to complete the take-off safely in the remaining take-off distance available. However, because of the high speed, there would be difficulty in stopping the aeroplane in the remaining accelerate-stop distance available.
- (f) The decision speed is not a fixed speed for any aeroplane but can be selected by the pilot within limits to suit the accelerate-stop and take-off distance available, aeroplane take-off mass, runway characteristics, and ambient atmospheric conditions at the aerodrome. Normally, a higher decision speed is selected as the accelerate-stop distance available increases.
- (g) A variety of combinations of accelerate-stop distances required and take-off distances required can be obtained to accommodate a particular aeroplane, taking into account the aeroplane take-off mass, runway characteristics, and ambient atmospheric conditions. Each combination requires its particular length of take-off run.
- (h) The most familiar case is where the decision speed is such that the take-off distance required is equal to the accelerate-stop distance required; this value is known as the balanced field length. Where stopway and clearway are not provided, these distances are both equal to the runway length. However, if landing distance is for the moment ignored, runway is not essential for the whole of the balanced field length, as the take-off run required is, of course, less than the balanced field length. The balanced field length can, therefore, be provided by a runway supplemented by an equal length of clearway and stopway, instead of wholly as a runway. If the runway is used for take-off in both directions, an equal length of clearway and stopway has to be provided at each runway end. The saving in runway length is, therefore, bought at the cost of a greater overall length.
- (i) In case economic considerations preclude the provision of stopway and, as a result, only runway and clearway are to be provided, the runway length (neglecting landing requirements) should be equal to the accelerate-stop distance required or the take-off run required whichever is greater. The take-off distance available should be the length of the runway plus the length of clearway.
- (j) The minimum runway length and the maximum stopway or clearway length to be provided may be determined as follows, from the data in the aeroplane flight manual for the aeroplane considered to be critical from the viewpoint of runway length requirements:
  - (1) If a stopway is economically possible, the lengths to be provided are those for the balanced field length. The runway length is the take-off run required or the landing distance required whichever is greater. If the accelerate-stop distance required is greater than the runway length so determined, the excess may be provided as stopway, usually at each end of the runway. In addition, a clearway of the same length as the stopway should also be provided;
  - (2) If a stopway is not to be provided, the runway length is the landing distance required, or if it is greater, the accelerate-stop distance required, which corresponds to the lowest practical value of the decision speed. The excess of the take-off distance required over the runway length may be provided as clearway, usually at each end of the runway.
- (k) In addition to the above consideration, the concept of clearways in certain circumstances can be applied to a situation where the take-off distance required for all engines operating exceeds that required for the engine failure case.

## CS ADR-DSN.B.200 Stopways

ED Decision 2016/027/R

- (a) The inclusion of detailed specifications for stopways below is not intended to imply that a stopway has to be provided.
- (b) Width of stopways:  
A stopway should have the same width as the runway with which it is associated.
- (c) Slopes on stopways:  
Slopes and changes in slope on a stopway, and the transition from a runway to a stopway, should comply with the specifications in [CS ADR-DSN.B.060](#) to [CS ADR-DSN.B.080](#) for the runway with which the stopway is associated except that:
- (1) the limitation in [CS ADR-DSN.B.060\(b\)](#) of a 0.8 per cent slope for the first and last quarter of the length of a runway need not be applied to the stopway; and
  - (2) at the junction of the stopway and runway and along the stopway the maximum rate of slope change may be 0.3 per cent per 30 m (minimum radius of curvature of 10 000 m) for a runway where the code number is 3 or 4.
- (d) Strength of stopways:  
A stopway should be prepared or constructed so as to be capable, in the event of an abandoned take-off, of supporting the aeroplane which the stopway is intended to serve without inducing structural damage to the aeroplane.
- (e) Surface of stopways:  
The surface of a paved stopway should be so constructed or resurfaced as to provide surface friction characteristics at or above those of the associated runway.

[Issue: ADR-DSN/3]

## GM1 ADR-DSN.B.200 Stopways

ED Decision 2016/027/R

- (a) The transition from one slope to another should be accomplished by a curved surface with a rate of change not exceeding:
- (1) 0.3 % per 30 m (minimum radius of curvature of 10 000 m) where the code number is 3 or 4; and
  - (2) 0.4 % per 30 m (minimum radius of curvature of 7 500 m) where the code number is 1 or 2.
- (b) The friction characteristics of an unpaved stopway should not be substantially less than that of the runway with which the stopway is associated.
- (c) The economy of a stopway can be entirely lost if, after each usage, it should be regraded and compacted. Therefore, it should be designed to withstand at least a certain number of loadings of the aeroplane which the stopway is intended to serve without inducing structural damage to the aeroplane. Notwithstanding that a stopway may have a paved surface, it is not intended that PCN Figures need to be developed for a stopway. Further guidance is given in ICAO Doc 4444, PANS-OPS.

[Issue: ADR-DSN/3]



## CS ADR-DSN.B.205 Radio altimeter operating area

ED Decision 2016/027/R

- (a) A radio altimeter operating area should be established in the pre-threshold area of a precision approach runway Category II and III, and where practicable, in the pre-threshold area of a precision approach runway Category I.
- (b) Length of the area:  
A radio altimeter operating area should extend before the threshold for a distance of at least 300 m.
- (c) Width of the area:  
A radio altimeter operating area should extend laterally, on each side of the extended centre line of the runway, to a distance of 60 m, except that, when special circumstances so warrant, the distance may be reduced to no less than 30 m if a safety assessment indicates that such reduction would not affect the safety of operations of aircraft.

[Issue: ADR-DSN/3]

## GM1 ADR-DSN.B.205 Radio altimeter operating area

ED Decision 2016/027/R

- (a) In order to accommodate aeroplanes making auto-coupled approaches and automatic landings (irrespective of weather conditions), it is desirable that slope changes be avoided or kept to a minimum, on a rectangular area at least 300 m long before the threshold of a precision approach runway. The area should be symmetrical about the extended centre line, 120 m wide. When special circumstances so warrant, the width may be reduced to no less than 60 m if a safety assessment indicates that such reduction would not affect the safety of operations of aircraft. This is desirable because these aeroplanes are equipped with a radio altimeter for final height and flare guidance, and when the aeroplane is above the terrain immediately prior to the threshold, the radio altimeter should begin to provide information to the automatic pilot for auto-flare. Where slope changes cannot be avoided, the rate of change between two consecutive slopes should not exceed 2 % per 30 m.
- (b) With a radio altimeter operating area in the pre-threshold area of a precision approach runway the margin to calculate the decision altitude should be smaller and the usability of the adjacent runway may be enhanced.
- (c) Further guidance on radio altimeter operating area is given in ICAO Doc 9365, Manual of All-Weather Operations, Section 5.2. Guidance on the use of radio altimeter is given in the ICAO, PANS-OPS, Volume II, Part II, Section 1.

[Issue: ADR-DSN/3]

## CHAPTER C — RUNWAY END SAFETY AREA

### CS ADR-DSN.C.210 Runway end safety areas (RESA)

ED Decision 2016/027/R

- (a) The safety objective of the runway end safety area (RESA) is to minimise risks to aircraft and their occupants when an aeroplane overruns or undershoots a runway.
- (b) A runway end safety area should be provided at each end of a runway strip where:
  - (1) the code number is 3 or 4; and
  - (2) the code number is 1 or 2 and the runway is an instrument one.
- (c) Where practicable, a runway end safety area should be provided at each end of a runway strip where the code number is 1 or 2 and the runway is a non-instrument one.

[Issue: ADR-DSN/3]

### GM1 ADR-DSN.C.210 Runway end safety areas (RESA)

ED Decision 2016/027/R

- (a) General
  - (1) A runway end safety area should provide an area long and wide enough, and suitable to contain overruns and undershoots resulting from a reasonably probable combination of adverse operational factors. On a precision approach runway, the ILS localiser is normally the first upstanding obstacle, and the runway end safety area should extend up to this facility. In other circumstances, the first upstanding obstacle may be a road, a railroad, or other constructed or natural feature. The provisions of a runway end safety area should take such obstacle into consideration.
  - (2) Whatever length of RESA is provided, it is important to ensure that likelihood of, and potential impacts arising from an overrun are minimised as far as reasonably practicable.
  - (3) It is recognised that achieving the recommended distance could present challenges. Therefore, the aim of this guidance is to identify the types of aerodrome activities that can be undertaken to reduce the likelihood and consequences of an overrun occurring, and to decide on appropriate actions and it is suggested that aerodrome operators assess their RESA provisions.
  - (4) The overrun is a complex risk to assess because there are a number of variables, such as prevailing weather, type of aeroplane, the landing aids available, runway characteristics and available distances, the surrounding environment, and human factors. Each of these can have a significant contribution to the overall hazard; furthermore, the nature of the hazard and level of risk should be different for each aerodrome and even for each runway direction at any one aerodrome. The aerodrome may address some, and these are included below. Additionally, aircraft operating procedures may impact but the aerodrome may have little ability to influence these. This should not prevent aerodromes from working with aircraft operators so that the operations are conducted so as to minimise the likelihood of an overrun occurring.
  - (5) Noting the requirement for a runway end safety area (RESA) consideration should be given to providing an area long enough to contain overruns and undershoots resulting from a reasonably probable combination of adverse operational factors. Therefore,

aerodromes should try to maximise the length of RESA available on all applicable runways. When considering the RESA distance required for individual circumstances, aerodromes operators should take into account factors, such as:

- (i) the runway length and slope, in particular the general operating lengths required for take-off and landing versus the runway distances available, including the excess of available length over that required;
- (ii) current RESA provision (length & width – how much the RESA complies with the recommended distance) and options to increase or improve this;
- (iii) the nature and location of any hazard beyond the runway end, including the topography and obstruction environment in and beyond the RESA and outside the runway strip;
- (iv) the type of aeroplane and level of traffic at the aerodrome, and actual or proposed changes to either;
- (v) aircraft performance limitations arising from runway and RESA length – high performance aircraft, operating at high loads and speeds have greater length requirements than smaller, low-performance aircraft, the relationship between required balanced field length and available distances;
- (vi) navigation aids available (PBN, instrument or visual - if an ILS is only available on one runway direction, a downwind approach and landing may be necessary in poor weather) and the availability of vertical guidance ;
- (vii) friction and drainage characteristics of the runway, which impact on runway susceptibility to surface contamination and aeroplane braking action;
- (viii) traffic density, which may lead to increased pressure to vacate so increased speed;
- (ix) aerodrome weather patterns, including wind shear;
- (x) aerodrome overrun history; and
- (xi) overrun/undershoot causal factors.

(b) Assessment of runway end safety areas

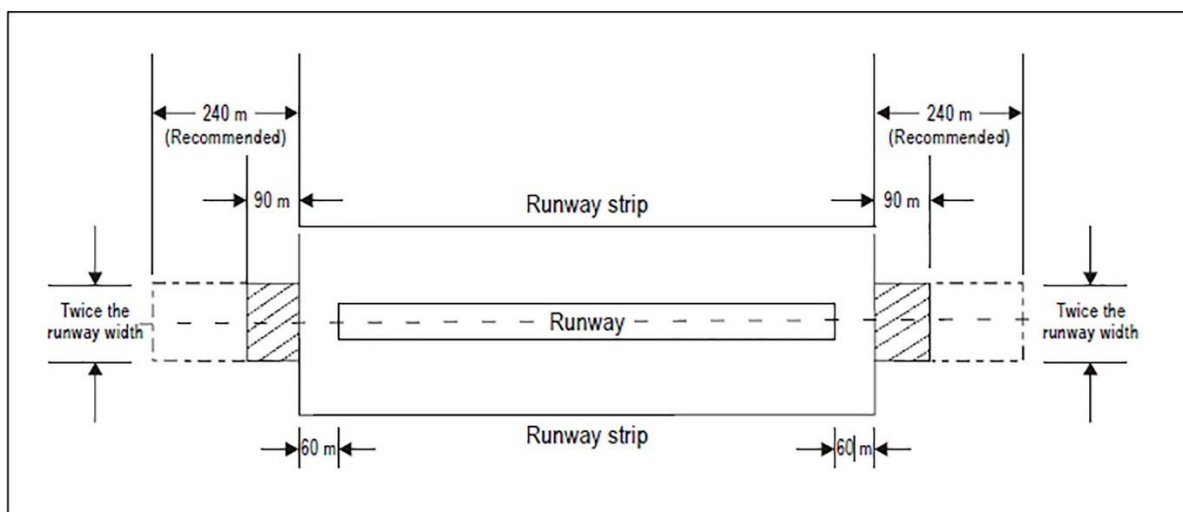
- (1) The RESA assessment should help the aerodrome operator identify the hazards and appropriate actions to reduce the risk. A range of measures may be available, singly or in combination, to reduce the risks of an overrun occurring or becoming an accident. Measures aimed at reducing the likelihood of an overrun/undershoot include:
  - (i) improving runway surfaces and friction measurement, particularly when the runway is contaminated — know your runways and their condition and characteristics in precipitation;
  - (ii) ensuring that accurate and up-to-date information on weather, the runway state and characteristics, is notified and passed to flight crews in a timely way, particularly when flight crews need to make operational adjustments;
  - (iii) improving an aerodrome management's knowledge, recording, prediction and dissemination of wind data, including wind shear, and any other relevant weather information, particularly when it is a significant feature of an aerodrome's weather pattern;

- (iv) upgrading visual and instrument landing aids to improve the accuracy of aeroplane delivery at the correct landing position on runways (including the provision of Instrument Landing PBN approach systems, location of aiming point and harmonisation with PAPIs);
  - (v) formulating, in consultation with aeroplane operators, adverse weather and any other relevant aerodrome operating procedures or restrictions, and promulgating such information appropriately; and
  - (vi) working with aircraft operators to optimise the operation.
- (2) Combined with this, measures may be considered that would reduce the severity of the consequences should an event occur. Wherever practicable, aerodrome operators should seek to optimise the RESA. This may be achieved through a combination of:
- (i) relocation, shifting or realignment of the runway — it may be possible to construct additional pavement at the start of take-off end to make more pavement available to retain the declared distances. The start and end of declared distances can be moved towards the downwind (start of take-off) end, thereby retaining the declared distance and creating space for a longer RESA, as shown in [GM1 ADR-DSN.B.035](#);
  - (ii) in the case where undershoot RESA is limited and the runway has a displaced landing threshold, examine whether the threshold can be moved (downwind) to increase the RESA and/or runway length;
  - (iii) reducing runway declared distances in order to provide the necessary RESA may be a viable option where the existing runway length exceeds that required for the existing or projected design aircraft. If the take-off distance required for the critical aircraft operating at the aerodrome is less than the take-off distance available, there may be an opportunity to reduce the relevant runway declared distances. Where provision of a runway end safety area would be particularly prohibitive to implement consideration would have to be given to reducing some of the declared distances of the runway for the provision of a runway end safety area and/or installation of an arresting system;
  - (iv) increasing the length of a RESA, and/or minimising the obstruction environment in the area beyond the RESA. Means to increase the RESA provision include land acquisition, improvements to the grading, realigning fences or roads to provide additional area;
  - (v) installing suitably positioned and designed arresting systems, to supplement or as an alternative to a RESA where an equivalent level of safety is demonstrated;
  - (vi) improving the slopes in the RESA to minimise or remove downward slopes; and
  - (vii) providing paved RESA with known friction characteristics.
- (3) A runway meant for take-off and landing in both directions should have 2 RESAs extending for the required distance beyond the end of the strip extending from the runway end. Depending of the position of the threshold on a runway, the RESA related to the reverse runway should protect aircraft undershooting the threshold. Assessments of overruns and undershoots have shown that the likelihood of an undershoot is approximately four times less than for an overrun. Additionally, the undershoot rate shows that the likelihood of an event is further reduced by the availability of precision approach aids, especially those with vertical guidance. Therefore, on a precision

approach runway consideration may include whether to reduce the minimum length of RESA towards the length of the runway strip before the runway.

- (4) It is recognised that improving RESAs is often difficult. However, it is important to note that incremental gains should be obtained wherever possible, as any gain is valuable. Therefore, whenever a runway project involves construction, consideration should also be given to improving the RESA.
  - (5) The above lists are not in any particular order, are not exhaustive, and should complement action by aeroplane operators, designers and aviation regulators.
  - (6) RESA provision should be considered by the Local Runway Safety Team.
- (c) Arresting systems on runway end safety areas
- (1) In recent years, recognising the difficulties associated with achieving a standard runway end safety area (RESA) at all aerodromes, research programmes have been undertaken on the use of various materials for arresting systems. Furthermore, research programmes have been undertaken to evaluate and develop arrestor systems using engineered materials. This research was driven by the recognition that many runways where natural obstacles, local development, and/or environmental constraints inhibit the provision of RESA and lead to limited dimension of RESA. Additionally, there had been accidents at some aerodromes where the ability to stop an overrunning aeroplane within the RESA would have prevented major damage to aeroplane and/or injuries to passengers.
  - (2) The research programmes, as well as evaluation of actual aeroplane overruns into arresting system, have demonstrated that the performance of some arresting systems can be predictable and effective in arresting aeroplane overruns.
  - (3) Arresting system designs should be supported by a validated design method that can predict the performance of the system. The design method should be derived from field or laboratory tests. Testing may be based either on passage of an actual aircraft or an equivalent single wheel load through a test bed. The design should consider multiple aircraft parameters, including but not limited to allowable aircraft gear loads, gear configuration, tire contact pressure, aircraft centre of gravity, and aircraft speed. The model should calculate imposed aircraft gear loads, g-forces on aircraft occupants, deceleration rates, and stopping distances within the arresting system. Any rebound of the crushed material that may lessen its effectiveness, should also be considered.
  - (4) Demonstrated performance of an arresting system can be achieved by a validated design method which can predict the performance of the system. The design and performance should be based on the type of aeroplane anticipated to use the associated runway that imposes the greatest demand upon the arresting system. The design of an arresting system should be based on a critical (or design) aircraft which is defined as aircraft using the associated runway that imposes the greatest demand upon the arresting system. This is usually but not always, the heaviest/largest aircraft that regularly uses the runway. Arresting system performance is dependent not only on aircraft weight but allowable aeroplane gear loads, gear configuration, tire contact pressure, aeroplane centre of gravity and aeroplane speed. Accommodating undershoots should also be addressed. All configurations should be considered in optimising the arresting system design. The aerodrome operator and arresting system manufacturer should consult regarding the selection of the design aeroplane that should optimise the arresting system for a particular aerodrome. Additionally, the design should allow the safe operation of fully loaded rescue and fire fighting vehicles, including their ingress and egress.

- (5) Additional information is given in ICAO Doc 9157, Aerodrome Design Manual, Part 1, Runways.



**Figure GM-C-1. Runway end safety area for a runway where the code number is 3 or 4**

[Issue: ADR-DSN/3]

## CS ADR-DSN.C.215 Dimensions of runway end safety areas

ED Decision 2016/027/R

- (a) Length of runway end safety area
- (1) A runway end safety area should extend from the end of a runway strip to a distance of at least 90 m and, as far as practicable, extend to a distance of:
    - (i) 240 m where the code number is 3 or 4 and
    - (ii) 120 m where the code number is 1 or 2 and the runway is an instrument one; and
  - (2) A runway end safety area should extend from the end of a runway strip, as far as practicable, to a distance of 30 m where the code number is 1 or 2 and the runway is a non-instrument one.
- (b) Notwithstanding the provisions in (a) above, the length of the runway end safety area may be reduced where an arresting system is installed, based on the design specifications of the system.
- (c) Width of runway end safety area
- The width of a runway end safety area should be at least twice that of the associated runway and, wherever practicable, be equal to that of the graded portion of the associated runway strip.

[Issue: ADR-DSN/3]

## GM1 ADR-DSN.C.215 Dimensions of runway end safety areas

ED Decision 2014/013/R

It is accepted that many aerodromes were constructed before requirements for RESAs were introduced. For applicable runways where the RESA does not extend to the recommended distance, as part of their Safety Management System, aerodromes should assess the risk and implement appropriate and suitable mitigation measures as necessary.

## CS ADR-DSN.C.220 Objects on runway end safety areas

ED Decision 2014/013/R

No fixed object, other than equipment and installations required for air navigation or for aeroplane safety purposes and satisfying the relevant frangibility requirement [CS ADR-DSN.T.910](#), should be permitted on a runway end safety area. The detailed requirements for siting objects on a RESA are in [CS ADR-DSN.T.915](#).

## GM1 ADR-DSN.C.220 Objects on runway end safety areas

ED Decision 2014/013/R

Information regarding siting of equipment and installations on operational areas, including RESA, is detailed in [CS ADR-DSN.T.915](#).

## CS ADR-DSN.C.225 Clearing and grading of runway end safety areas

ED Decision 2014/013/R

A runway end safety area should provide a cleared and graded area for aeroplanes which the runway is intended to serve in the event of an aeroplane undershooting or overrunning the runway.

## GM1 ADR-DSN.C.225 Clearing and grading of runway end safety areas

ED Decision 2016/027/R

- (a) The surface of the runway end safety area should be prepared but does not need to be prepared to the same quality as the runway strip.
- (b) Guidance on clearing and grading of runway end safety areas is given in ICAO Doc 9157, Aerodrome Design Manual, Part 1, Runways.

[Issue: ADR-DSN/3]

## CS ADR-DSN.C.230 Slopes on runway end safety areas

ED Decision 2014/013/R

- (a) Longitudinal slopes
  - (1) The slopes of a runway end safety area should be such that no part of the runway end safety area penetrates the approach or take-off climb surface.
  - (2) The longitudinal slopes of a runway end safety area should not exceed a downward slope of 5 %. Longitudinal slope changes should be as gradual as practicable, and abrupt changes or sudden reversals of slopes should be avoided.
- (b) Transverse slopes

The transverse slopes of a runway end safety area should not exceed an upward or downward slope of 5 %. Transitions between differing slopes should be as gradual as practicable.

## GM1 ADR-DSN.C.230 Slopes on runway end safety areas

ED Decision 2014/013/R

Where clearway is provided, the slope on the RESA should be amended accordingly.

## CS ADR-DSN.C.235 Strength of runway end safety areas

*ED Decision 2016/027/R*

A runway end safety area should have a bearing strength sufficient to serve its primary purpose.

[Issue: ADR-DSN/3]

## GM1 ADR-DSN.C.235 Strength of runway end safety areas

*ED Decision 2016/027/R*

- (a) A runway end safety area should be so prepared or constructed as to reduce the risk of damage to an aeroplane undershooting or overrunning the runway, enhance aeroplane deceleration, and facilitate the movement of rescue and firefighting vehicles.
- (b) Guidance on the strength of a runway end safety area is given in the [GM1 ADR-DSN.B.190](#) Strength of runway strips and in ICAO Doc 9157, Aerodrome Design Manual, Part 1, Runways.

[Issue: ADR-DSN/3]



## CHAPTER D — TAXIWAYS

### CS ADR-DSN.D.240 Taxiways general

ED Decision 2017/021/R

Unless otherwise indicated, the requirements in Chapter D - Taxiways are applicable to all types of taxiways.

- (a) The design of a taxiway should be such that, when the cockpit of the aeroplane for which the taxiway is intended, remains over the taxiway centre line markings, the clearance distance between the outer main wheel of the aeroplane and the edge of the taxiway should be not less than that given by the following tabulation:

Clearance	Outer Main Gear Wheel Span (OMGWS)			
	Up to but not including 4.5 m	4.5 m up to but not including 6 m	6 m up to but not including 9 m	9 m up to but not including 15 m
	1.50 m	2.25 m	3 m <sup>a,b</sup> or 4 m <sup>c</sup>	4 m

<sup>a</sup> on straight portions.

<sup>b</sup> on curved portions if the taxiway is intended to be used by aeroplanes with a wheel base of less than 18 m.

<sup>c</sup> on curved portions if the taxiway is intended to be used by aeroplanes with a wheel base equal to or greater than 18 m.

Note: Wheel base means the distance from the nose gear to the geometric centre of the main gear.

[Issue: ADR-DSN/4]

### GM1 ADR-DSN.D.240 Taxiways general

ED Decision 2017/021/R

- (a) Taxiways should be provided to permit the safe and expeditious surface movement of aircraft. Sufficient entrance and exit taxiways for a runway should be provided to expedite the movement of aeroplanes to and from the runway and provision of rapid exit taxiways considered when traffic volumes are high.
- (b) Design of runway and taxiway infrastructure that either prevents aircraft entering or crossing a runway or mitigates the risk of an aircraft runway incursion collision should be considered both in the development of any new infrastructure and as a retrospective enhancement to existing infrastructure especially in hot-spot areas (areas where risk appraisal or incident data demonstrates a higher risk). This guidance may be considered as part of a runway incursion prevention programme and to help ensure that runway incursion aspects are addressed in any new design proposal.
- (c) The initial approach should be to reduce the number of available entrances to the runway, so that the potential for entry to the runway at an unintended location is minimised. Taxiway entry, crossing and runway exit taxiways should be clearly identified and promulgated, using taxiing guidance signs, lighting and pavement markings.
- (d) Many aerodromes have more than one runway, notably paired parallel runways (two runways on one side of the terminal apron), which create a difficult problem in that either on arrival or departure an aircraft is required to cross a runway. The potential for runway crossings should be eliminated or at least be as low as reasonably practicable. This may be achieved by constructing a 'perimeter taxiway' to enable aircraft to get to the departure runway or to the apron without either crossing a runway, or conflicting with an approaching or departing aircraft.

- (e) A perimeter taxiway is ideally designed according to the following criteria:
- (1) Sufficient space is required between the landing threshold and the taxiway centre line where it crosses under the approach path, to enable the critical aeroplane to pass under the approach without violating the approach surface.
  - (2) The extent of the jet blast impact of aircraft taking off is considered when determining the location of a perimeter taxiway.
  - (3) The requirement for RESA, as well as possible interference with the ILS or other navigation aids is also taken into account: the perimeter taxiway is located behind the localiser antenna, not between the localiser antenna and the runway, due to the potential for severe ILS disturbance, noting that this is harder to achieve as the distance between the localiser and the runway increases. Likewise, perimeter roads are provided where possible.
  - (4) Appropriate measures should be considered in order to assist pilots to distinguish between aircraft that are crossing the runway and those that are safely on a perimeter taxiway.
- (f) Taxiways crossing runways should be provided at low energy locations, preferably at the runway ends. Where runway crossings cannot be eliminated, they should only be done on taxiways at right angles to a runway. This will afford the flight crew an unobstructed view of the runway, in both directions, to confirm that the runway and approach is clear of conflicting traffic before proceeding across.
- (g) The runway/taxiway junction configuration should be simple, for example with single taxiway entrances; this is particularly relevant for taxiways crossing runways.
- (h) The main design principles for entry and exit taxiways are:
- (1) Taxiways should be perpendicular to the runway centre line if possible.
  - (2) The taxiway angle should be such that the crew of an aircraft at a taxiway holding position (if any) should be able to see an aircraft using or approaching the runway. Where the taxiway angle is such that this clear view, in both directions is not possible, consideration is given to provide a perpendicular portion of the taxiway immediately adjacent to the runway to allow for a full visual scan prior to entering (or crossing).
  - (3) Rapid exit taxiways are designed to be runway exits. Whilst it may be an operational practice at some airports to allow smaller aircraft the option of departing at a mid-point on the runway from one of these rapid exit taxiways, the geometry of the taxiway/runway intersection does not allow the crew to properly scan the runway in both directions to confirm that there is no conflicting traffic. This practice should thus be eliminated and from the design point of view, all signage and markings should deter any aircraft from using these rapid exit taxiways for any purpose other than what they are designed for (exiting the runway after landing). However, this may be mitigated by the addition of a fillet so that aircraft can manoeuvre to see down the approach. Note that aircraft on an angled taxiway may have a greater likelihood of causing ILS interference.
  - (4) A clear separation of pavement between a rapid exit taxiway and other non-rapid taxiways entering or crossing a runway should be provided. This design principle prevents two taxiways from overlapping with each other and creating an excessive paved area that would confuse pilots entering a runway.
  - (5) Limiting the options available to pilots on each entrance or exit helps to avoid confusion. Therefore, avoid dual or multiple taxiway entrances at one location, as Y-shaped

connectors present opportunities for runway incursions and for aircraft vacating the runway to enter the wrong taxiway. Limiting the options available to pilots on each entrance or exit helps to avoid confusion.

- (6) Runway/taxiway separations should be sufficient to permit space for effective RETs.
  - (7) Avoid designs which include crossing a runway to access a taxiway.
  - (8) Provide clear separation between high speed (RET) and taxi speed runway exits; if RETs are provided have a series in a row without other entrances.
  - (9) Where the aerodrome has more than one runway, ensure that runway ends are not too close together; if this is not possible ensure that they are clearly identified as separated. This may be achieved through visual aids, taxiway design and the taxiway naming convention.
  - (10) Surface colour should not create confusion:
    - (i) Have different colours for runway and taxiways.
    - (ii) Avoid a mix of concrete & asphalt.
  - (11) Wide taxiway entrances onto runways should be broken up with islands or barriers or painting taxiway edges with continuous edge markings to indicate unusable pavement. Avoid long holding position lines and excess paved areas which reduce the effectiveness of signs and markings. Use standard taxiway widths, suitable for a wide range of aeroplane, including the largest type expected to use the aerodrome.
  - (12) Avoid multi-taxiway intersections and reduce the number of taxiways at any intersection as far as possible.
  - (13) As far as practicable, it is preferable to redesign rather than reconfigure or repaint where possible – design errors out and reduce potential for human error.
  - (14) Consistent design of runway entrances – same visual aids at each, both taxiways and service road accesses.
  - (15) It is always preferable for safety reasons to have a taxiway parallel to the runway all along the runway, even if capacity constraints do not make it necessary.
- (i) Aerodrome infrastructure can also be used to support design, whether by the systems installed or by their operating characteristics. Examples include:
- (1) Stopbars and runway guard lights should be provided at all entrances, and preferably illuminated H24 and in all weather conditions. Runway incursions do not happen only under restricted visibilities. In fact, more incursions happen when the weather is good.
  - (2) Avoid confusion between CAT I and CAT III holding positions. This may be achieved in some circumstances by combining both holding positions.
- (j) Multi-taxiway entrances to a runway should be parallel to each other and should be distinctly separated by an unpaved area. This design principle allows each runway holding location an earthen area for the proper placement of accompanying sign, marking, and lighting visual cues at each runway holding position. Moreover, the design principle eliminates the construction of unusable pavement and as well as the painting of taxiway edge markings to indicate such unusable pavement. In general, excess paved areas at runway holding positions reduce the effectiveness of sign, marking, and lighting visual cues.
- (k) Guidance on layout of taxiways is given in ICAO Doc 9157, Aerodrome Design Manual, Part 2, Taxiways, Aprons and Holding Bays.

[Issue: ADR-DSN/3]  
 [Issue: ADR-DSN/4]

## CS ADR-DSN.D.245 Width of taxiways

*ED Decision 2017/021/R*

A straight portion of a taxiway should have a width of not less than that given by the following tabulation:

	Outer Main Gear Wheel Span (OMGWS)			
	Up to but not including 4.5 m	4.5 m up to but not including 6 m	6 m up to but not including 9 m	9 m up to but not including 15 m
Taxiway width	7.5 m	10.5 m	15 m	23 m

[Issue: ADR-DSN/4]

## GM1 ADR-DSN.D.245 Width of taxiways

*ED Decision 2017/021/R*

- The width of the taxiway should be measured at the edge of the paved surface, or where the taxiway edge is marked, at the outside edge of the taxiway edge marking.
- Additional guidance on width of taxiways is given in ICAO Doc 9157, Aerodrome Design Manual, Part 2, Taxiways, Aprons and Holding Bays.

[Issue: ADR-DSN/4]

## CS ADR-DSN.D.250 Taxiways curves

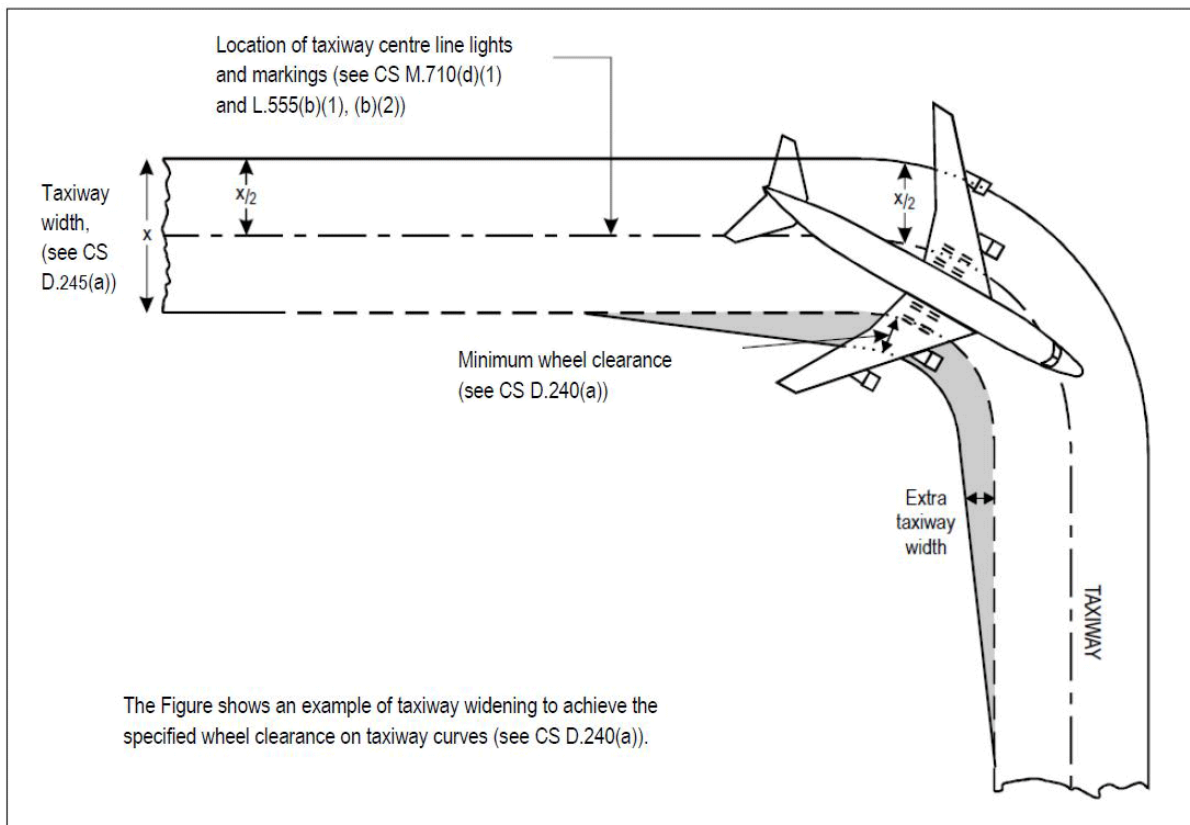
*ED Decision 2014/013/R*

- Changes in direction of taxiways should be as few and small as possible. The radii of the curves should be compatible with the manoeuvring capability and normal taxiing speeds of the aeroplanes for which the taxiway is intended.
- The design of the curve should be such that when the cockpit of the aeroplane for which the taxiway is intended remains over the taxiway centre line markings, the clearance distance between the outer main wheels of the aeroplane and the edge of the taxiway should be not less than those specified in [CS ADR-DSN.D.240](#).

## GM1 ADR-DSN.D.250 Taxiways curves

*ED Decision 2016/027/R*

- The location of taxiway centre line markings and lights is specified in [CS ADR-DSN.L.555](#) and [CS ADR-DSN.M.710](#).
- Compound curves may reduce or eliminate the need for extra taxiway width.
- An example of widening taxiways to achieve the wheel clearance specified is illustrated in Figure GM-D-1. Guidance on the values of suitable dimensions is given in ICAO Doc 9157, Aerodrome Design Manual, Part 2, Taxiways, Aprons and Holding Bays.



**Figure GM-D-1. Taxiway curve**

[Issue: ADR-DSN/3]

## CS ADR-DSN.D.255 Junction and intersection of taxiways

ED Decision 2014/013/R

- (a) To facilitate the movement of aeroplanes, fillets should be provided at junctions and intersections of taxiways with runways, aprons, and other taxiways.
- (b) The design of the fillets should ensure that the minimum wheel clearances specified in [CS ADR-DSN.D.240](#) are maintained when aeroplanes are manoeuvring through the junctions or intersections.

## GM1 ADR-DSN.D.255 Junction and intersection of taxiways

ED Decision 2016/027/R

Consideration should be given to the aeroplane datum length when designing fillets. Guidance on the design of fillets and the definition of the term aeroplane datum length are given in ICAO Doc 9157, Aerodrome Design Manual, Part 2, Taxiways, Aprons and Holding Bays.

[Issue: ADR-DSN/3]

## CS ADR-DSN.D.260 Taxiway minimum separation distance

ED Decision 2017/021/R

- (a) The safety objective of minimum taxi separation distances is to allow safe use of taxiways and aircraft stand taxilanes to prevent possible collision with other aeroplanes operating on adjacent runways or taxiways, or collision with adjacent objects.
- (b) The separation distance between the centre line of a taxiway and the centre line of a runway, the centre line of a parallel taxiway or an object should not be less than the appropriate dimension specified in Table D-1.

Code letter	Distance between taxiway centre line and runway centre line (metres)								Taxiway centre line to taxiway centre line (metres)	Taxiway, other than aircraft stand taxilane, centre line to object (metres)	Aircraft stand taxilane centre line to aircraft stand taxilane centre line (metres)	Aircraft stand taxilane centre line to object (metres)
	Instrument runways				Non-instrument runways							
	Code number				Code number							
1	2	3	4	1	2	3	4					
(1)	(2)	(3)	(4)	(5)	(6)	(7)	(8)	(9)	(10)	(11)	(12)	(13)
A	77.5	77.5	—	—	37.5	47.5	—	—	23	15.5	19.5	12
B	82	82	152	—	42	52	87	—	32	20	28.5	16.5
C	88	88	158	158	48	58	93	93	44	26	40.5	22.5
D	—	—	166	166	—	—	101	101	63	37	59.5	33.5
E	—	—	172.5	172.5	—	—	107.5	107.5	76	43.5	72.5	40
F	—	—	180	180	—	—	115	115	91	51	87.5	47.5

Note 1: The separation distances shown in columns (2) to (9) represent ordinary combinations of runways and taxiways.

Note 2: The distances in columns (2) to (9) do not guarantee sufficient clearance behind a holding aeroplane to permit the passing of another aeroplane on a parallel taxiway.

Table D-1. Taxiway minimum separation distances

[Issue: ADR-DSN/2]

[Issue: ADR-DSN/4]

## GM1 ADR-DSN.D.260 Taxiway minimum separation distance

ED Decision 2017/021/R

- (a) Guidance on factors which may be considered in the safety assessment is given in ICAO Doc 9157, Aerodrome Design Manual, Part 2, Taxiways, Aprons and Holding Bays.
- (b) ILS and MLS installations may also influence the location of taxiways due to interferences to ILS and MLS signals by a taxiing or stopped aircraft. Information on critical and sensitive areas surrounding ILS and MLS installations is contained in ICAO, Annex 10, Volume I, Attachments C and G (respectively).
- (c) The separation distances, as prescribed in Table D-1, column (10), do not necessarily provide the capability of making a normal turn from one taxiway to another parallel taxiway. Guidance for this condition is given in ICAO Doc 9157, Aerodrome Design Manual, Part 2, Taxiways, Aprons and Holding Bays.
- (d) The separation distance between the centre line of an aircraft stand taxilane and an object, as prescribed in Table D-1, column (13), may need to be increased when jet exhaust wake velocity may cause hazardous conditions for ground servicing.
- (e) It may be permissible to operate with lower separation distances at an existing aerodrome if a safety assessment indicates that such lower separation distances would not adversely affect the safety or significantly affect the regularity of operations of aeroplanes.
- (f) The separation distances, as prescribed in Table D-1, may have to be increased on taxiway curves to accommodate the wing sweep of the critical aeroplane or on dual parallel taxiways when, as for example, used as bypass taxiways.
- (g) The requirements for apron taxiways regarding strip width, separation distances, etc., are the same as for any other type of taxiway.

[Issue: ADR-DSN/2]

[Issue: ADR-DSN/3]

[Issue: ADR-DSN/4]

## CS ADR-DSN.D.265 Longitudinal slopes on taxiways

ED Decision 2014/013/R

- (a) The safety objective of limiting the longitudinal taxiway slope is to enable stabilised safe use of taxiway by an aircraft.
- (b) The longitudinal slope of a taxiway should not exceed:
  - (1) 1.5 % where the code letter is C, D, E, or F; and
  - (2) 3 % where the code letter is A or B.

## GM1 ADR-DSN.D.265 Longitudinal slopes on taxiways

ED Decision 2014/013/R

intentionally left blank

**CS ADR-DSN.D.270 Longitudinal slope changes on taxiways**

ED Decision 2014/013/R

- (a) The safety objective of limiting the longitudinal taxiway slope changes is to avoid damage of aircraft and to enable safe use of taxiway by an aircraft.
- (b) Where slope changes on a taxiway cannot be avoided, the transition from one slope to another slope should be accomplished by a curved surface with a rate of change not exceeding:
  - (1) 1 % per 30 m (minimum radius of curvature of 3 000 m) where the code letter is C, D, E, or F; and
  - (2) 1 % per 25 m (minimum radius of curvature of 2 500 m) where the code letter is A or B.
- (c) Where slope changes in (b)(1) and (2) are not achieved and slopes on a taxiway cannot be avoided, the transition from one slope to another slope should be accomplished by a curved surface which should allow the safe operation of all aircraft in all weather conditions.

**GM1 ADR-DSN.D.270 Longitudinal slope changes on taxiways**

ED Decision 2014/013/R

intentionally left blank

**CS ADR-DSN.D.275 Sight distance of taxiways**

ED Decision 2014/013/R

- (a) The safety objective of minimum taxiway sight distance values is to achieve the necessary visibility to enable safe use of taxiway by an aircraft.
- (b) Where a change in slope on a taxiway cannot be avoided, the change should be such that, from any point:
  - (1) 3 m above the taxiway, it should be possible to see the whole surface of the taxiway for a distance of at least 300 m from that point where the code letter is C, D, E, or F;
  - (2) 2 m above the taxiway, it should be possible to see the whole surface of the taxiway for a distance of at least 200 m from that point where the code letter is B; and
  - (3) 1.5 m above the taxiway, it should be possible to see the whole surface of the taxiway for a distance of at least 150 m from that point where the code letter is A.

**GM1 ADR-DSN.D.275 Sight distance of taxiways**

ED Decision 2014/013/R

intentionally left blank

**CS ADR-DSN.D.280 Transverse slopes on taxiways**

ED Decision 2014/013/R

- (a) The safety objective of taxiway transverse slopes is to promote the most rapid drainage of water from the taxiway.
- (b) The transverse slopes of a taxiway should be sufficient to prevent the accumulation of water on the surface of the taxiway but should not exceed:
  - (1) 1.5 % where the code letter is C, D, E, or F; and



- (2) 2 % where the code letter is A or B.

## GM1 ADR-DSN.D.280 Transverse slopes on taxiways

ED Decision 2014/013/R

The slopes on a taxiway are intended to prevent the accumulation of water (or possible fluid contaminant) on the surface and to facilitate rapid drainage of surface water (or possible fluid contaminant). Slopes should be so designed as to minimise impact on aircraft and so not to hamper the operation of aircraft.

## CS ADR-DSN.D.285 Strength of taxiways

ED Decision 2014/013/R

The strength of a taxiway should be suitable for the aircraft that the taxiway is intended to serve.

## GM1 ADR-DSN.D.285 Strength of taxiways

ED Decision 2016/027/R

Information regarding pavement bearing strength, including the ACN/PCN classification system may be found in [GM1 ADR-DSN.B.085](#).

Due consideration being given to the fact that a taxiway should be subjected to a greater density of traffic and as a result of slow moving and stationary aeroplanes, to higher stresses than the runway it serves.

[Issue: ADR-DSN/3]

## CS ADR-DSN.D.290 Surface of taxiways

ED Decision 2016/027/R

- (a) The surface of a taxiway should not have irregularities that cause damage to aeroplane structures.
- (b) The surface of a paved taxiway should be so constructed or resurfaced as to provide suitable surface friction characteristics.

[Issue: ADR-DSN/3]

## GM1 ADR-DSN.D.290 Surface of taxiways

ED Decision 2016/027/R

Suitable surface friction characteristics are those surface properties required on taxiways that assure safe operation of aeroplanes.

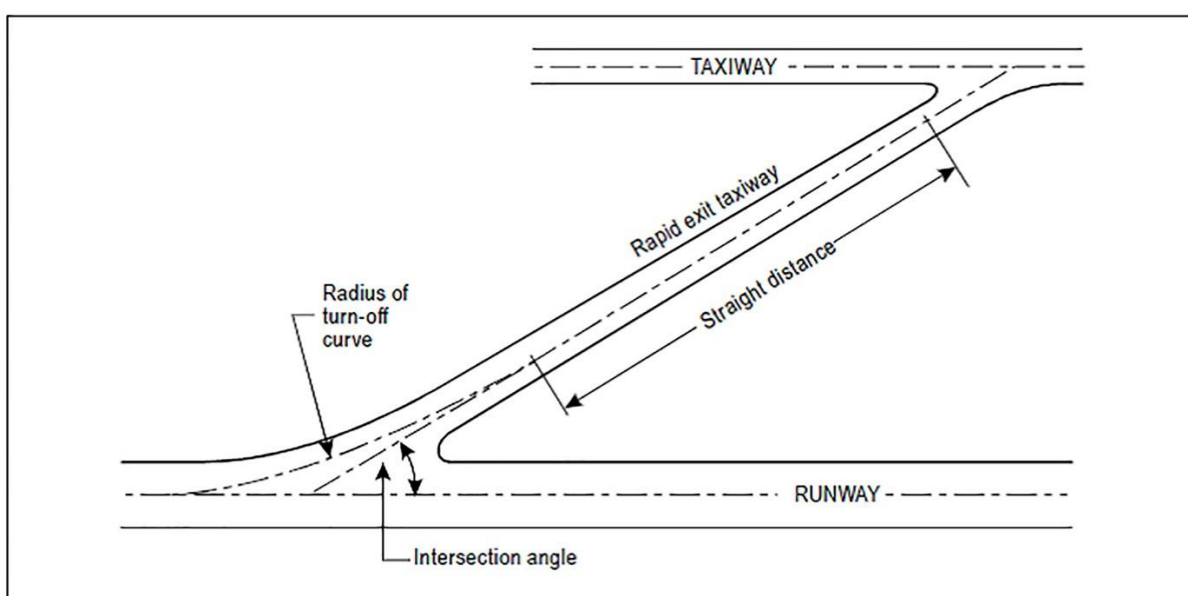
[Issue: ADR-DSN/3]

## CS ADR-DSN.D.295 Rapid exit taxiways

ED Decision 2014/013/R

- (a) The safety objective of rapid exit taxiway is to facilitate safe rapid exit of aeroplanes from a runway.
- (b) A rapid exit taxiway should be designed with a radius of turn-off curve of at least:
  - (1) 550 m where the code number is 3 or 4; and

- (2) 275 m where the code number is 1 or 2;  
 to enable under wet conditions exit speeds of:
- (i) 93 km/h where the code number is 3 or 4; and
  - (ii) 65 km/h where the code number is 1 or 2.
- (c) The radius of the fillet on the inside of the curve at a rapid exit taxiway should be sufficient to provide a widened taxiway throat in order to facilitate early recognition of the entrance and turn-off onto the taxiway.
- (d) A rapid exit taxiway should include a straight distance after the turn-off curve sufficient for an exiting aircraft to come to a full stop clear of any intersecting taxiway (Figure D-1).
- (e) The intersection angle of a rapid exit taxiway with the runway should not be greater than 45°, nor less than 25° and preferably should be 30°.



**Figure D-1. Rapid exit taxiway**

## GM1 ADR-DSN.D.295 Rapid exit taxiways

*ED Decision 2021/004/R*

- (a) The following guidance applies particularly to rapid exit taxiways (see Figure D-1). The general requirements for taxiways, as prescribed in the relevant certification specifications, are also applicable to rapid exit taxiways. Guidance on the provision, location and design of rapid exit taxiways is included in ICAO Doc 9157, Aerodrome Design Manual, Part 2, Taxiways, Aprons and Holding Bays.
- (b) The locations of rapid exit taxiways along a runway are based on several criteria described in ICAO Doc 9157, Aerodrome Design Manual, Part 2, Taxiways, Aprons and Holding Bays, in addition to different speed criteria.

[Issue: ADR-DSN/3]

[Issue: ADR-DSN/5]

## CS ADR-DSN.D.300 Taxiways on bridges

ED Decision 2014/013/R

- (a) The width of that portion of a taxiway bridge capable of supporting aeroplanes, as measured perpendicularly to the taxiway centre line, should not be less than the width of the graded area of the strip provided for that taxiway unless a proven method of lateral restraint is provided which should not be hazardous for aeroplanes for which the taxiway is intended.
- (b) Access should be provided to allow rescue and firefighting vehicles to intervene in both directions within the specified response time to the largest aeroplane for which the taxiway bridge is intended.
- (c) A bridge should be constructed on a straight section of the taxiway with a straight section on both ends of the bridge to facilitate the alignment of aeroplanes approaching the bridge.

## GM1 ADR-DSN.D.300 Taxiways on bridges

ED Decision 2014/013/R

If aeroplane engines overhang the bridge structure, protection of adjacent areas below the bridge from engine blast may be required.

## CS ADR-DSN.D.305 Taxiway shoulders

ED Decision 2017/021/R

- (a) Straight portions of a taxiway where the code letter is C, D, E, or F should be provided with shoulders which extend symmetrically on each side of the taxiway so that the overall width of the taxiway and its shoulders on straight portions is not less than:
  - (1) 44 m where the code letter is F;
  - (2) 38 m where the code letter is E;
  - (3) 34 m where the code letter is D; and
  - (4) 25 m where the code letter is C.
- (b) On taxiway curves and on junctions or intersections where increased pavement is provided, the shoulder width should be not less than that on the adjacent straight portions of the taxiway.
- (c) When a taxiway is intended to be used by turbine-engined aeroplanes, the surface of the taxiway shoulder should be prepared so as to resist erosion and the ingestion of the surface material by aeroplane engines.

[Issue: ADR-DSN/4]

## GM1 ADR-DSN.D.305 Taxiway shoulders

ED Decision 2016/027/R

Guidance on characteristics of taxiway shoulders and on shoulder treatment is given in ICAO Doc 9157, Aerodrome Design Manual, Part 2, Taxiways, Aprons and Holding Bays.

[Issue: ADR-DSN/3]

## CS ADR-DSN.D.310 Taxiway Strip

ED Decision 2014/013/R

A taxiway, other than an aircraft stand taxiway, should be included in a strip.

## GM1 ADR-DSN.D.310 Taxiway Strip

ED Decision 2016/027/R

A taxiway strip should be so prepared or constructed as to minimise hazards arising from differences in load bearing capacity to aeroplanes which the taxiway is intended to serve in the event of an aeroplane accidentally running off the taxiway.

Guidance on characteristics of taxiway strips is given in ICAO Doc 9157, Aerodrome Design Manual, Part 2, Taxiways, Aprons and Holding Bays.

[Issue: ADR-DSN/3]

## CS ADR-DSN.D.315 Width of taxiway strips

ED Decision 2016/027/R

- (a) The safety objective of the width of taxiway strips is to allow safe use of taxiways in relation to adjacent objects.
- (b) A taxiway strip should extend symmetrically on each side of the centre line of the taxiway throughout the length of the taxiway to at least the distance from the centre line given in Table D-1, column (11).

[Issue: ADR-DSN/3]

## GM1 ADR-DSN.D.315 Width of taxiway strips

ED Decision 2014/013/R

intentionally left blank

## CS ADR-DSN.D.320 Objects on taxiway strips

ED Decision 2014/013/R

The taxiway strip should provide an area clear of objects which may endanger taxiing aeroplanes.

## GM1 ADR-DSN.D.320 Objects on taxiway strips

ED Decision 2017/021/R

- (a) Consideration should be given to the location and design of drains on a taxiway strip to prevent damage to an aeroplane accidentally running off a taxiway. Suitably designed drain covers may be required.
- (b) The detailed requirements for siting objects on taxiway strips are in [CS ADR-DSN.T.915](#).
- (c) Where open-air or covered storm water conveyances are installed, consideration should be given in order to ensure that their structure does not extend above the surrounding ground so as not to be considered an obstacle.
- (d) Particular attention needs to be given to the design and maintenance of an open-air storm water conveyance in order to prevent wildlife attraction, in particular birds. The open-air storm water conveyance may be covered by a net, if required. Further guidance is given in ICAO Doc 9137, Airport Services Manual, Part 3, Wildlife Control and Reduction.
- (e) Guidance on the design of drain covers is given in ICAO Doc 9157, Aerodrome Design Manual, Part 2, Taxiways, Aprons and Holding Bays.

[Issue: ADR-DSN/4]

## CS ADR-DSN.D.325 Grading of taxiway strips

*ED Decision 2017/021/R*

- (a) The safety objective of the grading of a taxiway strip is to reduce the risk of damage to an aircraft accidentally running off the taxiway.
- (b) The centre portion of a taxiway strip should provide a graded area to a distance from the centre line of the taxiway of not less than that given by the following tabulation:
  - (1) 10.25 m where the OMGWS is up to but not including 4.5 m;
  - (2) 11 m where the OMGWS is 4.5 m up to but not including 6 m;
  - (3) 12.50 m where the OMGWS is 6 m up to but not including 9 m;
  - (4) 18.50 m where the OMGWS is 9 m up to but not including 15 m, where the code letter is D;
  - (5) 19 m where the OMGWS is 9 m up to but not including 15 m, where the code letter is E;
  - (6) 22 m where the OMGWS is 9 m up to but not including 15 m, where the code letter is F.

[Issue: ADR-DSN/4]

## GM1 ADR-DSN.D.325 Grading of taxiway strips

*ED Decision 2017/021/R*

Further guidance on the width of the graded portion of a taxiway is given in ICAO Doc 9157, Aerodrome Design Manual, Part 2, Taxiways, Aprons and Holding Bays.

[Issue: ADR-DSN/4]

## CS ADR-DSN.D.330 Slopes on taxiway strips

*ED Decision 2014/013/R*

- (a) The safety objective of limiting the longitudinal taxiway strip slopes and slope changes and of minimum sight distances values is to reduce the probability of damage to an aircraft accidentally running off the taxiway and to enable safe use of these areas by rescue and firefighting vehicles.
- (b) The surface of the strip should be flush at the edge of the taxiway or shoulder if provided, and the graded portion should not have an upward transverse slope exceeding:
  - (1) 2.5 % for strips where the code letter is C, D, E, or F; and
  - (2) 3 % for strips of taxiways where the code letter is A or B;the upward slope being measured with reference to the transverse slope of the adjacent taxiway surface and not the horizontal. The downward transverse slope should not exceed 5 % measured with reference to the horizontal.
- (c) The transverse slopes on any portion of a taxiway strip beyond that to be graded should not exceed an upward or downward slope of 5 % as measured in the direction away from the taxiway.

## GM1 ADR-DSN.D.330 Slopes on taxiway strips

*ED Decision 2017/021/R*

- (a) Where required for proper drainage, an open-air storm water conveyance may be allowed in the non-graded portion of a taxiway strip and should be placed as far as practicable from the taxiway.
- (b) The locations of open-air storm water conveyances within the non-graded portion of a taxiway strip should be so designed to permit unobstructed access for rescue and firefighting services (RFFS).

[Issue: ADR-DSN/4]

## CS ADR-DSN.D.335 Holding bays, runway-holding positions, intermediate holding positions, and road-holding positions

*ED Decision 2016/027/R*

- (a) Holding bay(s) or other bypasses of sufficient size and adequate construction should be provided where necessary, to make deviations in the departure sequence possible.
- (b) A runway-holding position or positions should be established:
  - (1) on the taxiway, if the location or alignment of the taxiway is such that a taxiing aircraft or vehicle can infringe an obstacle limitation surface or ILS/MLS critical/sensitive area or interfere with the operation of radio navigation aids;
  - (2) on the taxiway, at the intersection of a taxiway and a runway; and
  - (3) at an intersection of a runway with another runway when the former runway is part of a standard taxi-route.
- (c) An intermediate holding position should be established on a taxiway at any point other than a runway-holding position where it is desirable to define a specific holding limit.
- (d) An emergency access road should be equipped with road-holding positions at all intersections with runways and taxiways.
- (e) A road-holding position should be established at each intersection of a road with a runway.

[Issue: ADR-DSN/3]

## GM1 ADR-DSN.D.335 Holding bays, runway-holding positions, intermediate holding positions, and road-holding positions

*ED Decision 2016/027/R*

- (a) At low levels of aerodrome activity (less than approximately 50 000 annual operations), there is normally little need to make deviations in the departure sequence. However, for higher activity levels, aerodromes with single taxiways and no holding bays or other bypasses provide aerodrome control units with no opportunity to change the sequence of departures once the aircraft have left the apron. In particular, at aerodromes with large apron areas, it is often difficult to arrange for aircraft to leave the apron in such a way that they should arrive at the end of the runway in the sequence required by air traffic services units.
- (b) The provision of an adequate number of holding bay spaces or other bypasses, based upon an analysis of the current and near-term hourly aircraft departure demand, should allow a large degree of flexibility in generating the departure sequence.

- (c) The space required for a holding bay depends on the number of aircraft positions to be provided, the size of the aircraft to be accommodated, and the frequency of their utilisation. The dimensions should allow for sufficient space between aircraft to enable them to manoeuvre independently.
- (d) Emergency access roads are not intended for use for the functions of aerodrome service roads. However, they should be provided by different access controls which should be clearly visible for all service ground traffic.
- (e) Further guidance is given in ICAO Doc 9157, Aerodrome Design Manual, Part 2, Taxiways, Aprons and Holding Bays and ICAO Doc 4444, Procedures for Air Navigation Services — Air Traffic Management.

[Issue: ADR-DSN/3]

## CS ADR-DSN.D.340 Location of holding bays, runway-holding positions, intermediate holding positions, and road-holding positions

*ED Decision 2016/027/R*

- (a) The distance between a holding bay, runway-holding position established at a taxiway/runway intersection or road-holding position and the centre line of a runway should be in accordance with Table D-2 and such that a holding aircraft or vehicle should not interfere with the operation of radio navigation aids.
- (b) At elevations greater than 700 m the distance of 90 m specified in Table D-2 for a precision approach runway code number 4 should be increased as follows:
  - (1) up to an elevation of 2 000 m; 1 m for every 100 m in excess of 700 m;
  - (2) elevation in excess of 2 000 m and up to 4 000 m; 13 m plus 1.5 m for every 100 m in excess of 2 000 m; and
  - (3) elevation in excess of 4 000 m and up to 5 000 m; 43 m plus 2 m for every 100 m in excess of 4 000 m.
- (c) The location of a runway-holding position established in accordance with [CS ADR-DSN.D.335](#) should be such that a holding aircraft or vehicle will not infringe the obstacle-free zone, approach surface, take-off climb surface or ILS/MLS critical/sensitive area or interfere with the operation of radio navigation aids.

Type of runway	Code number <sup>d</sup>			
	1	2	3	4
Non-instrument	30 m	40 m	75 m	75 m
Non-precision approach	40 m	40 m	75 m	75 m
Precision approach Category I	60 m <sup>b</sup>	60 m <sup>b</sup>	90 m <sup>a,b</sup>	90 m <sup>a,b,c</sup>
Precision approach Categories II and III	—	—	90 m <sup>a,b</sup>	90 m <sup>a,b,c</sup>
Take-off runway	30 m	40 m	75 m	75 m

a. If a holding bay, runway-holding position, or road-holding position is at a lower elevation compared to the threshold, the distance may be decreased 5 m for every metre the bay or holding position is lower than the threshold, contingent upon not infringing the inner transitional surface.

- b. This distance may need to be increased to avoid interference with radio navigation aids, particularly the glide path and localiser facilities (see [CS ADR-DSN.D.340](#)).

*Note 1: The distance of 90 m for code number 3 or 4 is based on an aircraft with a tail height of 20 m, a distance from the nose to the highest part of the tail of 52.7 m and a nose height of 10 m holding at an angle of 45° or more with respect to the runway centre line, being clear of the obstacle-free zone and not accountable for the calculation of OCA/H.*

*Note 2: The distance of 60 m for code number 2 is based on an aircraft with a tail height of 8 m, a distance from the nose to the highest part of the tail of 24.6 m and a nose height of 5.2 m holding at an angle of 45° or more with respect to the runway centre line, being clear of the obstacle-free zone.*

- c. Where the code letter is F, this distance should be 107.5 m.

*Note: The distance of 107.5 m for code number 4 where the code letter is F is based on an aircraft with a tail height of 24 m, a distance from the nose to the highest part of the tail of 62.2 m and a nose height of 10 m holding at an angle of 45° or more with respect to the runway centre line, being clear of the obstacle-free zone.*

- d. Elevation of taxiway should be taken into account for possible increase of the distances indicated in this table.

**Table D-2. Minimum distance from the runway centre line to a holding bay, runway-holding position, or road-holding position**

[Issue: ADR-DSN/3]

## GM1 ADR-DSN.D.340 Location of holding bays, runway-holding positions, intermediate holding positions, and road-holding positions

ED Decision 2016/027/R

- (a) Care should be taken so that propeller wash and jet blast from holding aircraft do not interfere with aircraft operations, cause damage to vehicles, or injure people.
- (b) Generally, when used to allow flexible departure sequencing, the most advantageous location for a holding bay is adjacent to the taxiway serving the runway end. Other locations along the taxiway are satisfactory for aircraft performing pre-flight checks or engine run-ups, or as a holding point for aircraft awaiting departure clearance.
- (c) An aircraft taxiing could endanger aircraft operations when the aircraft is too close to the runway during take-off and landings. It is so advised to check if the aircraft taking off or landing could be hindered. For this OLS and specially approach surfaces, take-off climb surfaces and OFZ are the first aspects to consider. An aircraft taxiing could also endanger aircraft operations when the aircraft location and orientation are so that the aircraft interfere with navigation aids. It is specific to instrument runways and especially important for precision approach runways. The non-penetration of critical/sensitive areas is the first check. The areas within which this degradable interference of course or path signals are possible need to be defined and recognised. For the purposes of developing protective zoning criteria for ILS, these areas are critical areas and sensitive areas. The ILS critical area is an area of defined dimensions about the localiser and glide path antennas where vehicles, including aircraft, are excluded during all ILS operations. The critical area is protected, since the presence of vehicles and/or aircraft inside the critical area boundaries would cause unacceptable disturbance to the ILS signal. The ILS sensitive area is an area extending beyond the critical area where the parking and/or movement of vehicles, including aircraft, is controlled to prevent the possibility of unacceptable interference to the ILS signal during ILS operations.



- (d) For all runways, it should be verified that the distance between a holding bay, runway-holding position established at a taxiway/runway intersection or road-holding position and the centre line of a runway is so that a holding aircraft or vehicle should not infringe the approach surface and/or take-off climb surface.
- (e) If the affected runway is used under precision approach procedures, it should be also verified that the distance between a holding bay, runway-holding position established at a taxiway/runway intersection or road-holding position and the centre line of a runway is so that a holding aircraft or vehicle should not infringe the obstacle-free zone and the critical/sensitive areas of precision approach navigation aids (e.g. ILS/MLS).
- (f) If a holding bay, runway-holding position or road-holding position for a precision approach runway code number 4 is at a greater elevation compared to the threshold, the distance of 90 m or 107.5 m, as appropriate, specified in Table D-2 could be further increased 5 m for every metre the bay or position is higher than the threshold.
- (g) An aircraft taxiing could also endanger aircraft operation when the aircraft is too close to other taxiing aircraft. For this, separation distances or margins between taxiing aircraft or taxiways should be considered.
- (h) In radiotelephony phraseologies, the expression 'holding point' is used to designate the runway-holding position.
- (i) Further guidance is given in ICAO Doc 9157, Aerodrome Design Manual, Part 2, Taxiways, Aprons and Holding Bays.

[Issue: ADR-DSN/3]

## CHAPTER E — APRONS

### CS ADR-DSN.E.345 General

*ED Decision 2014/013/R*

Aprons should be provided to permit the safe loading and off-loading of passengers, cargo, or mail as well as the servicing of aircraft without interfering with the aerodrome traffic.

### GM1 ADR-DSN.E.345 General

*ED Decision 2014/013/R*

intentionally left blank

### CS ADR-DSN.E.350 Size of aprons

*ED Decision 2014/013/R*

intentionally left blank

### GM1 ADR-DSN.E.350 Size of aprons

*ED Decision 2016/027/R*

- (a) The total apron area should be adequate to permit safe and expeditious handling of aerodrome traffic at its maximum anticipated density.
- (b) The amount of area required for a particular apron layout depends upon the following factors:
  - (1) the size and manoeuvrability characteristics of the aircraft using the apron;
  - (2) the volume of traffic using the apron;
  - (3) clearance requirements;
  - (4) type of ingress and egress to the aircraft stand;
  - (5) basic terminal layout or other aerodrome use;
  - (6) aircraft ground activity requirements; and
  - (7) taxiways and apron service roads.
- (c) Passenger aircraft services that are carried out during the time the aircraft is parked in a stand position include: galley; toilet and potable water service; baggage handling; fuelling; provision of air conditioning, oxygen, electrical power supply and starting air; and aircraft towing. Most of these functions have a vehicle and/or equipment associated with them, or have some type of fixed installation established to conduct these services. Further guidance is given in ICAO Doc 9157, Aerodrome Design Manual, Part 2, Taxiways, Aprons and Holding Bays, paragraph 3.4.6.
- (d) Consideration should be given to providing sufficient area on the starboard side of the aircraft to support the level of activity that take place in the turnaround operation. Further guidance is given in ICAO Doc 9157, Aerodrome Design Manual, Part 2, Taxiways, Aprons and Holding Bays, paragraph 3.4.6.

[Issue: ADR-DSN/3]

## CS ADR-DSN.E.355 Strength of aprons

ED Decision 2014/013/R

Each part of an apron should be capable of withstanding the traffic of the aircraft it is intended to serve, due consideration being given to the fact that some portions of the apron should be subjected to a higher density of traffic and, as a result of slow moving or stationary aircraft, to higher stresses than a runway.

## GM1 ADR-DSN.E.355 Strength of aprons

ED Decision 2014/013/R

- (a) Apron pavement protection against fuel: On aircraft stands, pavement surface in bituminous concrete and joints between concrete slabs should be protected from fuel effects.
- (b) Fuel on bituminous concrete provokes a disintegration of the concrete which becomes a kind of dark powder. On aircraft stands, it is not rare to have fuel on the pavement surface, due to leakage from aircraft or refuelling devices or due to a wrong move during refuelling. Therefore, if the aircraft stand pavement is in bituminous concrete, a specific protection is considered. Such protection is:
  - (1) a surface protection consisting in an overlay with a material inert against fuel; or
  - (2) a product incorporated in the mass of the bituminous concrete during its fabrication, protecting aggregates and binder.
- (c) The first solution has the disadvantages to be fragile against stamping effects due to aircraft at the stand but is very useful for existing pavement protection.
- (d) Taking into account the stamping due to aircraft at stands and the weakness of bituminous concrete against fuel, the aircraft stand pavements are often in cement concrete, which offers a much better resistance to stamping and to fuel. Nevertheless, joints between cement concrete slabs could be also damaged by fuel. According to the location of such joints regarding aircraft location and refuelling devices location, it is preferable to manufacture such joints in a material resistant to the fuel.

## CS ADR-DSN.E.360 Slopes on aprons

ED Decision 2016/027/R

- (a) Slopes on an apron, including those on an aircraft stand taxilane, should be sufficient to prevent accumulation of water on the surface of the apron but should be kept to the minimum required to facilitate effective drainage.
- (b) On an aircraft stand the maximum slope should not exceed 1 % in any direction.

[Issue: ADR-DSN/3]

## GM1 ADR-DSN.E.360 Slopes on aprons

ED Decision 2016/027/R

- (a) The design of slopes should direct spilled fuel away from building and apron service areas. Where such slopes are unavoidable, special measures should be taken to reduce the fire hazard resulting from fuel spillage.
- (b) Slopes on apron have the same purpose as other pavement slopes, meaning to prevent the accumulation of water (or possible fluid contaminant) on the surface and to facilitate rapid

drainage of surface water (or possible fluid contaminant). Nevertheless, the design of the apron, especially for the parts containing airplane stands, should specifically take into account the impact of the slopes on the airplane during its braking at the stand and during its start for departure (with push-back or with its own engines). The aims are, on the one hand, to avoid that an airplane passes its stop point and goes on the apron service road or to the closest building and on the other hand, to save fuel and optimise the manoeuvrability of the airplane or of the push-back device.

- (c) Where the slope limitation of 1 % on the stands cannot be achieved, the slope should be kept as shallow as possible and should be such that the operation of the aircraft and vehicles is not compromised.

[Issue: ADR-DSN/3]

## CS ADR-DSN.E.365 Clearance distances on aircraft stands

*ED Decision 2016/027/R*

- (a) The safety objective of clearance distances on aircraft stands is to provide safe separation between an aircraft using the stand and any adjacent building, aircraft on another stand and other objects.
- (b) An aircraft stand should provide the following minimum clearances between an aircraft entering or exiting the stand and any adjacent building, aircraft on another stand and other objects:

Code Letter	Clearance
A	3 m
B	3 m
C	4.5 m
D	7.5 m
E	7.5 m
F	7.5 m

- (c) The minimum clearance distance for code letters D, E and F can be reduced:
- (1) for height limited objects,
  - (2) if the stand is restricted for aircraft with specific characteristics,
  - (3) in the following locations (for aircraft using a taxi-in, push-back procedure only):
    - (i) between the terminal (including passenger loading bridges) and the nose of an aircraft; and
    - (ii) over a portion of the stand provided with azimuth guidance by a visual docking guidance system.

[Issue: ADR-DSN/3]

## GM1 ADR-DSN.E.365 Clearance distances on aircraft stands

*ED Decision 2017/021/R*

- (a) Reduced separation at the gate is possible where azimuth guidance by a visual docking guidance system is provided, in combination with additional mitigation measures, such as:
- (1) good condition of marking and signage;

- 
- (2) maintenance of visual docking systems.
  - (b) On aircraft stands, where reduced clearance distances are applied:
    - (1) Guidance by a visual docking guidance system should be provided.
    - (2) All objects for which reduced clearances apply should be properly marked or lighted (see Chapter Q Visual Aids for Denoting Obstacles).
    - (3) Aircraft stands where reduced clearance distances apply should be identified and the information published in the AIP.
    - (4) For code letters D, E or F, an aircraft stand equipped with a visual docking guidance system the minimum clearance of 4.5 metres may be applied between an aircraft entering or exiting the stand and any adjacent building, aircraft on another stand or other objects.
    - (5) For code letter C an aircraft stand equipped with a visual docking guidance system the minimum clearance of 3 metres may be applied between an aircraft entering or exiting the stand and any adjacent building, aircraft on another stand or other objects if a safety assessment indicates that such reduction would not affect the safety of operations of aircraft.
  - (c) Any aircraft passing behind an aircraft parked on an aircraft stand should keep the required clearance distances defined in Table D-1.

[Issue: ADR-DSN/3]

[Issue: ADR-DSN/4]

## CHAPTER F — ISOLATED AIRCRAFT PARKING POSITION

### CS ADR-DSN.F.370 Isolated aircraft parking position

*ED Decision 2014/013/R*

- (a) The safety objective of the isolated aircraft parking position is to provide safe separation between aircraft that need isolation and other aerodrome activities.
- (b) General  
An isolated aircraft parking position should be designated by the aerodrome operator for parking of aircraft that needs isolation from normal aerodrome activities.
- (c) Location  
The isolated aircraft parking position should be located at the maximum distance practicable and in any case never less than 100 m from other parking positions, buildings, or public areas, etc.

### GM1 ADR-DSN.F.370 Isolated aircraft parking position

*ED Decision 2014/013/R*

Care should be taken to ensure that the position is not located over underground utilities, such as gas and aviation fuel and, to the extent feasible, electrical or communication cables. The aerodrome control tower should be advised of an area or areas suitable for the parking of an aircraft.

## CHAPTER G — DE-ICING/ANTI-ICING FACILITIES

### CS ADR-DSN.G.375 General

ED Decision 2014/013/R

Aeroplane de-icing/anti-icing facilities should be provided at an aerodrome where icing conditions are expected to occur.

### GM1 ADR-DSN.G.375 General

ED Decision 2014/013/R

Combinations of ice, snow and/or standing water may, especially when rain, rain and snow, or snow is falling, produce substances with specific gravities in excess of 0.8. These substances, due to their high water/ice content, should have a transparent rather than a cloudy appearance and, at the higher specific gravities, should be readily distinguishable from slush.

### CS ADR-DSN.G.380 Location

ED Decision 2014/013/R

- (a) De-icing/anti-icing facilities should be provided either at aircraft stands or at specified remote areas.
- (b) The de-icing/anti-icing facilities should be located to be clear of the obstacle limitation surfaces to not cause interference to the radio navigation aids and be clearly visible from the air traffic control tower for clearing the treated aeroplane.

### GM1 ADR-DSN.G.380 Location

ED Decision 2016/027/R

- (a) The de-icing/anti-icing facilities should be so located as to ensure that the holdover time of the anti-icing treatment is still in effect at the end of taxiing, and when take-off clearance of the treated aeroplane is given.
- (b) To further maximise departure flow rates for all aeroplanes, the location and size of de-icing/anti-icing facilities should be such that they allow for bypass taxiing during de-icing/anti-icing operations. Additional guidance is given in ICAO Doc 9640, Manual of aircraft ground de-icing/anti-icing operations, paragraph 8.5(e).
- (c) Remote de-icing/anti-icing facilities located near departure runway ends or along taxiways are recommended when taxi times from terminals or off-terminal de-icing/anti-icing locations frequently exceed holdover times.
- (d) Remote facilities compensate for changing weather conditions when icing conditions or blowing snow are expected to occur along the taxi-route taken by the aeroplane to the runway meant for take-off.
- (e) The de-icing/anti-icing facilities should be so located as to provide for an expeditious traffic flow, perhaps with a bypass configuration, and not require unusual taxiing manoeuvre into and out of the pads.
- (f) The jet blast effects caused by a moving aeroplane on other aeroplanes receiving the anti-icing treatment or taxiing behind should have to be taken into account to prevent degradation of the treatment.

[Issue: ADR-DSN/3]

## CS ADR-DSN.G.385 Size of de-icing/anti-icing pads

ED Decision 2014/013/R

- (a) The safety objective of the de-icing/anti-icing pad dimensions is to allow safe positioning of aircraft for de-icing/anti-icing, including sufficient room for the safe movement of de-icing vehicles around the aircraft.
- (b) The size of a de-icing/anti-icing pad should be equal to the parking area required by the most demanding aircraft in a given category with at least 3.8 m clear paved area all around the aeroplane for the movement of the de-icing/anti-icing vehicles.

## GM1 ADR-DSN.G.385 Size of de-icing/anti-icing pads

ED Decision 2016/027/R

- (a) It is recommended that the aerodrome have facilities with a de-icing/anti-icing capability equivalent to the maximum peak hour departure rate that can be managed by the ATC units during de-icing/anti-icing operations. Additional guidance is given in ICAO Doc 9640, Manual of aircraft ground de-icing/anti-icing operations, paragraph 8.3.
- (b) The number of de-icing/anti-icing pads required should be determined based on the meteorological conditions, the type of aeroplanes to be treated, the method of application of de-icing/anti-icing fluid, the type and capacity of the dispensing equipment used, and the volume of traffic and departure flow rates.
- (c) An aeroplane de-icing/anti-icing pad consists of:
  - (1) an inner area for parking of an aeroplane to be treated; and
  - (2) an outer area for movement of two or more mobile de-icing/anti-icing equipment.
- (d) Where more than one de-icing/anti-icing pad is provided, consideration should be given to providing de-icing/anti-icing vehicle movement areas of adjacent pads that do not overlap but are exclusive for each pad. Consideration should also be given to bypassing of the area by other aeroplanes with the clearances specified in [CS ADR-DSN.G.400](#).

[Issue: ADR-DSN/3]

## CS ADR-DSN.G.390 Slopes on de-icing/anti-icing pads

ED Decision 2014/013/R

The de-icing/anti-icing pads should be provided with suitable slopes:

- (a) to ensure satisfactory drainage of the area;
- (b) to permit collection of all excess de-icing/anti-icing fluid running off an aeroplane; and
- (c) not to hinder the movement of aircraft on or off the pad.

## GM1 -ADR-DSN.G.390 Slopes on de-icing/anti-icing pads

ED Decision 2014/013/R

It is recommended that the drainage arrangements for the collection and safe disposal of excess de-icing/anti-icing fluids prevent ground water contamination.



## CS ADR-DSN.G.395 Strength of de-icing/anti-icing pads

ED Decision 2014/013/R

The de-icing/anti-icing pad should be capable of withstanding the traffic of the aircraft it is intended to serve.

## GM1 ADR-DSN.G.395 Strength of de-icing/anti-icing pads

ED Decision 2014/013/R

Consideration should be given to the fact that the de-icing/anti-icing pad (in common with an apron) should be subjected to a higher density of traffic and, as a result of slow-moving or stationary aircraft, to higher stresses than a runway.

## CS ADR-DSN.G.400 Clearance distances on a de-icing/anti-icing pad

ED Decision 2016/027/R

- (a) The safety objective of the clearance distances on a de-icing/anti-icing pad is to provide safe separation between an aircraft using the stand and any adjacent building, aircraft on another stand and other objects.
- (b) A de-icing/anti-icing pad should provide the following minimum clearances between an aircraft using the stand and any adjacent building, aircraft on another stand and other objects:

Code Letter	Clearance
A	3.8 m
B	3.8 m
C	4.5 m
D	7.5 m
E	7.5 m
F	7.5 m

- (c) If the pad layout is such as to include bypass configuration, the minimum separation distances specified in Table D-1, column (13) should be provided.
- (d) Where the de-icing/anti-icing facility is located adjoining a regular taxiway, the taxiway minimum separation distance specified in Table D-1, column (11) should be provided (see Figure G-1).

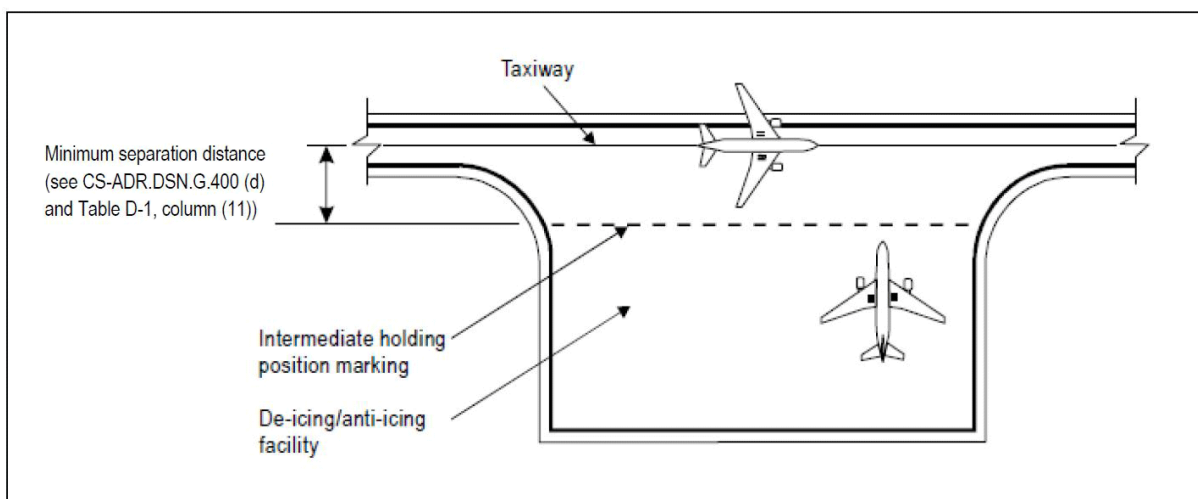


Figure G-1. Minimum separation distance on a de-icing/anti-icing facility

[Issue: ADR-DSN/2]

[Issue: ADR-DSN/3]

## **GM1 ADR-DSN.G.400 Clearance distances on a de-icing/anti-icing pad**

*ED Decision 2014/013/R*

- (a) The separation criteria should take into account the need for individual de-icing/anti-icing pads to provide sufficient manoeuvring area around the airplane to allow simultaneous treatment by two or more mobile de-icing/anti-icing vehicles and sufficient non-overlapping space for a vehicle safety zone between adjacent de-icing pads and for other de-icing/anti-icing pads.
- (b) The minimum clearance distance of 3.8 m is necessary for the movement of de-icing/anti-icing vehicles round the aircraft.
- (c) Where the de-icing/anti-icing facility is located in a non-movement area, the minimum clearance distance can be reduced.

## CHAPTER H — OBSTACLE LIMITATION SURFACES

### CS ADR-DSN.H.405 Applicability

*ED Decision 2014/013/R*

Applicability: The purpose of the obstacle limitation surfaces is to define the airspace around aerodromes to be maintained free from obstacles so as to permit the intended aeroplane operations at the aerodromes to be conducted safely.

### GM1 ADR-DSN.H.405 Applicability

*ED Decision 2021/004/R*

- (a) The obstacle limitation surfaces define the limits to which objects may project into the airspace. Each surface is related to one or more phases of a flight, and provides protection to aircraft during that phase.
- (b) The OLS also help to prevent the aerodromes from becoming unusable by the growth of obstacles around the aerodromes.
- (c) The effective utilisation of an aerodrome may be considerably influenced by natural features and man-made constructions outside its boundary. These may result in limitations on the distance available for take-off and landing and on the range of meteorological conditions in which take-off and landing can be undertaken. For these reasons, certain areas of the local airspace should be regarded as integral parts of the aerodrome environment.
- (d) Objects which penetrate the obstacle limitation surfaces may in certain circumstances cause an increase in the obstacle clearance altitude/height for an instrument approach procedure or any associated visual circling procedure or have other operational impact on flight procedure design. Criteria for flight procedure design are contained in the Procedures for Air Navigation Services — Aircraft Operations (ICAO, PANS-OPS, Doc 8168).
- (e) In ideal circumstances all the surfaces should be free from obstacles but when a surface is infringed, any safety measures required should have regard to:
  - (1) the nature of the obstacle and its location relative to the surface origin, to the extended centre line of the runway or normal approach and departure paths, and to existing obstructions;
  - (2) the amount by which the surface is infringed;
  - (3) the gradient presented by the obstacle to the surface origin;
  - (4) the type of air traffic at the aerodrome; and
  - (5) the instrument approach procedures published for the aerodrome.
- (f) Safety measures could be as follows:
  - (1) promulgation in the AIP of appropriate information;
  - (2) marking and/or lighting of the obstacle;
  - (3) variation of the runway distances declared as available;
  - (4) limitation of the use of the runway to visual approaches only;
  - (5) restrictions on the type of traffic.

- (g) In addition to the requirements described in the certification specifications of Chapter H, it may be necessary to call for other restrictions to development and construction on and in the vicinity of the aerodrome in order to protect the performance of visual and electronic aids to navigation and to ensure that such development does not adversely affect instrument approach procedures and the associated obstacle clearance limits.

[Issue: ADR-DSN/5]

## **CS ADR-DSN.H.410 Outer horizontal surface**

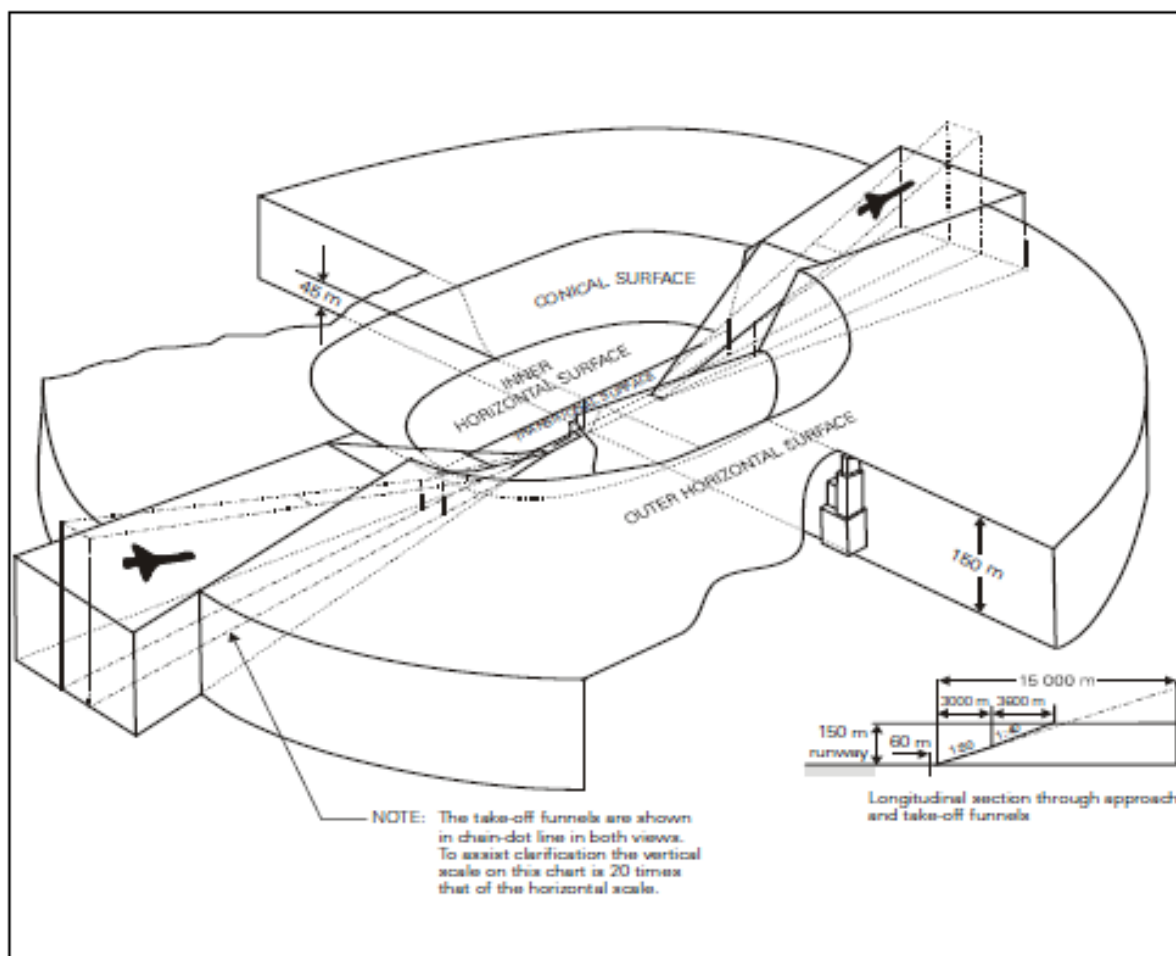
*ED Decision 2014/013/R*

intentionally left blank

## **GM1 ADR-DSN.H.410 Outer horizontal surface**

*ED Decision 2016/027/R*

- (a) The outer horizontal surface should extend from the periphery of the conical surface as shown in Figure GM-H-1. An outer horizontal surface is a specified portion of a horizontal plane around an aerodrome beyond the limits of the conical surface. It represents the level above which consideration needs to be given to the control of new obstacles in order to facilitate practicable and efficient instrument approach procedures, and together with the conical and inner horizontal surfaces to ensure safe visual manoeuvring in the vicinity of an aerodrome.
- (b) The outer horizontal surface is of particular importance for safe operations in areas of high ground or where there are concentrations of obstacles.
- (c) In the experience of some States, operational problems can arise from the erection of tall structures in the vicinity of aerodromes beyond the areas currently recognised in these aerodrome regulations and ICAO Annex 14 as areas in which restriction of new construction may be necessary. Such problems may be addressed through the provision of an outer horizontal surface, which is a specified portion of a horizontal plane around an aerodrome beyond the limits of the conical surface. It represents the level above which consideration needs to be given to the control of new obstacles in order to facilitate practicable and efficient instrument approach procedures, and together with the conical and inner horizontal surfaces to ensure safe visual manoeuvring in the vicinity of an aerodrome.
- (d) As a broad specification for the outer horizontal surface, tall structures can be considered to be of possible significance if they are both higher than 30 m above local ground level, and higher than 150 m above aerodrome elevation within a radius of 15 000 m of the centre of the airport where the runway code number is 3 or 4. The area of concern may need to be extended to coincide with the PANS OPS obstacle areas for the individual approach procedures at the airport under consideration.
- (e) Guidance on Outer Horizontal Surface is included in ICAO Doc 9137, Airport Services Manual, Part 6, Control of Obstacles.



**Figure GM-H-1. Disposition of Outer Horizontal Surface**

[Issue: ADR-DSN/3]

## CS ADR-DSN.H.415 Conical surface

ED Decision 2014/013/R

- (a) Applicability: The purpose of the conical surface is to facilitate safe visual manoeuvring in the vicinity of the aerodrome.
- (b) Description: A surface sloping upwards and outwards from the periphery of the inner horizontal surface.
- (c) Characteristics: The limits of the conical surface should comprise:
  - (1) a lower edge coincident with the periphery of the inner horizontal surface; and
  - (2) an upper edge located at a specified height above the inner horizontal surface.
- (d) The slope of the conical surface should be measured in a vertical plane perpendicular to the periphery of the inner horizontal surface.

## GM1 ADR-DSN.H.415 Conical surface

ED Decision 2014/013/R

intentionally left blank

## CS ADR-DSN.H.420 Inner horizontal surface

ED Decision 2016/027/R

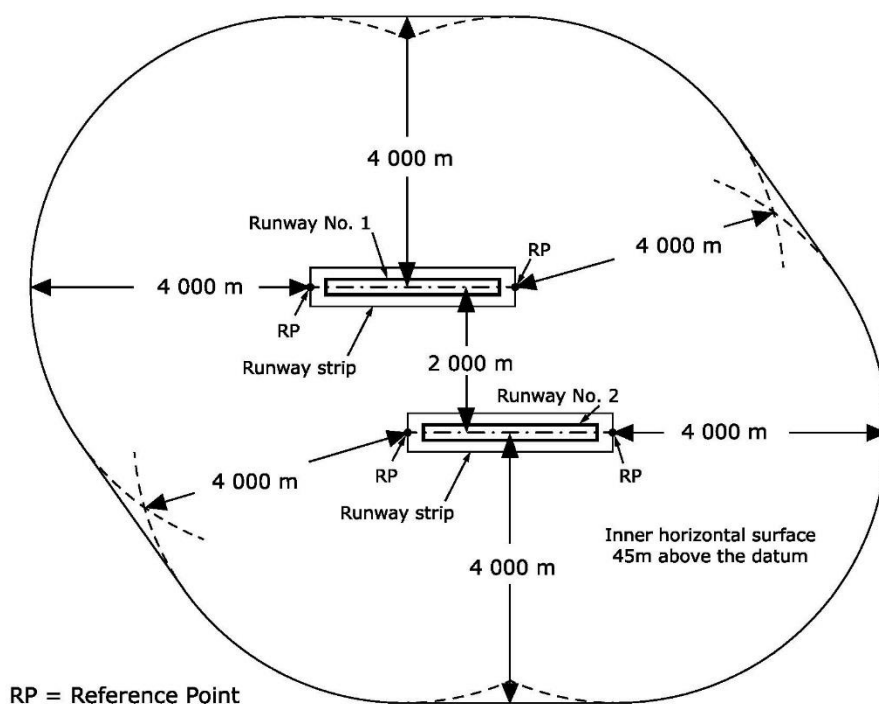
- (a) **Applicability:** The purpose of the inner horizontal surface is to protect airspace for visual manoeuvring prior to landing.
- (b) **Description:** A surface located in a horizontal plane above an aerodrome and its environs.
- (c) **Characteristics:** The outer limits of the inner horizontal surface are defined by a circle centred on the geometric centre of the runway, by a convex contour composed of circular arcs centred on the intersections of the extended RWY centre line with the end of the RWY strip, joined tangentially by straight lines parallel to the runway centre line, as shown in Figure H-1, or on other points established for such purpose.
- (d) The height of the inner horizontal surface should be measured above an established elevation datum. The elevation datum used for the height of the inner horizontal surface should be:
  - (1) the elevation of the highest point of the lowest threshold of the related runway; or
  - (2) the elevation of the highest point of the highest threshold of the related runway; or
  - (3) the elevation of the highest point of the runway; or
  - (4) the aerodrome elevation.

[Issue: ADR-DSN/3]

## GM1 ADR-DSN.H.420 Inner horizontal surface

ED Decision 2016/027/R

- (a) The shape of the inner horizontal surface need not necessarily be circular. Guidance on determining the extent of the inner horizontal surface is contained in the ICAO Doc 9137, Airport Services Manual, Part 6, Control of Obstacles.
- (b) The limits of the inner horizontal surface for longer runways (1 800 m or more in length) are defined as circles of radius 4 000 m centred on the strip ends of the runway. These circles are joined by common tangents parallel to the runway centre line to form a racetrack pattern. The boundary of this pattern is the boundary of the inner horizontal surface.
- (c) For runways less than 1 800 m in length, the inner horizontal surface may be defined as a circle centred on the midpoint of the runway.
- (d) To protect two or more runways, a more complex pattern could become necessary. In this situation, all the circles are joined tangentially by straight lines: illustrated at the Figure GM-H-2.
- (e) For relatively level runways the selection of elevation datum location is not critical, but when the thresholds differ by more than 6 m, the elevation datum should regard to the factors as the elevation of the most frequent used altimeter setting datum points, minimum circling altitudes in use or required and the nature of operations at the aerodrome. For more complex inner horizontal surfaces, with runways on different levels, as shown in Figure GM-H-2, a common elevation is not essential, but where surfaces overlap, the lower surface should be regarded as dominant.
- (f) Further guidance is given in ICAO Doc 9137, Airport Services Manual, Part 6, Control of Obstacles.



**Figure GM-H-2. Composite inner horizontal surface for two parallel runways (where the runway code is 4)**

[Issue: ADR-DSN/3]

## CS ADR-DSN.H.425 Approach surface

ED Decision 2014/013/R

- (a) **Applicability:** The purpose of the approach surface is to protect an aircraft during the final approach to the runway by defining the area that should be kept free from obstacles to protect an aeroplane in the final phase of the approach-to-land manoeuvre.
- (b) **Description:** An inclined plane or combination of planes preceding the threshold.
- (c) **Characteristics.** The limits of the approach surface should comprise:
  - (1) an inner edge of specified length, horizontal and perpendicular to the extended centre line of the runway, and located at a specified distance before the threshold;
  - (2) two sides originating at the ends of the inner edge and diverging uniformly at a specified rate from the extended centre line of the runway; and
  - (3) an outer edge parallel to the inner edge.

The above surfaces should be varied when lateral offset, offset or curved approaches are utilised, specifically, two sides originating at the ends of the inner edge and diverging uniformly at a specified rate from the extended centre line of the lateral offset, offset or curved ground track.

- (d) The elevation of the inner edge should be equal to the elevation of the mid-point of the threshold.

- (e) The slope(s) of the approach surface should be measured in the vertical plane containing the centre line of the runway and should continue containing the centre line of any lateral offset or curved ground track.

## GM1 ADR-DSN.H.425 Approach surface

*ED Decision 2014/013/R*

intentionally left blank

## CS ADR-DSN.H.430 Transitional surface

*ED Decision 2014/013/R*

- (a) **Applicability:** The purpose of the transitional surface is to define the limit of the area available for buildings, other structures or natural obstructions, such as trees.
- (b) **Description:** A complex surface along the side of the strip and part of the side of the approach surface that slopes upwards and outwards to the inner horizontal surface.
- (c) **Characteristics:** The limits of a transitional surface should comprise:
- (1) a lower edge beginning at the intersection of the side of the approach surface with the inner horizontal surface and extending down the side of the approach surface to the inner edge of the approach surface and from there along the length of the strip parallel to the runway centre line; and
  - (2) an upper edge located in the plane of the inner horizontal surface.
- (d) The elevation of a point on the lower edge should be:
- (1) along the side of the approach surface — equal to the elevation of the approach surface at that point; and
  - (2) along the strip — equal to the elevation of the nearest point on the centre line of the runway or its extension.
- (e) The slope of the transitional surface should be measured in a vertical plane at right angles to the centre line of the runway.



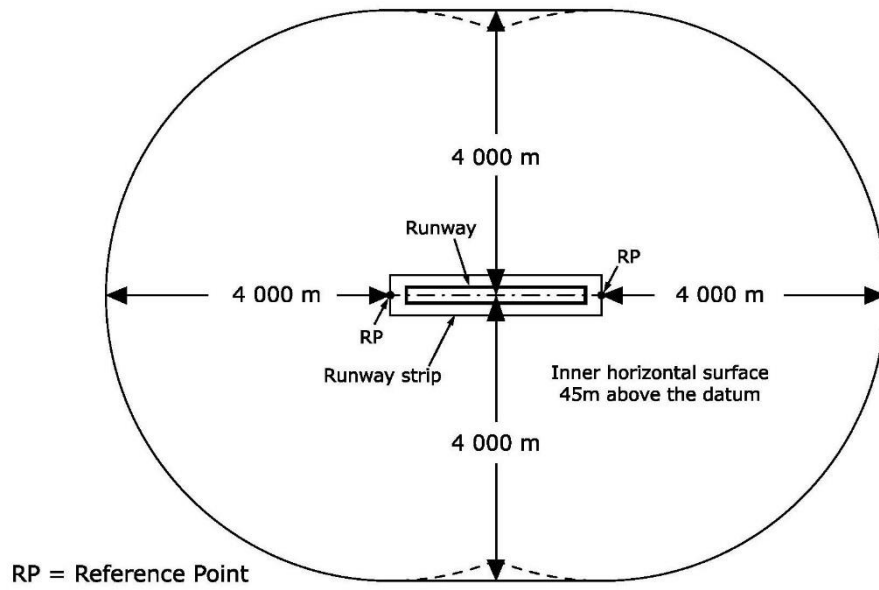
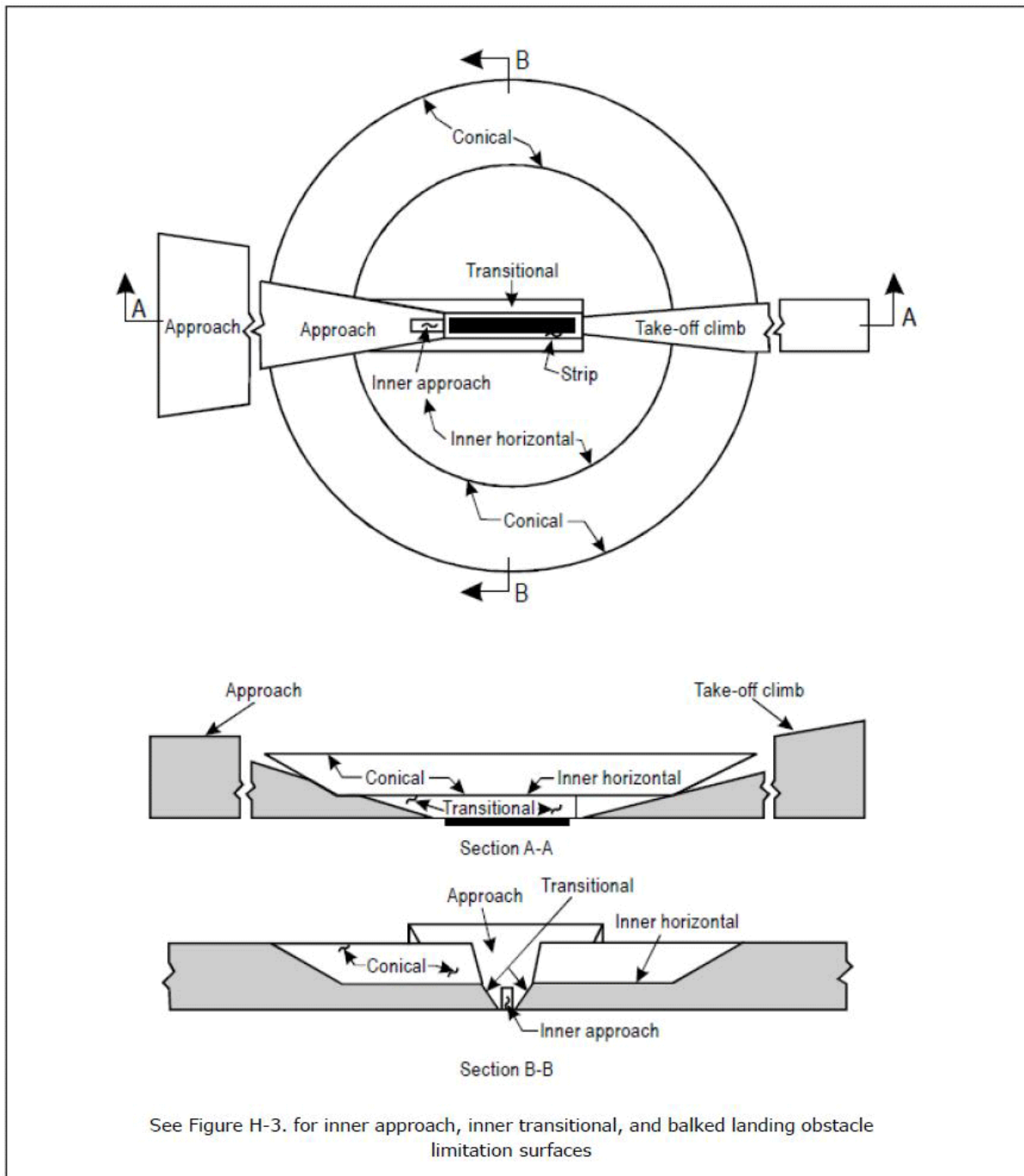
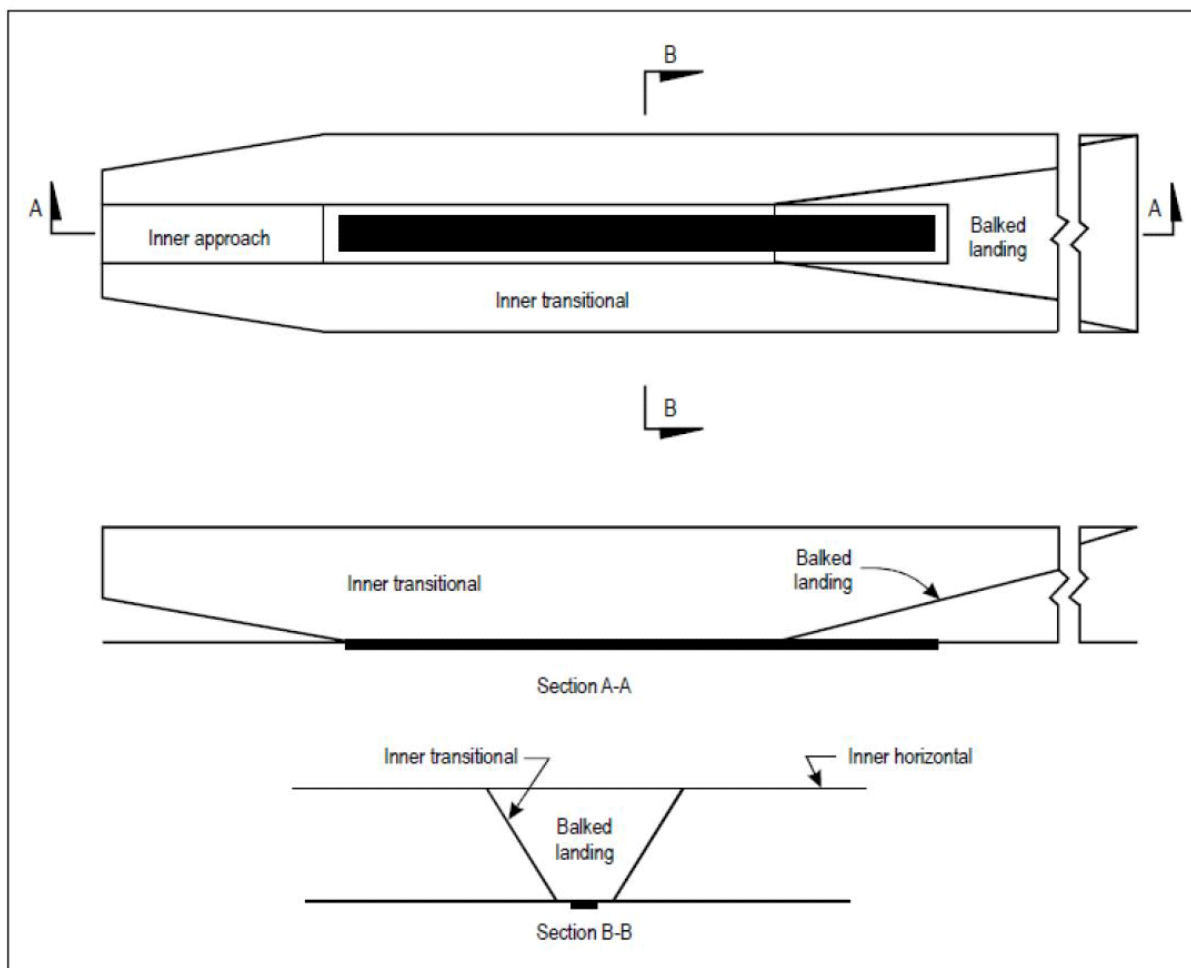


Figure H-1. Inner horizontal surface where the runway is code 4



**Figure H-2. Obstacle limitation surfaces**



**Figure H-3. Inner approach, inner transitional, and balked landing obstacle limitation surfaces**

## GM1 ADR-DSN.H.430 Transitional surface

*ED Decision 2014/013/R*

When the elevation of a point on the lower edge is along the strip and equal to the elevation of the nearest point on the centre line of the runway or its extension as a result the transitional surface along the strip should be curved if the runway profile is curved, or a plane if the runway profile is a straight line. The intersection of the transitional surface with the inner horizontal surface should also be a curved or a straight line depending on the runway profile.

## CS ADR-DSN.H.435 Take-off climb surface

*ED Decision 2014/013/R*

- (a) **Applicability:** The purpose of the take-off climb surface is to protect an aircraft on take-off and during climb-out.
- (b) **Description:** An inclined plane or other specified surface beyond the end of a runway or clearway.
- (c) **Characteristics:** The limits of the take-off climb surface should comprise:
  - (1) an inner edge horizontal and perpendicular to the centre line of the runway, and located either at a specified distance beyond the end of the runway, or at the end of the clearway when such is provided, and its length exceeds the specified distance;

- (2) two sides originating at the ends of the inner edge, diverging uniformly at a specified rate from the take-off track to a specified final width and continuing thereafter at that width for the remainder of the length of the take-off climb surface; and
- (3) an outer edge horizontal and perpendicular to the specified take-off track.
- (d) The elevation of the inner edge should be equal to the highest point on the extended runway centre line between the end of the runway and the inner edge, except that when a clearway is provided, the elevation should be equal to the highest point on the ground on the centre line of the clearway.
- (e) In the case of a straight take-off flight path, the slope of the take-off climb surface should be measured in the vertical plane containing the centre line of the runway.
- (f) In the case of a take-off flight path involving a turn, the take-off climb surface should be a complex surface containing the horizontal normals to its centre line, and the slope of the centre line should be the same as that for a straight take-off flight path.

## GM1 ADR-DSN.H.435 Take-off climb surface

ED Decision 2014/013/R

intentionally left blank

## CS ADR-DSN.H.440 Slewed take-off climb surface

ED Decision 2014/013/R

intentionally left blank

## GM1 ADR-DSN.H.440 Slewed take-off climb surface

ED Decision 2016/027/R

The edge of a Take-off climb surface may be slewed in the direction of a turn away from the extended runway centre line up to a maximum of 15° splay. The portion of take-off climb surface encompassing the new departure track should be the same shape and dimensions as the original take-off climb surface measured relative to the new departure track. The opposite edge of the take-off climb surface should remain unchanged unless there is another turning departure towards that side as well, in which case, the edge may be slewed in that direction too.

[Issue: ADR-DSN/3]

## CS ADR-DSN.H.445 Obstacle-free zone (OFZ)

ED Decision 2016/027/R

- (a) An OFZ is intended to protect aeroplanes from fixed and mobile obstacles during Category II and III operations when approaches are continued below decision height, and during any subsequent missed approach or bailed landing with all engines operating normally. It is not intended to supplant the requirement of other surfaces or areas where these are more demanding.
- (b) The OFZ is made up of the following obstacle limitation surfaces:
  - (1) inner approach surface;
  - (2) inner transitional surfaces; and

- (3) balked landing surface.

[Issue: ADR-DSN/3]

## GM1 ADR-DSN.H.445 Obstacle-free zone (OFZ)

*ED Decision 2016/027/R*

intentionally left blank

[Issue: ADR-DSN/3]

## CS ADR-DSN.H.450 Inner approach surface

*ED Decision 2014/013/R*

- (a) **Applicability:** The purpose of the inner approach surface is to protect final precision approaches.
- (b) **Description:** A rectangular portion of the approach surface immediately preceding the threshold.
- (c) **Characteristics:** The limits of the inner approach surface should comprise:
- (1) an inner edge coincident with the location of the inner edge of the approach surface but of its own specified length;
  - (2) two sides originating at the ends of the inner edge and extending parallel to the vertical plane containing the centre line of the runway; and
  - (3) an outer edge parallel to the inner edge.

## GM1 ADR-DSN.H.450 Inner approach surface

*ED Decision 2014/013/R*

intentionally left blank

## CS ADR-DSN.H.455 Inner transitional surface

*ED Decision 2014/013/R*

- (a) **Applicability:** The purpose of the inner transitional surface is to protect aeroplanes during precision approaches and balked landing.
- (b) **Description:** A surface similar to the transitional surface but closer to the runway.
- (c) **Characteristics:** The limits of an inner transitional surface should comprise:
- (1) a lower edge beginning at the end of the inner approach surface and extending down the side of the inner approach surface to the inner edge of that surface, from there along the strip parallel to the runway centre line to the inner edge of the balked landing surface, and from there up the side of the balked landing surface to the point where the side intersects the inner horizontal surface; and
  - (2) an upper edge located in the plane of the inner horizontal surface.
- (d) **The elevation of a point on the lower edge should be:**
- (1) along the side of the inner approach surface and balked landing surface — equal to the elevation of the particular surface at that point; and

- (2) along the strip — equal to the elevation of the nearest point on the centre line of the runway or its extension.
- (e) The slope of the inner transitional surface should be measured in a vertical plane at right angles to the centre line of the runway.

## GM1 ADR-DSN.H.455 Inner transitional surface

*ED Decision 2014/013/R*

- (a) It is intended that the inner transitional surface be the controlling obstacle limitation surface for navigation aids, aircraft, and other vehicles that should be near the runway, and which is not to be penetrated except for frangible objects. The transitional surface is intended to remain as the controlling obstacle limitation surface for buildings, etc.
- (b) The inner transitional surface along the strip should be curved if the runway profile is curved or a plane if the runway profile is a straight line. The intersection of the inner transitional surface with the inner horizontal surface should also be a curved or straight line depending on the runway profile.

## CS ADR-DSN.H.460 Balked landing surface

*ED Decision 2014/013/R*

- (a) **Applicability:** The purpose of the balked landing surface is to protect balked landing.
- (b) **Description:** An inclined plane located at a specified distance after the threshold, extending between the inner transitional surfaces.
- (c) **Characteristics:** The limits of the balked landing surface should comprise:
  - (1) an inner edge horizontal and perpendicular to the centre line of the runway and located at a specified distance after the threshold;
  - (2) two sides originating at the ends of the inner edge and diverging uniformly at a specified rate from the vertical plane containing the centre line of the runway; and
  - (3) an outer edge parallel to the inner edge and located in the plane of the inner horizontal surface.
- (d) The elevation of the inner edge should be equal to the elevation of the runway centre line at the location of the inner edge.
- (e) The slope of the balked landing surface should be measured in the vertical plane containing the centre line of the runway.

## GM1 ADR-DSN.H.460 Balked landing surface

*ED Decision 2014/013/R*

intentionally left blank

## CHAPTER J — OBSTACLE LIMITATION REQUIREMENTS

### CS ADR-DSN.J.465 General

*ED Decision 2014/013/R*

Obstacle limitation requirements should be distinguished between:

- (a) non-instrument runways;
- (b) non-precision approach runways;
- (c) precision approach runways; and
- (d) runways meant for take-off.

### GM1 ADR-DSN.J.465 General

*ED Decision 2014/013/R*

The requirements for obstacle limitation surfaces are specified on the basis of the intended use of a runway, i.e. take-off or landing, and type of approach, and are intended to be applied when such use of the runway is made. In cases where operations are conducted to or from both directions of a runway, the function of certain surfaces may be nullified because of more stringent requirements of another lower surface.

### CS ADR-DSN.J.470 Non-instrument runways

*ED Decision 2016/027/R*

- (a) The following obstacle limitation surfaces should be established for a non-instrument runway:
  - (1) conical surface;
  - (2) inner horizontal surface;
  - (3) approach surface; and
  - (4) transitional surfaces.
- (b) The heights and slopes of the surfaces should not be greater than, and their other dimensions not less than, those specified in Table J-1.
- (c) New objects or extensions of existing objects should not be permitted above an approach or transitional surface except when the new object or extension would be shielded by an existing immovable object.
- (d) New objects or extensions of existing objects should not be permitted above the conical surface or inner horizontal surface except when the object would be shielded by an existing immovable object, or if after a safety assessment, it is determined that the object would not adversely affect the safety or significantly affect the regularity of operations of aeroplanes.
- (e) Existing objects above any of the conical surface, inner horizontal surface, approach surface and transitional surfaces should, as far as practicable, be removed except when the object is shielded by an existing immovable object, or if after a safety assessment, it is determined that the object would not adversely affect the safety or significantly affect the regularity of operations of aeroplanes.

- (f) In considering proposed construction, account should be taken of the possible future development of an instrument runway and consequent requirement for more stringent obstacle limitation surfaces.

[Issue: ADR-DSN/3]

## GM1 ADR-DSN.J.470 Non-instrument runways

ED Decision 2016/027/R

- (a) Circumstances in which the shielding principle may reasonably be applied are described in the ICAO Doc 9137, Airport Services Manual, Part 6, Control of Obstacles.
- (b) Because of transverse or longitudinal slopes on a strip, in certain cases the inner edge or portions of the inner edge of the approach surface may be below the corresponding elevation of the strip. It is not intended that the strip be graded to conform with the inner edge of the approach surface, nor is it intended that terrain or objects which are above the approach surface beyond the end of the strip, but below the level of the strip, be removed unless it is considered that they may endanger aeroplanes.

[Issue: ADR-DSN/3]

## CS ADR-DSN.J.475 Non-precision approach runways

ED Decision 2016/027/R

- (a) The following obstacle limitation surfaces should be established for a non-precision approach runway:
- (1) conical surface;
  - (2) inner horizontal surface;
  - (3) approach surface; and
  - (4) transitional surfaces.
- (b) The heights and slopes of the surfaces should not be greater than, and their other dimensions not less than, those specified in Table J-1, except in the case of the horizontal section of the approach surface (see paragraph (c) below).
- (c) The approach surface should be horizontal beyond the point at which the 2.5 % slope intersects:
- (1) a horizontal plane 150 m above the threshold elevation; or
  - (2) the horizontal plane passing through the top of any object that governs the obstacle clearance altitude/height (OCA/H);
- whichever is the higher.
- (d) New objects or extensions of existing objects should not be permitted above an approach surface within 3 000 m of the inner edge or above a transitional surface except when the new object or extension would be shielded by an existing immovable object.
- (e) New objects or extensions of existing objects should not be permitted above the approach surface beyond 3 000 m from the inner edge, the conical surface or inner horizontal surface except when the object would be shielded by an existing immovable object, or after a safety assessment, it is determined that the object would not adversely affect the safety or significantly affect the regularity of operations of aeroplanes.



- (f) Existing objects above any of the surfaces required by paragraph (a) should as far as practicable be removed except when the object would be shielded by an existing immovable object, or if after a safety assessment, it is determined that the object would not adversely affect the safety or significantly affect the regularity of operations of aeroplanes.

[Issue: ADR-DSN/3]

## GM1 ADR-DSN.J.475 Non-precision approach runways

*ED Decision 2016/027/R*

- (a) If it is of particular importance for safe operation on circuits, arrival routes towards the aerodrome or on departure or missed approach climb-paths, an outer horizontal surface for non-precision approach runways should be established.
- (b) Circumstances in which the shielding principle may reasonably be applied are described in ICAO Doc 9137, Airport Services Manual, Part 6, Control of Obstacles.
- (c) Because of transverse or longitudinal slopes on a strip, in certain cases the inner edge or portions of the inner edge of the approach surface may be below the corresponding elevation of the strip. It is not intended that the strip be graded to conform with the inner edge of the approach surface, nor is it intended that terrain or objects which are above the approach surface beyond the end of the strip, but below the level of the strip, be removed unless it is considered they may endanger aeroplanes.

[Issue: ADR-DSN/3]

## CS ADR-DSN.J.480 Precision approach runways

*ED Decision 2017/021/R*

- (a) The following obstacle limitation surfaces should be established for a precision approach runway Category I:
- (1) conical surface;
  - (2) inner horizontal surface;
  - (3) approach surface; and
  - (4) transitional surfaces.
- (b) The following obstacle limitation surfaces should be established for a precision approach runway Category II or III:
- (1) conical surface;
  - (2) inner horizontal surface;
  - (3) approach surface and inner approach surface;
  - (4) transitional surfaces and inner transitional surfaces; and
  - (5) balked landing surface.
- (c) The heights and slopes of the surfaces should not be greater than, and their other dimensions not less than, those specified in Table J-1, except in the case of the horizontal section of the approach surface in paragraph (d) below.
- (d) The approach surface should be horizontal beyond the point at which the 2.5 % slope intersects:
- (1) a horizontal plane 150 m above the threshold elevation; or

- (2) the horizontal plane passing through the top of any object that governs the obstacle clearance limit;
- whichever is the higher.
- (e) Fixed objects should not be permitted above the inner approach surface, the inner transitional surface or the balked landing surface, except for frangible objects which because of their function should be located on the strip. Mobile objects should not be permitted above these surfaces during the use of the runway for landing.
- (f) New objects or extensions of existing objects should not be permitted above an approach surface or a transitional surface except when the new object or extension would be shielded by an existing immovable object.
- (g) New objects or extensions of existing objects should not be permitted above the conical surface and the inner horizontal surface except when an object would be shielded by an existing immovable object, or if after a safety assessment, it is determined that the object would not adversely affect the safety or significantly affect the regularity of operations of aeroplanes.
- (h) Existing objects above an approach surface, a transitional surface, the conical surface and inner horizontal surface should, as far as practicable, be removed except when an object would be shielded by an existing immovable object, or if after a safety assessment, it is determined that the object would not adversely affect the safety or significantly affect the regularity of operations of aeroplanes.

APPROACH RUNWAYS										
RUNWAY CLASSIFICATION										
Surface and dimensions <sup>a</sup>	Non-instrument Code number				Non-precision approach Code number			Precision approach category		
	I Code number		II or III Code number							
	1	2	3	4	1, 2	3	4	1, 2	3, 4	3, 4
(1)	(2)	(3)	(4)	(5)	(6)	(7)	(8)	(9)	(10)	(11)
CONICAL										
Slope	5 %	5 %	5 %	5 %	5 %	5 %	5 %	5 %	5 %	5 %
Height	35 m	55 m	75 m	100 m	60 m	75 m	100 m	60 m	100 m	100 m
INNER HORIZONTAL										
Height	45 m	45 m	45 m	45 m	45 m	45 m	45 m	45 m	45 m	45 m
Radius	2 000 m	2 500 m	4 000 m	4 000 m	3 500 m	4 000 m	4 000 m	3 500 m	4 000 m	4 000 m
INNER APPROACH										
Width	-	-	-	-	-	-	-	90 m	120 m <sup>e</sup>	120 m <sup>e</sup>
Distance from threshold	-	-	-	-	-	-	-	60 m	60 m	60 m
Length	-	-	-	-	-	-	-	900 m	900 m	900 m
Slope	-	-	-	-	-	-	-	2.5 %	2 %	2 %

APPROACH RUNWAYS										
RUNWAY CLASSIFICATION										
Surface and dimensions <sup>a</sup>	Non-instrument Code number				Non-precision approach Code number			Precision approach category		
								I Code number	II or III Code number	
	1	2	3	4	1, 2	3	4	1, 2	3, 4	3, 4
(1)	(2)	(3)	(4)	(5)	(6)	(7)	(8)	(9)	(10)	(11)
APPROACH										
Length of inner edge	60 m	80 m	150 m	150 m	140 m	280 m	280 m	140 m	280 m	280 m
Distance from threshold	30 m	60 m	60 m	60 m	60 m	60 m	60 m	60 m	60 m	60 m
Divergence (each side)	10 %	10 %	10 %	10 %	15 %	15 %	15 %	15 %	15 %	15 %
First section										
Length	1 600 m	2 500 m	3 000 m	3 000 m	2 500 m	3 000 m	3 000 m	3 000 m	3 000 m	3 000 m
Slope	5 %	4 %	3.33 %	2.5 %	3.33 %	2 %	2 %	2.5 %	2 %	2 %
Second section										
Length	-	-	-	-	-	3 600 m <sup>b</sup>	3 600 m <sup>b</sup>	12 000 m	3 600 m <sup>b</sup>	3 600 m <sup>b</sup>
Slope	-	-	-	-	-	2.5 %	2.5 %	3 %	2.5 %	2.5 %
Horizontal section										
Length	-	-	-	-	-	8 400 m <sup>b</sup>	8 400 m <sup>b</sup>	-	8 400 m <sup>b</sup>	8 400 m <sup>b</sup>
Total length	-	-	-	-	-	15 000 m	15 000 m	15 000 m	15 000 m	15 000 m
TRANSITIONAL										
Slope	20 %	20 %	14.3 %	14.3 %	20 %	14.3 %	14.3 %	14.3 %	14.3 %	14.3 %
INNER TRANSITIONAL										
Slope	-	-	-	-	-	-	-	40 %	33.3 %	33.3 %
BALKED LANDING SURFACE										
Length of inner edge	-	-	-	-	-	-	-	90 m	120 m <sup>e</sup>	120 m <sup>e</sup>
Distance from threshold	-	-	-	-	-	-	-	c	1 800 m <sup>d</sup>	1 800 m <sup>d</sup>
Divergence (each side)	-	-	-	-	-	-	-	10 %	10 %	10 %
Slope	-	-	-	-	-	-	-	4 %	3.33 %	3.33 %
a.	All dimensions are measured horizontally unless specified otherwise.				e.	Where the code letter is F (Code element 2 of Table A-1), the width is increased to 140 m.				

- |    |                                                                                                 |
|----|-------------------------------------------------------------------------------------------------|
| b. | Variable length ( <a href="#">CS ADR-DSN.J.475(c)</a> or <a href="#">CS ADR-DSN.J.480(d)</a> ). |
| c. | Distance to the end of strip.                                                                   |
| d. | Or end of runway whichever is less.                                                             |

**Table J-1. Dimensions and slopes of obstacle limitation surfaces — Approach runways**

[Issue: ADR-DSN/3]

[Issue: ADR-DSN/4]

## GM1 ADR-DSN.J.480 Precision approach runways

ED Decision 2016/027/R

- (a) The following obstacle limitation surfaces should be established for a precision approach runway Category I:
- (1) inner approach surface;
  - (2) inner transitional surfaces; and
  - (3) balked landing surface.
- (b) See [CS ADR-DSN.T.915](#) for information regarding siting of equipment and installations on operational areas.
- (c) Guidance on obstacle limitation surfaces for precision approach runways is given in ICAO Doc 9137, Airport Services Manual, Part 6, Control of Obstacles.
- (d) Circumstances in which the shielding principle may reasonably be applied are described in ICAO Doc 9137, Airport Services Manual, Part 6, Control of Obstacles.
- (e) Because of transverse or longitudinal slopes on a strip, in certain cases the inner edge or portions of the inner edge of the approach surface may be below the corresponding elevation of the strip. It is not intended that the strip be graded to conform with the inner edge of the approach surface, nor is it intended that terrain or objects which are above the approach surface beyond the end of the strip, but below the level of the strip, be removed unless it is considered that they may endanger aeroplanes.
- (f) For information on code letter F aeroplanes equipped with digital avionics that provide steering commands to maintain an established track during the go-around manoeuvre. Additional guidance is given in ICAO Circular, 301, New Larger Aeroplanes — Infringement of the Obstacle Free Zone.

[Issue: ADR-DSN/3]

## CS ADR-DSN.J.485 Runways meant for take-off

ED Decision 2016/027/R

- (a) The safety objective of the take-off climb surface slopes and dimensions is to allow safe take-off operations by defining the limits above which new obstacles should not be permitted unless shielded by an existing immovable object.
- (b) A take-off climb surface should be established for a runway meant for take-off.
- (c) The dimensions of the surface should be not less than the dimensions specified in Table J-2, except that a lesser length may be adopted for the take-off climb surface where such lesser

length would be consistent with procedural measures adopted to govern the outward flight of aeroplanes.

- (d) New objects or extensions of existing objects should not be permitted above a take-off climb surface except when the new object or extension would be shielded by an existing immovable object.
- (e) Existing objects that extend above a take-off climb surface should as far as practicable be removed except when an object is shielded by an existing immovable object, or if after a safety assessment, it is determined that the object would not adversely affect the safety or significantly affect the regularity of operations of aeroplanes.

RUNWAYS MEANT FOR TAKE-OFF			
Surface and dimensions <sup>a</sup>	Code number		
	1	2	3 or 4
(1)	(2)	(3)	(4)
TAKE-OFF CLIMB			
Length of inner edge	60 <sup>e</sup> m	80 <sup>e</sup> m	180 m
Distance from runway end <sup>b</sup>	30 m	60 m	60 m
Divergence (each side)	10 %	10 %	12.5 %
Final width	380 m	580 m	1 200 m 1 800 m <sup>c</sup>
Length	1 600 m	2 500 m	15 000 m
Slope	5 %	4 %	2 % <sup>d</sup>
a	All dimensions are measured horizontally unless specified otherwise.		
b	The take-off climb surface starts at the end of the clearway if the clearway length exceeds the specified distance.		
c	1 800 m when the intended track includes changes of heading greater than 15° for operations conducted in IMC, VMC by night.		
d	See <a href="#">GM1 ADR-DSN.J.485(a) and (e)</a> .		
e	Where clearway is provided the length of the inner edge should be 150 m.		

**Table J-2. Dimensions and slopes of obstacle limitation surfaces — Runways meant for take-off**

[Issue: ADR-DSN/3]

## GM1 ADR-DSN.J.485 Runways meant for take-off

*ED Decision 2016/027/R*

- (a) If no object reaches the 2 % (1:50) take-off climb surface, an obstacle-free surface of 1.6 % (1:62.5) should be established.
- (b) When local conditions differ widely from sea level standard atmospheric conditions, it may be advisable for the slope specified in Table J-2 to be reduced. The degree of this reduction depends on the divergence between local conditions and sea level standard atmospheric conditions, and on the performance characteristics and operational requirements of the aeroplanes for which the runway is intended.
- (c) Circumstances in which the shielding principle may reasonably be applied are described in ICAO Doc 9137, Airport Services Manual, Part 6, Control of Obstacles.
- (d) Because of transverse slopes on a strip or clearway, in certain cases portions of the inner edge of the take-off climb surface may be below the corresponding elevation of the strip or clearway.

It is not intended that the strip or clearway be graded to conform with the inner edge of the take-off climb surface, nor is it intended that terrain or objects which are above the take-off climb surface beyond the end of the strip or clearway, but below the level of the strip or clearway, be removed unless it is considered that they may endanger aeroplanes. Similar considerations apply at the junction of a clearway and strip where differences in transverse slopes exist.

- (e) The operational characteristics of aeroplanes for which the runway is intended should be examined to see if it is desirable to reduce the slope specified in Table J-2 when critical operating conditions are to be catered to. If the specified slope is reduced, corresponding adjustment in the length of the take-off climb surface should be made so as to provide protection to a height of 300 m.

[Issue: ADR-DSN/3]

## **CS ADR-DSN.J.486 Other objects**

*ED Decision 2016/027/R*

- (a) Objects which do not project through the approach surface but which would nevertheless adversely affect the optimum siting or performance of visual or non-visual aids should, as far as practicable, be removed.
- (b) Anything which may, after a safety assessment, endanger aeroplanes on the movement area or in the air within the limits of the inner horizontal and conical surfaces should be regarded as an obstacle and should be removed in so far as practicable.

[Issue: ADR-DSN/3]

## **GM1 ADR-DSN.J.486 Other objects**

*ED Decision 2016/027/R*

In certain circumstances, objects that do not project above any of the obstacle limitation surfaces may constitute a hazard to aeroplanes as, for example, where there are one or more isolated objects in the vicinity of an aerodrome.

[Issue: ADR-DSN/3]

## **CS ADR-DSN.J.487 Objects outside the obstacle limitation surfaces**

*ED Decision 2016/027/R*

- (a) Applicability: The specifications in paragraph (b) below apply only to the area under control of the aerodrome operator.
- (b) In areas beyond the limits of the obstacle limitation surfaces, at least those objects which extend to a height of 150 m or more above ground elevation should be regarded as obstacles, unless a safety assessment indicates that they do not constitute a hazard to aeroplanes.

[Issue: ADR-DSN/3]

## **GM1 ADR-DSN.J.487 Objects outside the obstacle limitation surfaces**

*ED Decision 2016/027/R*

- (a) Beyond the limits of the obstacle limitation surfaces the safety assessment should be conducted for the proposed constructions that extend above the established limits in order to protect safe operation of aircraft.
- (b) The safety assessment may have regard to the nature of operations concerned and may distinguish between day and night operations.

[Issue: ADR-DSN/3]

## CHAPTER K — VISUAL AIDS FOR NAVIGATION (INDICATORS AND SIGNALLING DEVICES)

### CS ADR-DSN.K.490 Wind direction indicator

ED Decision 2014/013/R

- (a) An aerodrome should be equipped with a sufficient number of wind direction indicators in order to provide wind information to the pilot during approach and take-off.
- (b) Location:  
Each wind direction indicator should be located so that at least one wind direction indicator is visible from aircraft in flight, during approach or on the movement area before take-off, and in such a way as to be free from the effects of air disturbances caused by nearby objects.
- (c) Characteristics:
- (1) Each wind direction indicator should be in the form of a truncated cone made of fabric and should have a length of not less than 3.6 m and a diameter, at the larger end, of not less than 0.9 m.
  - (2) It should be constructed so that it gives a clear indication of the direction of the surface wind and a general indication of the wind speed.
  - (3) The colour or colours should be so selected as to make the wind direction indicator clearly visible and understandable from a height of at least 300 m. Having regard to background:
    - (i) where practicable, a single colour should be used; and
    - (ii) where a combination of two colours is required to give adequate conspicuity against changing backgrounds, they should preferably be orange and white, red and white, or black and white, and should be arranged in five alternate bands, the first and last bands being the darker colour.
- (d) Night conditions:  
Provision should be made for illuminating a sufficient number of wind indicators at an aerodrome intended for use at night.

### GM1 ADR-DSN.K.490 Wind direction indicator

ED Decision 2016/027/R

- (a) Wind direction indicators are important visual aids for all runway ends. Large wind direction indicators are particularly important at aerodromes where landing information is not available through radio communications. On the other hand, landing direction indicators are seldom used due to the necessity and, consequently, responsibility, of changing their direction as wind direction shifts. Visual ground signals for runway and taxiway serviceability are contained in ICAO Annex 2. Additional guidance is given in ICAO Doc 9157, Aerodrome Design Manual, Part 4, Visual Aids, Chapter 3.
- (b) A fabric wind cone is generally the type preferred by pilots because it provides a general indication of wind speed. Cones that extend fully at wind speeds of about 15 kt are most useful since this is the maximum crosswind landing component for small aircraft.



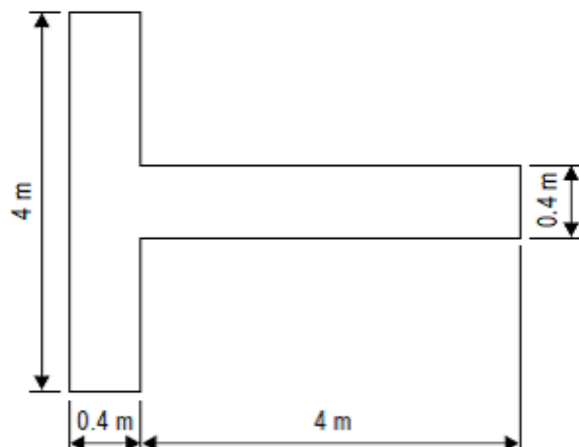
- (c) It may be possible to improve the perception by the pilot of the location of the wind direction indicator by several means notably by circular marking around this indicator. The location of at least one wind direction indicator should be marked by a circular band 15 m in diameter and 1.2 m wide. The band should be centred about the wind direction indicator support, and should be in a colour chosen to give adequate conspicuity, preferably white.
- (d) The usefulness of any visual aid is determined largely by its size, conspicuity, and location. Given conditions of good atmospheric visibility, the maximum distance at which the information available from an illuminated wind sleeve can be usefully interpreted is 1 km. Thus, in order that a pilot may make use of this information whilst on approach, the wind sleeve should be sited no farther from the runway threshold than 600 m. Obstacle criteria excluded, the ideal location is 300 m along the runway from the threshold and laterally displaced at 80 m from the runway centre line.
- (e) This means, in effect, that only those aerodromes where the thresholds are less than 1 200 m apart can meet the minimum requirement with a single unit. Most code 3 and 4 aerodromes should require two or more units suitably sited in order to provide the best possible coverage.
- (f) The final choice of unit numbers and location should depend on a number of factors which should vary from aerodrome to aerodrome. However, when deciding on the most appropriate location, account should be taken to ensure that the wind direction indicator is:
  - (1) outside the Cleared and Graded Area of the runway and taxiway strips;
  - (2) clear of the OFZ and ILS critical/sensitive areas where appropriate;
  - (3) preferably not more than 200 m lateral displacement from the runway edge;
  - (4) preferably between 300 m and 600 m from the runway threshold measured along the runway;
  - (5) in an area with low background levels of illumination;
  - (6) visible from the approach and take-off positions of all runways; and
  - (7) free from the effects of air disturbance caused by nearby objects.

[Issue: ADR-DSN/3]

## **CS ADR-DSN.K.495 Landing direction indicator**

*ED Decision 2014/013/R*

- (a) Location: Where provided, a landing direction indicator should be located in a conspicuous place on the aerodrome.
- (b) Characteristics:
  - (1) The landing direction indicator should be in the form of a 'T'.
  - (2) The shape and minimum dimensions of a landing 'T' should be as shown in Figure K-1.
  - (3) The colour of the landing 'T' should be either white or orange, the choice being dependent on the colour that contrasts best with the background against which the indicator should be viewed.
  - (4) Where used at night, the landing 'T' should either be illuminated or outlined by white lights.



**Figure K-1. Landing direction indicator**

## GM1 ADR-DSN.K.495 Landing direction indicator

*ED Decision 2014/013/R*

The landing 'T' may be constructed of wood or other light material and its dimensions may correspond to those shown in Figure K-1. It may be painted white or orange. The landing 'T' should be mounted on a cement concrete pedestal adequately reinforced with steel bars to avoid cracks resulting from unequal settlement. The surface of the pedestal should be finished smooth with a steel trowel and coated with paint of appropriate colour. The colour of the pedestal should be chosen to contrast with the colour of the landing 'T'. Before fastening the landing 'T' base to the concrete pedestal, the mounting bolts should be checked for correct spacing. The landing 'T' should be assembled and mounted in accordance with the manufacturer's installation instructions. It should be free to move about a vertical axis so that it can be set in any direction. Where required for use at night, the landing 'T' should either be illuminated or outlined by white lights.

## CS ADR-DSN.K.500 Signalling lamp

*ED Decision 2014/013/R*

- (a) A signalling lamp should be provided at a controlled aerodrome in the aerodrome control tower.
- (b) Characteristics:
  - (1) A signalling lamp should be capable of producing red, green and white signals, and of:
    - (i) being aimed manually at any target as required; and
    - (ii) giving a signal in any one colour followed by a signal in either of the two other colours.
  - (2) The beam spread should be not less than 1° or greater than 3°, with negligible light beyond 3°. When the signalling lamp is intended for use in the daytime, the intensity of the coloured light should be not less than 6 000 cd.

## GM1 ADR-DSN.K.500 Signalling lamp

ED Decision 2014/013/R

When selecting the green light, use should be made of the restricted boundary of green as specified in [GM1 ADR-DSN.U.930\(a\)](#).

## CS ADR-DSN.K.505 Signal panels and signal area

ED Decision 2014/013/R

intentionally left blank

## GM1 ADR-DSN.K.505 Signal panels and signal area

ED Decision 2014/013/R

- (a) A signal panels and signal area should be provided when visual ground signals are used to communicate with aircraft in flight.
- (b) A signal panel and signal area may be needed when the aerodrome does not have an aerodrome control tower or an aerodrome flight information service unit, or when the aerodrome is used by aeroplanes not equipped with radio. Visual ground signals may also be useful in the case of failure of two-way radio communication with aircraft. It should be recognised, however, that the type of information which may be conveyed by visual ground signals should normally be available in AIP or NOTAM. The potential need for visual ground signals should, therefore, be evaluated before deciding to provide a signal area.
- (c) ICAO Annex 2, Appendix 1, specifies the shape, colour and use of visual ground signals.

## CS ADR-DSN.K.510 Location of signal panels and signal area

ED Decision 2014/013/R

intentionally left blank

## GM1 ADR-DSN.K.510 Location of signal panels and signal area

ED Decision 2014/013/R

A signal area should be located so as to be visible for all angles of azimuth above an angle of 10° above the horizontal when viewed from a height of 300 m.

## CS ADR-DSN.K.515 Characteristics of signal panels and signal area

ED Decision 2014/013/R

intentionally left blank

## GM1 ADR-DSN.K.515 Characteristics of signal panels and signal area

ED Decision 2016/027/R

- (a) The signal area should be an even horizontal surface at least 9 m square.
- (b) The signal area should be constructed of cement concrete reinforced with an adequate quantity of steel to avoid cracks resulting from unequal settlement. The top surface should be finished smooth with a steel trowel and coated with paint of appropriate colour. The colour of the signal area should be chosen to contrast with the colours of the signal panels to be displayed thereon.

More guidance is given in ICAO Doc 9157, Aerodrome Design Manual Part 4, Visual Aids, Chapter 3.

- (c) The colour of the signal area should be chosen to contrast with the colours of the signal panels used, and it should be surrounded by a white border not less than 0.3 m wide.

[Issue: ADR-DSN/3]

## CHAPTER L — VISUAL AIDS FOR NAVIGATION (MARKINGS)

### CS ADR-DSN.L.520 General — Colour and conspicuity

*ED Decision 2014/013/R*

Markings should be of a conspicuous colour and contrast with the surface on which they are laid.

- (a) Runway markings should be white.
- (b) Markings for taxiways, runway turn pads, and aircraft stands should be yellow.
- (c) Apron safety lines should be of a conspicuous colour which should contrast with that used for aircraft stand markings.
- (d) When it is operationally necessary to apply temporary runway or taxiway markings, those markings should comply with the relevant CS.

### GM1 ADR-DSN.L.520 General – Colour and conspicuity

*ED Decision 2016/027/R*

- (a) Where there is insufficient contrast between the marking and the pavement surface, the marking should include an appropriate border.
  - (1) This border should be white or black;
  - (2) It is preferable that the risk of uneven friction characteristics on markings be reduced in so far as practicable by the use of a suitable kind of paint; and
  - (3) Markings should consist of solid areas or a series of longitudinal stripes providing an effect equivalent to the solid areas.
  - (4) Guidance on reflective materials is given in the ICAO Doc 9157, Aerodrome Design Manual, Part 4, Visual Aids.
- (b) At aerodromes where operations take place at night, pavement markings should be made with reflective materials designed to enhance the visibility of the markings.

[Issue: ADR-DSN/3]

### CS ADR-DSN.L.525 Runway designation marking

*ED Decision 2016/027/R*

- (a) Applicability: A runway designation marking should be provided at the thresholds of a runway.
- (b) Location and positioning: A runway designation marking should be located at a threshold as shown in Figure L-1 as appropriate.
- (c) Characteristics:
  - (1) A runway designation marking should consist of a two-digit number and on parallel runways should be supplemented with a letter.
    - (i) On a single runway, dual parallel runways and triple parallel runways, the two-digit number should be the whole number nearest the one-tenth of the magnetic North when viewed from the direction of approach.
    - (ii) On four or more parallel runways, one set of adjacent runways should be numbered to the nearest one-tenth magnetic azimuth and the other set of

adjacent runways numbered to the next nearest one-tenth of the magnetic azimuth.

- (iii) When a runway designation marking consists of a single digit number, it should be preceded by a zero.
- (2) In the case of parallel runways, each runway designation number should be supplemented by a letter as follows, in the order shown from left to right when viewed from the direction of approach:
  - (i) for two parallel runways: 'L' 'R';
  - (ii) for three parallel runways: 'L' 'C' 'R';
  - (iii) for four parallel runways: 'L' 'R' 'L' 'R';
  - (iv) for five parallel runways: 'L' 'C' 'R' 'L' 'R' or 'L' 'R' 'L' 'C' 'R'; and
  - (v) for six parallel runways: 'L' 'C' 'R' 'L' 'C' 'R'.
- (3) The numbers and letters should be in the form and proportion shown in Figure L-2. The dimensions should be not less than those shown in Figure L-2. Where the numbers are incorporated in the threshold marking, larger dimensions should be used in order to fill adequately the gap between the stripes of the threshold marking.

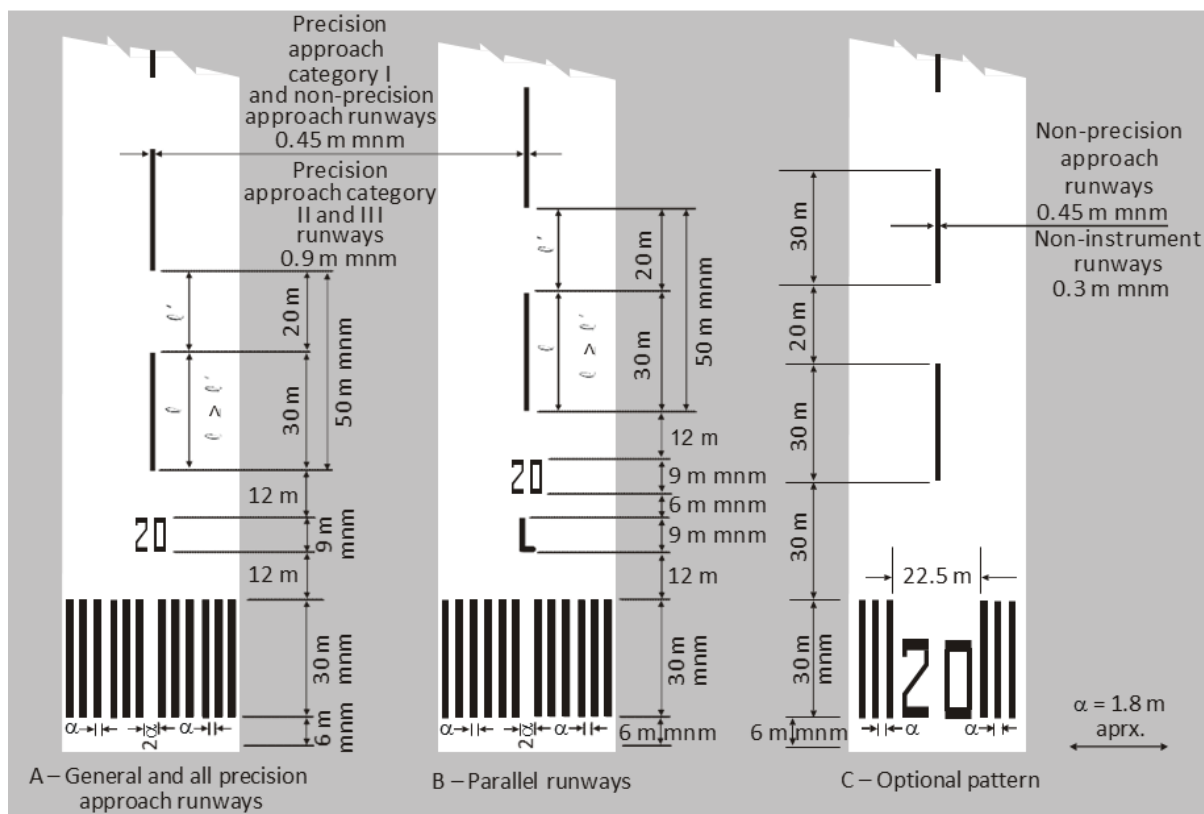


Figure L-1. Runway designation, centre line and threshold markings

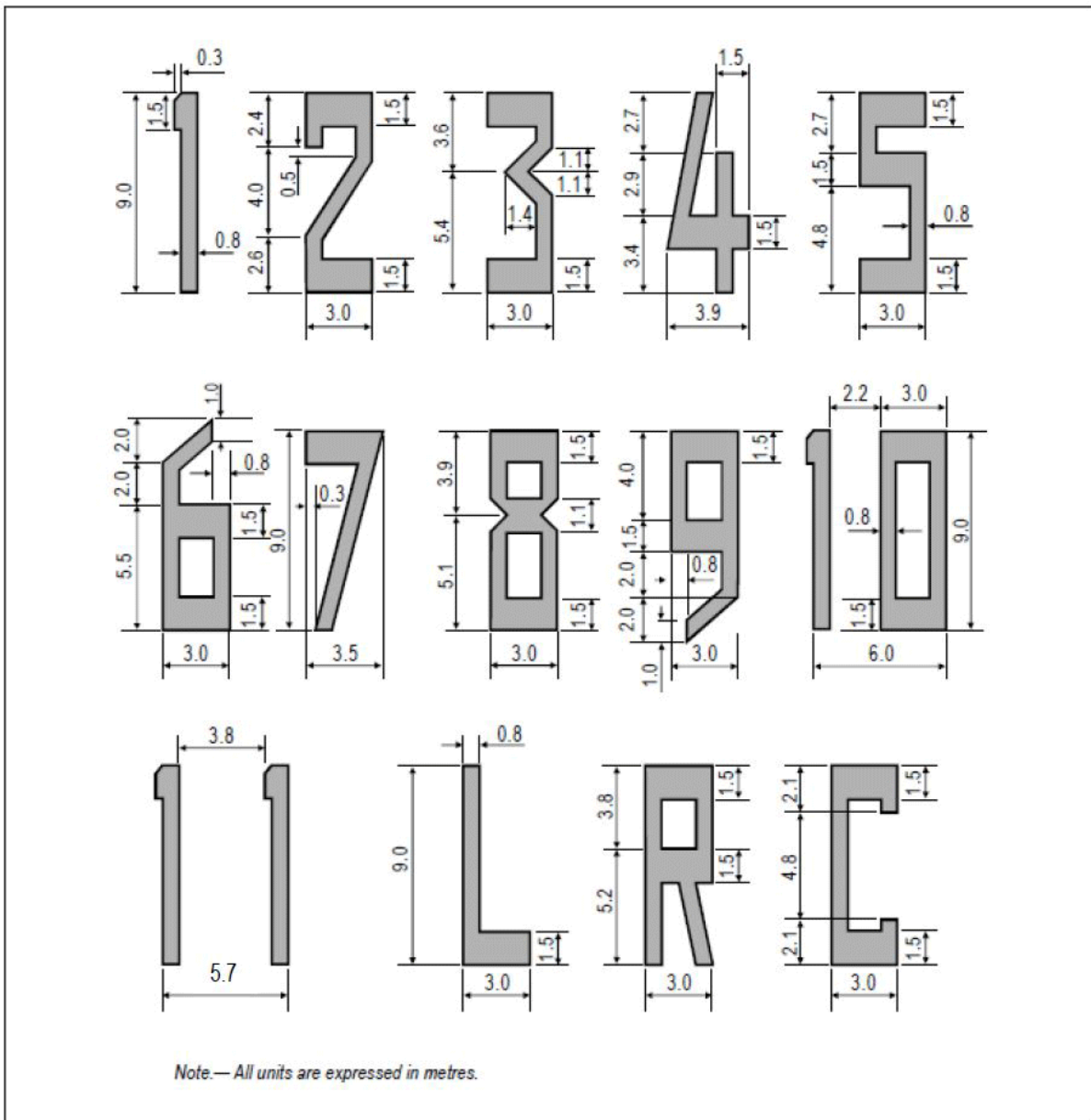


Figure L-2. Form and proportions of numbers and letters for runway designation markings

[Issue: ADR-DSN/3]

## GM1 ADR-DSN.L.525 Runway designation marking

ED Decision 2014/013/R

intentionally left blank

## CS ADR-DSN.L.530 Runway centre line marking

ED Decision 2016/027/R

- (a) Applicability: A runway centre line marking should be provided on a paved runway.
- (b) Location: A runway centre line marking should be located along the centre line of the runway between the runway designation marking as shown in Figure L-1, except when interrupted as given in [CS ADR-DSN.L.560](#).

(c) Characteristics:

- (1) A runway centre line marking should consist of a line of uniformly spaced stripes and gaps. The length of a stripe plus a gap should be not less than 50 m or more than 75 m. The length of each stripe should be at least equal to the length of the gap or 30 m, whichever is greater.
- (2) The width of the stripes should be not less than:
  - (i) 0.90 m on precision approach Category II and III runways;
  - (ii) 0.45 m on non-precision approach runways where the code number is 3 or 4, and precision approach Category I runways; and
  - (iii) 0.30 m on non-precision approach runways where the code number is 1 or 2, and on non-instrument runways.

[Issue: ADR-DSN/3]

## GM1 ADR-DSN.L.530 Runway centre line marking

*ED Decision 2014/013/R*

For the centre line marking the 30 m length of and gap between stripes may be adjusted to take into consideration the runway thresholds locations.

## CS ADR-DSN.L.535 Threshold marking

*ED Decision 2016/027/R*

- (a) Applicability: A threshold marking should be provided at the threshold of a runway.
- (b) Characteristics:
  - (1) The stripes of the threshold marking should commence 6 m from the threshold.
  - (2) A runway threshold marking should consist of a pattern of longitudinal stripes of uniform dimensions disposed symmetrically about the centre line of a runway as shown in Figure L-1(A) and L-1(B) for a runway width of 45 m. The number of stripes should be in accordance with the runway width as follows:

Runway width	Number of stripes
18 m	4
23 m	6
30 m	8
45 m	12
60 m	16

except that on non-precision approach and non-instrument runways 45 m or greater in width, they may be as shown in Figure L-1(C).

- (3) The stripes should extend laterally to within 3 m of the edge of a runway or to a distance of 27 m on either side of a runway centre line, whichever results in the smaller lateral distance.
- (4) Where a runway designation marking is placed within a threshold marking, there should be a minimum of three stripes on each side of the centre line of the runway.



- (5) Where a runway designation marking is placed above a threshold marking, the stripes should be continued across the runway. The stripes should be at least 30 m long and approximately 1.80 m wide with spacings of approximately 1.80 m between them. Where the stripes are continued across a runway, a double spacing should be used to separate the two stripes nearest the centre line of the runway, and in the case where the designation marking is included within the threshold marking, this spacing should be 22.5 m.
- (c) Displaced threshold:
- (1) Where a threshold is displaced from the extremity of a runway or where the extremity of a runway is not square with the runway centre line, a transverse stripe as shown in Figure L-3(B) should be added to the threshold marking.
  - (2) A transverse stripe should be not less than 1.80 m wide.
  - (3) Where a runway threshold is permanently displaced, arrows conforming to Figure L-3(B) should be provided on the portion of the runway before the displaced threshold.
  - (4) When a runway threshold is temporarily displaced from the normal position, it should be marked as shown in Figure L-3(A) or L-3(B), and all markings prior to the displaced threshold should be obscured except the runway centre line marking which should be converted to arrows.

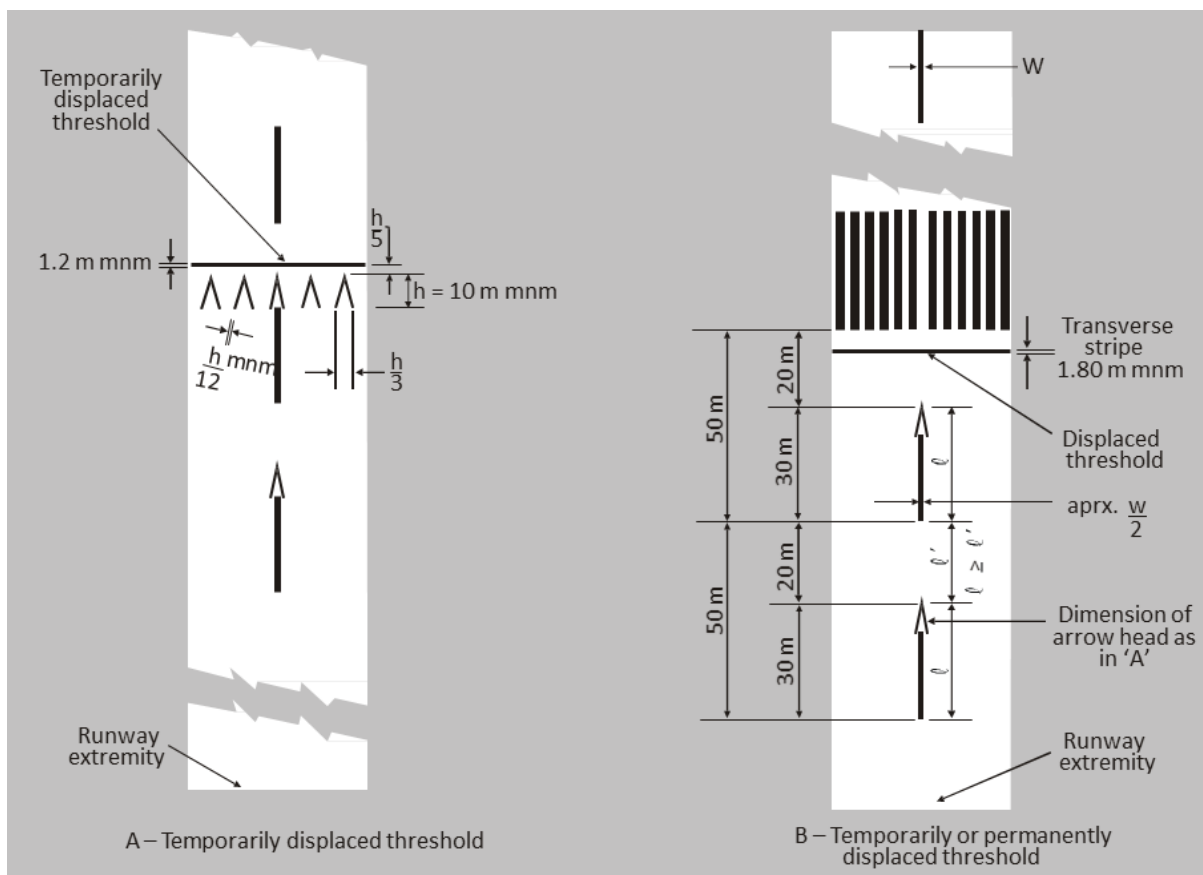


Figure L-3. Displaced threshold markings

[Issue: ADR-DSN/3]

## GM1 ADR-DSN.L.535 Threshold marking

ED Decision 2014/013/R

intentionally left blank

## CS ADR-DSN.L.540 Aiming point marking

ED Decision 2014/013/R

- (a) Applicability:
- (1) An aiming point marking should be provided at each approach end of an instrument runway where the code number is 2, 3, or 4.
  - (2) An aiming point marking should be provided when additional conspicuity of the aiming point is required at each approach end of:
    - (i) a non-instrument runway where the code number is 3 or 4,
    - (ii) an instrument runway where the code number is 1.
- (b) Characteristics. The aiming point marking should commence no closer to the threshold than the distance indicated in the appropriate column of Table L-1, except that, on a runway equipped with a PAPI system, the beginning of the marking should be coincident with the visual approach slope origin.

Location and dimensions	Landing distance available			
	Less than 800 m	800 m up to but not including 1 200 m	1 200 m up to but not including 2 400 m	2 400 m and above
(1)	(2)	(3)	(4)	(5)
Distance from threshold to beginning of marking <sup>a</sup>	150 m	250 m	300 m	400 m
Length of stripe <sup>b</sup>	30-45 m	30-45 m	45-60 m	45-60 m
Width of stripe	4 m	6 m	6-10 m <sup>c</sup>	6-10 m <sup>c</sup>
Lateral spacing between inner sides of stripes	6 m <sup>d</sup>	9 m <sup>d</sup>	18-22.5 m	18-22.5 m
a	Where a PAPI system is provided for the runway, the beginning of the marking should be coincident with the visual approach slope origin.			
b	Where greater dimensions of the specified ranges are intended to be used where increased conspicuity is required.			
c	Where lateral spacing may be varied within these limits to minimise the contamination of the marking by rubber deposits.			
d	These figures were deduced by reference to the outer main gear wheel span which is element 2 of the aerodrome reference code			

**Table L-1. Location and dimensions of aiming point marking**

- (c) An aiming point marking should consist of two conspicuous stripes. The dimensions of the stripes and the lateral spacing between their inner sides should be in accordance with the provisions of the appropriate column of Table L-1.

## GM1 ADR-DSN.L.540 Aiming point marking

*ED Decision 2017/021/R*

For runways with widths of 30 m, the width of the rectangular stripes of the aiming point marking and the lateral spacing between the inner sides of the stripes may be adjusted in proportion to the available runway width to avoid overlapping of the aiming point marking with the runway side stripe marking.

[Issue: ADR-DSN/4]

## CS ADR-DSN.L.545 Touchdown zone marking

*ED Decision 2016/027/R*

(a) Applicability:

- (1) A touchdown zone marking should be provided in the touchdown zone of a paved precision approach runway where the code number is 2, 3, or 4.
- (2) A touchdown zone marking should be provided in the touchdown zone of a paved non-precision approach or non-instrument runway where the code number is 3 or 4 and additional conspicuity of the touchdown zone is desirable.

(b) Location: A touchdown zone marking should consist of pairs of rectangular markings symmetrically disposed about the runway centre line with the number of such pairs related to the landing distance available and, where the marking is to be displayed at both the approach directions of a runway, the distance between the thresholds, as follows:

Landing distance available or the distance between thresholds	Pair(s) of markings
less than 900 m	1
900 m up to but not including 1 200 m	2
1 200 m up to but not including 1 500 m	3
1 500 m up to but not including 2 400 m	4
2 400 m or more	6

(c) Characteristics:

- (1) A touchdown zone marking should conform to the patterns shown in Figure L-4. For the pattern shown in Figure L-4(A), the markings should be not less than 22.5 m long and 3 m wide. For the pattern shown in Figure L-4(B), each stripe of each marking should be not less than 22.5 m long and 1.8 m wide with spacing of 1.5 m between adjacent stripes.
- (2) The lateral spacing between the inner sides of the rectangles should be equal to that of the aiming point marking where provided. Where an aiming point marking is not provided, the lateral spacing between the inner sides of the rectangles should correspond to the lateral spacing specified for the aiming point marking in Table L-1 (columns (2), (3), (4), or (5), as appropriate). The pairs of markings should be provided at longitudinal spacings of 150 m beginning from the threshold, except that pairs of touchdown zone markings coincident with or located within 50 m of an aiming point marking should be deleted from the pattern.
- (3) On a non-precision approach runway where the code number is 2, an additional pair of touchdown zone marking stripes should be provided 150 m beyond the beginning of the aiming point marking.

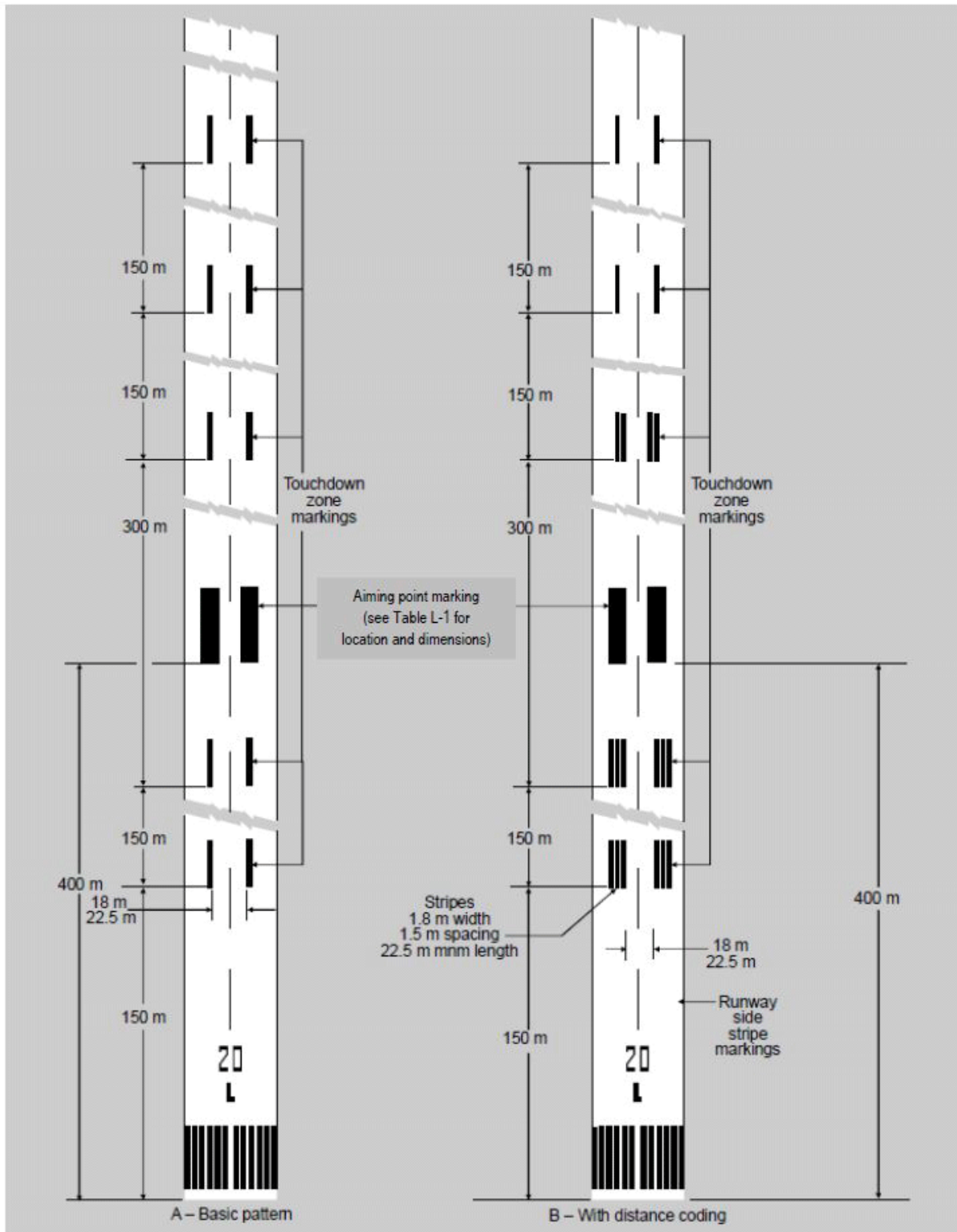


Figure L-4. Aiming point and touchdown zone markings (illustrated for a runway with a length of 2 400 m or more)

[Issue: ADR-DSN/3]

## GM1 ADR-DSN.L.545 Touchdown zone marking

ED Decision 2014/013/R

- (a) In order to give information regarding the overall extension of a distance coding touchdown marking, as specified in [CS ADR-DSN.L.545](#), the last pair of markings after the threshold should consist of two single stripes, and the other pairs should correspond to the patterns shown in Figure L-4.
- (b) Such sequential layout gives intuitive information about the extension of the touchdown zone and, as a consequence, of the LDA or of the distance between thresholds.

## CS ADR-DSN.L.550 Runway side stripe marking

ED Decision 2014/013/R

- (a) Applicability:
  - (1) A runway side stripe marking should be provided between the thresholds of a runway where there is a lack of contrast between the runway edges and the shoulders or the surrounding terrain.
  - (2) A runway side stripe marking should be provided on a precision approach runway irrespective of the contrast between the runway edges and the shoulders or the surrounding terrain.
- (b) Location and characteristics:
  - (1) A runway side stripe marking should consist of two stripes, one placed along each edge of the runway with the outer edge of each stripe approximately on the edge of the runway, except that, where the runway is greater than 60 m in width, the stripes should be located 30 m from the runway centre line.
  - (2) Where a runway turn pad is provided, the runway side stripe marking should be continued between the runway and the runway turn pad.
  - (3) A runway side stripe should have an overall width of at least 0.9 m on runways 30 m or more in width and at least 0.45 m on narrower runways.

## GM1 ADR-DSN.L.550 Runway side stripe marking

ED Decision 2014/013/R

When turn pads are not available at the end of a runway for back-track manoeuvres and threshold is displaced, in order to better identify full-strength bearing surface, it may be useful to display specific dashed markings as showed by Figure GM-L-1 and with dimensions described in Table GM-L-1.

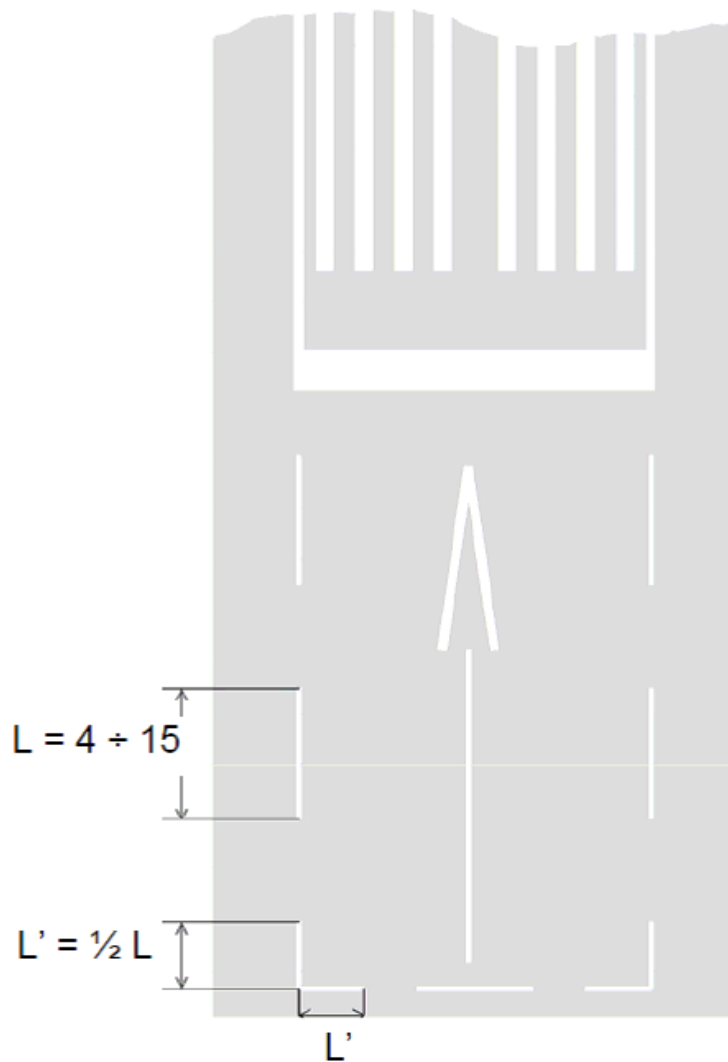


Figure GM-L-1. Dashed runway side stripe marking

Runway width (m)	Single dash dimensions	
	Length (minimum m)	Width (m)
60	15	0.45
45	15	0.45
30	10	0.45
23	6	0.25
18	4	0.25

Note: The length of the gap is as much as possible equal, but not longer, to the length of the corresponding marking

Table GM-L-1. Dashed runway side stripe markings

## CS ADR-DSN.L.555 Taxiway centre line marking

ED Decision 2016/027/R

(a) Applicability:

- (1) Taxiway centre line marking should be provided on a taxiway, de-icing/anti-icing facility and apron in such a way as to provide continuous guidance between the runway centre line and aircraft stands.
- (2) Taxiway centre line marking should be provided on a runway when the runway is part of a standard taxi-route and where the taxiway centre line is not coincident with the runway centre line.

(b) Characteristics:

- (1) On a straight section of a taxiway, the taxiway centre line marking should be located along the taxiway centre line.
- (2) On a taxiway curve, the marking should continue from the straight portion of the taxiway at a constant distance from the outside edge of the curve.
- (3) At an intersection of a taxiway with a runway, where the taxiway serves as an exit from the runway, the taxiway centre line marking should be curved into the runway centre line marking as shown in Figure L-5. The taxiway centre line marking should be extended parallel to the runway centre line marking for a distance of at least 60 m beyond the point of tangency where the code number is 3 or 4, and for a distance of at least 30 m where the code number is 1 or 2.
- (4) Where taxiway centre line marking is provided in accordance with (a) 2 above, the marking should be located on the centre line of the designated taxiway.
- (5) A taxiway centre line marking should be at least 15 cm in width and continuous in length except where it intersects with a runway-holding position marking or an intermediate holding position marking as shown in Figure L-5. Taxiway markings (shown with basic runway markings).

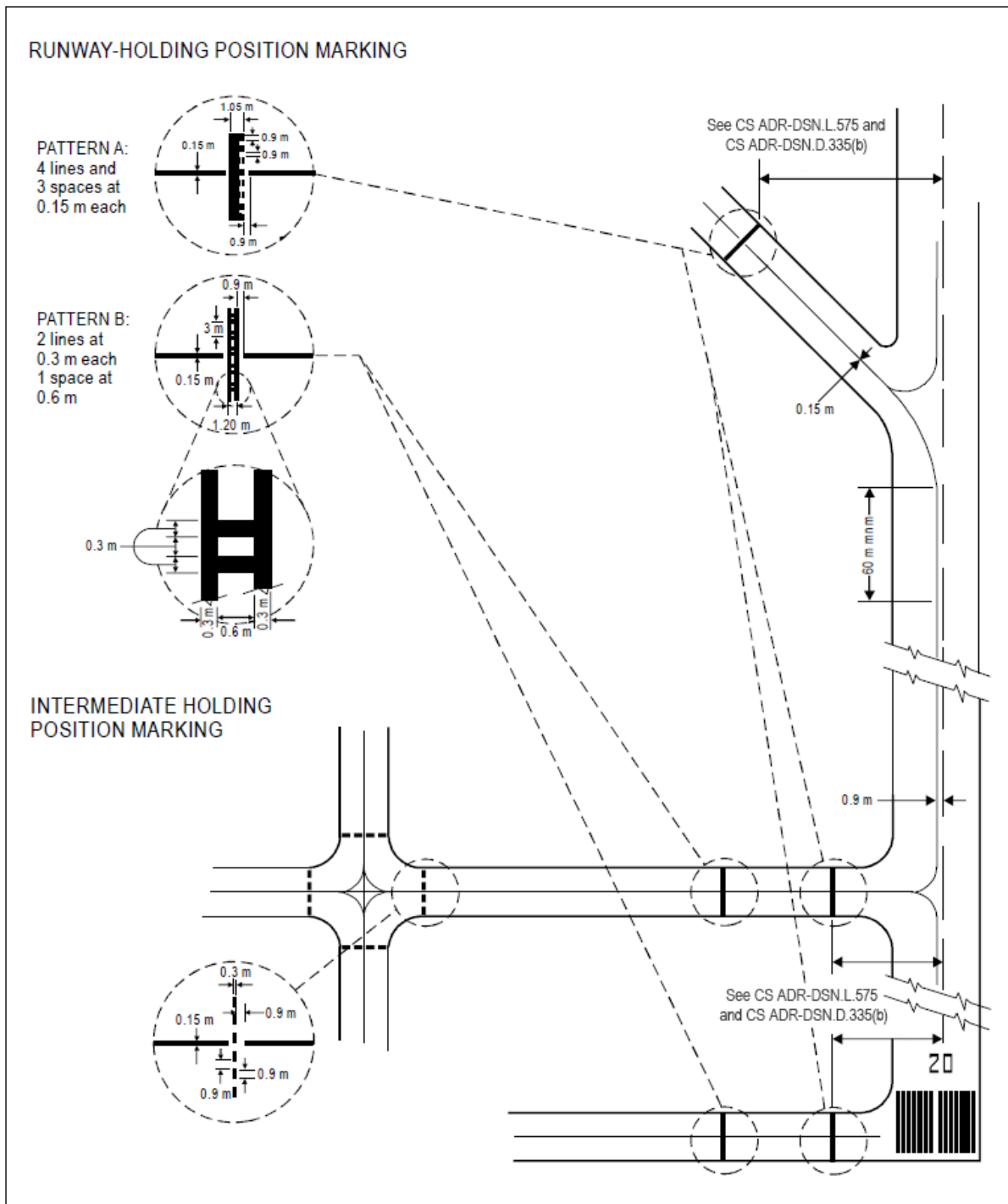


Figure L-5. Taxiway markings (shown with basic runway markings)

[Issue: ADR-DSN/3]

## GM1 ADR-DSN.L.555 Taxiway centre line marking

ED Decision 2016/027/R

The term ‘continuous guidance’ is not intended to require that taxiway centre line markings are provided onto aircraft stands. Instead, it is intended that the centre line marking be provided on taxiways leading to aircraft stands or other apron areas from which visual cues or other means exist,



such as lead-in arrows and stand number indicators, to enable aircrew to manoeuvre the aircraft onto a stand or other parking area.

[Issue: ADR-DSN/3]

## **CS ADR-DSN.L.560 Interruption of runway markings**

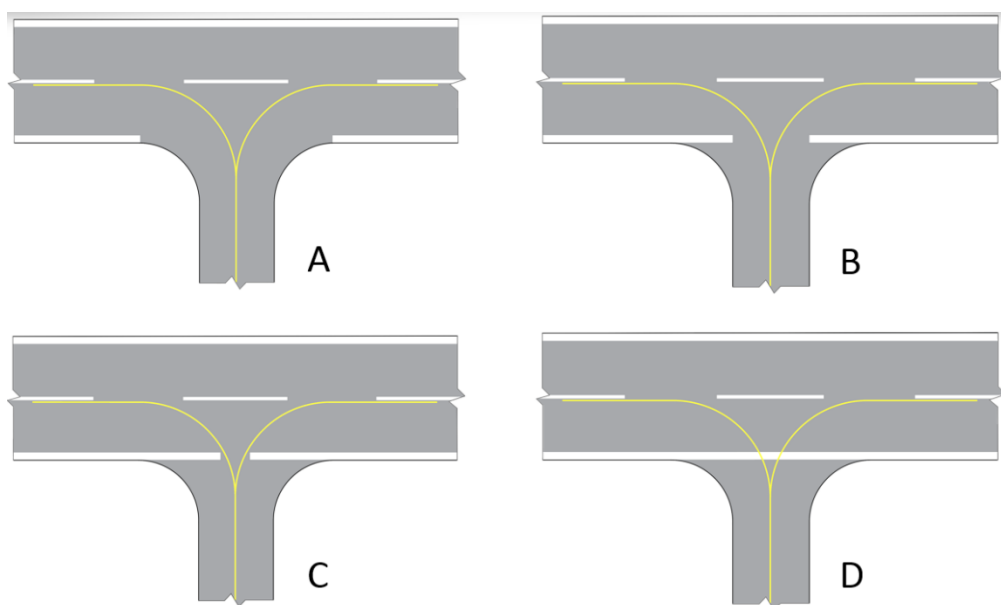
*ED Decision 2014/013/R*

- (a) At an intersection of two (or more) runways, the markings of the more important runway, except for the runway side stripe marking, should be displayed and the markings of the other runway(s) should be interrupted. The runway side stripe marking of the more important runway should be either continued across the intersection or interrupted.
- (b) The order of importance of runways for the display of runway markings should be as follows:
  - (1) precision approach runway;
  - (2) non-precision approach runway; and
  - (3) non-instrument runway.
- (c) At an intersection of a runway and taxiway the markings of the runway should be displayed and the markings of the taxiway interrupted, except that runway side stripe markings should be either continued across the intersection or interrupted.

## **GM1 ADR-DSN.L.560 Interruption of runway markings**

*ED Decision 2017/021/R*

- (a) At an intersection of a runway and taxiway, the runway side stripe marking should be either continued across the intersection or interrupted. The interruption means one of the following:
  - (1) the runway side stripe marking stops at the point where the taxiway fillet starts at either side of the taxiway (see Figure GM-L-2(A)); or
  - (2) the runway side stripe marking stops at the point where the extended line of the taxiway edge crosses the runway (see Figure GM-L-2(B)); or
  - (3) the runway side stripe marking stops at a short distance on either side of the taxiway centre line marking in order to allow visible and continuous taxiway centre line marking guidance (see Figure GM-L-2(C)); or
  - (4) the taxiway centre line marking overlays and therefore interrupts a continuous runway side stripe marking (see Figure GM-L-2(D)).



**Figure GM-L-2. Illustration of runway side stripe marking interruption**

- (b) The overall perception of the runway side stripe marking depends on conspicuity needs and local conditions, such as the number, location and disposition of runway/taxiway intersections, nature of the surrounding terrain, operational needs at aerodrome, weather, etc.

[Issue: ADR-DSN/4]

## CS ADR-DSN.L.565 Runway turn pad marking

ED Decision 2017/021/R

- (a) Applicability: Where a runway turn pad is provided, a runway turn pad marking should be provided for continuous guidance to enable an aeroplane to complete a 180-degree turn and align with the runway centre line.
- (b) Characteristics:
- (1) The runway turn pad marking should be curved from the runway centre line into the turn pad. The radius of the curve should be compatible with the manoeuvring capability and normal taxiing speeds of the aeroplanes for which the runway turn pad is intended.
  - (2) The intersection angle of the runway turn pad marking with the runway centre line should not be greater than 30 degrees.
  - (3) The runway turn pad marking should be extended parallel to the runway centre line marking for a distance of at least 60 m beyond the point of tangency where the code number is 3 or 4, and for a distance of at least 30 m where the code number is 1 or 2.
  - (4) A runway turn pad marking should guide the aeroplane in such a way as to allow a straight portion of taxiing before the point where a 180-degree turn is to be made. The straight portion of the runway turn pad marking should be parallel to the outer edge of the runway turn pad.
  - (5) The design of the curve allowing the aeroplane to negotiate a 180-degree turn should be based on a nose wheel steering angle not exceeding 45 degrees.
  - (6) The design of the turn pad marking should be such that when the cockpit of the aeroplane remains over the runway turn pad marking, the clearance distance between any wheel

of the aeroplane landing gear and the edge of the runway turn pad should be not less than those specified in [CS ADR-DSN.B.095\(c\)](#).

- (7) A runway turn pad marking should be at least 15 cm in width and continuous in length.

[Issue: ADR-DSN/4]

## GM1 ADR-DSN.L.565 Runway turn pad marking

*ED Decision 2017/021/R*

Where a runway turn pad is not provided, a marking for continuous guidance to enable an aeroplane to complete a 180-degree turn and align with the runway centre line may be provided. Such marking should be yellow, at least 15 cm in width and continuous in length.

[Issue: ADR-DSN/4]

## CS ADR-DSN.L.570 Enhanced taxiway centre line marking

*ED Decision 2016/027/R*

- (a) Where provided, an enhanced taxiway centre line marking should be installed at each taxiway/runway intersection where it is necessary to denote the proximity of a runway-holding position.
- (b) Characteristics:
- (1) Enhanced taxiway centre line marking should be as shown in Figure L-6. An enhanced taxiway centre line marking should extend from the runway-holding position Pattern A (as defined in Figure L-5) to a distance of up to 47 m in the direction of travel away from the runway (see Figure L-6(a)).
  - (2) If the enhanced taxiway centre line marking intersects another runway-holding position marking, such as for a precision approach Category II or III runway, that is located within 47 m of the first runway-holding position marking, the enhanced taxiway centre line marking should be interrupted 0.9 m prior to and after the intersected runway-holding position marking. The enhanced taxiway centre line marking should continue beyond the intersected runway-holding position marking for at least three dashed line segments or 47 m from start to finish, whichever is greater (see Figure L-6(b)).
  - (3) If the enhanced taxiway centre line marking continues through a taxiway/taxiway intersection that is located within 47 m of the runway-holding position marking, the enhanced taxiway centre line marking should be interrupted 1.5 m prior to and after the point where the intersected taxiway centre line crosses the enhanced taxiway centre line. The enhanced taxiway centre line marking should continue beyond the taxiway/taxiway intersection for at least three dashed line segments or 47 m from start to finish, whichever is greater (see Figure L-6(c)).
  - (4) Where two taxiway centre lines converge at or before the runway-holding position marking, the inner dashed line should not be less than 3 m in length (see Figure L-6(d)).
  - (5) Where there are two opposing runway-holding position markings and the distance between the markings is less than 94 m, the enhanced taxiway centre line markings should extend over this entire distance. The enhanced taxiway centre line markings should not extend beyond either runway-holding position marking (see Figure L-6(e)).

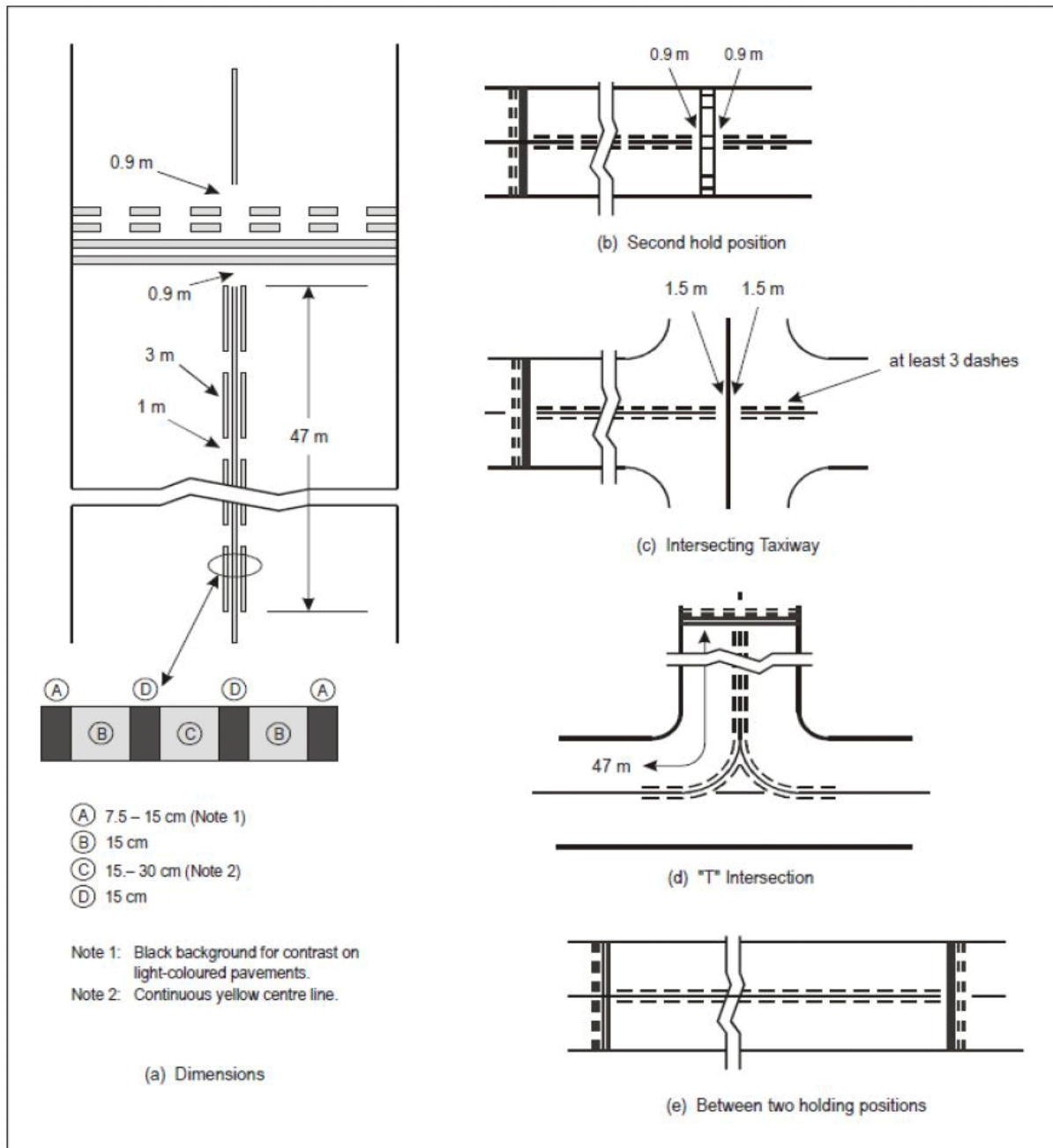


Figure L-6. Enhanced taxiway centre line marking

[Issue: ADR-DSN/3]

## GM1 ADR-DSN.L.570 Enhanced taxiway centre line marking

ED Decision 2016/027/R

The provision of enhanced taxiway centre line marking may form part of runway incursion prevention measures.

[Issue: ADR-DSN/3]

## CS ADR-DSN.L.575 Runway-holding position marking

ED Decision 2016/027/R

A runway-holding position marking should be displayed along a runway-holding position.

(a) Characteristics:

- (1) At an intersection of a taxiway and a non-instrument, non-precision approach or take-off runway, the runway-holding position marking should be as shown in Figure L-5, pattern A.
- (2) Where a single runway-holding position is provided at an intersection of a taxiway and a precision approach Category I, II or III runway, the runway-holding position marking should be as shown in Figure L-5, pattern A.
- (3) Where two or three runway-holding positions are provided at such an intersection, the runway-holding position marking closer (closest) to the runway should be as shown in Figure L-5, pattern A, and the markings farther from the runway should be as shown in Figure L-5, pattern B.
- (4) The runway-holding position marking displayed at a runway-holding position established in accordance with [CS ADR-DSN.D.335\(b\)\(1\)](#) should be as shown in Figure L-5, pattern A.
- (5) Where increased conspicuity of the runway-holding position is required, the runway-holding position marking should be as shown in Figure L-7, pattern A or pattern B, as appropriate.
- (6) Where a pattern B runway-holding position marking is located on an area where it would exceed 60 m in length, a mandatory instruction marking containing the term 'CAT II' or 'CAT III' as appropriate should be marked on the surface at the ends of the runway-holding position marking and at equal intervals of 45 m maximum between successive marks. The letters should be not less than 1.8 m high and should be placed not more than 0.9 m on the holding side of the runway holding position marking.
- (7) The runway-holding position marking displayed at a runway/runway intersection should be perpendicular to the centre line of the runway forming part of the standard taxi-route. The pattern of the marking should be as shown in Figure L-7, pattern A.

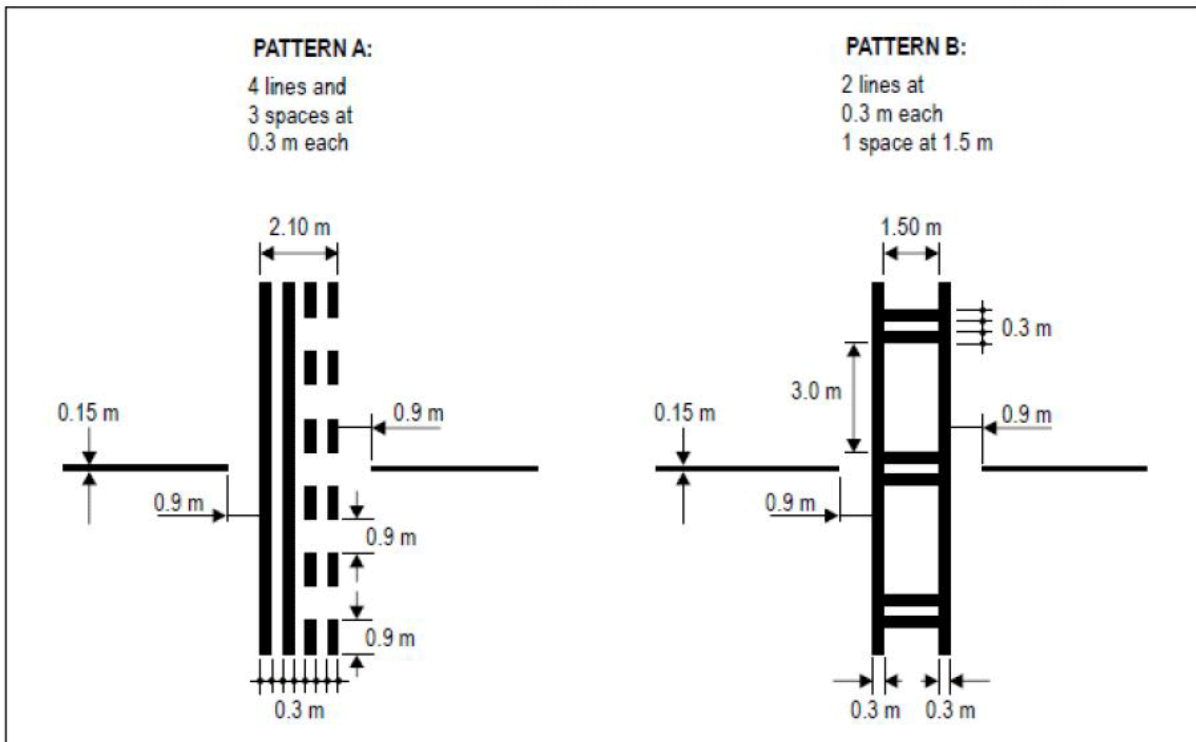


Figure L-7. Runway-holding position markings

[Issue: ADR-DSN/3]

## GM1 ADR-DSN.L.575 Runway-holding position marking

ED Decision 2014/013/R

When the Runway-holding position marking is supplemented with the term 'CAT II' or 'CAT III' on the areas or taxiways exceeding 60 m in accordance with [CS ADR-DSN.L.575\(a\)\(6\)](#) and should be placed along with the Mandatory instruction marking in accordance with [CS ADR-DSN.L.605](#) both markings should be equally and symmetrically placed one next to another.

## CS ADR-DSN.L.580 Intermediate holding position marking

ED Decision 2016/027/R

(a) Applicability:

- (1) An intermediate holding position marking should be displayed along an intermediate holding position.
- (2) An intermediate holding position marking should be displayed at the exit boundary of a remote de-icing/anti-icing facility adjoining a taxiway.

(b) Location:

- (1) Where an intermediate holding position marking is displayed at an intersection of two taxiways, it should be located across the taxiway at sufficient distance from the near edge of the intersecting taxiway to ensure safe clearance between taxiing aircraft. It should be coincident with a stop bar or intermediate holding position lights where provided.
- (2) The distance between an intermediate holding position marking at the exit boundary of a remote de-icing/anti-icing facility and the centre line of the adjoining taxiway should not be less than the dimension specified in the table below.

Code letter	Distance (metres)
A	15.5
B	20
C	26
D	37
E	43.5
F	51

- (c) Characteristics: An intermediate holding position marking should consist of a single broken line as shown in Figure L-5.

[Issue: ADR-DSN/3]

## GM1 ADR-DSN.L.580 Intermediate holding position marking

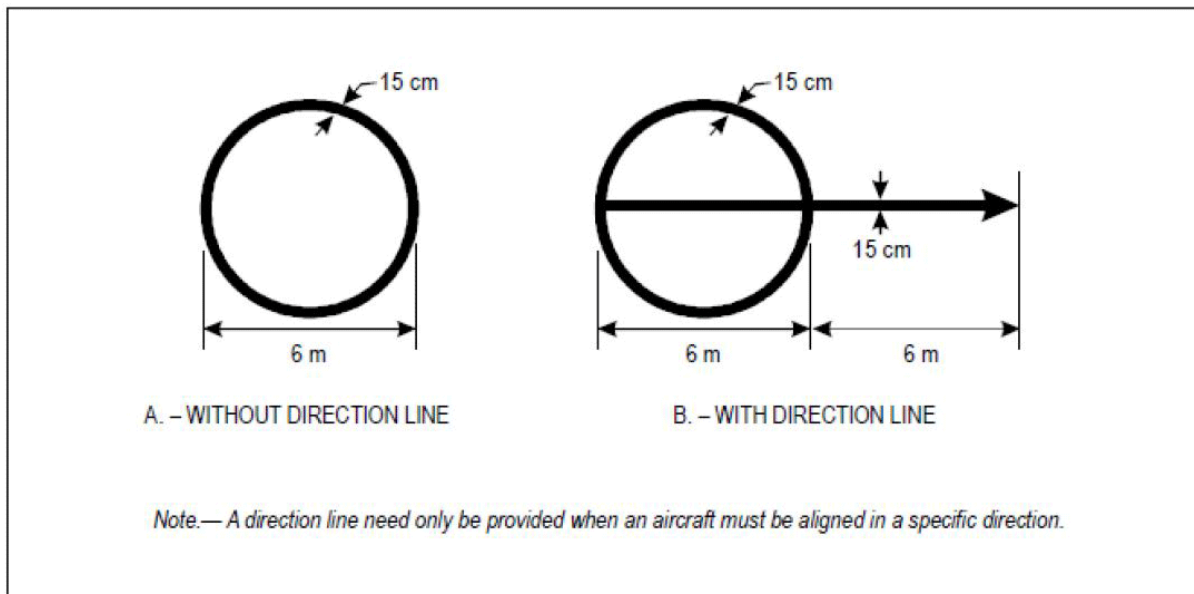
*ED Decision 2014/013/R*

intentionally left blank

## CS ADR-DSN.L.585 VOR aerodrome checkpoint marking

*ED Decision 2016/027/R*

- (a) Applicability: When a VOR aerodrome check-point is established, it should be indicated by a VOR aerodrome check-point marking and sign.
- (b) Location: A VOR aerodrome check-point marking should be centred on the spot at which an aircraft is to be parked to receive the correct VOR signal.
- (c) Characteristics:
- (1) A VOR aerodrome check-point marking should consist of a circle 6 m in diameter and have a line width of 15 cm (see Figure L-8(A)).
  - (2) When it is preferable for an aircraft to be aligned in a specific direction, a line should be provided that passes through the centre of the circle on the desired azimuth. The line should extend 6 m outside the circle in the desired direction of heading and terminate in an arrowhead. The width of the line should be 15 cm (see Figure L-8(B)).
  - (3) A VOR aerodrome check-point marking should differ from the colour used for the taxiway markings and when applicable from a contrasting viewpoint, be white in colour.



**Figure L-8. VOR check-point markings**

[Issue: ADR-DSN/3]

## GM1 ADR-DSN.L.585 VOR aerodrome checkpoint marking

ED Decision 2016/027/R

Further guidance on the selection of sites for VOR aerodrome checkpoints is given in ICAO Annex 10, Volume I, Attachment E.

[Issue: ADR-DSN/3]

## CS ADR-DSN.L.590 Aircraft stand marking

ED Decision 2014/013/R

- (a) Applicability: Aircraft stand markings should be provided for designated parking positions on an apron and on a de-icing/anti-icing facility.
- (b) General characteristics: Aircraft stand markings should include such elements as stand identification, lead-in line, turn bar, turning line, alignment bar, stop line and lead-out line as are required by the parking configuration and to complement other parking aids.
- (c) Aircraft stand identification:
  - (1) An aircraft stand identification (letter and/or number) should be included in the lead-in line a short distance after the beginning of the lead-in line. The height of the identification should be adequate to be readable from the cockpit of aircraft using the stand.
  - (2) Identification of the aircraft for which each set of markings is intended, should be added to the stand identification where two sets of aircraft stand markings are superimposed on each other in order to permit more flexible use of the apron and safety would be impaired if the wrong marking was followed.
- (d) Lead-in, turning, and lead-out lines:
  - (1) Lead-in, turning, and lead-out lines should, as far as practicable, be continuous in length and have a width of not less than 15 cm. Where one or more sets of stand markings are



- superimposed on a stand marking, the lines should be continuous for the most demanding aircraft and broken for other aircraft.
- (2) The curved portions of lead-in, turning, and lead-out lines should have radii appropriate to the most demanding aircraft type for which the markings are intended.
  - (3) Where it is intended that an aircraft proceeds in one direction only, arrows pointing in the direction to be followed should be added as part of the lead-in and lead-out lines.
- (e) **Alignment bar:** An alignment bar should be placed so as to be coincident with the extended centre line of the aircraft in the specified parking position and visible to the pilot during the final part of the parking manoeuvre. It should have a width of not less than 15 cm.
- (f) **Turn bar and stop line:**
- (1) A turn bar should be located at right angles to the lead-in line, abeam the left pilot position at the point of initiation of any intended turn. It should have a length and width of not less than 6 m and 15 cm respectively, and include an arrowhead to indicate the direction of turn.
  - (2) A stop line should be located at right angles to the alignment bar, abeam the left pilot position at the intended point of stop. It should have a length and width of not less than 6 m and 15 cm respectively.
  - (3) If more than one turn bar and/or stop line is required, they should be designated for the appropriate aircraft types.

## GM1 ADR-DSN.L.590 Aircraft stand marking

*ED Decision 2014/013/R*

- (a) The distances to be maintained between the stop line and the lead-in line may vary according to different aircraft types, taking into account the pilot's field of view.
- (b) Apron markings are installed to support the safe operation of aircraft on stands and apron areas. Where appropriate procedures are employed, markings may not be required, giving flexibility of operations. Examples would include situations where aircraft marshallers are used or where aircraft are required to self-park on an open apron where different combinations of aircraft preclude dedicated markings. Specific markings/stands are normally more applicable for larger aircraft.

## CS ADR-DSN.L.595 Apron safety lines

*ED Decision 2014/013/R*

- (a) **Applicability:** Apron safety lines should be provided on an apron as required by the parking configurations and ground facilities.
- (b) **Location:** Apron safety lines should be located so as to define the areas intended for use by ground vehicles and other aircraft servicing equipment to provide safe separation from aircraft.
- (c) **Characteristics:**
  - (1) Apron safety lines should include such elements as wing tip clearance lines and service road boundary lines as required by the parking configurations and ground facilities.
  - (2) Apron safety lines should be of a conspicuous colour which should contrast with that used for aircraft stand markings.

- (3) An apron safety line should be continuous in length and at least 10 cm in width.

## GM1 ADR-DSN.L.595 Apron safety lines

*ED Decision 2016/027/R*

- (a) Ground equipment and vehicles should be kept outside predetermined limits when aircraft are manoeuvring or when the equipment is left unattended.
- (b) Safety lines are required on an apron to mark the limits of parking areas for ground equipment, apron service roads and passengers' paths, etc. These lines are narrower and of a different colour to differentiate them from the guidelines used for aircraft.
- (1) Wing tip clearance lines. These lines should delineate the safety zone clear of the path of the critical aeroplane wing tip. The line should be drawn at appropriate distance outside the normal path of the wing tip of the critical aeroplane;
- (2) Equipment limit lines. These lines are used to indicate the limits of areas which are intended for parking vehicles and aircraft servicing equipment when they are not in use.
- (c) Several methods may be used to identify which side of a safety line is safe for storage of such vehicles and equipment:
- (1) Spurs or an additional line (a discontinuous line of the same colour or a continuous line of a different conspicuous colour) may be provided on one side of the safety line. The side on which such spurs or an additional line is located is considered safe for parking vehicles and equipment;
- (2) The words 'Equipment Limit' may be painted on the side used by ground equipment and readable from that side;
- (3) Passenger path lines. These lines are used to indicate to passengers and escorting personnel the route that needs to be followed, when walking on the apron, in order to be clear of hazards. A pair of lines with zebra hatching between them may be used.

[Issue: ADR-DSN/3]

## CS ADR-DSN.L.597 Apron service road marking

*ED Decision 2016/027/R*

- (a) Applicability: The limits of an apron service road, should be defined by apron service road markings.
- (b) Location: Apron service road markings should define the areas intended for use by ground vehicles and other aircraft servicing equipment to provide safe separation from aircraft.
- (c) Characteristics:
- (1) Apron service road markings should be white.
- (2) Apron service road markings should be continuous in length on the edges, continuous or broken in the middle, as appropriate, and at least 10 cm in width.
- (3) When an apron service road crosses a taxiway or aircraft stand taxilane, the apron service road edge marking should be laterally dashed along the crossing. The stripes should be 1.0 m in length, and their width should be equal to the width of the continuous part of the marking.

- (d) Apron service road markings should be discontinued when they intersect with other markings on an apron. The interrupted gap should be not more than 1 m on each side from the edge of the interested marking.

[Issue: ADR-DSN/3]

## GM1 ADR-DSN.L.597 Apron service road marking

ED Decision 2016/027/R

- (a) The term service road encompasses also other types of roads, such as the perimeter service roads, which are used to provide access to security or maintenance services etc. of the aerodrome. However, such types of service roads do not fall under the term ‘apron service road’.
- (b) When an apron service road crosses a taxiway, a separate road-holding position sign, in accordance with [CS ADR-DSN.N.800](#), or road-holding position marking, in accordance with [CS ADR-DSN.L.600](#), should indicate that vehicles are required to stop.
- (c) Markings located on an apron are prescribed in [CS ADR-DSN.L.555](#), [CS ADR-DSN.L.590](#) and [CS ADR-DSN.L.595](#).

[Issue: ADR-DSN/3]

## CS ADR-DSN.L.600 Road-holding position marking

ED Decision 2016/027/R

- (a) Applicability: A road-holding position marking should be provided at all road entrances or intersections to a runway or a taxiway.
- (b) Location:
- (1) The road-holding position marking should be located across the road at the holding position.
  - (2) Where a road intersects a taxiway, a road-holding position marking should be located across the road at the appropriate distance to ensure vehicles remain clear of the taxiway strip.
- (c) Characteristics:
- (1) The road-holding position marking should be in accordance with the local road traffic regulations.
  - (2) The road-holding position marking at the intersection of a road with a taxiway should be in accordance with the local traffic regulations for a yield right-of-way or mandatory stop.

[Issue: ADR-DSN/3]

## GM1 ADR-DSN.L.600 Road-holding position marking

ED Decision 2016/027/R

- (a) Where a road that accesses a runway or a taxiway is unpaved, it may not be possible to install markings. In such cases, a road-holding position signs and/or lights should be installed, combined with appropriate instructions on how the driver of a vehicle should proceed.
- (b) Where it is possible to install markings, they should conform to national regulations for traffic signs and markings.

[Issue: ADR-DSN/3]

## CS ADR-DSN.L.605 Mandatory instruction marking

ED Decision 2017/021/R

- (a) Applicability:
- (1) Where a mandatory instruction sign in accordance with [CS ADR-DSN.N.780](#) is not installed, a mandatory instruction marking should be provided on the surface of the pavement.
  - (2) On taxiways exceeding 60 m in width, or to assist in the prevention of a runway incursion, a mandatory instruction sign should be supplemented by a mandatory instruction marking.
- (b) Location:
- (1) The mandatory instruction marking on taxiways, where the code letter is A, B, C, or D, should be located across the taxiway equally placed about the taxiway centre line and on the holding side of the runway-holding position marking as shown in Figure L-9(A). The distance between the nearest edge of the marking and the runway-holding position marking or the taxiway centre line marking should be not less than 1 m.
  - (2) The mandatory instruction marking on taxiways where the code letter is E or F, should be located on the both sides of the taxiway centre line marking and on the holding side of the runway-holding position marking as shown in Figure L-9(B). The distance between the nearest edge of the marking and the runway-holding position marking, or the taxiway centre line marking should be not less than 1 m.
- (c) Characteristics:
- (1) A mandatory instruction marking should consist of an inscription in white on a red background. Except for a NO ENTRY marking, the inscription should provide information identical to that of the associated mandatory instruction sign.
  - (2) A NO ENTRY marking should consist of an inscription in white reading NO ENTRY on a red background.
  - (3) Where there is insufficient contrast between the marking and the pavement surface, the mandatory instruction marking should include an appropriate border, preferably white or black.
  - (4) The character height should be 4 m for inscriptions where the code letter is C, D, E, or F, and at least 2 m where the code letter is A or B. The inscription should be in the form and proportions shown in Figures L-10A to L-10D.
  - (5) The background should be rectangular and extend a minimum of 0.5 m laterally and vertically beyond the extremities of the inscription.
  - (6) The spacing of characters for mandatory instruction marking should be obtained by first determining the equivalent elevated sign character height and then proportioning from the spacing values given in Table N-3.

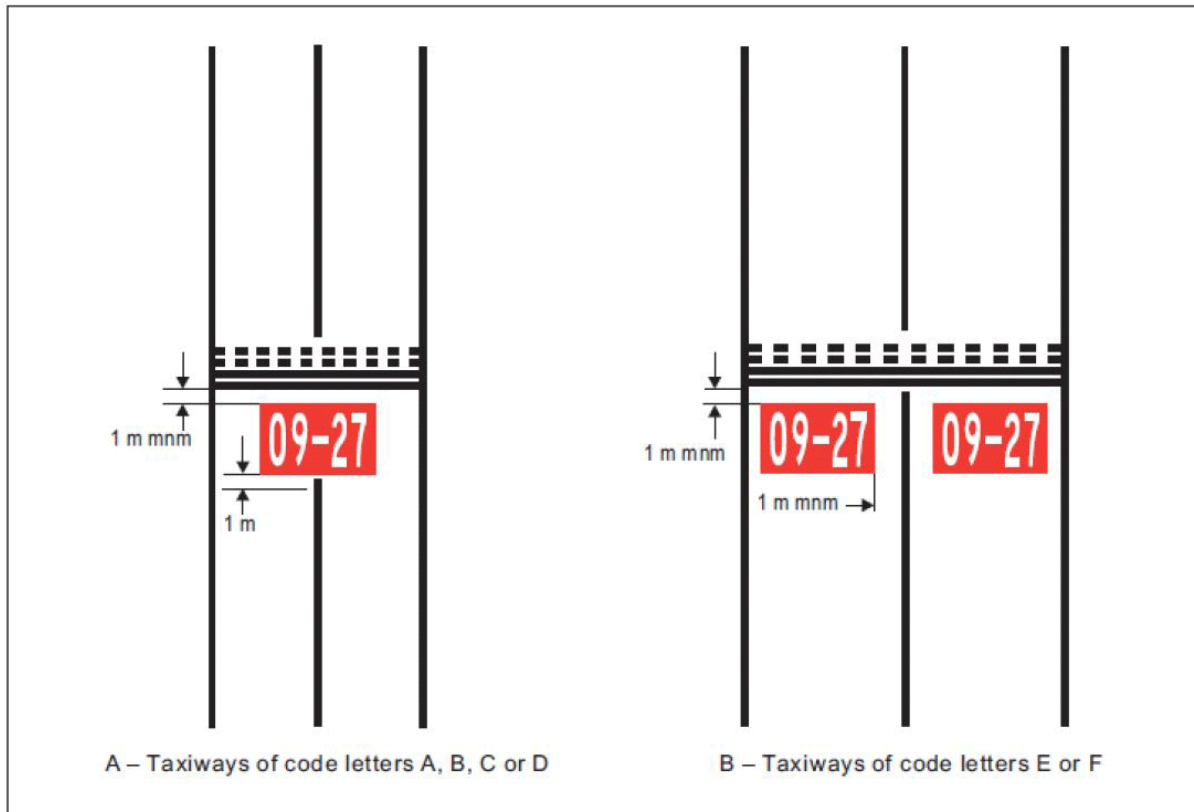


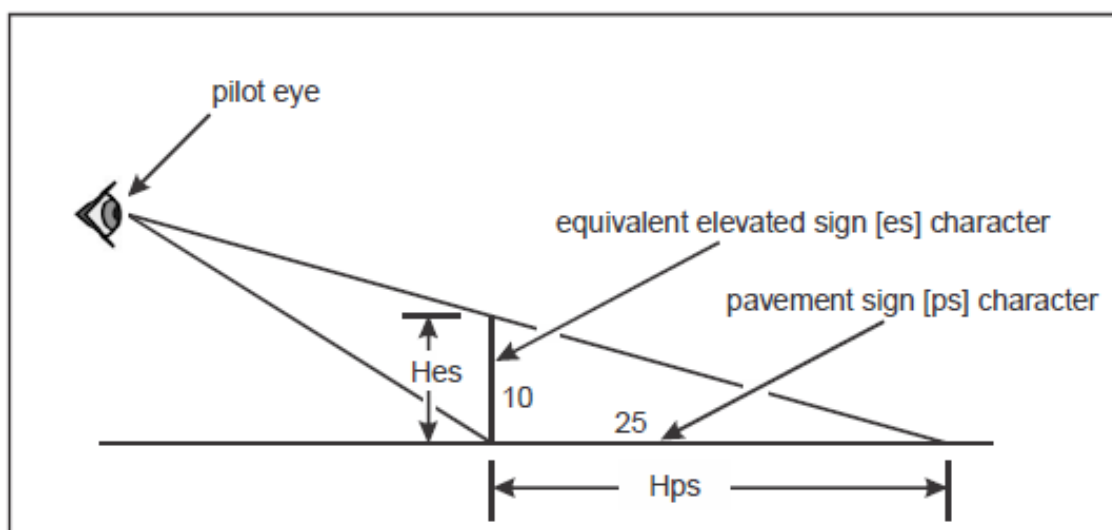
Figure L-9. Mandatory instruction marking

[Issue: ADR-DSN/3]  
[Issue: ADR-DSN/4]

## GM1 ADR-DSN.L.605 Mandatory instruction marking

ED Decision 2017/021/R

- (a) Except where operationally required, a mandatory instruction marking should not be located on a runway.
- (b) The mandatory instruction markings and information markings on pavements are formed as if shadowed (i.e. stretched) from the characters of an equivalent elevated sign by a factor of 2.5, as illustrated in Figure GM-L-3. The shadowing only affects the vertical dimension.



**Figure GM-L-3. Illustration of pavement marking spacing calculation**

- (c) The following example illustrates how the pavement marking spacing is to be calculated:
- (1) in the case of runway designator '10', which is to have a height of 4 000 mm (Hps), the equivalent elevated sign character height is  $4\,000/2.5 = 1\,600$  mm (Hes);
  - (2) Table N-3(b) indicates numeral to numeral code 1 and from Table N-3(c) this code has a dimension of 96 mm, for a character height of 400 mm;
  - (3) the pavement marking spacing for '10' is then  $(1\,600/400) \times 96 = 384$  mm.

[Issue: ADR-DSN/4]

## CS ADR-DSN.L.610 Information marking

ED Decision 2017/021/R

- (a) Applicability: Where an information sign in accordance with [CS ADR-DSN.N.785](#) is not installed, an information marking should be displayed on the surface of the pavement.
- (b) Characteristics:
  - (1) An information marking should consist of:
    - (i) an inscription in yellow upon a black background when it replaces or supplements a location sign; and
    - (ii) an inscription in black upon a yellow background when it replaces or supplements a direction or destination sign.
  - (2) Where there is insufficient contrast between the marking background and the pavement surface, the marking should include:
    - (i) a black border where the inscriptions are in black; and
    - (ii) a yellow border where the inscriptions are in yellow.
  - (3) The character height should be as for mandatory instruction markings.
  - (4) The spacing of characters for information marking should be as specified in Table N-3(c).

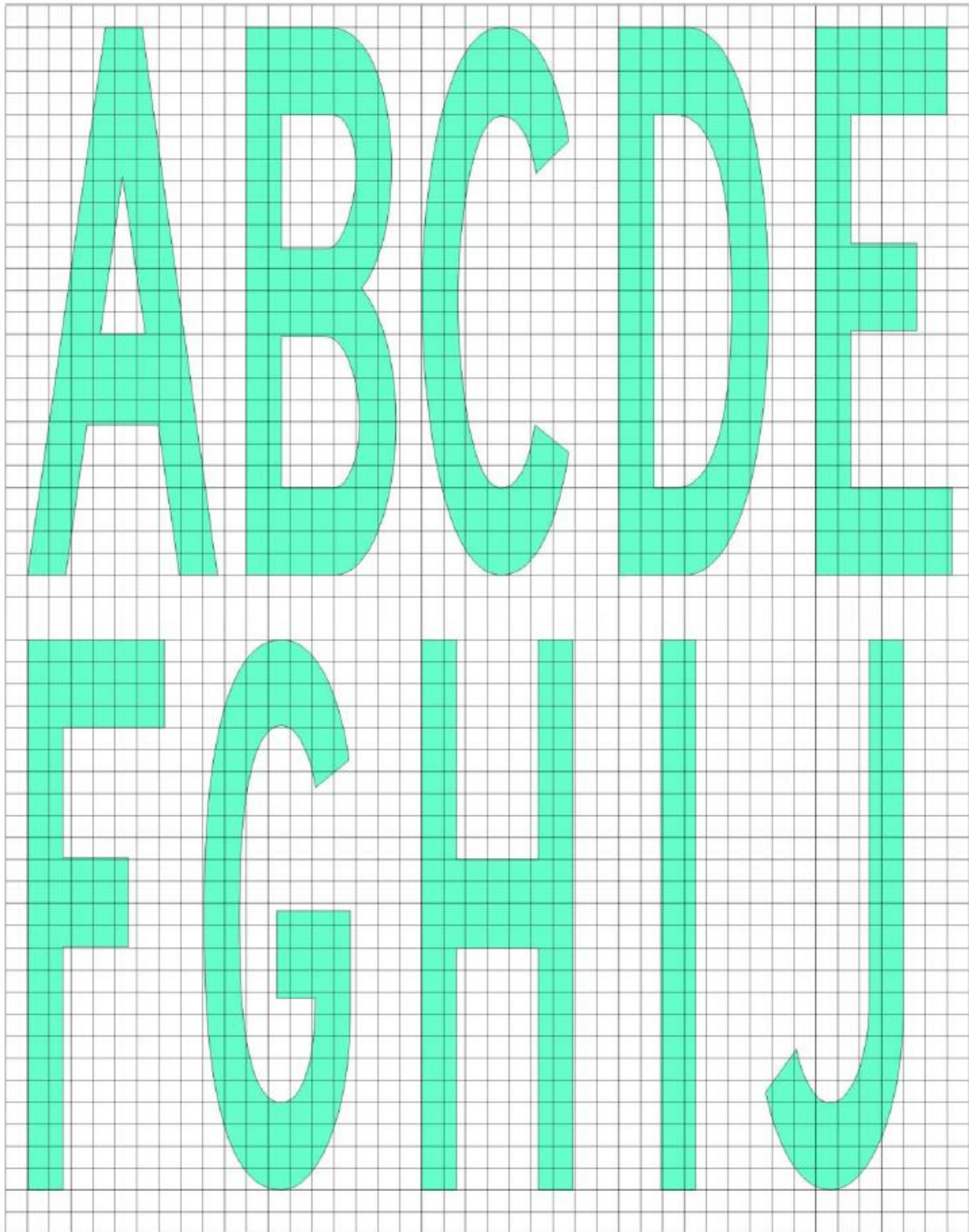


Figure L-10A. Mandatory instruction marking inscription form and proportions



**Figure L-10B. Mandatory instruction marking inscription form and proportions**



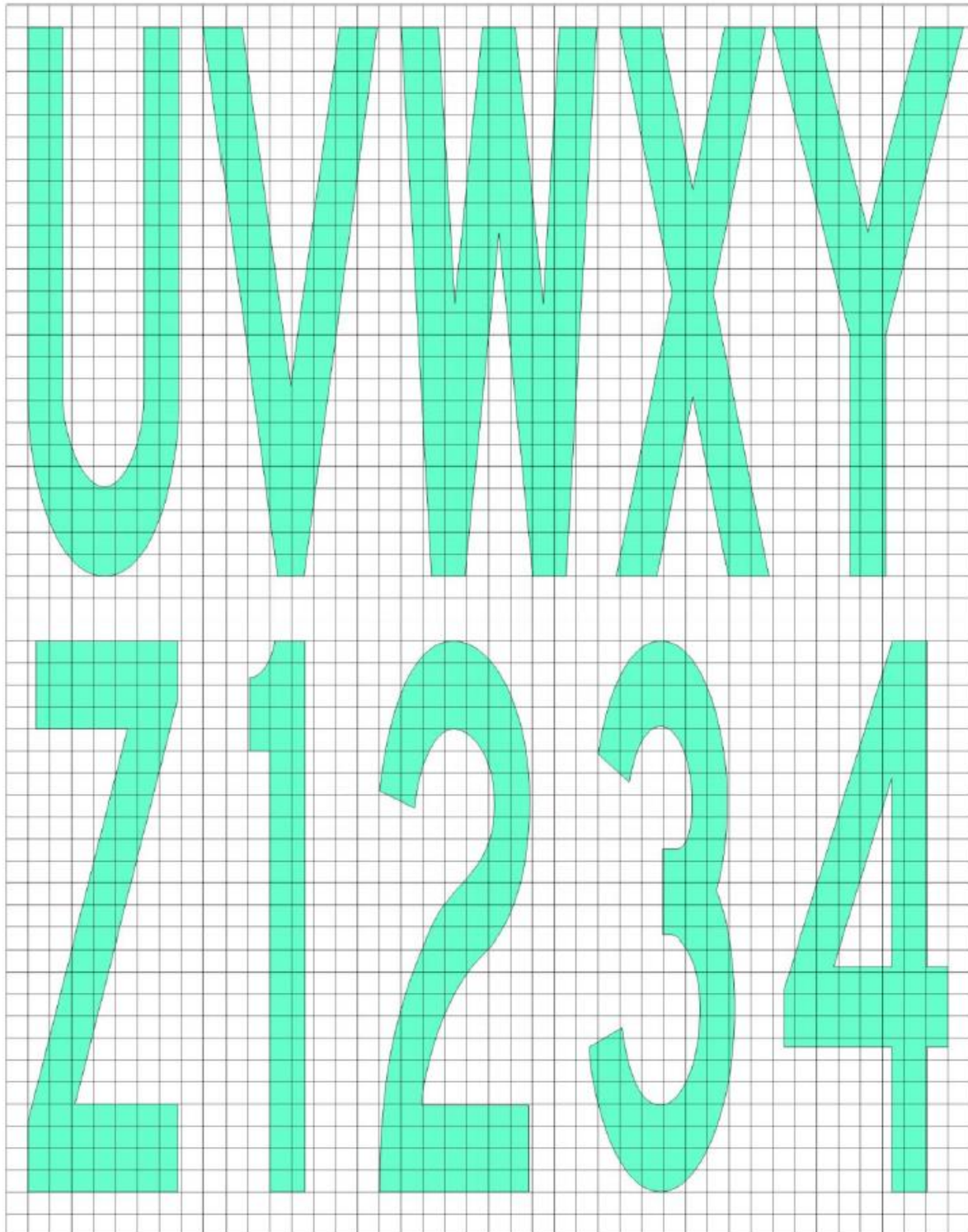
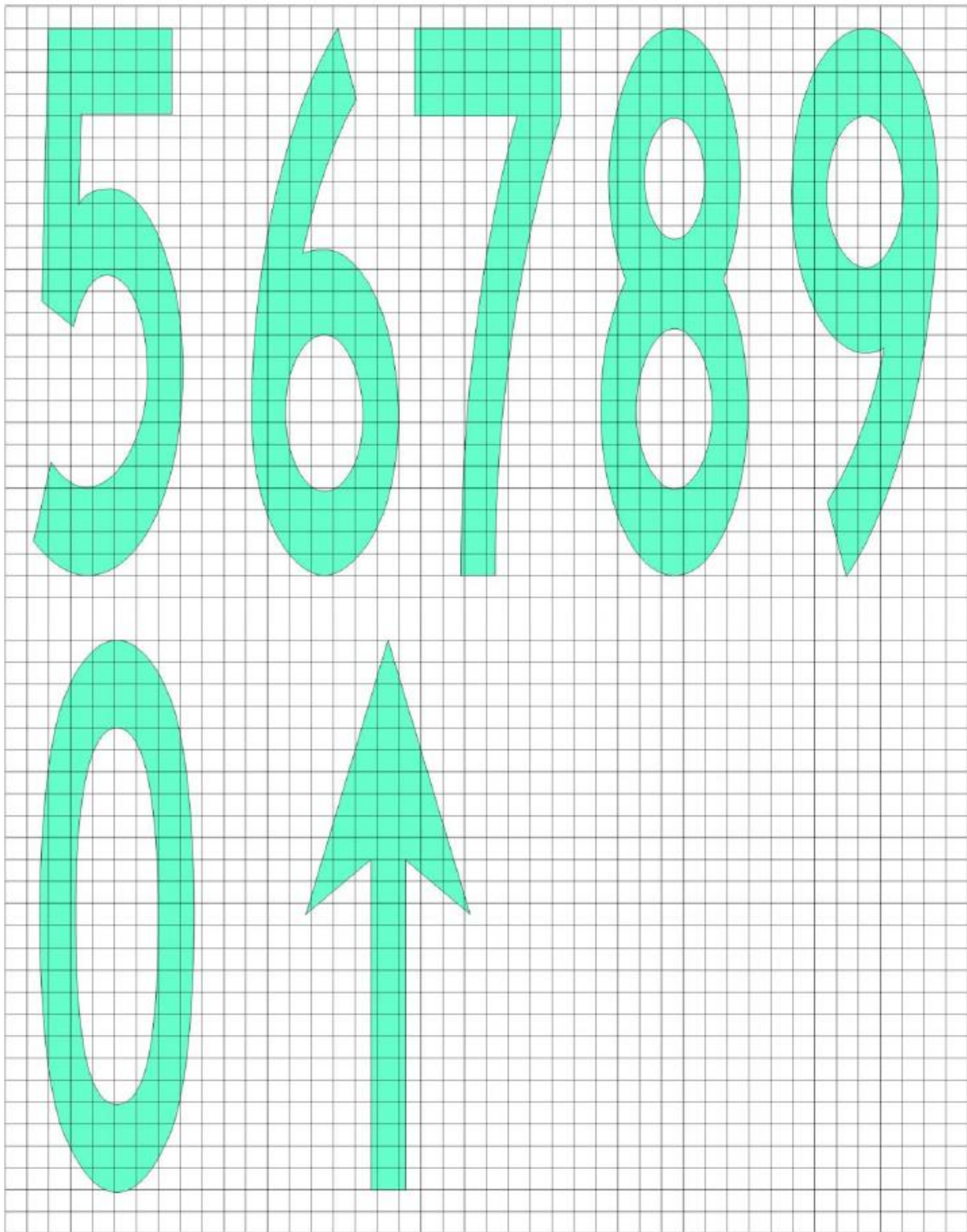


Figure L-10C. Mandatory instruction marking inscription form and proportions



**Figure L-10D. Mandatory instruction marking inscription form and proportions**

[Issue: ADR-DSN/3]

[Issue: ADR-DSN/4]

## GM1 ADR-DSN.L.610 Information marking

*ED Decision 2014/013/R*

- (a) Applicability: Where operationally required information sign should be supplemented by a marking on the pavement surface.
- (b) Location:
  - (1) An information (location/direction) marking should be displayed prior to and following complex taxiway intersections, and where operational experience has indicated the addition of a taxiway location marking could assist flight crew ground navigation, and on the pavement surface at regular intervals along taxiways of great length.
  - (2) The information marking should be displayed across the surface of the taxiway or apron where necessary, and positioned so as to be legible from the cockpit of an approaching aircraft.

## CHAPTER M — VISUAL AIDS FOR NAVIGATION (LIGHTS)

### CS ADR-DSN.M.615 General

ED Decision 2014/013/R

- (a) Elevated approach lights:
- (1) Elevated approach lights and their supporting structures should be frangible except that, in that portion of the approach lighting system beyond 300 m from the threshold:
    - (i) where the height of a supporting structure exceeds 12 m, the frangibility requirement should apply to the top 12 m only; and
    - (ii) where a supporting structure is surrounded by non-frangible objects, only that part of the structure that extends above the surrounding objects should be frangible.
  - (2) When an approach light fixture or supporting structure is not in itself sufficiently conspicuous, it should be suitably marked.
- (b) Elevated lights:
- Elevated runway, stopway, and taxiway lights should be frangible. Their height should be sufficiently low to preserve clearance for propellers and for the engine pods of jet aircraft.
- (c) Surface lights:
- (1) Light fixtures inset in the surface of runways, stopways, taxiways, and aprons should be so designed and fitted as to withstand being run over by the wheels of an aircraft without damage either to the aircraft or to the lights themselves.
  - (2) The temperature produced by conduction or radiation at the interface between an installed inset light and an aircraft tire should not exceed 160°C during a 10-minute period of exposure.
- (d) Light intensity and control:
- (1) The intensity of runway lighting should be adequate for the minimum conditions of visibility and ambient light in which use of the runway is intended, and compatible with that of the nearest section of the approach lighting system when provided.
  - (2) Where a high-intensity lighting system is provided, a suitable intensity control should be incorporated to allow for adjustment of the light intensity to meet the prevailing conditions. Separate intensity controls or other suitable methods should be provided to ensure that the following systems when installed, can be operated at compatible intensities:
    - (i) approach lighting system;
    - (ii) runway edge lights;
    - (iii) runway threshold lights;
    - (iv) runway end lights;
    - (v) runway centre line lights;
    - (vi) runway touchdown zone lights; and
    - (vii) taxiway centre line lights.

- (3) On the perimeter of and within the ellipse defining the main beam in [CS ADR-DSN.U.940](#), the maximum light intensity value should not be greater than three times the minimum light intensity value measured in accordance with [CS ADR-DSN.U.940](#).

On the perimeter of and within the rectangle defining the main beam in [CS ADR-DSN.U.940](#), the maximum light intensity value should not be greater than three times the minimum light intensity value measured in accordance with [CS ADR-DSN.U.940](#).

## GM1 ADR-DSN.M.615 General

ED Decision 2014/013/R

- (a) Aeronautical ground lights near navigable waters should be taken into consideration to ensure that the lights do not cause confusion to mariners.
- (b) In dusk or poor visibility conditions by day, lighting can be more effective than marking. For lights to be effective in such conditions or in poor visibility by night, they should be of adequate intensity. To obtain the required intensity, it should usually be necessary to make the light directional, in which case the arcs over which the light shows should be adequate and so orientated as to meet the operational requirements. The runway lighting system should be considered as a whole, to ensure that the relative light intensities are suitably matched to the same end.
- (c) While the lights of an approach lighting system may be of higher intensity than the runway lighting, it is good practice to avoid abrupt changes in intensity as these could give a pilot a false impression that the visibility is changing during approach.
- (d) The conspicuity of a light depends on the impression received of contrast between the light and its background. If a light is to be useful to a pilot by day when on approach, it should have an intensity of at least 2 000 or 3 000 cd, and in the case of approach lights an intensity of the order of 20 000 cd is desirable. In conditions of very bright daylight fog it may not be possible to provide lights of sufficient intensity to be effective.
- (e) On the other hand, in clear weather on a dark night, an intensity of the order of 100 cd for approach lights and 50 cd for the runway edge lights may be found suitable. Even then, owing to the closer range at which they are viewed, pilots have sometimes complained that the runway edge lights seemed unduly bright.
- (f) In fog the amount of light scattered is high. At night this scattered light increases the brightness of the fog over the approach area and runway to the extent that little increase in the visual range of the lights can be obtained by increasing their intensity beyond 2 000 or 3 000 cd. In an endeavour to increase the range at which lights would first be sighted at night, their intensity should not be raised to an extent that a pilot might find excessively dazzling at diminished range.
- (g) From the foregoing should be evident the importance of adjusting the intensity of the lights of an aerodrome lighting system according to the prevailing conditions, so as to obtain the best results without excessive dazzle that would disconcert the pilot. The appropriate intensity setting on any particular occasion should depend both on the conditions of background brightness and the visibility.
- (h) Assessment on dazzle in the aerodrome vicinity:
- (1) Human vision is a complex mechanism using both eye and brain. Even though this mechanism is quite handled for eye, there is still a lack of knowledge on the interpretation of it by the brain. Thus, vision varies from one human being to another.

- (2) The field of view is defined by the area perceived by eyes. The perception of details is based on the luminance ratio between elements of the scene, taking into account spatial distribution. Luminance and contrast are key elements of vision mechanism.
- (3) Four sectors can be identified in the field of view (FOV):
  - (i) sensation field, corresponding to the absolute boundaries of FOV; it opens up to approximately 90° on each side of the eye direction;
  - (ii) visibility field, which is narrower and enables the perception of an object; it opens up to 60°;
  - (iii) conspicuity field, which enables the recognition, it opens up to 30°;
  - (iv) working conspicuity field, which is further tightly centred on the eye direction (1° to 2°); it enables the identification and is the working area of the vision.

It is reminded that the retina is composed in its centre by cone cells (that see colours and details) and at the periphery by rod cells (that perceive movements and change of state).

- (i) A safety assessment is conducted in order to identify situations where the risk of dazzling becomes unacceptable. Thus, it is noted that dazzle represents such a risk in the following situations:
  - (1) during approach, especially after the aircraft has descended below the decision height: the pilot should not lose any visual cue;
  - (2) at touchdown the pilot should not be surprised by a flash;
  - (3) during rolling (landing or take-off), the pilot should be able to perceive his environment and detect any deviation from the centre line: the pilot should not lose any visual cue.
  - (4) Thus:
    - (i) prejudicial dazzle due to veiling luminance should not occur during approach (slightly before the decision height) and rolling; and
    - (ii) surprise effect should not occur at touchdown.
- (j) Regarding air traffic controllers, it has been considered that dazzle induced by veiling effect should not reduce the visual perception of aircraft operations on, and close to the runway.
- (k) The elements here above can be applied to solar panels. The following assumptions can be made:
  - (1) solar panels are inclined so as to efficiently capture the sunlight, conducting to a range of cross section surfaces;
  - (2) the maximum acceptable luminance value has been fixed to 20 000 cd/m<sup>2</sup>; and
  - (3) the surfaces varied from 100 m<sup>2</sup> to several hectares.
- (l) It is assumed that the aircraft maintains precisely its trajectory whereas in reality the approach is conducted into a conical envelop around the expected trajectory.

## CS ADR-DSN.M.620 Aeronautical beacons

ED Decision 2014/013/R

### (a) General

- (1) When operationally necessary an aerodrome beacon or identification beacon should be provided at each aerodrome intended for use at night.
- (2) The operational requirement should be determined having regard to the requirements of the air traffic using the aerodrome, the conspicuity of the aerodrome features in relation to its surroundings, and the installation of other visual and non-visual aids useful in locating the aerodrome.

### (b) Aerodrome beacon

#### (1) Applicability

An aerodrome beacon should be provided at an aerodrome intended for use at night if aircraft navigate predominantly by visual means and one or more of the following conditions exist:

- (i) reduced visibilities are frequent; or
- (ii) it is difficult to locate the aerodrome from the air due to surrounding lights or terrain.

#### (2) Location

- (i) The aerodrome beacon should be located on or adjacent to the aerodrome in an area of low ambient background lighting.
- (ii) The location of the beacon should be such that the beacon is not shielded by objects in significant directions and does not dazzle a pilot approaching to land.

#### (3) Characteristics

- (i) The aerodrome beacon should show either coloured flashes alternating with white flashes or white flashes only.
- (ii) The frequency of total flashes should be from 20 to 30 per minute.
- (iii) The light from the beacon should show at all angles of azimuth. The vertical light distribution should extend upwards from an elevation of not more than 1° to an elevation sufficient to provide guidance at the maximum elevation at which the beacon is intended to be used, and the effective intensity of the flash should be not less than 2 000 cd.
- (iv) At locations where a high ambient background lighting level cannot be avoided, the effective intensity of the flash should be required to be increased by a factor up to a value of 10.

### (c) Identification beacon

#### (1) Applicability

An identification beacon should be provided at an aerodrome which is intended for use at night and cannot be easily identified from the air by other means.

- (2) Location
  - (i) The identification beacon should be located on the aerodrome in an area of low ambient background lighting.
  - (ii) The location of the beacon should be such that the beacon is not shielded by objects in significant directions and does not dazzle a pilot approaching to land.
- (3) Characteristics
  - (i) An identification beacon at a land aerodrome should show at all angles of azimuth. The vertical light distribution should extend upwards from an elevation of not more than 1° to an elevation sufficient to provide guidance at the maximum elevation at which the beacon is intended to be used, and the effective intensity of the flash should be not less than 2 000 cd.
  - (ii) At locations where a high ambient background lighting level cannot be avoided, the effective intensity of the flash should be required to be increased by a factor up to a value of 10.
  - (iii) An identification beacon should show flashing-green.
  - (iv) The identification characters should be transmitted in the International Morse Code.
  - (v) The speed of transmission should be between six and eight words per minute, the corresponding range of duration of the Morse dots being from 0.15 to 0.2 seconds per dot.

## GM1 ADR-DSN.M.620 Aeronautical beacons

ED Decision 2014/013/R

intentionally left blank

## CS ADR-DSN.M.625 Approach lighting systems

ED Decision 2016/027/R

- (a) The safety objective of the approach lighting system is to provide alignment and roll guidance, and limited distance-to-go information to enable safe approach to a runway.
- (b) Non-instrument runway

Applicability: Where physically practicable, a simple approach lighting system as specified in [CS ADR-DSN.M.626](#) should be provided to serve a non-instrument runway where the code number is 3 or 4, and intended for use at night, except when the runway is used only in conditions of good visibility, and sufficient guidance is provided by other visual aids.
- (c) Non-precision approach runway

Applicability: Where physically practicable, a simple approach lighting system specified in [CS ADR-DSN.M.626](#) should be provided to serve a non-precision approach runway, except when the runway is used only in conditions of good visibility or sufficient guidance is provided by other visual aids.



(d) Precision approach runway Category I

Applicability: Where physically practicable, a precision approach Category I lighting system as specified in [CS ADR-DSN.M.630](#) should be provided to serve a precision approach runway Category I.

(e) Precision approach runway Categories II and III

Applicability: A precision approach Category II and III lighting system as specified in [CS ADR-DSN.M.635](#) should be provided to serve a precision approach runway Category II or III.

[Issue: ADR-DSN/3]

## GM1 ADR-DSN.M.625 Approach lighting systems

ED Decision 2017/021/R

(a) Types and characteristics

- (1) The approach lighting patterns that have been generally adopted are shown in Figures M-1 and M-2. A diagram of the inner 300 m of the precision approach Category II and III lighting system is shown in Figures M-3A and M-3B.
- (2) The approach lighting configuration is to be provided irrespective of the location of the threshold, i.e. whether the threshold is at the extremity of the runway or displaced from the runway extremity. In both cases, the approach lighting system should extend up to the threshold. However, in the case of a displaced threshold, inset lights are used from the runway extremity up to the threshold to obtain the specified configuration. These inset lights are designed to satisfy the structural requirements specified in [CS ADR.DSN.M.615\(d\)\(1\)](#). The characteristics of these inset lights should be in accordance with the specifications in [CS ADR-DSN.U.940](#), Figures U-5 or U-6, as appropriate and the chromaticity should be in accordance with the specifications in [CS ADR-DSN.U.930](#) and Figure U-1A or U-1B, as appropriate.
- (3) Examples of flight path envelopes used in designing the lighting are shown in Figure GM-M-2.

(b) Horizontal installation tolerances:

- (1) The dimensional tolerances are shown in Figure M-1 and M-2.
- (2) The centre line of an approach lighting system should be as coincident as possible with the extended centre line of the runway with a maximum tolerance of  $\pm 15'$ .
- (3) The longitudinal spacing of the centre line lights should be such that one light (or group of lights) is located in the centre of each crossbar, and the intervening centre line lights are spaced as evenly as practicable, between two crossbars or a crossbar and a threshold.
- (4) The crossbars and barrettes should be at right angles to the centre line of the approach lighting system with a tolerance of  $\pm 30'$  if the pattern in Figure M-2(A) is adopted or  $\pm 2^\circ$  if Figure M-2(B) is adopted.
- (5) When a crossbar has to be displaced from its standard position, any adjacent crossbar should where possible, be displaced by appropriate amounts in order to reduce the differences in the crossbar spacing.
- (6) When a crossbar in the system shown in Figure M-2(A) is displaced from its standard position, its overall length should be adjusted so that it remains one-twentieth of the actual distance of the crossbar from the point of origin. It is not necessary, however, to

adjust the standard 2.7 m spacing between the crossbar lights but the crossbars should be kept symmetrical about the centre line of the approach lighting.

(c) Vertical installation tolerances:

- (1) The ideal arrangement is to mount all the approach lights in the horizontal plane passing through the threshold as shown in Figure GM-M-1, and this should be the general aim as far as local conditions permit. However, buildings, trees, etc. should not obscure the lights from the view of a pilot who is assumed to be 1° below the electronic glide path in the vicinity of the outer marker.
- (2) Within a stopway or clearway, and within 150 m of the end of a runway, the lights should be mounted as near to the ground as local conditions permit in order to minimise risk of damage to aeroplanes in the event of an overrun or undershoot. Beyond the stopway and clearway, it is not so necessary for the lights to be mounted close to the ground, and, therefore, undulations in the ground contours can be compensated for by mounting the lights on poles of appropriate height.
- (3) It is desirable that the lights be mounted so that as far as possible, no object within a distance of 60 m on each side of the centre line protrudes through the plane of the approach lighting system. Where a tall object exists within 60 m of the centre line and within 1 350 m from the threshold for a precision approach lighting system, or 900 m for a simple approach lighting system, it may be advisable to install the lights so that the plane of the outer half of the pattern clears the top of the object.
- (4) In order to avoid giving a misleading impression of the plane of the ground, the lights should not be mounted below a gradient of 1 in 66 downwards from the threshold to a point 300 m out, and below a gradient of 1 in 40 beyond the 300 m point. For a precision approach Category II and III lighting system, more stringent criteria may be necessary, e.g. negative slopes not permitted within 450 m of the threshold.
  - (i) Centre line. The gradients of the centre line in any section (including a stopway or clearway) should be as small as practicable, and the changes in gradients should be as few and small as can be arranged, and should not exceed 1 in 60. Experience has shown that as one proceeds outwards from the runway, rising gradients in any section of up to 1 in 66, and falling gradients of down to 1 in 40, are acceptable.
  - (ii) Crossbars. The crossbar lights should be so arranged as to lie on a straight line passing through the associated centre line lights, and wherever possible, this line should be horizontal. It is permissible, however, to mount the lights on a transverse gradient not more than 1 in 80 if this enables crossbar lights within a stopway or clearway to be mounted nearer to the ground on sites where there is a cross-fall.
- (5) When the barrette is composed of lights approximating to point sources, a spacing of 1.5 m between adjacent lights in the barrette has been found satisfactory.
- (6) At locations where identification of the simple approach lighting system is difficult at night due to surrounding lights, sequence flashing lights installed in the outer portion of the system may resolve this problem.

(d) Clearance of obstacles:

- (1) An area, hereinafter referred to as the light plane, has been established for obstacle clearance purposes, and all lights of the system are in this plane. This plane is rectangular in shape and symmetrically located about the approach lighting system's centre line. It

starts at the threshold and extends 60 m beyond the approach end of the system, and is 120 m wide.

- (2) No objects are permitted to exist within the boundaries of the light plane which are higher than the light plane except as designated herein. All roads and highways are considered as obstacles extending 4.8 m above the crown of the road, except aerodrome service roads where all vehicular traffic is under control of the aerodrome operator and coordinated with the aerodrome air traffic control. Railroads, regardless of the amount of traffic, are considered as obstacles extending 5.4 m above the top of the rails.
- (3) It is recognised that some components of electronic landing aids systems, such as reflectors, antennas, monitors, etc. should be installed above the light plane. Every effort should be made to relocate such components outside the boundaries of the light plane. In the case of reflectors and monitors, this can be done in many instances.
- (4) Where an ILS localiser is installed within the light plane boundaries, it is recognised that the localiser, or screen if used, should extend above the light plane. In such cases, the height of these structures should be held to a minimum and they should be located as far from the threshold as possible. In general, the rule regarding permissible heights is 15 cm for each 30 m the structure is located from the threshold. As an example, if the localiser is located 300 m from the threshold, the screen should be permitted to extend above the plane of the approach lighting system by  $10 \times 15 = 150$  cm maximum but preferably should be kept as low as possible, consistent with proper operation of the ILS.
- (5) In locating an MLS azimuth antenna the guidance contained in ICAO Annex 10, Volume I, Attachment G, should be followed. This material which also provides guidance on collocating an MLS azimuth antenna with an ILS localiser antenna, suggests that the MLS azimuth antenna may be sited within the light plane boundaries where it is not possible or practical to locate it beyond the outer end of the approach lighting for the opposite direction of approach. If the MLS azimuth antenna is located on the extended centre line of the runway, it should be as far as possible from the closest light position to the MLS azimuth antenna in the direction of the runway end. Furthermore, the MLS azimuth antenna phase centre should be at least 0.3 m above the light centre of the light position closest to the MLS azimuth antenna in the direction of the runway end. (This could be relaxed to 0.15 m if the site is otherwise free of significant multipath problems.)
- (6) Compliance with this requirement which is intended to ensure that the MLS signal quality is not affected by the approach lighting system, could result in the partial obstruction of the lighting system by the MLS azimuth antenna. To ensure that the resulting obstruction does not degrade visual guidance beyond an acceptable level, the MLS azimuth antenna should not be located closer to the runway end than 300 m and the preferred location is 25 m beyond the 300 m crossbar (this would place the antenna 5 m behind the light position 330 m from the runway end). Where an MLS azimuth antenna is so located, a central part of the 300 m crossbar of the approach lighting system would alone be partially obstructed. Nevertheless, it is important to ensure that the unobstructed lights of the crossbar remain serviceable all the time.
- (7) Objects existing within the boundaries of the light plane, requiring the light plane to be raised in order to meet the criteria contained herein, should be removed, lowered, or relocated where this can be accomplished more economically than raising the light plane.
- (8) In some instances objects may exist which cannot be removed, lowered, or relocated economically. These objects may be located so close to the threshold that they cannot be cleared by the 2 % slope. Where such conditions exist and no alternative is possible, the

2 % slope may be exceeded or a 'stair step' resorted to in order to keep the approach lights above the objects. Such 'step' or increased gradients should be resorted to only when it is impracticable to follow standard slope criteria, and they should be held to the absolute minimum. Under this criterion no negative slope is permitted in the outermost portion of the system.

- (e) Consideration of the effects of reduced lengths:
- (1) The need for an adequate approach lighting system to support precision approaches where the pilot is required to acquire visual references prior to landing, cannot be stressed too strongly. The safety and regularity of such operations is dependent on this visual acquisition. The height above runway threshold at which the pilot decides there are sufficient visual cues to continue the precision approach and land, should vary, depending on the type of approach being conducted and other factors such as meteorological conditions, ground and airborne equipment, etc. The required length of approach lighting system which should support all the variations of such approaches is 900 m, and this should always be provided whenever possible.
  - (2) However, there are some runway locations where it is impossible to provide the 900 m length of approach lighting system to support precision approaches.
  - (3) In such cases, every effort should be made to provide as much approach lighting system as possible. Restrictions on operations could be imposed on runways equipped with reduced lengths of approach lighting. There are many factors which determine at what height the pilot should have decided to continue the approach to land or execute a missed approach. It should be understood that the pilot does not make an instantaneous judgement upon reaching a specified height. The actual decision to continue the approach and landing sequence is an accumulative process which is only concluded at the specified height. Unless lights are available prior to reaching the decision point, the visual assessment process is impaired and the likelihood of missed approaches should increase substantially. There are many operational considerations which should be taken into account in deciding if any restrictions are necessary to any precision approach and these are detailed in ICAO Annex 6.
- (f) For non-precision approach runways it is advisable to give consideration to the installation of a precision approach Category I lighting system or to the addition of a runway lead-in lighting system.

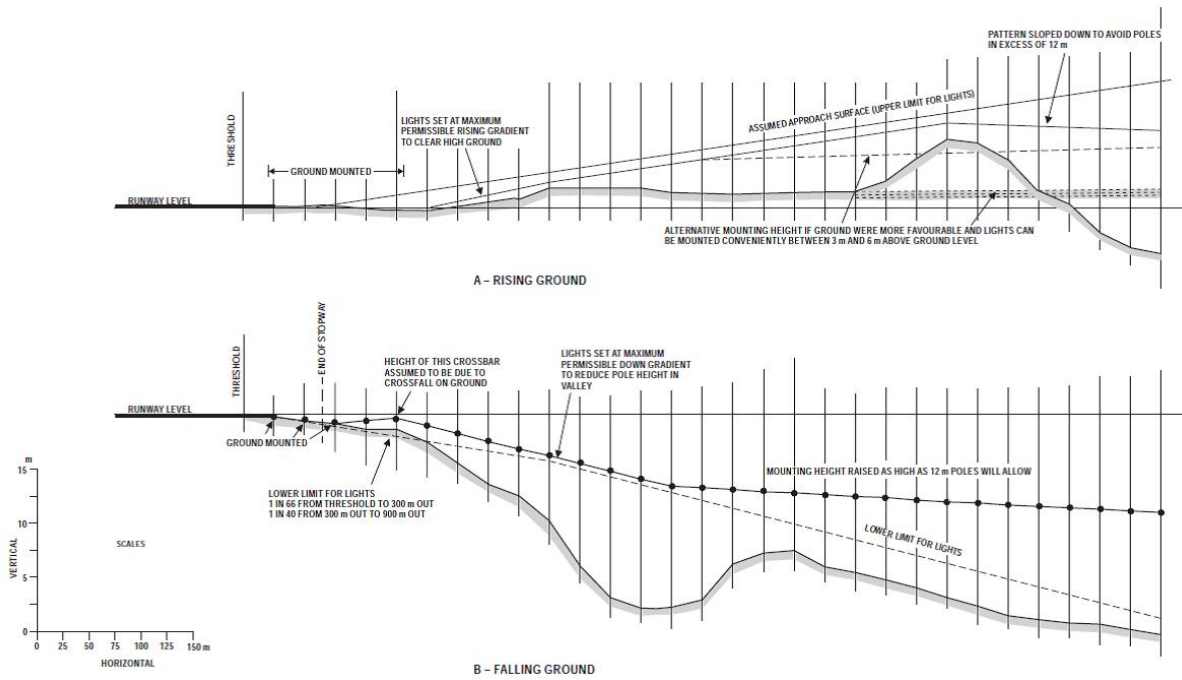


Figure GM-M-1. Vertical installation tolerances

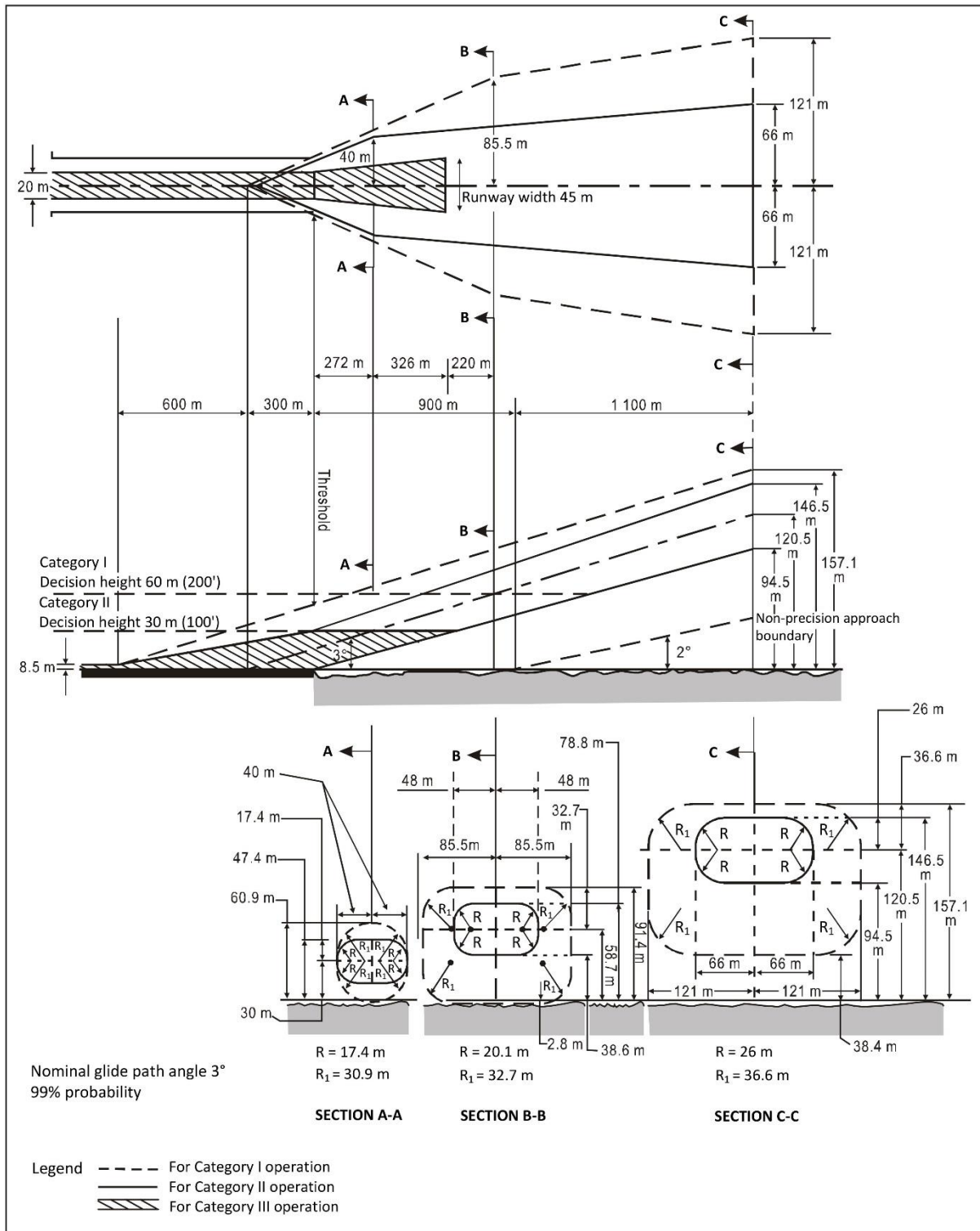


Figure GM-M-2. Flight path envelope examples for lighting design for Category I, II and III operations — Centre line lights

[Issue: ADR-DSN/3]

[Issue: ADR-DSN/4]

## CS ADR-DSN.M.626 Simple approach lighting systems

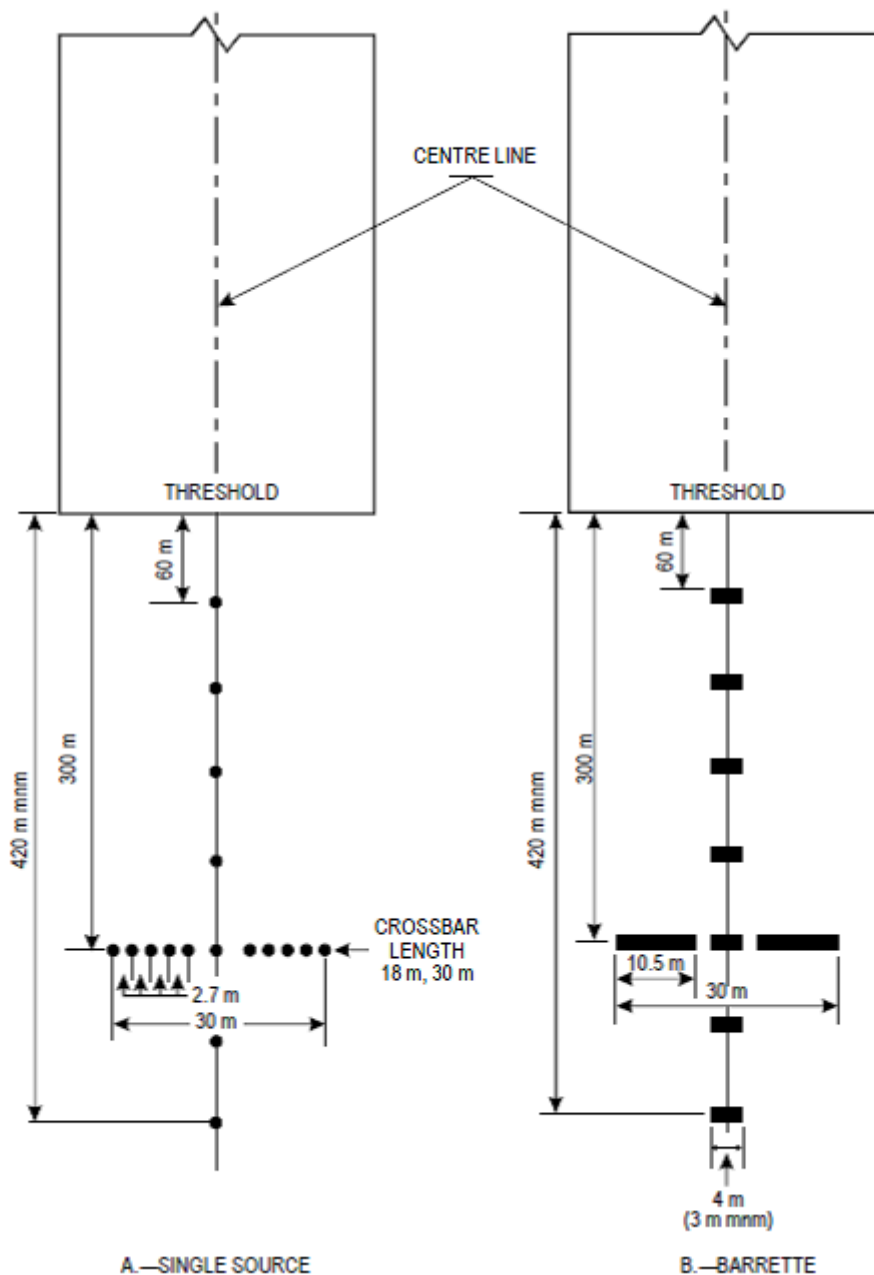
ED Decision 2021/004/R

- (a) Location and composition:
- (1) A simple approach lighting system should consist of a row of lights on the extended centre line of the runway extending, whenever possible, over a distance of not less than 420 m from the threshold with a row of lights forming a crossbar 18 m or 30 m in length at a distance of 300 m from the threshold (see Figure M-1).
  - (2) The certification specifications provide for the basic characteristics for simple approach lighting systems. For certain aspects of these systems, some latitude is permitted; for example, in the spacing between centre line lights and crossbar.
- (b) Crossbar lights:
- (1) The lights forming the crossbar should be as close as practicable in a horizontal straight line at right angles to, and bisected by, the line of the centre line lights.
  - (2) The lights of the crossbar should be spaced so as to produce a linear effect, except that, when a crossbar of 30 m is used, gaps may be left on each side of the centre line. These gaps should be kept to a minimum to meet local requirements, and each should not exceed 6 m.
  - (3) Spacing for the crossbar lights between 1 m and 4 m are in use. Gaps on each side of the centre line may improve directional guidance when approaches are made with a lateral error, and facilitate the movement of rescue and firefighting vehicles.
- (c) Centre line lights:
- (1) The lights forming the centre line should be placed at longitudinal intervals of 60 m, except that when it is desired to improve the guidance, an interval of 30 m may be used.
  - (2) The innermost light should be located either 60 m or 30 m from the threshold, depending on the longitudinal interval selected for the centre line lights. If it is not physically possible to provide a centre line extending for a distance of 420 m from the threshold, it should be extended to 300 m so as to include the crossbar. If this is not possible, the centre line lights should be extended as far as practicable, and each centre line light should then consist of a barrette at least 3 m in length. Subject to the approach system having a crossbar at 300 m from the threshold, an additional crossbar may be provided at 150 m from the threshold.
  - (3) The system should lie as nearly as practicable in the horizontal plane passing through the threshold, provided that:
    - (i) no object other than an ILS or MLS azimuth antenna should protrude through the plane of the approach lights within a distance of 60 m from the centre line of the system; and
    - (ii) no light other than a light located within the central part of a crossbar or a centre line barrette, excluding their extremities, should be screened from an approaching aircraft.

Any ILS or MLS azimuth antenna protruding through the plane of the lights should be treated as an obstacle, and marked and lighted accordingly as specified in the requirements for obstacle marking and lighting.

- 
- (d) Characteristics:
- (1) The lights of a simple approach lighting system should be fixed lights and the colour of the lights should be such as to ensure that the system is readily distinguishable from other aeronautical ground lights, and from extraneous lighting if present, but should be preferably fixed lights showing variable white. Each centre line light should consist of either:
    - (i) a single source; or
    - (ii) a barrette at least 3 m in length.
  - (e) Barrettes of 4 m in length should be so designed if it is anticipated that the simple approach lighting system should be developed into a precision approach lighting system.
  - (f) Where provided for a non-instrument runway, the lights should show at all angles in azimuth necessary to a pilot on base leg and final approach. The intensity of the lights should be adequate for all conditions of visibility and ambient light for which the system has been provided.
  - (g) Where provided for a non-precision approach runway, the lights should show at all angles in azimuth necessary to the pilot of an aircraft which on final approach does not deviate by an abnormal amount from the path defined by the non-visual aid. The lights should be designed to provide guidance during both day and night in the most adverse conditions of visibility and ambient light for which it is intended that the system should remain usable.





**Figure M-1. Simple approach lighting systems**

[Issue: ADR-DSN/3]  
 [Issue: ADR-DSN/5]

## GM1 ADR-DSN.M.626 Simple approach lighting systems

ED Decision 2014/013/R

intentionally left blank

## CS ADR-DSN.M.630 Precision approach Category I lighting system

ED Decision 2021/004/R

- (a) The safety objective of the approach lighting system is to provide alignment and roll guidance, and limited distance-to-go information to enable safe approach to a runway.
- (b) Location and composition
- (1) General: A precision approach Category I lighting system should consist of a row of lights on the extended centre line of the runway extending wherever possible, over a distance of 900 m from the runway threshold with a row of lights forming a crossbar 30 m in length at a distance of 300 m from the runway threshold (see Figure M-2).
  - (2) Crossbar lights: The lights forming the crossbar should be as close as practicable in a horizontal straight line at right angles to, and bisected by, the line of the centre line lights. The lights of the crossbar should be spaced so as to produce a linear effect, except that gaps may be left on each side of the centre line. These gaps should be kept to a minimum to meet local requirements and each should not exceed 6 m.
  - (3) Centre line lights: The lights forming the centre line should be placed at longitudinal intervals of 30 m with the innermost light located 30 m from the threshold.
  - (4) The system should lie as nearly as practicable in the horizontal plane passing through the threshold, provided that:
    - (i) no object other than an ILS or MLS azimuth antenna should protrude through the plane of the approach lights within a distance of 60 m from the centre line of the system; and
    - (ii) no light other than a light located within the central part of a crossbar or a centre line barrette (not their extremities) should be screened from an approaching aircraft.
    - (iii) Any ILS or MLS azimuth antenna protruding through the plane of the lights should be treated as an obstacle and marked and lighted accordingly.
- (c) Characteristics:
- (1) The centre line and crossbar lights of a precision approach Category I lighting system should be fixed lights showing variable white. Each centre line light position should consist of either:
    - (i) a single light source in the innermost 300 m of the centre line, two light sources in the central 300 m of the centre line, and three light sources in the outer 300 m of the centre line to provide distance information; or
    - (ii) a barrette.
  - (2) Where the serviceability level of the approach lights specified as a maintenance objective in [ADR.OPS.C.015](#) can be demonstrated, each centre line light position should consist of:
    - (i) a single light source; or
    - (ii) a barrette.

When barrettes are composed of lights approximating to point sources, the lights should be uniformly spaced at intervals of not more than 1.5 m. The barrettes should be at least 4 m in length.

- (3) If the centre line consists of lights as described in paragraph (c)(1)(i) or (c)(2)(i) above, additional crossbars of lights to the crossbar provided at 300 m from the threshold should be provided at 150 m, 450 m, 600 m and 750 m from the threshold. The lights forming each crossbar should be as nearly as practicable in a horizontal straight line at right angles to, and bisected by, the line of the centre line lights. The lights should be spaced so as to produce a linear effect, except that gaps may be left on each side of the centre line. These gaps should be kept to a minimum to meet local requirements and each should not exceed 6 m.
- (4) Where the additional crossbars are incorporated in the system, the outer ends of the crossbars should lie on two straight lines that either are parallel to the line of the centre line lights or converge to meet the runway centre line 300 m upwind from threshold.
- (5) The characteristics of lights should be in accordance with the specifications in [CS ADR-DSN.U.940](#), Figure U-5. The chromaticity of lights should be in accordance with the specifications in [CS ADR-DSN.U.930](#) and Figure U-1A or U-1B, as appropriate.
- (6) If the centre line consists of barrettes as described in paragraph (c)(1)(ii) or (c)(2)(ii) above, each barrette should be supplemented by a flashing light, except where such lighting is considered unnecessary taking into account the characteristics of the system, and the nature of the meteorological conditions.
- (7) Each flashing light, as described in paragraph (c)(6), should be flashed twice a second in sequence, beginning with the outermost light and progressing toward the threshold to the innermost light of the system. The design of the electrical circuit should be such that these lights can be operated independently of the other lights of the approach lighting system.

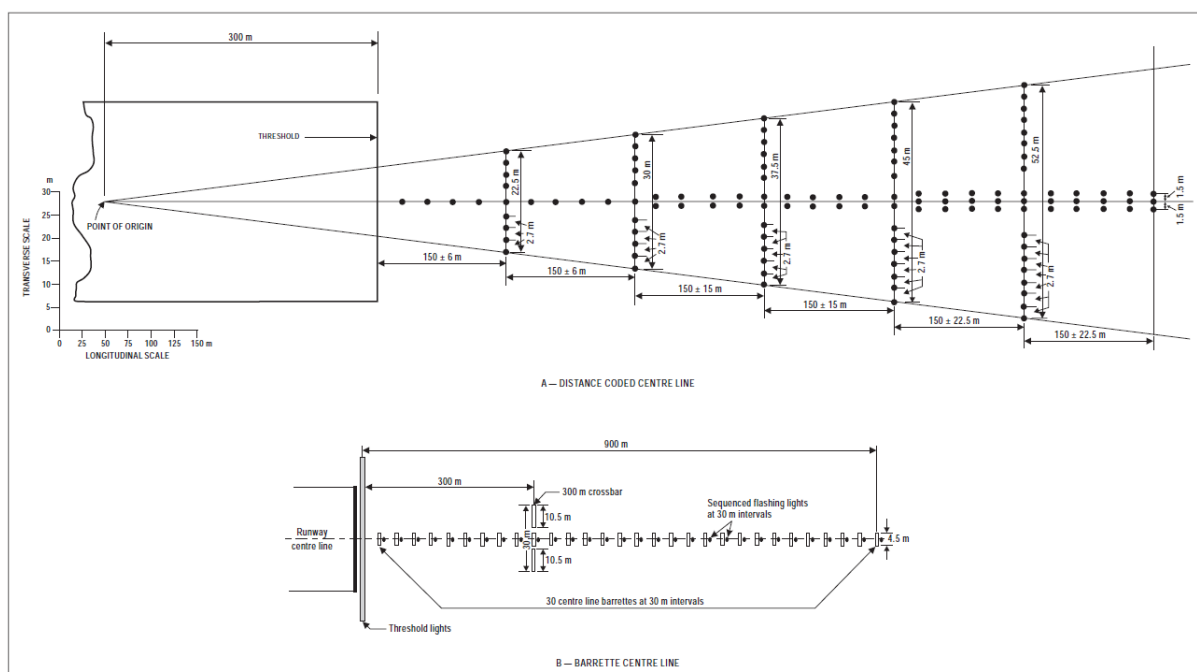


Figure M-2. Precision approach Category I lighting systems

[Issue: ADR-DSN/3]

[Issue: ADR-DSN/4]

[Issue: ADR-DSN/5]

## GM1 ADR-DSN.M.630 Precision approach Category I lighting system

ED Decision 2017/021/R

- (a) The installation of an approach lighting system of less than 900 m in length may result in operational limitations on the use of the runway.
- (b) Spacings for the crossbar lights between 1 m and 4 m are in use. Gaps on each side of the centre line may improve directional guidance when approaches are made with a lateral error, and facilitate the movement of rescue and firefighting vehicles.
- (c) The flashing light system provides a long-distance information about the location and orientation of an active runway to the approaching pilots. Particularly in the surrounding of cities with urban lighting of streets, places and buildings, the flashing light system allows a clear identification of the approach by the flight crew. To prevent glare at night and have clear visibility, the high-intensity flashing light should be provided with an appropriate intensity control.

[Issue: ADR-DSN/3]

[Issue: ADR-DSN/4]

## CS ADR-DSN.M.635 Precision approach Category II and III lighting system

ED Decision 2021/004/R

- (a) Location and composition:
  - (1) The approach lighting system should consist of a row of lights on the extended centre line of the runway, extending, wherever possible, over a distance of 900 m from the runway threshold. In addition, the system should have two side rows of lights, extending 270 m from the threshold, and two crossbars, one at 150 m and one at 300 m from the threshold, all as shown in Figure M-3A. Where the serviceability level of the approach lights specified as maintenance objectives in [ADR.OPS.C.015](#) can be demonstrated, the system may have two side rows of lights extending 240 m from the threshold, and two crossbars, one at 150 m, and one at 300 m from the threshold, all as shown in Figure M-3B.
  - (2) The lights forming the centre line should be placed at longitudinal intervals of 30 m with the innermost lights located 30 m from the threshold.
  - (3) The lights forming the side rows should be placed on each side of the centre line, at a longitudinal spacing equal to that of the centre line lights and with the first light located 30 m from the threshold. Where the serviceability level of the approach lights specified as maintenance objectives can be demonstrated, lights forming the side rows may be placed on each side of the centre line, at a longitudinal spacing of 60 m with the first light located 60 m from the threshold. The lateral spacing (or gauge) between the innermost lights of the side rows should be not less than 18 m nor more than 22.5 m, and preferably 18 m, but in any event should be equal to that of the touchdown zone lights.
  - (4) The crossbar provided at 150 m from the threshold should fill in the gaps between the centre line and side row lights.
  - (5) The crossbar provided at 300 m from the threshold should extend on both sides of the centre line lights to a distance of 15 m from the centre line.

- (6) If the centre line beyond a distance of 300 m from the threshold consists of lights as described in paragraphs (b)(2)(ii) and (b)(3)(ii) below, additional crossbars of lights should be provided at 450 m, 600 m and 750 m from the threshold. Where such additional crossbars are incorporated in the system, the outer ends of these crossbars should lie on two straight lines that either are parallel to the centre line or converge to meet the runway centre line 300 m from the threshold.
- (7) The system should lie as nearly as practicable in the horizontal plane passing through the threshold, provided that:
- (i) no object other than an ILS or MLS azimuth antenna should protrude through the plane of the approach lights within a distance of 60 m from the centre line of the system; and
  - (ii) no light other than a light located within the central part of a crossbar or a centre line barrette (not their extremities) should be screened from an approaching aircraft.
  - (iii) Any ILS or MLS azimuth antenna protruding through the plane of the lights should be treated as an obstacle and marked and lighted accordingly.
- (b) Characteristics:
- (1) The centre line of a precision approach Category II and III lighting system for the first 300 m from the threshold should consist of barrettes showing variable white, except that where the threshold is displaced 300 m or more, the centre line may consist of single light sources showing variable white. Where the serviceability level of the approach lights specified in [ADR.OPS.C.015](#) can be demonstrated, the centre line of a precision approach Category II and III lighting system for the first 300 m from the threshold may consist of:
- (i) barrettes where the centre line beyond 300 m from the threshold consists of barrettes as described in paragraph (b)(3)(i) below; or
  - (ii) alternate single light sources and barrettes, where the centre line beyond 300 m from the threshold consists of single light sources as described in paragraph (b)(3)(ii) below, with the innermost single light source located 30 m and the innermost barrette located 60 m from the threshold; or
  - (iii) single light sources where the threshold is displaced 300 m or more;
- all of which should show variable white.
- (2) Beyond 300 m from the threshold each centre line light position should consist of either:
- (i) a barrette as used on the inner 300 m; or
  - (ii) two light sources in the central 300 m of the centre line, and three light sources in the outer 300 m of the centre line;
- all of which should show variable white.
- (3) Where the serviceability level of the approach lights in [ADR.OPS.C.015](#) as maintenance objectives can be demonstrated beyond 300 m from the threshold, each centre line light position may consist of either:
- (i) a barrette; or
  - (ii) a single light source;
- all of which should show variable white.

- (4) The barrettes should be at least 4 m in length. When barrettes are composed of lights approximating to point sources, the lights should be uniformly spaced at intervals of not more than 1.5 m.
- (5) If the centre line beyond 300 m from the threshold consists of barrettes as described in paragraphs (b)(2)(i) and (b)(3)(i), each barrette beyond 300 m should be supplemented by a flashing light, except where such lighting is considered unnecessary taking into account the characteristics of the system and the nature of the meteorological conditions.
- (6) Each flashing light should be flashed twice a second in sequence, beginning with the outermost light and progressing toward the threshold to the innermost light of the system. The design of the electrical circuit should be such that these lights can be operated independently of the other lights of the approach lighting system.
- (7) The side row should consist of barrettes showing red. The length of a side row barrette and the spacing of its lights should be equal to those of the touchdown zone light barrettes.
- (8) The lights forming the crossbars should be fixed lights showing variable white. The lights should be uniformly spaced at intervals of not more than 2.7 m.
- (9) The intensity of the red lights should be compatible with the intensity of the white lights.
- (10) The characteristics of lights should be in accordance with the specifications in [CS ADR-DSN.U.940](#), Figures U-5 or U-6, as appropriate.
- (11) The chromaticity of lights should be in accordance with the specifications in [CS ADR-DSN.U.930](#) and Figure U-1A or U-1B, as appropriate.

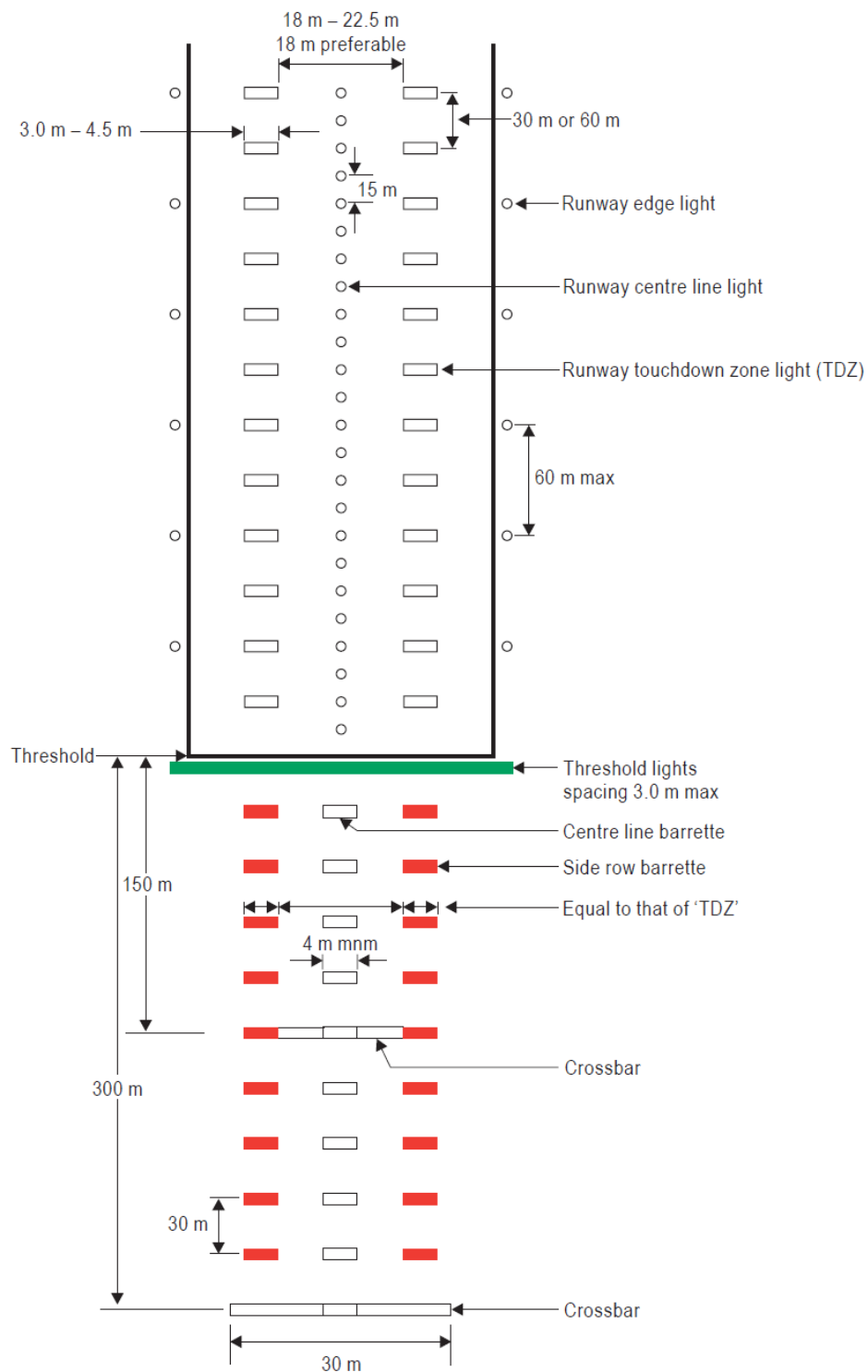


Figure M-3A. Inner 300 m approach and runway lighting for precision approach runways, Categories II and III

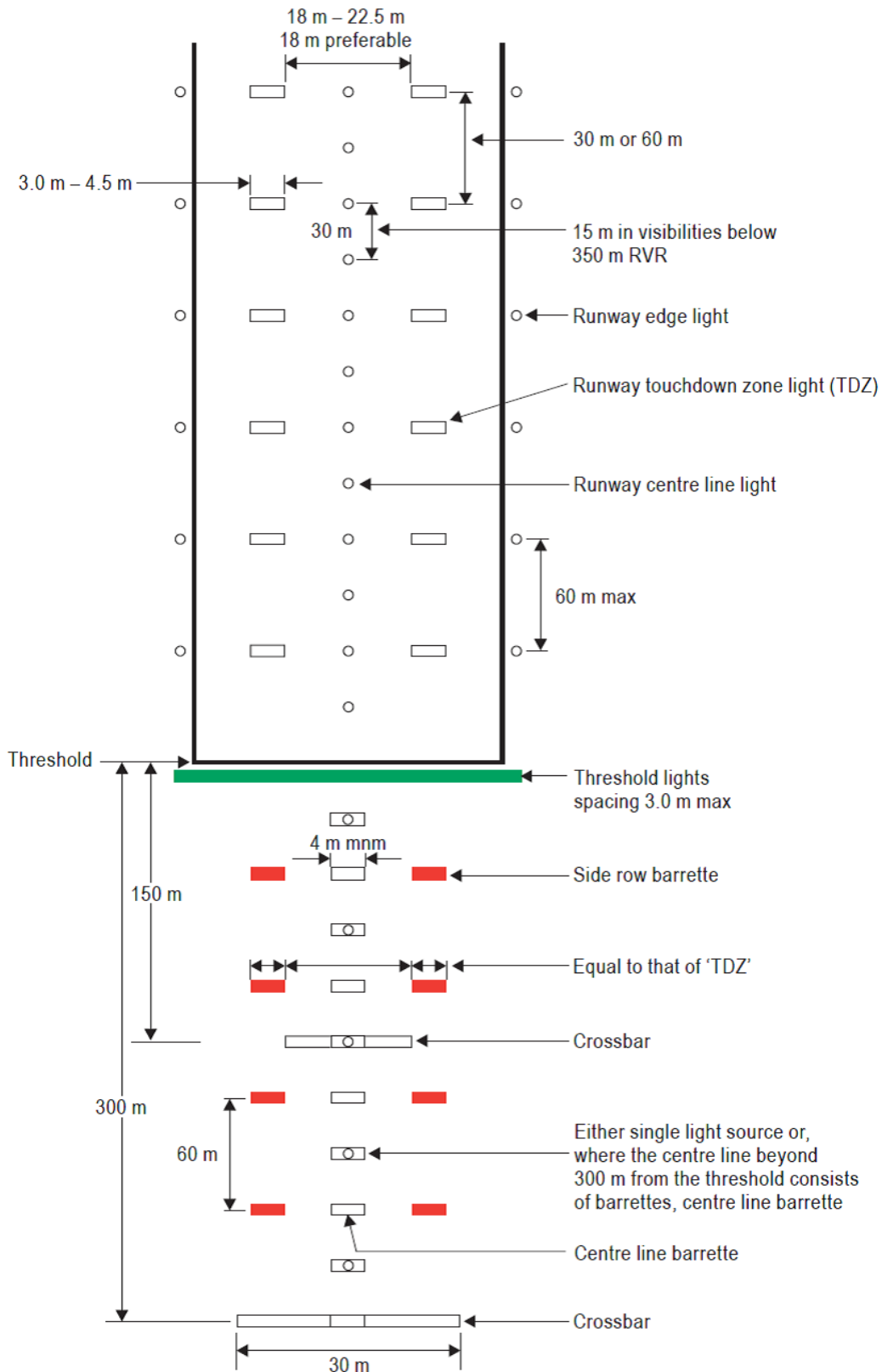


Figure M-3B. Inner 300 m approach and runway lighting for precision approach runways, Categories II and III, where the serviceability levels of the lights specified as maintenance objectives in ADR.OPS.C.015(b)(1) to (3) can be demonstrated.

[Issue: ADR-DSN/3]

[Issue: ADR-DSN/4]



[Issue: ADR-DSN/5]

## GM1 ADR-DSN.M.635 Precision approach Category II and III lighting system

*ED Decision 2016/027/R*

The length of 900 m is based on providing guidance for operations under Category I, II and III conditions. Reduced lengths may support Category II and III operations but may impose limitations on Category I operations. Additional guidance is given in ICAO Annex 14, Attachment A, Section 11.

[Issue: ADR-DSN/3]

## CS ADR-DSN.M.640 Visual approach slope indicator systems

*ED Decision 2014/013/R*

The safety objective of visual approach slope indicators is to provide information on the approach angle necessary to maintain a safe height over obstacles and threshold.

- (a) A visual approach slope indicator system should be provided to serve the approach to a runway where one or more of the following conditions exist:
  - (1) the runway is used by turbojet or other aeroplanes with similar approach guidance requirements;
  - (2) the pilot of any type of aeroplane may have difficulty in judging the approach due to:
    - (i) inadequate visual guidance such as is experienced during an approach over water or featureless terrain by day or in the absence of sufficient extraneous lights in the approach area by night; or
    - (ii) misleading information such as is produced by deceptive surrounding terrain or runway slopes.
  - (3) the presence of objects in the approach area may involve serious hazard if an aeroplane descends below the normal approach path, particularly if there are no non-visual or other visual aids to give warning of such objects;
  - (4) physical conditions at either end of the runway present a serious hazard in the event of an aeroplane undershooting or overrunning the runway; and
  - (5) terrain or prevalent meteorological conditions are such that the aeroplane may be subjected to unusual turbulence during approach.
- (b) The standard visual approach slope indicator systems should consist of PAPI and APAPI systems conforming to the specifications, as prescribed in [CS ADR-DSN.M.645](#) to [CS ADR-DSN.M.655](#).
- (c) PAPI should be provided where the code number is 3 or 4 when one or more of the conditions specified in paragraph (a) above exist.
- (d) PAPI or APAPI should be provided where the code number is 1 or 2 when one or more of the conditions specified in paragraph (a) above exist.

## GM1 ADR-DSN.M.640 Visual approach slope indicator systems

*ED Decision 2014/013/R*

- (a) Factors that should be considered when making a decision on which runway on an aerodrome should receive first priority for the installation of a visual approach slope indicator system are:

- (1) frequency of use;
  - (2) seriousness of the hazard;
  - (3) presence of other visual and non-visual aids;
  - (4) type of aeroplanes using the runway; and
  - (5) frequency and type of adverse weather conditions under which the runway should be used.
- (b) With respect to the seriousness of the hazard, the order given in the [CS ADR-DSN.M.640](#) may be used as a general guide. These may be summarised as:
- (1) inadequate visual guidance because of:
    - (i) approaches over water or featureless terrain, or absence of sufficient extraneous light in the approach area by night;
    - (ii) deceptive surrounding terrain.
  - (2) serious hazard in approach;
  - (3) serious hazard if aeroplanes undershoot or overrun; and
  - (4) unusual turbulence.
- (c) The presence of other visual or non-visual aids is a very important factor. Runways equipped with ILS or MLS would generally receive the lowest priority for a visual approach slope indicator system installation. It should be remembered, though, that visual approach slope indicator systems are visual approach aids in their own right and can supplement electronic aids. When serious hazards exist and/or a substantial number of aeroplanes not equipped for ILS or MLS use a runway, priority might be given to installing a visual approach slope indicator on this runway.
- (d) Priority may be given to runways used by turbojet aeroplanes.
- (e) Where a runway threshold is temporarily displaced from the normal position and one or more of the conditions specified in paragraph (a) above exist, a PAPI should be provided except that where the code number is 1 or 2 either an APAPI may be provided.

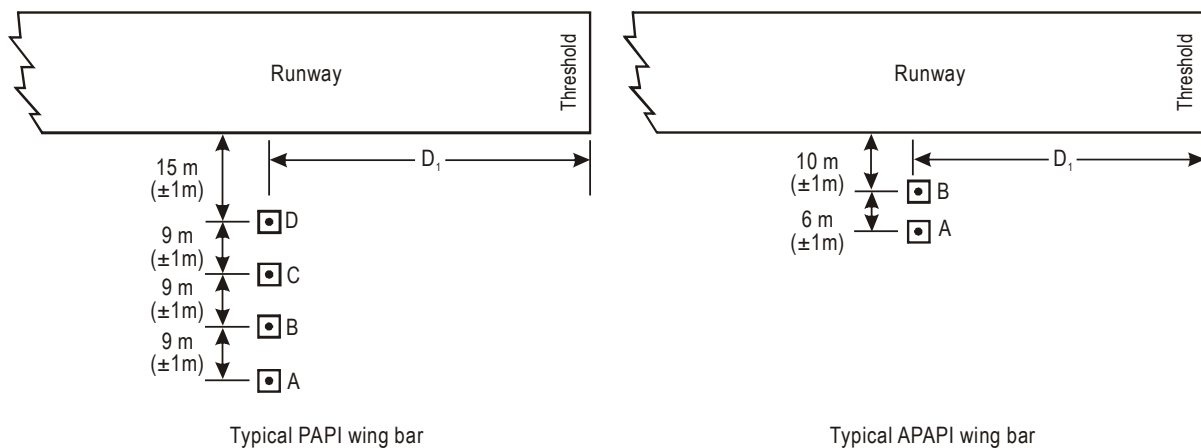
## **CS ADR-DSN.M.645 Precision approach path indicator and Abbreviated precision approach path indicator (PAPI and APAPI)**

*ED Decision 2017/021/R*

- (a) A PAPI or APAPI should be in accordance with the specifications provided in paragraphs [CS ADR-DSN.M.645](#) to [CS ADR-DSN.M.655](#).
- (b) Definition and positioning:
  - (1) The PAPI system should consist of a wing bar of four sharp transition multi-lamp (or paired single lamp) units equally spaced. The APAPI system should consist of a wing bar of two sharp transition multi-lamp (or paired single lamp) units. The PAPI and APAPI system should be located on the left side of the runway unless it is physically impracticable to do so. Where a runway is used by aircraft requiring visual roll guidance which is not provided by other external means, then a second wing bar may be provided on the opposite side of the runway for PAPI or APAPI.

- (2) The wing bar of a PAPI should be constructed and arranged in such a manner that a pilot making an approach should:
    - (i) when on or close to the approach slope, see the two units nearest the runway as red and the two units farthest from the runway as white;
    - (ii) when above the approach slope, see the one unit nearest the runway as red and the three units farthest from the runway as white; and when further above the approach slope, see all the units as white; and
    - (iii) when below the approach slope, see the three units nearest the runway as red and the unit farthest from the runway as white; and when further below the approach slope, see all the units as red.
  - (3) The wing bar of an APAPI should be constructed and arranged in such a manner that a pilot making an approach should:
    - (i) when on or close to the approach slope, see the unit nearer the runway as red and the unit farther from the runway as white;
    - (ii) when above the approach slope, see both the units as white; and
    - (iii) when below the approach slope, see both the units as red.
  - (4) The light units should be located as in the basic configuration illustrated in Figure M-4, subject to the installation tolerances given below. The units forming a wing bar should be mounted so as to appear to the pilot of an approaching aeroplane to be substantially in a horizontal line. The light units should be mounted as low as possible and should be frangible.
- (c) Characteristics:
- (1) The system should be suitable for both day and night operations.
  - (2) Colour:
    - (i) The colour transition from red to white in the vertical plane should be such as to appear to an observer, at a distance of not less than 300 m, to occur within a vertical angle of not more than 3°.
    - (ii) At full intensity, the chromaticity of lights units should be in accordance with the specifications in [CS ADR-DSN.U.930](#) and Figure U-1A or U-1B, as appropriate, and the red light should have a Y coordinate not exceeding 0.320.
  - (3) Intensity:
    - (i) The light intensity distribution of the light units should be as shown in [CS ADR-DSN.U.940](#), Figure U-26.
    - (ii) Suitable intensity control should be provided so as to allow adjustment to meet the prevailing conditions and to avoid dazzling the pilot during approach and landing.
  - (4) Light orientation: Each light unit should be capable of adjustment in elevation so that the lower limit of the white part of the beam may be fixed at any desired angle of elevation between 1°30' and at least 4°30' above the horizontal.
  - (5) Other characteristics: The light units should be so designed that deposits of condensation, snow, ice, dirt, or other contaminants, on optically transmitting or reflecting surfaces

should interfere to the least possible extent with the light signals and should not affect the contrast between the red and white signals and the elevation of the transition sector.



### INSTALLATION TOLERANCES

- a) Where a PAPI or APAPI is installed on a runway not equipped with an ILS or MLS, the distance  $D_1$  should be calculated to ensure that the lowest height at which a pilot will see a correct approach path indication (Figure M-5, angle B for a PAPI and angle A for an APAPI) provides the wheel clearance over the threshold specified in Table M-1 for the most demanding amongst aeroplanes regularly using the runway.
- b) Where a PAPI or APAPI is installed on a runway equipped with an ILS and/or MLS, the distance  $D_1$  should be calculated to provide the optimum compatibility between the visual and non-visual aids for the range of eye-to-antenna heights of the aeroplanes regularly using the runway. The distance should be equal to that between the threshold and the effective origin of the ILS glide path or MLS minimum glide path, as appropriate, plus a correction factor for the variation of eye-to-antenna heights of the aeroplanes concerned. The correction factor is obtained by multiplying the average eye-to-antenna height of those aeroplanes by the cotangent of the approach angle. However, the distance should be such that in no case will the wheel clearance over the threshold be lower than that specified in column (3) of Table M-1.  
Note: See [CS ADR-DSN.L.540](#) for specifications on aiming point marking. Further guidance on the harmonisation of PAPI, ILS and/or MLS signals is contained in ICAO Doc 9157, Aerodrome Design Manual, Part 4, Visual Aids.
- c) If a wheel clearance, greater than that specified in a) above is required for specific aircraft, this can be achieved by increasing  $D_1$ .
- d) Distance  $D_1$  should be adjusted to compensate for differences in elevation between the lens centres of the light units and the threshold.
- e) To ensure that units are mounted as low as possible and to allow for any transverse slope, small height adjustments of up to 5 cm between units are acceptable. A lateral gradient not greater than 1.25 per cent can be accepted provided it is uniformly applied across the units.
- f) A spacing of 6 m ( $\pm 1$  m) between PAPI units should be used on code numbers 1 and 2. In such an event, the inner PAPI unit should be located not less than 10 m ( $\pm 1$  m) from the runway edge.  
Note: Reducing the spacing between light units results in a reduction in usable range of the system.
- g) The lateral spacing between APAPI units may be increased to 9 m ( $\pm 1$  m) if greater range is required or later conversion to a full PAPI is anticipated. In the latter case, the inner APAPI unit should be located 15 m ( $\pm 1$  m) from the runway edge.

Figure M-4. Siting of PAPI and APAPI

[Issue: ADR-DSN/3]

[Issue: ADR-DSN/4]

## GM1 ADR-DSN.M.645 Precision approach path indicator and Abbreviated precision approach path indicator (PAPI and APAPI)

ED Decision 2016/027/R

intentionally left blank

[Issue: ADR-DSN/3]

## CS ADR-DSN.M.650 Approach slope and elevation setting of light units for PAPI and APAPI

ED Decision 2016/027/R

- (a) Approach slope:
- (1) The approach slope as defined in Figure M-5, should be so designed to be appropriate for use by the aeroplanes in the approach.
  - (2) When the runway is equipped with an ILS and/or MLS, the siting and the angle of elevation of the light units should be such that the visual approach slope conforms as closely as possible with the glide path of the ILS and/or the minimum glide path of the MLS, as appropriate.
- (b) Elevation setting of light units
- (1) The angle of elevation settings of the light units in a PAPI wing bar should be such that, during an approach, the pilot of an aeroplane observing a signal of one white and three reds should clear all objects in the approach area by a safe margin (see Table M-1).
  - (2) The angle of elevation settings of the light units in an APAPI wing bar should be such that, during an approach, the pilot of an aeroplane observing the lowest on-slope signal, i.e. one white and one red, should clear all objects in the approach area by a safe margin (see Table M-1).
  - (3) The azimuth spread of the light beam should be suitably restricted where an object located outside the obstacle protection surface of the PAPI or APAPI system but within the lateral limits of its light beam, is found to extend above the plane of the obstacle protection surface and a safety assessment indicates that the object could adversely affect the safety of operations. The extent of the restriction should be such that the object remains outside the confines of the light beam.
  - (4) Where wing bars are installed on each side of the runway to provide roll guidance, corresponding units should be set at the same angle so that the signals of each wing bar change symmetrically at the same time.

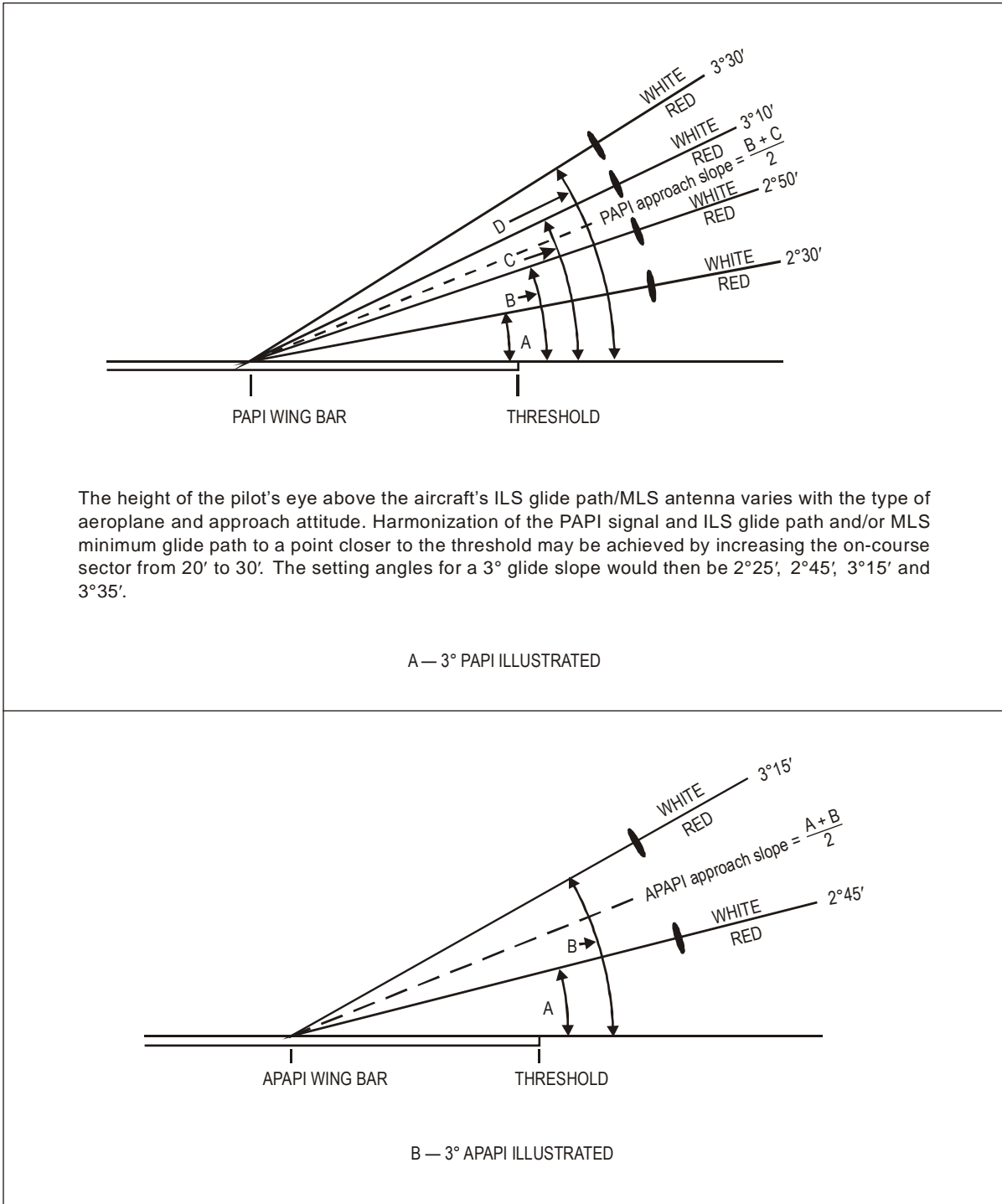


Figure M-5. Light beams and angle of elevation setting of PAPI and APAPI

[Issue: ADR-DSN/3]

## GM1 ADR-DSN.M.650 Approach slope and elevation setting of light units for PAPI and APAPI

ED Decision 2016/027/R

intentionally left blank

[Issue: ADR-DSN/3]

## CS ADR-DSN.M.655 Obstacle protection surface for PAPI and APAPI

ED Decision 2017/021/R

(a) Applicability:

An obstacle protection surface should be established when it is intended to provide a visual approach slope indicator system.

(b) Characteristics:

The characteristics of the obstacle protection surface, i.e. origin, divergence, length, and slope should correspond to those specified in the relevant column of Table M-2 and in Figure M-6.

(c) New objects or extensions of existing objects should not be permitted above an obstacle protection surface except when the new object or extension would be shielded by an existing immovable object, or if after a safety assessment, it is determined that the object would not adversely affect the safety of operations of aeroplanes.

(d) Where a safety assessment indicates that an existing object extending above an obstacle protection surface could adversely affect the safety of operations of aeroplanes one or more of the following measures should be taken:

- (1) remove the object;
- (2) suitably raise the approach slope of the system;
- (3) reduce the azimuth spread of the system so that the object is outside the confines of the beam;
- (4) displace the axis of the system and its associated obstacle protection surface by no more than 5°;
- (5) suitably displace the threshold; and
- (6) where (5) is found to be impracticable, suitably displace the system upwind of the threshold such that the object no longer penetrates the obstacle protection surface.

Eye-to-wheel height of aeroplane in the approach configuration <sup>a</sup>	Desired wheel clearance (metres) <sup>b, c</sup>	Minimum wheel clearance (metres) <sup>d</sup>
(1)	(2)	(3)
up to but not including 3 m	6	3 <sup>e</sup>
3 m up to but not including 5 m	9	4
5 m up to but not including 8 m	9	5
8 m up to but not including 14 m	9	6

- a. In selecting the eye-to-wheel height group, only aeroplanes meant to use the system on a regular basis should be considered. The most demanding amongst such aircrafts should determine the eye-to-wheel height group.
- b. Where practicable, the desired wheel clearances shown in column (2) should be provided.
- c. The wheel clearances in column (2) should be reduced to no less than those in column (3) where an safety assessment indicates that such reduced wheel clearances are acceptable.
- d. When a reduced wheel clearance is provided at a displaced threshold, it should be ensured that the corresponding desired wheel clearance specified in column (2) should be available when an aeroplane at the top end of the eye-to-wheel height group chosen overflies the extremity of the runway.
- e. This wheel clearance should be reduced to 1.5 m on runways used mainly by light-weight non-turbo-jet aeroplanes.

Table M-1. Wheel clearance over threshold for PAPI and APAPI

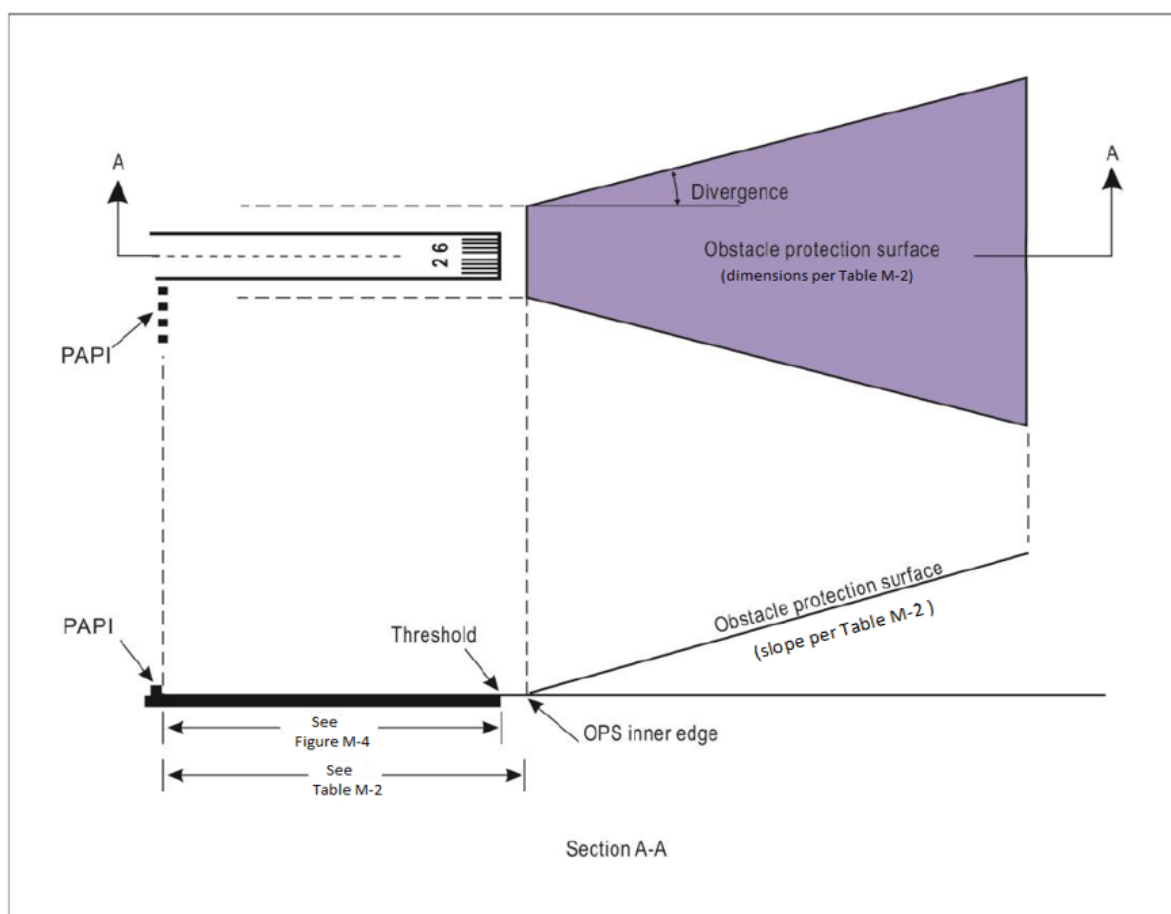
Surface dimensions	Runway type/code number							
	Non-instrument				Instrument			
	Code number				Code number			
	1	2	3	4	1	2	3	4
Length of inner edge	60 m	80 m	150 m	150 m	150 m	150 m	300 m	300 m
Distance from the visual approach slope indicator system <sup>2</sup>	D <sub>1</sub> +30 m	D <sub>1</sub> +60 m	D <sub>1</sub> +60 m	D <sub>1</sub> +60 m	D <sub>1</sub> +60 m	D <sub>1</sub> +60 m	D <sub>1</sub> +60 m	D <sub>1</sub> +60 m
Divergence (each side)	10 %	10 %	10 %	10 %	15 %	15 %	15 %	15 %
Total length	7 500 m	7 500 m	15 000 m	15 000 m	7 500 m	7 500 m	15 000 m	15 000 m
a) PAPI <sup>1</sup>	—	A-0.57°	A-0.57°	A-0.57°	A-0.57°	A-0.57°	A-0.57°	A-0.57°
b) APAPI <sup>1</sup>	A-0.9°	A-0.9°	—	—	A-0.9°	A-0.9°	—	—

<sup>1</sup> Angles as indicated in Figure M-5.

<sup>2</sup> D<sub>1</sub> is the distance of the visual approach slope indicator system from threshold prior to any displacement to remedy object penetration of the obstacle protection surface (refer to Figure M-4). The start of the obstacle protection surface is fixed to the visual approach slope indicator system location, such that displacement of the PAPI results in an equal displacement of the start of the obstacle protection surface.

**Table M-2. Dimensions and slopes of the obstacle protection surface**





**Figure M-6. Obstacle protection surface for visual approach slope indicator systems**

[Issue: ADR-DSN/3]

[Issue: ADR-DSN/4]

## GM1 ADR-DSN.M.655 Obstacle protection surface for PAPI and APAPI

*ED Decision 2017/021/R*

- (a) The displacement of the system upwind of the threshold reduces the operational landing distance.
- (b) Additional guidance on the calculation for siting PAPI/ APAPI on a runway with ILS/MLS is given in ICAO Doc 9157, Aerodrome Design Manual, Part 4, Visual Aids.

[Issue: ADR-DSN/4]

## CS ADR-DSN.M.660 Circling guidance lights

*ED Decision 2016/027/R*

- (a) Applicability: Circling guidance lights should be provided when existing approach and runway lighting systems do not satisfactorily permit identification of the runway and/or approach area to a circling aircraft intending to carry out circling approaches.

- (b) Location and positioning:
- (1) The location and number of circling guidance lights should be adequate to enable a pilot, as appropriate, to:
    - (i) join the downwind leg or align and adjust the aircraft's track to the runway at a required distance from it and to distinguish the threshold in passing; and
    - (ii) keep in sight the runway threshold and/or other features which should make it possible to judge the turn on to base leg and final approach, taking into account the guidance provided by other visual aids.
  - (2) Circling guidance lights should consist of:
    - (i) lights indicating the extended centre line of the runway and/or parts of any approach lighting system; or
    - (ii) lights indicating the position of the runway threshold; or
    - (iii) lights indicating the direction or location of the runway;or a combination of such lights as is appropriate to the runway under consideration.
- (c) Characteristics:
- (1) Circling guidance lights should be fixed or flashing lights of an intensity and beam spread adequate for the conditions of visibility and ambient light in which it is intended to make visual circling approaches. The flashing lights should be white, and the steady lights either white or gaseous discharge lights.
  - (2) The lights should be designed and be installed in such a manner that they should not dazzle or confuse a pilot when approaching to land, taking off, or taxiing.

[Issue: ADR-DSN/3]

## GM1 ADR-DSN.M.660 Circling guidance lights

*ED Decision 2014/013/R*

intentionally left blank

## CS ADR-DSN.M.665 Runway lead-in lighting systems

*ED Decision 2017/021/R*

- (a) Applicability: A runway lead-in lighting system should be provided to avoid hazardous terrain.
- (b) Location and positioning
- (1) A runway lead-in lighting system should consist of groups of lights positioned:
    - (i) so as to define the desired approach path. Runway lead-in lighting systems may be curved, straight, or a combination thereof; and
    - (ii) so that one group should be sighted from the preceding group.
  - (2) The interval between adjacent groups should not exceed approximately 1 600 m.
  - (3) A runway lead-in lighting system should extend from a determined point up to a point where the approach lighting system if provided, or the runway lighting system is in view.

- (4) Each group of lights of a runway lead-in lighting system should consist of at least three flashing lights in a linear or cluster configuration. The system should be augmented by steady burning lights where such lights would assist in identifying the system.
  - (c) Characteristics: The flashing lights and the steady burning lights should be white.
- [Issue: ADR-DSN/4]

## GM1 ADR-DSN.M.665 Runway lead-in lighting systems

*ED Decision 2014/013/R*

- (a) Applicability: A runway lead-in lighting system may be provided for purposes of noise abatement routing.
- (b) Characteristics:
  - (1) Where practicable, the flashing lights in each group should flash in sequence towards the runway.
  - (2) The path of the system may be segmented, straight, or a combination thereof, as required.
  - (3) The starting point of the path may be at a point within easy visual range of a final approach fix.

## CS ADR-DSN.M.670 Runway threshold identification lights

*ED Decision 2017/021/R*

- (a) Applicability:
  - (1) The inclusion of specifications for runway threshold identification lights is not intended to imply that the runway threshold identification lights have to be provided at an aerodrome.
  - (2) Where provided, runway threshold identification lights should be installed:
    - (i) at the threshold of a non-precision approach runway when additional threshold conspicuity is necessary or where it is not practicable to provide other approach lighting aids; and
    - (ii) where a runway threshold is permanently displaced from the runway extremity or temporarily displaced from the normal position and additional threshold conspicuity is necessary.
- (b) Location: Runway threshold identification lights should be located symmetrically about the runway centre line, in line with the threshold and approximately 10 m outside each line of runway edge lights.
- (c) Characteristics:
  - (1) Runway threshold identification lights should be flashing white lights with a flash frequency between 60 and 120 per minute;
  - (2) The lights should be visible only in the direction of approach to the runway.

[Issue: ADR-DSN/4]

## GM1 ADR-DSN.M.670 Runway threshold identification lights

*ED Decision 2017/021/R*

intentionally left blank

[Issue: ADR-DSN/4]

## CS ADR-DSN.M.675 Runway edge lights

*ED Decision 2017/021/R*

- (a) Applicability:
- (1) Runway edge lights should be provided for a runway intended for use at night or for a precision approach runway intended for use by day or night.
  - (2) Runway edge lights should be provided on a runway intended for take-off with an operating minimum below an RVR of the order of 800 m by day.
- (b) Location and positioning:
- (1) Runway edge lights should be placed along the full length of the runway and should be in two parallel rows equidistant from the centre line.
  - (2) Runway edge lights should be placed along the edges of the area declared for use as the runway or outside the edges of the area at a distance of not more than 3 m.
  - (3) Where the width of the area which could be declared as runway, exceeds 60 m, the distance between the rows of lights should be determined taking into account the nature of the operations, the light distribution characteristics of the runway edge lights, and other visual aids serving the runway.
  - (4) The lights should be uniformly spaced in rows at intervals of not more than 60 m for an instrument runway, and at intervals of not more than 100 m for a non-instrument runway. The lights on opposite sides of the runway axis should be on lines at right angles to that axis. At intersections of runways, lights may be spaced irregularly or omitted, provided that adequate guidance remains available to the pilot.
- (c) Characteristics:
- (1) Runway edge lights should be fixed lights showing variable white, except that:
    - (i) in the case of a displaced threshold, the lights between the beginning of the runway and the displaced threshold should show red in the approach direction; and
    - (ii) a section of the lights 600 m or one-third of the runway length, whichever is the less, at the remote end of the runway from the end at which the take-off run is started, should show yellow.
  - (2) The runway edge lights should show at all angles in azimuth necessary to provide guidance to a pilot landing or taking off in either direction. When the runway edge lights are intended to provide circling guidance, they should show at all angles in azimuth.
- (d) In all angles of azimuth, as prescribed in paragraph (c)(2) above, runway edge lights should show at angles up to 15° above the horizontal with intensity adequate for the conditions of visibility and ambient light in which use of the runway for take-off or landing is intended. In any case, the intensity should be at least 50 cd except that at an aerodrome without extraneous lighting the intensity of the lights may be reduced to not less than 25 cd to avoid dazzling the pilot.

- (e) Runway edge lights characteristics on a precision approach runway should be in accordance with the specifications in [CS ADR-DSN.U.940](#), Figure U-13 or Figure U-14, as appropriate.
- (f) The chromaticity of lights should be in accordance with the specifications in [CS ADR-DSN.U.930](#) and in Figure U-1A or U-1B, as appropriate.

[Issue: ADR-DSN/3]

[Issue: ADR-DSN/4]

## GM1 ADR-DSN.M.675 Runway edge lights

ED Decision 2014/013/R

intentionally left blank

## CS ADR-DSN.M.680 Runway threshold and wing bar lights

ED Decision 2017/021/R

- (a) Applicability of runway threshold: Runway threshold lights should be provided for a runway equipped with runway edge lights, except on a non-instrument or non-precision approach runway where the threshold is displaced and wing bar lights are provided.
- (b) Location and positioning of runway threshold:
  - (1) When a threshold is at the extremity of a runway, the threshold lights should be placed in a row at right angles to the runway axis as near to the extremity of the runway as possible and, in any case, not more than 3 m outside the extremity.
  - (2) When a threshold is displaced from the extremity of a runway, threshold lights should be placed in a row at right angles to the runway axis at the displaced threshold.
  - (3) Threshold lighting should consist of:
    - (i) on a non-instrument or non-precision approach runway, at least six lights;
    - (ii) on a precision approach runway Category I, at least the number of lights that would be required if the lights were uniformly spaced at intervals of 3 m between the rows of runway edge lights; and
    - (iii) on a precision approach runway Category II or III, lights uniformly spaced between the rows of runway edge lights at intervals of not more than 3 m.
  - (4) The lights prescribed in paragraphs (b)(3)(i) and (b)(3)(ii) above should be either:
    - (i) equally spaced between the rows of runway edge lights, or
    - (ii) symmetrically disposed about the runway centre line in two groups, with the lights uniformly spaced in each group and with a gap between the groups equal to the gauge of the touchdown zone marking or lighting, where such is provided, or otherwise not more than half the distance between the rows of runway edge lights.
- (c) Applicability of wing bar lights:
  - (1) Wing bar lights should be provided on a precision approach runway when additional conspicuity is considered desirable.
  - (2) Wing bar lights should be provided on a non-instrument or non-precision approach runway where the threshold is displaced and runway threshold lights are required, but are not provided.

- (d) Location and positioning of wing bar lights: Wing bar lights should be symmetrically disposed about the runway centre line at the threshold in two groups, i.e. wing bars. Each wing bar should be formed by at least five lights extending at least 10 m outward from, and at right angles to, the line of the runway edge lights, with the innermost light of each wing bar in the line of the runway edge lights.
- (e) Characteristics of runway threshold and wing bar lights:
- (1) Runway threshold and wing bar lights should be fixed unidirectional lights showing green in the direction of approach to the runway. The intensity and beam spread of the lights should be adequate for the conditions of visibility and ambient light in which use of the runway is intended.
  - (2) Runway threshold lights on a precision approach runway should be in accordance with the specifications in [CS ADR-DSN.U.940](#), Figure U-7.
  - (3) Threshold wing bar lights on a precision approach runway should be in accordance with the specifications in [CS ADR-DSN.U.940](#), Figure U-8.
  - (4) The chromaticity of lights should be in accordance with the specifications in [CS ADR-DSN.U.930](#) and Figure U-1A or U-1B, as appropriate.

[Issue: ADR-DSN/3]

[Issue: ADR-DSN/4]

## GM1 ADR-DSN.M.680 Runway threshold and wing bar lights

ED Decision 2014/013/R

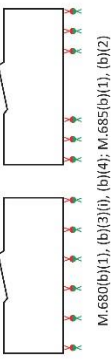

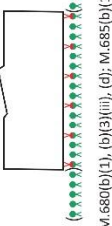
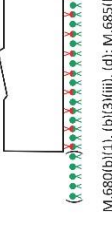
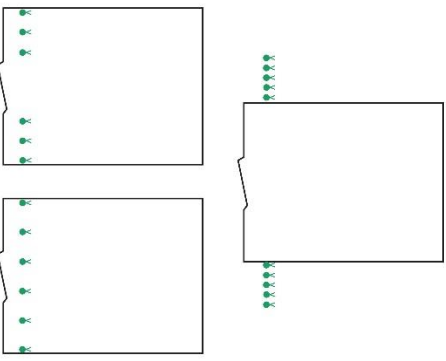
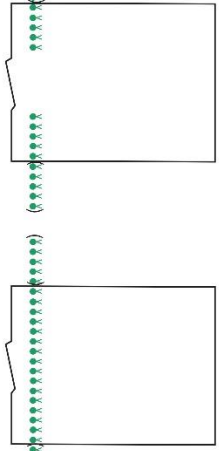
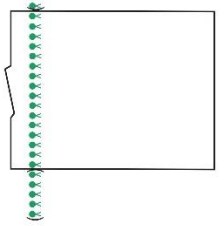
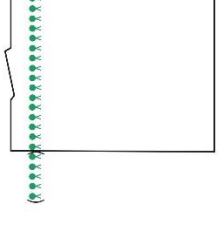
intentionally left blank

## CS ADR-DSN.M.685 Runway end lights

ED Decision 2017/021/R

- (a) Applicability: Runway end lights should be provided for a runway equipped with runway edge lights.
- (b) Location and positioning:
- (1) Runway end lights should be placed on a line at right angles to the runway axis as near to the end of the runway as possible and, in any case, not more than 3 m outside the end.
  - (2) Runway end lighting should consist of at least six lights. The lights should be either:
    - (i) equally spaced between the rows of runway edge lights; or
    - (ii) symmetrically disposed about the runway centre line in two groups with the lights uniformly spaced in each group and with a gap between the groups of not more than half the distance between the rows of runway edge lights.
  - (3) For a precision approach runway Category III, the spacing between runway end lights, except between the two innermost lights if a gap is used, should not exceed 6 m.
- (c) Characteristics of runway end lights:
- (1) Runway end lights should be fixed unidirectional lights showing red in the direction of the runway. The intensity and beam spread of the lights should be adequate for the conditions of visibility and ambient light in which use of the runway is intended.

- (2) Runway end lights characteristics on a precision approach runway should be in accordance with the specifications in [CS ADR-DSN.U.940](#), Figure U-12.
- (3) Runway end lights on a precision approach runway should be in accordance with the chromaticity specifications in [CS ADR-DSN.U.930](#) and Figure U-1A or U-1B, as appropriate.

CONDITION	LIGHTS	NON-INSTRUMENT AND NON-PRECISION APPROACH RUNWAYS	PRECISION APPROACH RUNWAYS CATEGORY I	PRECISION APPROACH RUNWAYS CATEGORY II	PRECISION APPROACH RUNWAYS CATEGORY III
THRESHOLD AT RUNWAY EXTREMITY	RUNWAY THRESHOLD AND RUNWAY END LIGHTS	 <p>M.680(b)(1), (b)(3)(i), (b)(4), M.685(b)(1), (b)(2)</p>	 <p>M.680(b)(1), (b)(3)(ii), (b)(4), (c); M.685(b)(1), (b)(2)</p>	 <p>M.680(b)(1), (b)(3)(iii), (d); M.685(b)(1), (b)(2)</p>	 <p>M.680(b)(1), (b)(3)(iii), (d); M.685(b)(1), (b)(2)</p>
THRESHOLD DISPLACED FROM RUNWAY EXTREMITY	RUNWAY THRESHOLD LIGHTS  RUNWAY END LIGHTS	 <p>M.680(b)(2), (b)(3)(i), (b)(4), M.680(d)</p>	 <p>M.680(b)(2), (b)(3)(ii), (b)(4), (c)</p>	 <p>M.680(b)(2), (b)(3)(iii), (d)</p>	 <p>M.680(b)(2), (b)(3)(iii), (d)</p>

*Note. — The minimum number of lights are shown for a runway 45 m wide with runway edge lights installed at the edge.*

LEGEND





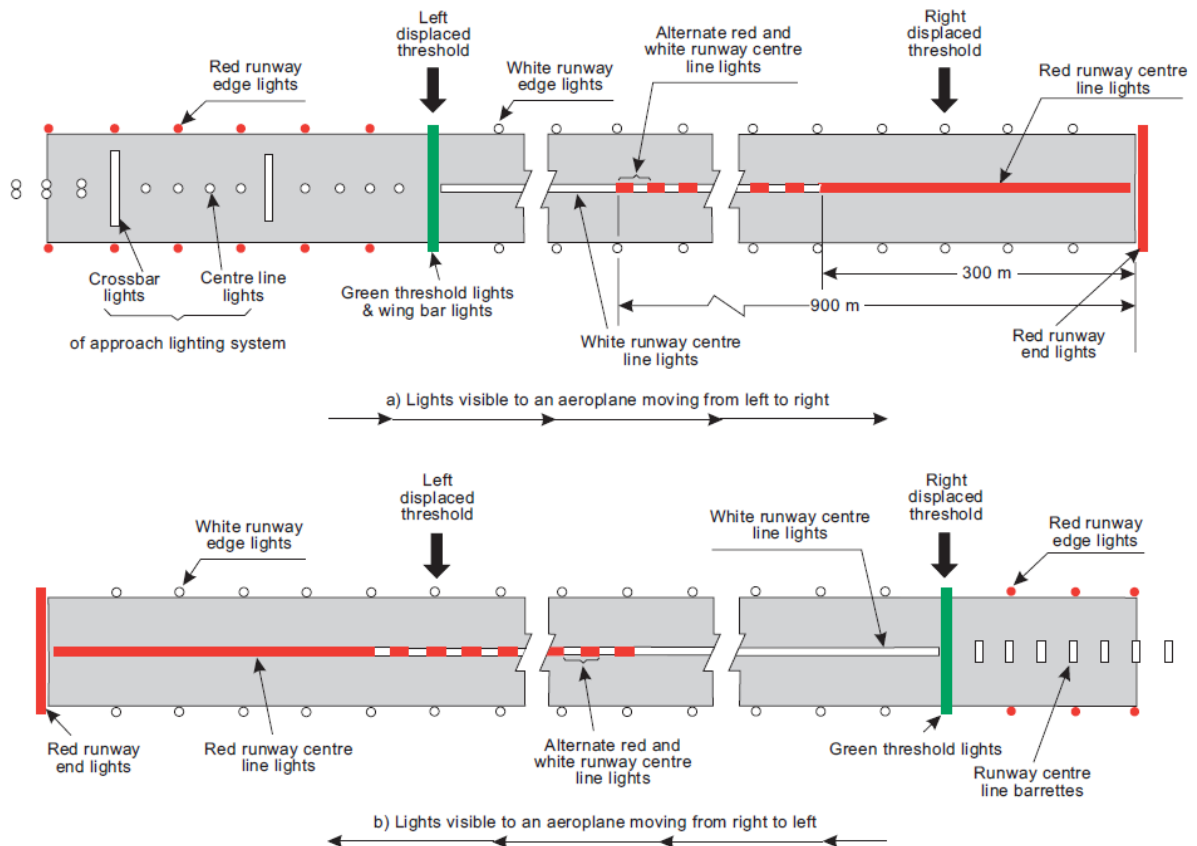
 UNIDIRECTIONAL LIGHT  
 BIDIRECTIONAL LIGHT  
 DISPLACED FROM RUNWAY EXTREMITY  
 ( ) CONDITIONAL RECOMMENDATION

Figure M-7. Arrangement of runway threshold and runway end lights





Example shows lighting on a runway having displaced thresholds at each end and a precision approach category I lighting system serving the left displaced threshold

**Figure M-8. Example of approach and runway lighting for runway with displaced thresholds**

[Issue: ADR-DSN/3]

[Issue: ADR-DSN/4]

## GM1 ADR-DSN.M.685 Runway end lights

ED Decision 2014/013/R

When the threshold is at the runway extremity, fittings serving as threshold lights may be used as runway end lights.

## CS ADR-DSN.M.690 Runway centre line lights

ED Decision 2021/004/R

- (a) The safety objective of runway centre line lights is to facilitate safe take-off and landing in reduced visibility conditions.
- (b) Applicability:
  - (1) Runway centre line lights should be provided on a precision approach runway Category II or III.
  - (2) Runway centre line lights should be provided on a runway intended to be used for take-off with an operating minimum below an RVR of the order of 400 m.

- (c) Location: Runway centre line lights should be located along the centre line of the runway, except that the lights may be uniformly offset to the same side of the runway centre line by not more than 60 cm where it is not practicable to locate them along the centre line. The lights should be located from the threshold to the end at longitudinal spacing of approximately 15 m. Where the serviceability level of the runway centre line lights specified as maintenance objectives in [ADR.OPS.C.015\(b\)\(1\) to \(b\)\(3\)](#) can be demonstrated, and the runway is intended for use in runway visual range conditions of 350 m or greater, the longitudinal spacing may be approximately 30 m.
- (d) Characteristics:
- (1) Runway centre line lights should be fixed lights showing variable white from the threshold to the point 900 m from the runway end; alternate red and variable white from 900 m to 300 m from the runway end; and red from 300 m to the runway end, except that for runways less than 1 800 m in length, the alternate red and variable white lights should extend from the midpoint of the runway usable for landing to 300 m from the runway end.
  - (2) Runway centre line lights characteristics should be in accordance with the specifications in [CS ADR-DSN.U.940](#), Figure U-10 or Figure U-11, as appropriate.
  - (3) Runway centre line lights chromaticity should be in accordance with the specifications in [CS ADR-DSN.U.930](#) and Figure U-1A or U-1B, as appropriate.
- (e) Centre line guidance for take-off from the beginning of a runway to a displaced threshold should be provided by:
- (1) an approach lighting system if its characteristics and intensity settings afford the guidance required during take-off, and it does not dazzle the pilot of an aircraft taking off; or
  - (2) runway centre line lights; or
  - (3) barrettes of at least 3 m length, and spaced at uniform intervals of 30 m, as shown in Figure M-8, designed so that their photometric characteristics and intensity setting afford the guidance required during take-off without dazzling the pilot of an aircraft taking off.

Where necessary, provision should be made to extinguish those centre line lights, as prescribed in paragraph (2) above or reset the intensity of the approach lighting system or barrettes when the runway is being used for landing. In no case should only the single source runway centre line lights show from the beginning of the runway to a displaced threshold when the runway is being used for landing.

[Issue: ADR-DSN/3]

[Issue: ADR-DSN/4]

[Issue: ADR-DSN/5]

## GM1 ADR-DSN.M.690 Runway centre line lights

ED Decision 2017/021/R

- (a) Runway centre line lights should be provided on a precision approach runway Category I when the runway is used by aircraft with high landing speeds or where the width between the runway edge lights is greater than 50 m.
- (b) Runway centre line lights should be provided on a runway intended to be used for take-off with an operating minimum of an RVR of the order of 400 m or higher when used by aeroplanes with

a very high take-off speed where the width between the runway edge lights is greater than 50 m.

- (c) Consideration should be given to providing runway centre line lights where additional conspicuity is required (such as local environment, weather conditions, operational provisions and minima).

[Issue: ADR-DSN/3]

[Issue: ADR-DSN/4]

## CS ADR-DSN.M.695 Runway touchdown zone lights

ED Decision 2017/021/R

- (a) Applicability: Touchdown zone lights should be provided in the touchdown zone of a precision approach runway Category II or III.
- (b) Location and positioning:
- (1) Touchdown zone lights should extend from the threshold for a longitudinal distance of 900 m, except that, on runways less than 1 800 m in length, the system should be shortened so that it does not extend beyond the midpoint of the runway.
  - (2) The pattern should be formed by pairs of barrettes symmetrically located about the runway centre line. The lateral spacing between the innermost lights of a pair of barrettes should be equal to the lateral spacing selected for the touchdown zone marking. The longitudinal spacing between pairs of barrettes should be either 30 m or 60 m.
- (c) Characteristics:
- (1) A barrette should be composed of at least three lights with spacing between the lights of not more than 1.5 m.
  - (2) A barrette should be not less than 3 m or more than 4.5 m in length.
  - (3) Touchdown zone lights should be fixed unidirectional lights showing variable white.
  - (4) Touchdown zone lights characteristics should be in accordance with the specifications in [CS ADR-DSN.U.940](#), Figure U-9.
  - (5) Touchdown zone lights chromaticity should be in accordance with the specifications in [CS ADR-DSN.U.930](#) and Figure U-1A or U-1B, as appropriate.

[Issue: ADR-DSN/3]

[Issue: ADR-DSN/4]

## GM1 ADR-DSN.M.695 Runway touchdown zone lights

ED Decision 2014/013/R

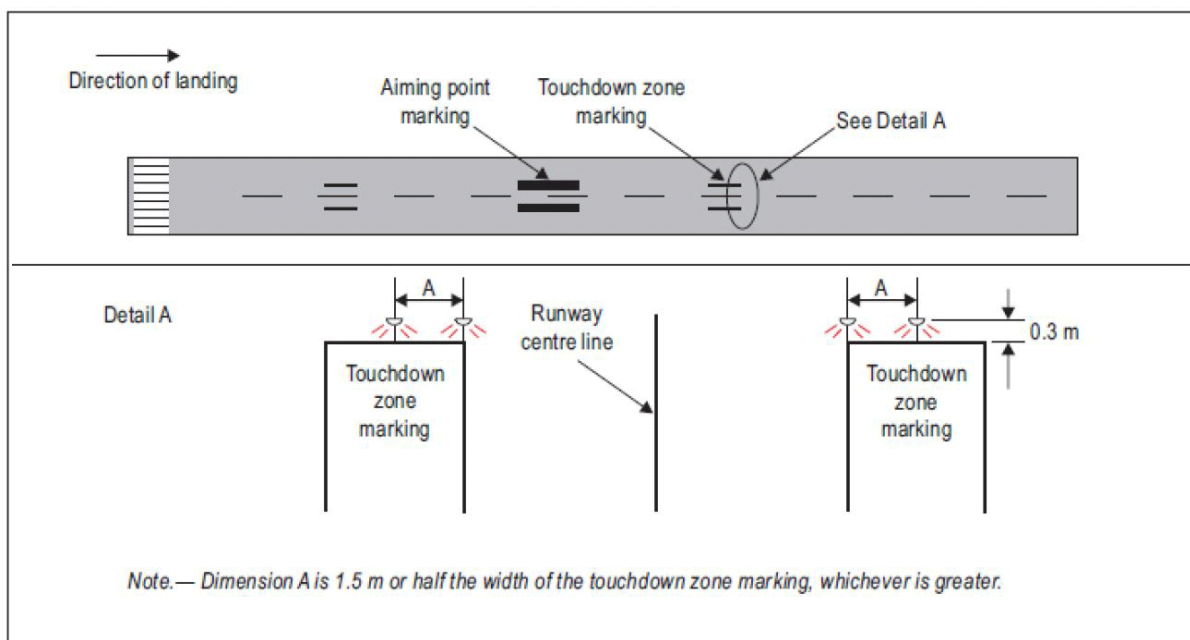
To allow for operations at lower visibility minima, it may be advisable to use a 30 m longitudinal spacing between barrettes.

## CS ADR-DSN.M.696 Simple touchdown zone lights

ED Decision 2017/021/R

- (a) The purpose of simple touchdown zone lights is to provide pilots with enhanced situational awareness in all visibility conditions and to help enable pilots to decide whether to commence a go around if the aircraft has not landed by a certain point on the runway.

- (b) Applicability: Except where touchdown zone lights are provided in accordance with [CS ADR-DSN.M.695](#), at a runway where the approach angle is greater than 3.5 degrees and/or the Landing Distance Available combined with other factors increases the risk of an overrun, simple touchdown zone lights should be provided.
- (c) Location and positioning:
- (1) Simple touchdown zone lights should be a pair of lights located on each side of the runway centre line 0.3 metres beyond the upwind edge of the final touchdown zone marking.
  - (2) The lateral spacing between the inner lights of the two pairs of lights should be equal to the lateral spacing selected for the touchdown zone marking.
  - (3) The spacing between the lights of the same pair should not be more than 1.5 m or half the width of the touchdown zone marking, whichever is greater (see Figure M-8(C)).
  - (4) Where provided on a runway without touchdown zone markings, simple touchdown zone lights should be installed in such a position that provides the equivalent touchdown zone information.
- (d) Characteristics:
- (1) Simple touchdown zone lights should be fixed unidirectional lights showing variable white and aligned so as to be visible to the pilot of a landing aeroplane in the direction of approach to the runway.
  - (2) Simple touchdown zone lights characteristics should be in accordance with the specifications in [CS ADR-DSN.U.940](#), Figure U-9.
  - (3) Simple touchdown zone lights chromaticity should be in accordance with the specifications in [CS ADR-DSN.U.930](#) and Figure U-1A or U-1B, as appropriate.



**Figure M-8(C). Simple touchdown zone lighting**

[Issue: ADR-DSN/3]  
[Issue: ADR-DSN/4]

## GM1 ADR-DSN.M.696 Simple touchdown zone lights

ED Decision 2016/027/R

- (a) Simple touchdown zone lights should be supplied with power on a separate circuit to other runway lighting so that they may be used when other lighting is switched off.

[Issue: ADR-DSN/3]

## CS ADR-DSN.M.700 Rapid exit taxiway indicator lights (RETILs)

ED Decision 2017/021/R

- (a) Applicability:
- (1) The inclusion of specifications for RETILs is not intended to imply that RETILs have to be provided at an aerodrome.
  - (2) Where installed, the purpose of RETILs is to provide pilots with distance-to-go information to the nearest rapid exit taxiway on the runway, to enhance situational awareness in low visibility conditions and enable pilots to apply braking action for more efficient roll-out and runway exit speeds.
- (b) Location:
- (1) RETILs should be located on the runway on the same side of the runway centre line as the associated rapid exit taxiway. The lights should be located 2 m apart and the light nearest to the runway centre line should be displaced 2 m from the runway centre line.
  - (2) Where more than one rapid exit taxiway exists on a runway, the set of RETILs for each exit should not overlap when displayed.
- (c) Characteristics:
- (1) RETILs are fixed lights and comprise a set of yellow unidirectional lights installed in the runway adjacent to the centre line. The lights are positioned in a 3-2-1 sequence at 100 m intervals prior to the point of tangency of the rapid exit taxiway centre line.
  - (2) RETILs should be supplied with power on a separate circuit to other runway lighting so that they may be used when other lighting is switched off.
  - (3) RETILs' characteristics should be in accordance with the specifications in [CS ADR-DSN.U.940](#), Figure U-10 or U-11, as appropriate.
  - (4) RETILs' chromaticity should be in accordance with the specifications in [CS ADR-DSN.U.930](#) and Figure U-1A or U-1B, as appropriate.

[Issue: ADR-DSN/4]

## GM1 ADR-DSN.M.700 Rapid exit taxiway indicator lights (RETILs)

ED Decision 2017/021/R

- (a) In low visibility conditions, rapid exit taxiway indicator lights provide useful situational awareness cues while allowing the pilot to concentrate on keeping the aircraft on the runway centre line.
- (b) Rapid exit taxiway indicator lights should be considered on a runway intended for use in runway visual range conditions less than a value of 350 m where the traffic density is heavy.
- (c) Rapid exit taxiway indicator lights should not be displayed in the event of any lamp failure or other failure that prevents the display of the light pattern depicted in Figure GM-M-3.

- (d) Following a landing, runway occupancy time has a significant effect on the achievable runway capacity. Rapid exit taxiway indicator lights allow pilots to maintain a good roll-out speed until it is necessary to decelerate to an appropriate speed for the turn into a rapid exit turn-off. A roll-out speed of 60 kt until the first RETIL (three-light barrette) is reached is seen as the optimum.

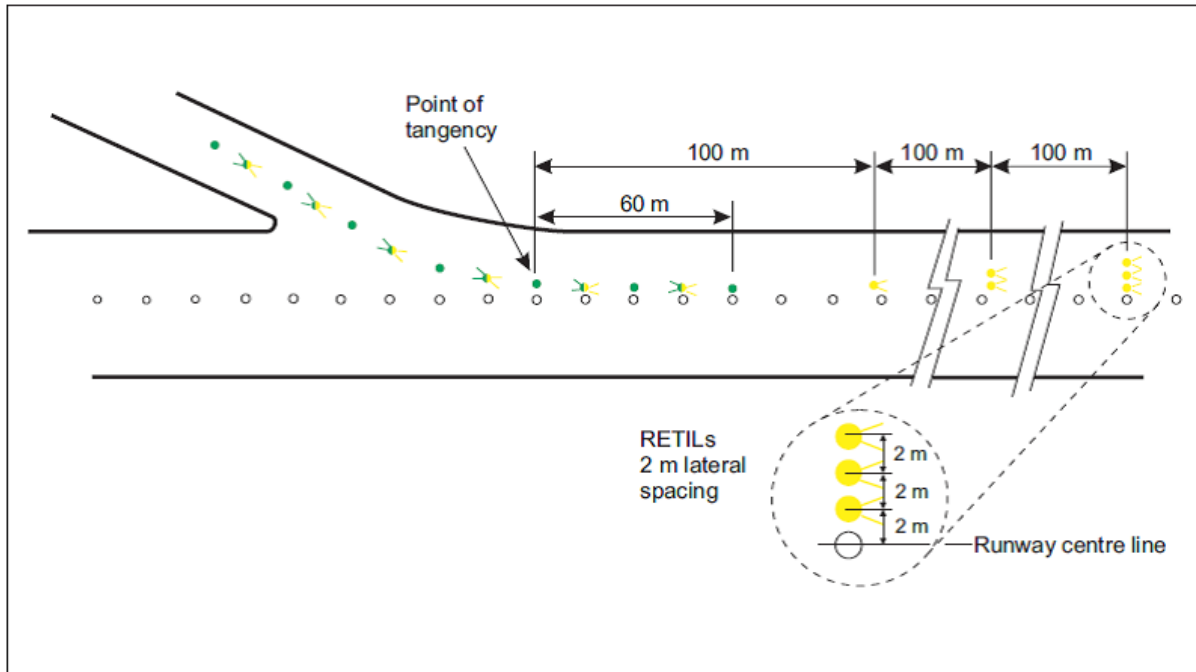


Figure GM-M-3. Rapid exit taxiway indicator lights (RETILs)

[Issue: ADR-DSN/3]

[Issue: ADR-DSN/4]

## CS ADR-DSN.M.705 Stopway lights

ED Decision 2021/004/R

- (a) Applicability: Stopway lights should be provided for a stopway intended for use at night, or in runway visual range conditions less than a value of 800 m.
- (b) Location:
- (1) Stopway lights should be placed along the full length of the stopway and should be in two parallel rows that are equidistant from the centre line and coincident with the rows of the runway edge lights. The spacing between the lights should be in accordance with [CS ADR-DSN.M.675\(b\)\(4\)](#). Stopway lights placed along the edge of the stopway should consist of at least one pair of lights.
  - (2) At least four uni-directional stopway lights equally spaced across the width of the stopway should be provided across the end of a stopway on a line at right angles to the stopway axis as near to the end of the stopway as possible and, in any case, not more than 3 m outside the end.
- (c) Characteristics:
- (1) Stopway lights should be fixed unidirectional lights showing red in the direction of the runway.

- (2) Stopway lights chromaticity should be in accordance with the specifications in [CS ADR-DSN.U.930](#) and Figure U-1A or U-1B, as appropriate.

[Issue: ADR-DSN/3]

[Issue: ADR-DSN/4]

[Issue: ADR-DSN/5]

## GM1 ADR-DSN.M.705 Stopway lights

ED Decision 2014/013/R

intentionally left blank

## CS ADR-DSN.M.706 Runway status lights (RWSL)

ED Decision 2017/021/R

- (a) Applicability:
- (1) The inclusion of detailed specification for RWSL is not intended to imply that RWSL have to be provided at an aerodrome.
  - (2) RWSL is a type of autonomous runway incursion warning system (see [CS ADR-DSN.T.921](#)), consisting of two basic visual components: runway entrance lights (RELs) and take-off hold lights (THLs). The two components can be installed individually, but are designed to complement each other.
- (b) Location:
- (1) Where provided, RELs should be offset 0.6 m from the taxiway centre line on the opposite side to the taxiway centre line lights and begin 0.6 m before the runway-holding position extending to the edge of the runway. An additional single light should be placed on the runway 0.6 m from the runway centre line and aligned with the last two taxiway RELs.
  - (2) RELs should consist of at least five light units and should be spaced at a minimum of 3.8 m and a maximum of 15.2 m longitudinally, depending upon the taxiway length involved, except for a single light installed near the runway centre line.
  - (3) Where provided, THLs should be offset 1.8 m on each side of the runway centre line lights and extend, in pairs, starting at a point 115 m from the beginning of the runway and, thereafter, every 30 m for at least 450 m.
- (c) Characteristics:
- (1) Where provided, RELs should consist of a single line of fixed in pavement lights showing red in the direction of aircraft approaching the runway.
  - (2) RELs should illuminate as an array at each taxiway/runway intersection where they are installed less than two seconds after the system determines that a warning is needed.
  - (3) RELs intensity and beam spread should be in accordance with the specifications of Chapter U, Figures U-16 and U-18.
  - (4) Where provided, THLs should consist of two rows of fixed in pavement lights showing red facing the aircraft taking off.
  - (5) THLs should illuminate as an array on the runway less than two seconds after the system determines that a warning is needed.

- (6) THLs intensity and beam spread should be in accordance with the specifications of Chapter U, Figure U-29.
- (7) RELs and THLs should be automated to the extent that the only control over each system will be to disable one or both systems.

[Issue: ADR-DSN/4]

## GM1 ADR-DSN.M.706 Runway status lights (RWSLs)

ED Decision 2017/021/R

- (a) Where two or more runway-holding positions are provided, the runway-holding position referred is that closest to the runway.
- (b) Additional take-off hold lights (THLs) may be similarly provided at the starting point of the take-off roll.
- (c) Consideration for reduced beam width may be required for some runway entrance lights (RELs) lights at acute-angled runway/taxiway intersections to ensure the RELs are not visible to aircraft on the runway.

[Issue: ADR-DSN/4]

## CS ADR-DSN.M.710 Taxiway centre line lights

ED Decision 2017/021/R

- (a) The safety objective of taxiway centre line lights is to provide guidance for the safe taxi of aircraft on a taxiway in reduced visibility conditions and at night.
- (b) Applicability:
  - (1) Taxiway centre line lights should be provided on an exit taxiway, taxiway, de-icing/anti-icing facility, and apron intended for use in runway visual range conditions less than a value of 350 m in such a manner as to provide continuous guidance between the runway centre line and aircraft stands, except that these lights need not be provided where the traffic density is light and taxiway edge lights, and centre line marking provide adequate guidance.
  - (2) Taxiway centre line lights should be provided on a taxiway intended for use at night in runway visual range conditions of 350 m or greater, and particularly on complex taxiway intersections and exit taxiways, except that these lights need not be provided where taxiway edge lights, and centre line marking provide adequate guidance.
  - (3) Taxiway centre line lights should be provided on an exit taxiway, taxiway, de-icing/anti-icing facility, and apron in all visibility conditions where specified as components of an advanced surface movement guidance and control system in such a manner as to provide continuous guidance between the runway centre line and aircraft stands.
  - (4) Taxiway centre line lights should be provided on a runway forming part of a standard taxi-route and intended for taxiing in runway visual range conditions less than a value of 350 m, except that these lights need not be provided where the traffic density is light and taxiway edge lights, and centre line marking provide adequate guidance.
  - (5) Taxiway centre line lights should be provided in all visibility conditions on a runway forming part of a standard taxi-route where specified as components of an advanced surface movement guidance and control system.



- (6) Where a runway forming part of a standard taxi route is provided with runway lighting and taxiway lighting, the lighting systems should be interlocked to preclude the possibility of simultaneous operation of both forms of lighting.
- (c) Characteristics:
- (1) Except as provided for in paragraph (c)(3) below, taxiway centre line lights on a taxiway other than an exit taxiway and on a runway forming part of a standard taxi-route should be fixed lights showing green with beam dimensions such that the light is visible only from aeroplanes on, or in the vicinity of the taxiway.
  - (2) Taxiway centre line lights on an exit taxiway should be fixed lights. Alternate taxiway centre line lights should show green and yellow from their beginning near the runway centre line to the perimeter of the ILS/MLS critical/sensitive area, or the lower edge of the inner transitional surface, whichever is farthest from the runway; and thereafter all lights should show green, as shown in Figure M-10. The first light in the exit centre line should always show green and the light nearest to the perimeter should always show yellow.
  - (3) Where necessary to denote the proximity to a runway, taxiway centre line lights should be fixed lights showing alternating green and yellow from the perimeter of the ILS/MLS critical/sensitive area or the lower edge of the inner transitional surface, whichever is farthest from the runway, to the runway and continue alternating green and yellow until:
    - (i) their end point near the runway centre line; or
    - (ii) in the case of the taxiway centre line lights crossing the runway, to the opposite perimeter of the ILS/MLS critical/sensitive area or the lower edge of the inner transitional surface, whichever is farthest from the runway.
  - (4) Taxiway centre line lights should be in accordance with the specifications in [CS ADR-DSN.U.940](#), Figure U-16, U-17, or U-18, as appropriate, for taxiways intended for use in runway visual range conditions of less than a value of 350 m; Figure U-19 or Figure U-20, as appropriate, for other taxiways.
  - (5) Where higher intensities are required, from an operational point of view, taxiway centre line lights on rapid exit taxiways intended for use in runway visual range conditions less than a value of 350 m should be in accordance with the specifications in [CS ADR-DSN.U.940](#), Figure U-16. The number of levels of brilliancy settings for these lights should be the same as that for the runway centre line lights.
  - (6) Where taxiway centre line lights are specified as components of an advanced surface movement guidance and control system and where, from an operational point of view, higher intensities are required to maintain ground movements at a certain speed in very low visibilities or in bright daytime conditions, taxiway centre line lights should be in accordance with the specifications in [CS ADR-DSN.U.940](#), Figure U-21, U-22, or U-23, as appropriate.
  - (7) High intensity centre line lights should only be used in case of an absolute necessity and following a specific study.
  - (8) Taxiway centre line lights chromaticity should be in accordance with the specifications in [CS ADR-DSN.U.930](#) and Figure U-1A or U-1B, as appropriate.

- (d) Location and positioning:
- (1) Taxiway centre line lights should normally be located on the taxiway centre line marking, except that they may be offset by not more than 30 cm where it is not practicable to locate them on the marking, as shown in Figure M-9.
  - (2) Taxiway centre line lights on taxiways, runways, rapid exit taxiways or on other exit taxiways should be positioned in accordance with [CS ADR-DSN.M.715](#).

[Issue: ADR-DSN/3]

[Issue: ADR-DSN/4]

## GM1 ADR-DSN.M.710 Taxiway centre line lights

ED Decision 2016/027/R

- (a) In the case where taxiway centre line lights are provided and where there may be a need to delineate the edges of a taxiway, e.g. on a rapid exit taxiway, narrow taxiway, or in snow conditions, this may be done with taxiway edge lights or markers. Care is necessary to limit the light distribution of green lights on or near a runway so as to avoid possible confusion with threshold lights.
- (b) Care should be taken to limit the light distribution of green lights on or near a runway so as to avoid possible confusion with threshold lights.
- (c) The provisions of [CS ADR-DSN.M.710\(c\)\(3\)](#) can form part of effective runway incursion prevention measures.

[Issue: ADR-DSN/3]

## CS ADR-DSN.M.715 Taxiway centre line lights on taxiways, runways, rapid exit taxiways, or on other exit taxiways

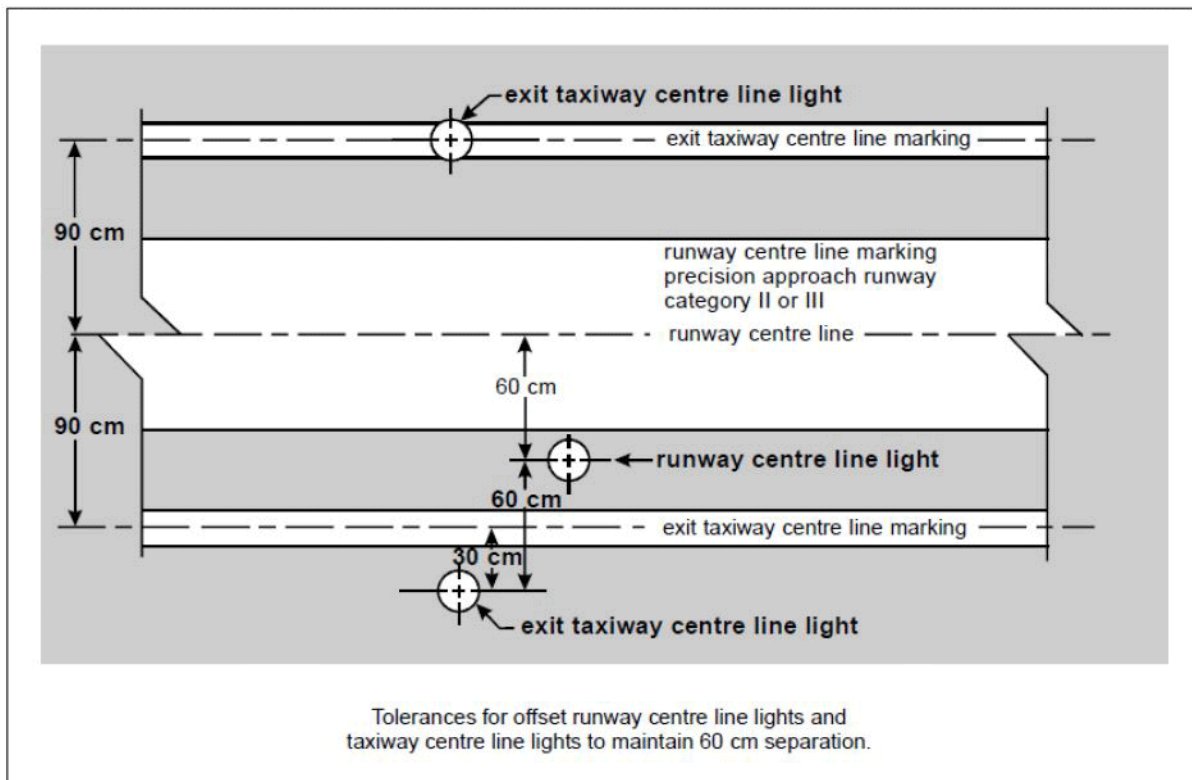
ED Decision 2016/027/R

- (a) The safety objective of taxiway centre line lights is to provide guidance for the safe taxi of aircraft on a taxiway de-icing/anti-icing facility, and apron in reduced visibility conditions and at night
- (b) Taxiway centre line lights on taxiways:
  - (1) Taxiway centre line lights on a straight section of a taxiway should be spaced at longitudinal intervals of not more than 30 m, except that:
    - (i) intervals less than 30 m should be provided on short straight sections; and
    - (ii) on a taxiway intended for use in RVR conditions of less than a value of 350 m, the longitudinal spacing should not exceed 15 m.
  - (2) Taxiway centre line lights on a taxiway curve should continue from the straight portion of the taxiway at a constant distance from the outside edge of the taxiway curve. The lights should be spaced at intervals such that a clear indication of the curve is provided.
  - (3) On a taxiway curve the spacing of taxiway centre line lights should be as specified in the Table M-3.

RVR	Radius of taxiway curve	Taxiway centre line lights spacing on taxiway curves
< 350 m	< 400 m	Not greater than 7.5 m. This spacing should extend for 60 m before and after the curve.
	≥ 400 m	Not greater than 15 m
≥ 350 m	< 400 m	Not greater than 7.5 m
	401 m to 899 m	Not greater than 15 m
	> 900 m	Not greater than 30 m

**Table M-3. Taxiway centre line lights spacing on taxiway curves**

- (c) Taxiway centre line lights on rapid exit taxiways:
- (1) Taxiway centre line lights on a rapid exit taxiway should commence at a point at least 60 m before the beginning of the taxiway centre line curve, and continue beyond the end of the curve to a point on the centre line of the taxiway where an aeroplane can be expected to reach normal taxiing speed, as shown in Figure M-10. The lights on that portion parallel to the runway centre line should always be at least 60 cm from any row of runway centre line lights, as shown in Figure M-9.
  - (2) The lights should be spaced at longitudinal intervals of not more than 15 m. Where runway centre line lights are not provided, a greater interval not exceeding 30 m may be used.
- (d) Taxiway centre line lights on other exit taxiways:
- (1) Taxiway centre line lights on exit taxiways other than rapid exit taxiways should commence at the point where the taxiway centre line marking begins to curve from the runway centre line, and follow the curved taxiway centre line marking at least to the point where the marking leaves the runway. The first light should be at least 60 cm from any row of runway centre line lights, as shown in Figure M-9.
  - (2) The lights should be spaced at longitudinal intervals of not more than 7.5 m.
- (e) Taxiway centre line lights on runways: Taxiway centre line lights on a runway forming part of a standard taxi-route, and intended for taxiing in runway visual range conditions less than a value of 350 m should be spaced at longitudinal intervals not exceeding 15 m.

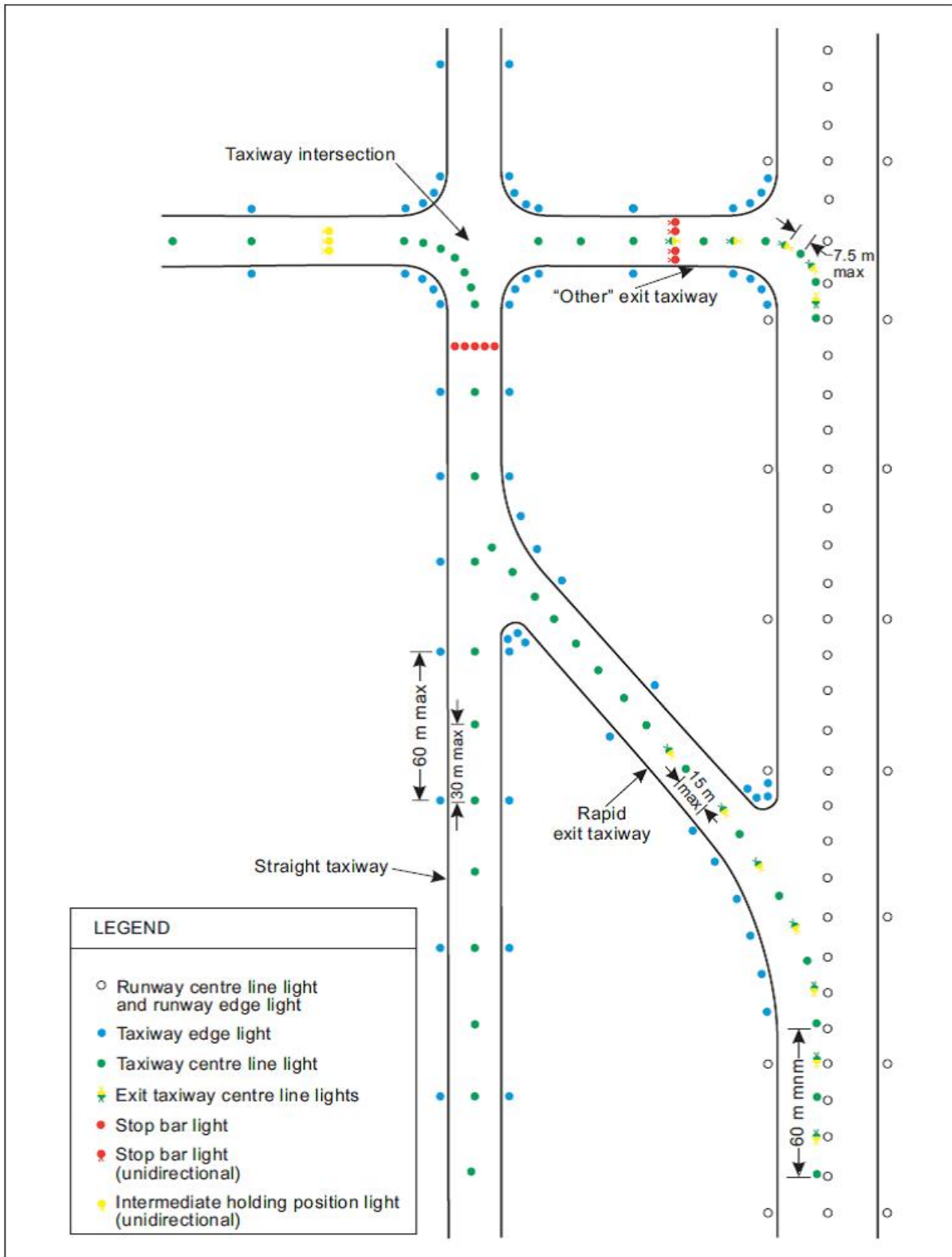


**Figure M-9. Offset runway and taxiway centre line lights**

- (f) Positioning of taxiway centre line lights on taxiway:

The spacing on a particular section of taxiway centre line lighting (straight or curved section) should be such that a clear indication of the taxiway centre line is provided, particularly on a curved section.

- (g) Taxiway centre line lights on straight sections of taxiways: Larger intervals not exceeding 60 m may be used where, because of the prevailing meteorological conditions, adequate guidance is provided by such spacing.



**Figure M-10. Taxiway lighting**

[Issue: ADR-DSN/3]

## GM1 ADR-DSN.M.715 Taxiway centre line lights on taxiways, runways, rapid exit taxiways, or on other exit taxiways

ED Decision 2014/013/R

intentionally left blank

## CS ADR-DSN.M.720 Taxiway edge lights

ED Decision 2017/021/R

(a) Applicability:

- (1) Taxiway edge lights should be provided at the edges of a runway turn pad, holding bay, de-icing/anti-icing facility, apron, etc. intended for use at night, and on a taxiway not provided with taxiway centre line lights and intended for use at night, except that taxiway edge lights need not be provided where, considering the nature of the operations, adequate guidance can be achieved by surface illumination or other means.
- (2) Taxiway edge lights should be provided on a runway forming part of a standard taxi-route and intended for taxiing at night where the runway is not provided with taxiway centre line lights.

(b) Location and positioning:

- (1) Taxiway edge lights on a straight section of a taxiway and on a runway forming part of a standard taxi-route should be spaced at uniform longitudinal intervals of not more than 60 m. The lights on a curve should be spaced at intervals less than 60 m so that a clear indication of the curve is provided.
- (2) Taxiway edge lights on a holding bay, de-icing/anti-icing facility, apron, etc. should be spaced at uniform longitudinal intervals of not more than 60 m.
- (3) Taxiway edge lights on a runway turn pad should be spaced at uniform longitudinal intervals of not more than 30 m.
- (4) The lights should be located as near as practicable to the edges of the taxiway, runway turn pad, holding bay, de-icing/anti-icing facility, apron or runway, etc., or outside the edges at a distance of not more than 3 m.

(c) Characteristics:

- (1) Taxiway edge lights should be fixed lights showing blue.
- (2) The lights should show up to at least 75° above the horizontal and at all angles in azimuth necessary to provide guidance to a pilot taxiing in either direction. At an intersection, exit, or curve the lights should be shielded as far as practicable so that they cannot be seen in angles of azimuth in which they may be confused with other lights.
- (3) The intensity of taxiway edge lights should be at least 2 cd from 0° to 6° vertical, and 0.2 cd at any vertical angles between 6° and 75°.
- (4) Taxiway edge lights chromaticity should be in accordance with the specifications in [CS ADR-DSN.U.930](#) and Figure U-1A or U-1B, as appropriate.

[Issue: ADR-DSN/3]

[Issue: ADR-DSN/4]

## GM1 ADR-DSN.M.720 Taxiway edge lights

ED Decision 2014/013/R

intentionally left blank

## CS ADR-DSN.M.725 Runway turn pad lights

ED Decision 2017/021/R

- (a) The safety objective of runway turn pad lights is to provide additional guidance on a runway turn pad to enable an aeroplane to complete a safe 180-degree turn, and align with the runway centre line.
- (b) Applicability:
  - (1) Runway turn pad lights should be provided for continuous guidance on a runway turn pad intended for use in runway visual range conditions less than a value of 350 m to enable an aeroplane to complete a 180-degree turn, and align with the runway centre line.
  - (2) Runway turn pad lights should be provided on a runway turn pad intended for use at night, except that these lights need not be provided where taxiway edge lights and runway turn pad marking provide adequate guidance.
- (c) Location:
  - (1) Runway turn pad lights should normally be located on the runway turn pad marking, except that they should be offset by not more than 30 cm where it is not practicable to locate them on the marking.
  - (2) Runway turn pad lights on a straight section of the runway turn pad marking should be spaced at longitudinal intervals of not more than 15 m.
  - (3) Runway turn pad lights on a curved section of the runway turn pad marking should not exceed a spacing of 7.5 m.
- (d) Characteristics:
  - (1) Runway turn pad lights should be unidirectional fixed lights showing green with beam dimensions such that the light is visible only from aeroplanes on or approaching the runway turn pad.
  - (2) Runway turn pad lights should be in accordance with the specifications in [CS ADR-DSN.U.940](#), Figure U-17 or Figure U-18, as appropriate.
  - (3) Runway turn pad lights chromaticity should be in accordance with the specifications in [CS ADR-DSN.U.930](#) and Figure U-1A or U-1B, as appropriate.

[Issue: ADR-DSN/3]

[Issue: ADR-DSN/4]

## GM1 ADR-DSN.M.725 Runway turn pad lights

ED Decision 2014/013/R

intentionally left blank

## CS ADR-DSN.M.730 Stop bars

ED Decision 2017/021/R

- (a) Applicability:
- (1) A stop bar should be provided at every runway-holding position serving a runway when it is intended that the runway should be used in runway visual range conditions less than a value of 550 m, except where:
    - (i) appropriate aids and procedures are available to assist in preventing inadvertent incursions of traffic onto the runway; or
    - (ii) operational procedures exist to limit, in runway visual range conditions less than a value of 550 m, the number of:
      - (A) aircraft on the manoeuvring area to one at a time; and
      - (B) vehicles on the manoeuvring area to the essential minimum.
  - (2) Where there is more than one stop bar associated with a taxiway/runway intersection, only one should be illuminated at any given time.
  - (3) A stop bar should be provided at an intermediate holding position when it is desired to supplement markings with lights, and to provide traffic control by visual means.
- (b) Location: Stop bars should be located across the taxiway at the point where it is desired that traffic stop.
- (c) Characteristics:
- (1) Stop bars should consist of lights spaced at uniform intervals of not more than 3 m across the taxiway, showing red in the intended direction(s) of approach to the intersection or runway-holding position.
  - (2) Stop bars installed at a runway-holding position should be unidirectional, and should show red in the direction of approach to the runway.
  - (3) The intensity in red light and beam spreads of stop bar lights should be in accordance with the specifications in [CS ADR-DSN.U.940](#), Figures U-16 to U-20, as appropriate.
  - (4) Where stop bars are specified as components of an advanced surface movement guidance and control system, and where, from an operational point of view, higher intensities are required to maintain ground movements at a certain speed in very low visibilities or in bright daytime conditions, the intensity in red light and beam spreads of stop bar lights should be in accordance with the specifications in [CS ADR-DSN.U.940](#), Figures U-21, U-22 or U-23, as appropriate.
  - (5) Where a wide beam fixture is required, the intensity in red light and beam spreads of stop bar lights should be in accordance with the specifications in [CS ADR-DSN.U.940](#), Figure U-21 or Figure U-23, as appropriate.
  - (6) The lighting circuit should be designed so that:
    - (i) stop bars located across entrance taxiways are selectively switchable;
    - (ii) stop bars located across taxiways intended to be used only as exit taxiways are switchable selectively or in groups;
    - (iii) when a stop bar is illuminated, any taxiway centre line lights installed beyond the stop bar should be extinguished for a distance of at least 90 m; and



- (iv) stop bars are interlocked with the taxiway centre line lights so that when the centre line lights beyond the stop bar are illuminated, the stop bar is extinguished and vice versa.
- (7) Stop bar lights chromaticity should be in accordance with the specifications in [CS ADR-DSN.U.930](#) and Figure U-1A or U-1B, as appropriate.

[Issue: ADR-DSN/3]

[Issue: ADR-DSN/4]

## GM1 ADR-DSN.M.730 Stop bars

ED Decision 2016/027/R

- (a) A stop bar is intended to be controlled either manually or automatically by air traffic services.
- (b) Runway incursions may take place in all visibility or weather conditions. The provision of stop bars at runway-holding positions and their use at night and in visibility conditions greater than 550 m runway visual range can form part of effective runway incursion prevention measures.
- (c) A pair of elevated lights should be added to each end of the stop bar where the in-pavement stop bar lights might be obscured from a pilot's view, for example by snow or rain, or where a pilot may be required to stop the aircraft in a position so close to the lights that they are blocked from view by the structure of the aircraft.
- (d) Where necessary, to enhance conspicuity of an existing stop bar, extra lights are installed uniformly.
- (e) Where the additional lights specified in (c) above are provided, these lights should be located not less than 3 m from the taxiway edge.
- (f) Where the additional lights specified in (c) above are provided, these lights should have the same characteristics as the lights in the stop bar but should be visible to approaching aircraft up to the stop bar position.
- (g) High-intensity stop bars should only be used in case of an absolute necessity and following a specific study.
- (h) Care is required in the design of the electrical system to ensure that all of the lights of a stop bar will not fail at the same time. Guidance on this issue is given in ICAO Doc 9157, Aerodrome Design Manual, Part 5, Electrical Systems.

[Issue: ADR-DSN/3]

## CS ADR-DSN.M.735 Intermediate holding position lights

ED Decision 2017/021/R

- (a) Applicability:
  - (1) Except where a stop bar has been installed, intermediate holding position lights should be provided at an intermediate holding position intended for use in runway visual range conditions less than a value of 350 m.
  - (2) Intermediate holding position lights should be provided at an intermediate holding position where there is no need for stop-and-go signals as provided by a stop bar.
- (b) Location: Intermediate holding position lights should be located along the intermediate holding position marking at a distance of 0.3 m prior to the marking.

- (c) Characteristics of intermediate holding position lights:
- (1) Intermediate holding position lights should consist of three fixed unidirectional lights showing yellow in the direction of approach to the intermediate holding position with a light distribution similar to taxiway centre line lights if provided.
  - (2) The lights should be disposed symmetrically about and at right angle to the taxiway centre line, with individual lights spaced 1.5 m apart.
  - (3) Intermediate holding position lights chromaticity should be in accordance with the specifications in [CS ADR-DSN.U.930](#) and in Figure U-1A or U-1B, as appropriate.

[Issue: ADR-DSN/3]

[Issue: ADR-DSN/4]

## GM1 ADR-DSN.M.735 Intermediate holding position lights

ED Decision 2014/013/R

intentionally left blank

## CS ADR-DSN.M.740 De-icing/anti-icing facility exit lights

ED Decision 2017/021/R

- (a) Applicability: The purpose of the de-icing/anti-icing facility exit lights is to indicate the exit boundary of a remote de-icing/anti-icing facility adjoining a taxiway.
- (b) Location: Where provided, de-icing/anti-icing facility exit lights should be located 0.3 m inward of the intermediate holding position marking displayed at the exit boundary of a remote de-icing/ anti-icing facility.
- (c) Characteristics: Where provided, de-icing/anti-icing facility exit lights should consist of in-pavement fixed unidirectional lights spaced at intervals of 6 m showing yellow in the direction of the approach to the exit boundary with a light distribution similar to taxiway centre line lights (see Figure M-11).
- (d) De-icing/anti-icing facility exit lights chromaticity should be in accordance with the specifications in [CS ADR-DSN.U.930](#) and Figure U-1A or U-1B, as appropriate.

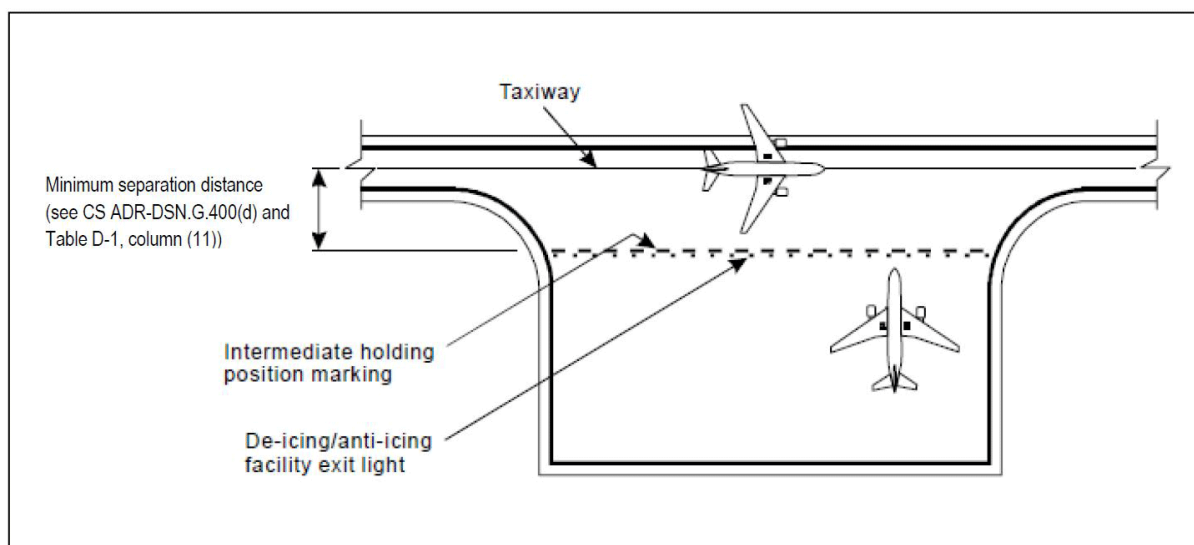


Figure M-11. Example of remote de-icing/anti-icing facility

[Issue: ADR-DSN/3]

[Issue: ADR-DSN/4]

## GM1 ADR-DSN.M.740 De-icing/anti-icing facility exit lights

ED Decision 2014/013/R

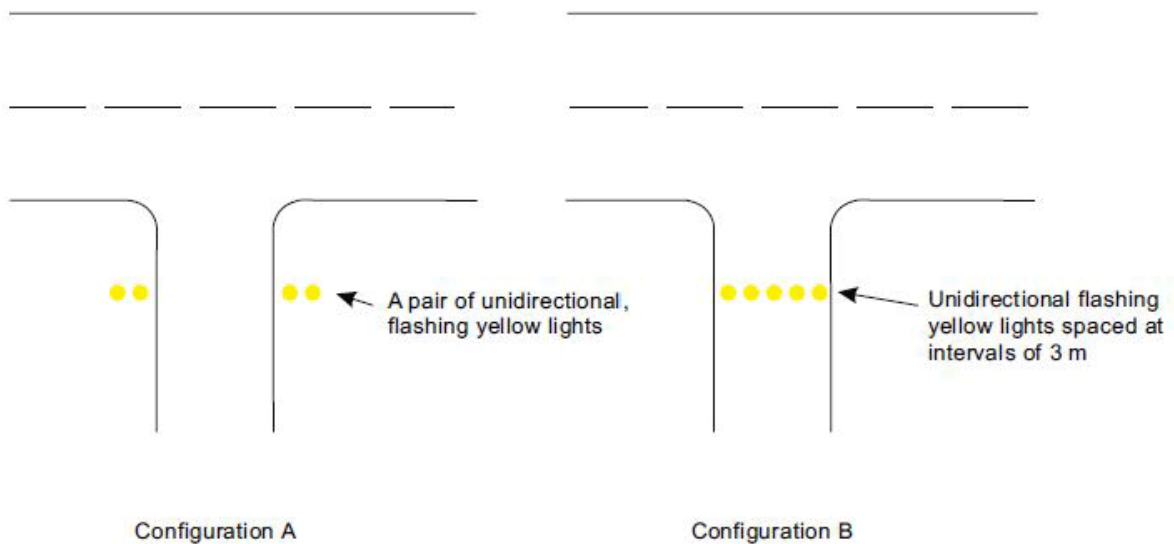
intentionally left blank

## CS ADR-DSN.M.745 Runway guard lights

ED Decision 2017/021/R

- (a) The purpose of runway guard lights is to warn pilots and drivers of vehicles when they are operating on taxiways, that they are about to enter an active runway. There are two standard configurations of runway guard lights as illustrated in Figure M-12.
- (b) Applicability:
- (1) Runway guard lights, Configuration A, should be provided at each taxiway/runway intersection associated with a runway intended for use in:
    - (i) runway visual range conditions less than a value of 550 m where a stop bar is not installed; and
    - (ii) runway visual range conditions of values between 550 m and 1 200 m where the traffic density is heavy.
  - (2) As part of runway incursion prevention measures, runway guard lights, Configuration A or B, should be provided at each taxiway/runway intersection where runway incursion hot spots have been identified, and used under all weather conditions during day and night.
  - (3) Configuration B runway guard lights should not be collocated with a stop bar.
- (c) Location:
- (1) Runway guard lights, Configuration A should be located at each side of the taxiway and at the same distance as the runway-holding position marking.
  - (2) Runway guard lights, Configuration B, should be located across the taxiway and at the same distance as the runway-holding position marking.
- (d) Characteristics:
- (1) Runway guard lights, Configuration A, should consist of two pairs of yellow lights.
  - (2) Runway guard lights, Configuration B, should consist of yellow lights spaced at intervals of 3 m across the taxiway.
  - (3) The light beam should be unidirectional and aligned so as to be visible to the pilot of an aeroplane taxiing to the holding position.
  - (4) The intensity in yellow light and beam spreads of lights of Configuration A should be in accordance with the specifications in [CS ADR-DSN.U.940](#), Figure U-27.
  - (5) Where runway guard lights are intended for use during the day, the intensity in yellow light and beam spreads of lights of Configuration A should be in accordance with the specifications in [CS ADR-DSN.U.940](#), Figure U-28.

- (6) Where runway guard lights are specified as components of an advanced surface movement guidance and control system where higher light intensities are required, the intensity in yellow light and beam spreads of lights of Configuration A should be in accordance with the specifications in [CS ADR-DSN.U.940](#), Figure U-28.
- (7) The intensity in yellow light and beam spreads of lights of Configuration B should be in accordance with the specifications in [CS ADR-DSN.U.940](#), Figure U-28.
- (8) Where runway guard lights are intended for use during the day, the intensity in yellow light and beam spreads of lights of Configuration B should be in accordance with the specifications in [CS ADR-DSN.U.940](#), Figure U-24.
- (9) Where runway guard lights are specified as components of an advanced surface movement guidance and control system where higher light intensities are required, the intensity in yellow light and beam spreads of lights of Configuration B should be in accordance with the specifications in [CS ADR-DSN.U.940](#), Figure U-24.
- (10) The lights in each unit of Configuration A should be illuminated alternately.
- (11) For Configuration B, adjacent lights should be alternately illuminated and alternative lights should be illuminated in unison.
- (12) The lights should be illuminated between 30 and 60 cycles per minute and the light suppression and illumination periods should be equal and opposite in each light.
- (13) Runway guard lights chromaticity should be in accordance with the specifications in [CS ADR-DSN.U.930](#) and Figure U-1A or U-1B, as appropriate.



**Figure M-12. Runway guard lights**

[Issue: ADR-DSN/3]

[Issue: ADR-DSN/4]

## GM1 ADR-DSN.M.745 Runway guard lights

ED Decision 2016/027/R

- (a) Some other device or design, e.g. specially designed optics, may be used in lieu of the visor.
- (b) Higher light intensities may be required to maintain ground movement at a certain speed in low visibilities
- (c) The optimum flash rate is dependent on the rise and fall times of the lamps used. Runway guard lights, Configuration A, installed on 6.6 ampere series circuits have been found to look best when operated at 45 to 50 flashes per minute per lamp. Runway guard lights, Configuration B, installed on 6.6 ampere series circuits have been found to look best when operated at 30 to 32 flashes per minute per lamp.
- (d) Where there is a need to enhance the contrast between the on- and off-state of runway guard lights, Configuration A, intended for use during the day, a visor of sufficient size to prevent sunlight from entering the lens without interfering with the function of the fixture should be located above each lamp.
- (e) Active runway is to consider any runway or runways currently being used for take-off or landing. When multiple runways are used, they are all considered active runways.

[Issue: ADR-DSN/3]

## CS ADR-DSN.M.750 Apron floodlighting

ED Decision 2016/027/R

- (a) The purpose of apron floodlighting is to facilitate safe operations on an apron, on a de-icing/anti-icing facility, and on a designated isolated aircraft parking position intended to be used at night.
- (b) Applicability: Apron floodlighting should be provided on an apron, as necessary on a de-icing/anti-icing facility, and on a designated isolated aircraft parking position intended to be used at night. Aprons primarily used for recreational flying need not be illuminated.
- (c) Location: Apron floodlights should be located so as to provide adequate illumination on all apron service areas, with a minimum of glare to pilots of aircraft in flight and on the ground, aerodrome and apron controllers, and personnel on the apron. The arrangement and aiming of floodlights should be such that an aircraft stand receives light from two or more directions to minimise shadows.
- (d) Characteristics:
  - (1) The spectral distribution of apron floodlights should be such that the colours used for aircraft marking connected with routine servicing, and for surface and obstacle marking, can be correctly identified.
  - (2) The average illuminance should be at least the following:
    - (i) Aircraft stand:
      - (A) horizontal illuminance — 20 lux with a uniformity ratio (average to minimum) of not more than 4 to 1; and
      - (B) vertical illuminance — 20 lux at a height of 2 m above the apron in relevant directions.

- (ii) Other apron areas: horizontal illuminance — 50 % of the average illuminance on the aircraft stands with a uniformity ratio (average to minimum) of not more than 4 to 1.

[Issue: ADR-DSN/3]

## GM1 ADR-DSN.M.750 Apron floodlighting

*ED Decision 2017/021/R*

- (a) Where a de-icing/anti-icing facility is located in close proximity to the runway and permanent floodlighting could be confusing to pilots, other means of illumination of the facility may be required.
- (b) Additional guidance on apron floodlighting is given in ICAO Doc 9157, Aerodrome Design Manual, Part 4, Visual Aids.

[Issue: ADR-DSN/4]

## CS ADR-DSN.M.755 Visual docking guidance system

*ED Decision 2014/013/R*

- (a) Applicability: A visual docking guidance system should be provided when it is intended to indicate, by a visual aid, the precise positioning of an aircraft on an aircraft stand and other alternative means, such as marshallers, are not practicable.
- (b) Characteristics:
  - (1) The system should provide both azimuth and stopping guidance.
  - (2) The azimuth guidance unit and the stopping position indicator should be adequate for use in all weather, visibility, background lighting, and pavement conditions for which the system is intended both by day and night but should not dazzle the pilot.
  - (3) The azimuth guidance unit and the stopping position indicator should be of a design such that:
    - (i) a clear indication of malfunction of either or both is available to the pilot; and
    - (ii) they can be turned off.
  - (4) The accuracy of the system should be adequate for the type of loading bridge and fixed aircraft servicing installations with which it is to be used.
  - (5) The system should be usable by all types of aircraft for which the aircraft stand is intended, preferably without selective operation.
  - (6) If selective operation is required to prepare the system for use by a particular type of aircraft, then the system should provide an identification of the selected aircraft type to both the pilot and the system operator as a means of ensuring that the system has been set properly.
- (c) Location:
  - (1) The azimuth guidance unit and the stopping position indicator should be located in such a way that there is continuity of guidance between the aircraft stand markings, the aircraft stand manoeuvring guidance lights if present, and the visual docking guidance system.

- (2) The azimuth guidance unit should be located on or close to the extension of the stand centre line ahead of the aircraft so that its signals are visible from the cockpit of an aircraft throughout the docking manoeuvre, and aligned for use at least by the pilot occupying the left seat, although it is preferable for it to be aligned for use by the pilots occupying both the left and right seats.
- (3) The azimuth guidance unit and the stopping position indicator should be positioned as prescribed below.
  - (i) The azimuth guidance unit should provide unambiguous left/right guidance which enables the pilot to acquire and maintain the lead-in line without over-controlling.
  - (ii) When azimuth guidance is indicated by colour change, green should be used to identify the centre line and red for deviations from the centre line.
  - (iii) The stopping position indicator should be located in conjunction with, or sufficiently close to, the azimuth guidance unit so that a pilot can observe both the azimuth and stop signals without turning the head.
  - (iv) The stopping position indicator should be usable at least by the pilot occupying the left seat, although it is preferable for it to be usable by the pilots occupying both the left and right seats.
  - (v) The stopping position information provided by the indicator for a particular aircraft type should account for the anticipated range of variations in pilot eye height and/or viewing angle.
  - (vi) The stopping position indicator should show the stopping position for the aircraft for which guidance is being provided and should provide closing rate information to enable the pilot to gradually decelerate the aircraft to a full stop at the intended stopping position.
  - (vii) The stopping position indicator should provide closing rate information over a distance of at least 10 m.
  - (viii) When stopping guidance is indicated by colour change, green should be used to show that the aircraft can proceed and red to show that the stop point has been reached, except that for a short distance prior to the stop point a third colour may be used to warn that the stopping point is close.

## **GM1 ADR-DSN.M.755 Visual docking guidance system**

*ED Decision 2014/013/R*

- (a) The factors to be considered in evaluating the need for a visual docking guidance system are in particular: the number and type(s) of aircraft using the aircraft stand, weather conditions, space available on the apron, and the precision required for manoeuvring into the parking position due to aircraft servicing installation, passenger loading bridges, etc.
- (b) Care is required in both the design and on-site installation of the system to ensure that reflection of sunlight, or other light in the vicinity, does not degrade the clarity and conspicuity of the visual cues provided by the system.

## **CS ADR-DSN.M.760 Advanced visual docking guidance system**

*ED Decision 2017/021/R*

(a) **Applicability:**

- (1) Advanced visual docking guidance system (A-VDGS) should be provided where it is operationally desirable to confirm the correct aircraft type for which guidance is being provided, and/or to indicate the stand centre line in use, where more than one is provided for.
- (2) The Advanced visual docking guidance system should be suitable for use by all types of aircraft for which the aircraft stand is intended.
- (3) The Advanced visual docking guidance system should only be used in conditions in which its operational performance is specified.
- (4) The docking guidance information provided by an advanced visual docking guidance system should not conflict with that provided by a conventional visual docking guidance system on an aircraft stand if both types are provided, and are in operational use. A method of indicating that the system is not in operational use or unserviceable should be provided.
- (5) **Location:** The Advanced visual docking guidance system should be located such that unobstructed and unambiguous guidance is provided to the person responsible for, and persons assisting, the docking of the aircraft throughout the docking manoeuvre.

(b) **Characteristics:**

- (1) The Advanced visual docking guidance system should provide, at minimum, the following guidance information at the appropriate stage of the docking manoeuvre:
  - (i) an emergency stop indication;
  - (ii) the aircraft type and model for which the guidance is provided;
  - (iii) an indication of the lateral displacement of the aircraft relative to the stand centre line;
  - (iv) the direction of azimuth correction needed to correct a displacement from the stand centre line;
  - (v) an indication of the distance to the stop position;
  - (vi) an indication when the aircraft has reached the correct stopping position; and
  - (vii) a warning indication if the aircraft goes beyond the appropriate stop position.
- (2) The Advanced visual docking guidance system should be capable of providing docking guidance information for all aircraft taxi speeds encountered during the docking manoeuvre.
- (3) The time taken from the determination of the lateral displacement to its display should not result in a deviation of the aircraft when operated in normal conditions, from the stand centre line greater than 1 m.
- (4) The information on displacement of the aircraft relative to the stand centre line and distance to the stopping position, when displayed, should be provided with the accuracy specified in Table M-4. Symbols and graphics used to depict guidance information should be intuitively representative of the type of information provided.



- (i) Information on the lateral displacement of the aircraft relative to the stand centre line should be provided at least 25 m prior to the stop position.
- (ii) Continuous closure distance and closure rate should be provided from at least 15 m prior to the stop position.
- (iii) Where provided, closure distance displayed in numerals should be provided in metre integers to the stop position and displayed to 1 decimal place at least 3 m prior to the stop position.
- (iv) Throughout the docking manoeuvre, an appropriate means should be provided on the Advanced visual docking guidance system to indicate the need to bring the aircraft to an immediate halt. In such an event which includes a failure of the system, no other information should be displayed.
- (v) Provision to initiate an immediate halt to the docking procedure should be made available to personnel responsible for the operational safety of the stand.
- (vi) The word 'STOP' in red characters should be displayed when an immediate cessation of the docking manoeuvre is required.

Guidance information	Maximum deviation at stop position (stop area)	Maximum deviation at 9 m from stop position	Maximum deviation at 15 m from stop position	Maximum deviation at 25 m from stop position
Azimuth	±250 mm	±340 mm	±400 mm	±500 mm
Distance	±500 mm	±1 000 mm	±1 300 mm	Not specified

**Table M-4. A-VDGS recommended displacement accuracy**

[Issue: ADR-DSN/3]

[Issue: ADR-DSN/4]

## GM1 ADR-DSN.M.760 Advanced visual docking guidance system

*ED Decision 2014/013/R*

- (a) Advanced visual docking guidance systems should include those systems that, in addition to basic and passive azimuth, and stop position information, provide pilots with active (usually sensor-based) guidance information, such as aircraft type indication, distance-to-go information, and closing speed. Docking guidance information is usually provided in a single display unit.
- (b) Advanced visual docking guidance systems should include those systems that, in addition to basic and passive azimuth, and stop position information, provide pilots with active (usually sensor-based) guidance information, such as aircraft type indication, distance-to-go information, and closing speed. Docking guidance information is usually provided in a single display unit.
- (c) The use of the Advanced visual docking guidance systems in conditions such as weather, visibility, and background lighting both by day and night would need to be specified.
- (d) Care is required in both the design and on-site installation of the system to ensure that glare, reflection of sunlight, or other light in the vicinity, does not degrade the clarity and conspicuity of the visual cues provided by the system.

- (e) The use of colour needs to be appropriate and should follow signal convention, i.e. red, yellow and green mean hazard, caution and normal/correct conditions respectively. The effects of colour contrasts also need to be considered.
- (f) The indication of the distance of the aircraft from the stop position may be colour-coded and presented at a rate and distance proportional to the actual closure rate, and distance of the aircraft approaching the stop point.

## CS ADR-DSN.M.765 Aircraft stand manoeuvring guidance lights

ED Decision 2014/013/R

- (a) **Applicability:** Aircraft stand manoeuvring guidance lights should be provided to facilitate the positioning of an aircraft on an aircraft stand on a paved apron, or on a de-icing/anti-icing facility intended for use in poor visibility conditions unless adequate guidance is provided by other means.
- (b) **Location:** Aircraft stand manoeuvring guidance lights should be collocated with the aircraft stand markings.
- (c) **Characteristics:**
  - (1) Aircraft stand manoeuvring guidance lights, other than those indicating a stop position, should be fixed yellow lights, visible throughout the segments within which they are intended to provide guidance.
  - (2) The lights used to delineate lead-in, turning, and lead-out lines should be spaced at intervals of not more than 7.5 m on curves and 15 m on straight sections.
  - (3) The lights indicating a stop position should be fixed, unidirectional lights showing red.
  - (4) The intensity of the lights should be adequate for the condition of visibility and ambient light in which the use of the aircraft stand is intended.
  - (5) The lighting circuit should be designed so that the lights may be switched on to indicate that an aircraft stand is to be used, and switched off to indicate that it is not to be used.

## GM1 ADR-DSN.M.765 Aircraft stand manoeuvring guidance lights

ED Decision 2014/013/R

intentionally left blank

## CS ADR-DSN.M.770 Road-holding position light

ED Decision 2016/027/R

- (a) **Applicability:** A road-holding position light should be provided at each road-holding position serving a runway when it is intended that the runway should be used in runway visual range conditions less than a value of 550 m.
- (b) **Location:** A road-holding position light should be located adjacent to the holding position marking 1.5 m ( $\pm 0.5$  m) from one edge of the road, i.e. left or right as appropriate to the local road traffic regulations.
- (c) **Characteristics:**
  - (1) The road-holding position light should comprise:
    - (i) a controllable red (stop)/green (go) traffic light; or

- (ii) a flashing-red light
- (2) Provisions for control of the lights in paragraph (1)(i) above should be installed in the positions for the air traffic services.
- (3) The road-holding position light beam should be unidirectional and aligned so as to be visible to the driver of a vehicle approaching the holding position.
- (4) The intensity of the light beam should be adequate for the conditions of visibility and ambient light in which the use of the holding position is intended but should not dazzle the driver.
- (5) The flash frequency of the flashing red light should be between 30 and 60 flashes per minute.

[Issue: ADR-DSN/3]

## GM1 ADR-DSN.M.770 Road-holding position light

ED Decision 2014/013/R

Where a road intersects a taxiway where operationally required, a suitable holding position light may be located adjacent to the roadway/taxiway intersection marking 1.5 m ( $\pm 0.5$  m) from one edge of the road, i.e. left or right as appropriate to the local road traffic regulations.

## CS ADR-DSN.M.771 No-entry bar

ED Decision 2017/021/R

- (a) **Applicability:** A no-entry bar should be provided across a taxiway which is intended to be used as an exit only taxiway. The purpose of a no-entry bar is to assist in preventing inadvertent access of traffic to that taxiway.
- (b) **Location:** A no-entry bar should be located across the taxiway at the end of an exit only taxiway where it is desired to prevent traffic from entering the taxiway in the wrong direction.
- (c) **Characteristics:**
  - (1) A no-entry bar should consist of unidirectional lights spaced at uniform intervals of no more than 3 m showing red in the intended direction(s) of approach to the runway.
  - (2) The lighting circuit should be so designed that:
    - (i) no-entry bars are switchable selectively or in groups;
    - (ii) when a no-entry bar is illuminated, any taxiway centre line lights installed beyond the no-entry bar, when viewed towards the runway, should be extinguished for a distance of at least 90 m; and
    - (iii) when a no-entry bar is illuminated, any stop bar installed between the no-entry bar and the runway should be extinguished.
  - (3) The intensity in red light and beam spreads of no-entry bar lights should be in accordance with the specifications in [CS ADR-DSN.U.940](#), Figures U-16 to U-20, as appropriate.
  - (4) No-entry bar lights chromaticity should be in accordance with the specifications in [CS ADR-DSN.U.930](#) and Figure U-1A or U-1B, as appropriate.

[Issue: ADR-DSN/3]

[Issue: ADR-DSN/4]

## GM1 ADR-DSN.M.771 No-entry bar

ED Decision 2016/027/R

- (a) A no-entry bar is intended to be controlled either manually or automatically by air traffic services.
- (b) Runway incursions may take place in all visibility or weather conditions. The provision of no-entry bars at taxiway/runway intersections and their use at night and in all visibility conditions can form part of effective runway incursion prevention measures.
- (c) Where necessary to enhance conspicuity, extra lights should be installed uniformly.
- (d) A pair of elevated lights should be added to each end of the no-entry bar where the in-pavement no-entry bar lights might be obscured from a pilot's view, for example, by snow or rain, or where a pilot may be required to stop the aircraft in a position so close to the lights that they are blocked from view by the structure of the aircraft.
- (e) Where no-entry bars are specified as components of an advanced surface movement guidance and control system and where, from an operational point of view, higher intensities are required to maintain ground movements at a certain speed in very low visibilities or in bright daytime conditions, the intensity in red light and beam spreads of no-entry bar lights should be in accordance with the specifications in [CS ADR-DSN.U.940](#), Figures U-21, U-22 or U-23, as appropriate.
- (f) High-intensity no-entry bars are typically used only in case of an absolute necessity and following a safety assessment.
- (g) Where a wide beam fixture is required, the intensity in red light and beam spreads of no-entry bar lights should be in accordance with the specifications in [CS ADR-DSN.U.940](#), Figures U-21 or U-23, as appropriate.
- (h) Care is required in the design of the electrical system to ensure that all of the lights of a no-entry bar will not fail at the same time. No-entry bar lights should be supplied with power on a separate circuit to other runway lighting so that they may be used when other lighting is switched off.

[Issue: ADR-DSN/3]

## CHAPTER N — VISUAL AIDS FOR NAVIGATION (SIGNS)

### CS ADR-DSN.N.775 General

ED Decision 2017/021/R

- (a) Signs should be either fixed message signs or variable message signs.
- (b) Applicability:
  - (1) Signs should be provided to convey a mandatory instruction, information on a specific location, or destination on a movement area or to provide other information necessary for the implementation of surface movement guidance and control system (SMGCS) at an aerodrome.
  - (2) A variable message sign should be provided where:
    - (i) the instruction or information displayed on the sign is relevant only during a certain period of time; and/or
    - (ii) there is a need for variable predetermined information to be displayed on the sign to meet the requirements of the implementation of surface movement guidance and control system (SMGCS) at an aerodrome.
- (c) Characteristics:
  - (1) Signs should be frangible. Those located near a runway or taxiway should be sufficiently low to preserve clearance for propellers and the engine pods of jet aircraft. The installed height of the sign should not exceed the dimension shown in the appropriate column of Table N-1.
  - (2) Signs should be rectangular, as shown in Figures N-4 and N-6 with the longer side horizontal.
  - (3) The only signs on the movement area utilising red should be mandatory instruction signs.
  - (4) The inscriptions on a sign should be in accordance with the provisions of Figures N-2A to N-2H and N-3.
  - (5) Signs should be illuminated when intended for use:
    - (i) in runway visual range conditions less than a value of 800 m; or
    - (ii) at night in association with instrument runways; or
    - (iii) at night in association with non-instrument runways where the code number is 3 or 4.
  - (6) Signs should be retroreflective and/or illuminated when intended for use at night in association with non-instrument runways where the code number is 1 or 2.
  - (7) Where variable pre-determined information is required, a variable sign should be provided.
    - (i) A variable message sign should show a blank face when not in use.
    - (ii) In case of failure, a variable message sign should not provide information that could lead to unsafe action from a pilot or a vehicle driver.
    - (iii) The time interval to change from one message to another on a variable message sign should be as short as practicable and should not exceed 5 seconds.

Runway code number	Sign height (mm)			Perpendicular distance from defined taxiway pavement edge to near side of sign	Perpendicular distance from defined runway pavement edge to near side of sign
	Legend	Face (min)	Installed (max)		
1 or 2	200	400	700	5–11 m	3–10 m
1 or 2	300	600	900	5–11 m	3–10 m
3 or 4	300	600	900	11–21 m	8–15 m
3 or 4	400	800	1 100	11–21 m	8–15 m

**Table N-1. Location distances for taxiing guidance signs including runway exit signs**

(8) Inscription heights should conform to the Table N-2.

Runway code number	Minimum character height		
	Mandatory instruction sign	Information sign	
		Runway exit and runway vacated signs	Other signs
1 or 2	300 mm	300 mm	200 mm
3 or 4	400 mm	400 mm	300 mm

**Table N-2. Minimum character height**

(9) Where a taxiway location sign is installed in conjunction with a runway designation sign (see [CS ADR-DSN.N.785\(b\)\(9\)](#)), the character size should be that specified for mandatory instruction signs.

(i) Arrow dimensions should be as follows:

Legend height	Stroke
200 mm	32 mm
300 mm	48 mm
400 mm	64 mm

(ii) Stroke width for single letter should be as follows:

Legend height	Stroke
200 mm	32 mm
300 mm	48 mm
400 mm	64 mm

(10) Sign luminance should be as follows:

(i) Where operations are conducted in runway visual range conditions less than a value of 800 m, average sign luminance should be at least:

Red	30 cd/m <sup>2</sup>
Yellow	150 cd/m <sup>2</sup>
White	300 cd/m <sup>2</sup>

(ii) Where operations are conducted in accordance with [CS ADR-DSN.N.775\(c\)\(5\)\(ii\) and \(c\)\(6\)](#), average sign luminance should be at least:

Red	10 cd/m <sup>2</sup>
Yellow	50 cd/m <sup>2</sup>
White	100 cd/m <sup>2</sup>

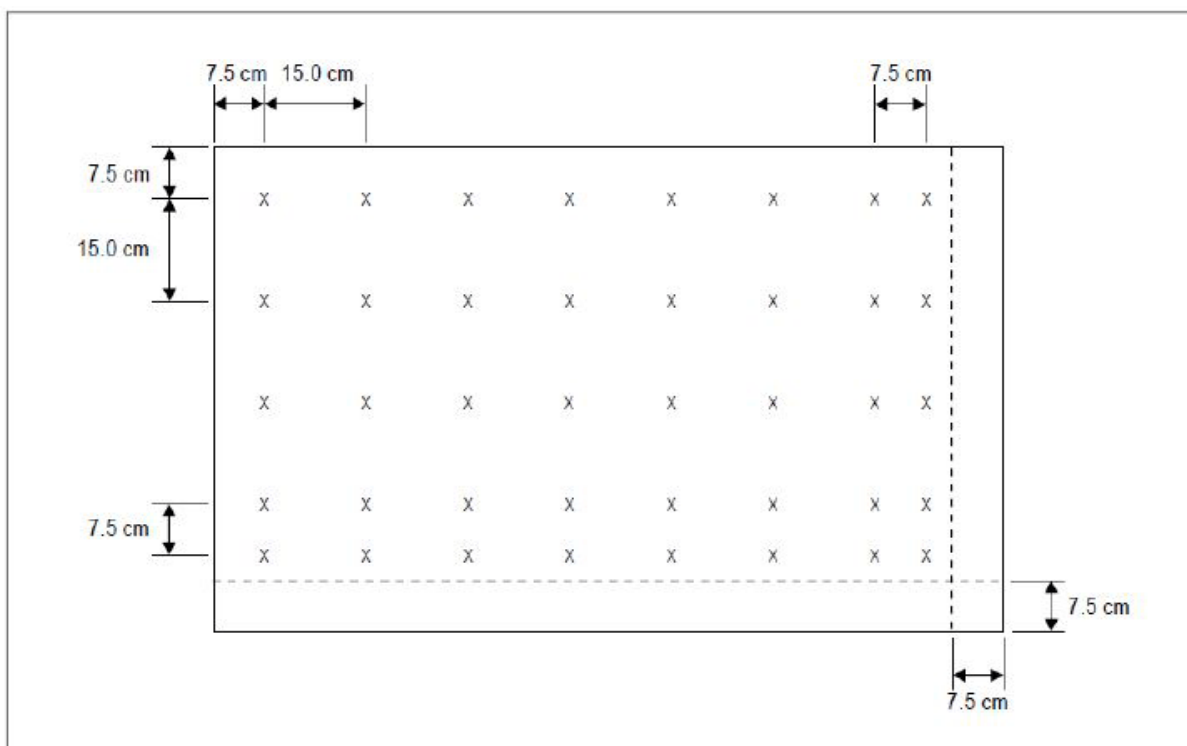
Note: In runway visual range conditions less than a value of 400 m, there will be some degradation in the performance of signs.

- (11) The luminance ratio between red and white elements of a mandatory instruction sign should be between 1:5 and 1:10.
- (12) The average luminance of the sign is calculated by establishing grid points as shown in Figure N-1, and using the luminance values measured at all grid points located within the rectangle representing the sign.
- (13) The average value is the arithmetic average of the luminance values measured at all considered grid points.
- (14) The ratio between luminance values of adjacent grid points should not exceed 1.5:1. For areas on the sign face where the grid spacing is 7.5 cm, the ratio between luminance values of adjacent grid points should not exceed 1.25:1. The ratio between the maximum and minimum luminance value over the whole sign face should not exceed 5:1.
- (15) The forms of characters, i.e. letters, numbers, arrows, and symbols should conform to those shown in Figures N-2A to N-2H. The width of characters and the space between individual characters should be determined as indicated in Table N-3.
- (16) The face height of signs should be as follows:

Legend height	Face height (min)
200 mm	400 mm
300 mm	600 mm
400 mm	800 mm

- (17) The face width of signs should be determined using Figure N-3 except that, where a mandatory instruction sign is provided on one side of a taxiway only, the face width should not be less than:
  - (i) 1.94 m where the code number is 3 or 4; and
  - (ii) 1.46 m where the code number is 1 or 2.
- (18) Borders:
  - (i) The black vertical delineator between adjacent direction signs should have a width of approximately 0.7 of the stroke width.
  - (ii) The yellow border on a stand-alone location sign should be approximately 0.5 stroke width.
- (19) The colours of signs should be in accordance with the appropriate specifications in CHAPTER U — Colours for aeronautical ground lights, markings, signs and panels.
- (20) If instruction or information during a certain period of time, and/or there is a need to display variable pre-determined information, a variable information sign should be provided.
  - (i) A variable message sign should show a blank face when not in use.
  - (ii) In case of failure, a variable message sign should not provide information that could lead to unsafe action from a pilot or a vehicle driver.
  - (iii) The time interval to change from one message to another on a variable message sign should be as short as practicable and should not exceed 5 seconds.

If the runway threshold is displaced from the extremity of the runway, a sign showing the designation of the runway may be provided for aeroplanes taking off.



Note 1: The average luminance of a sign is calculated by establishing grid points on a sign face showing typical inscriptions and a background of the appropriate colour (red for mandatory instruction signs and yellow for direction and destination signs) as follows:

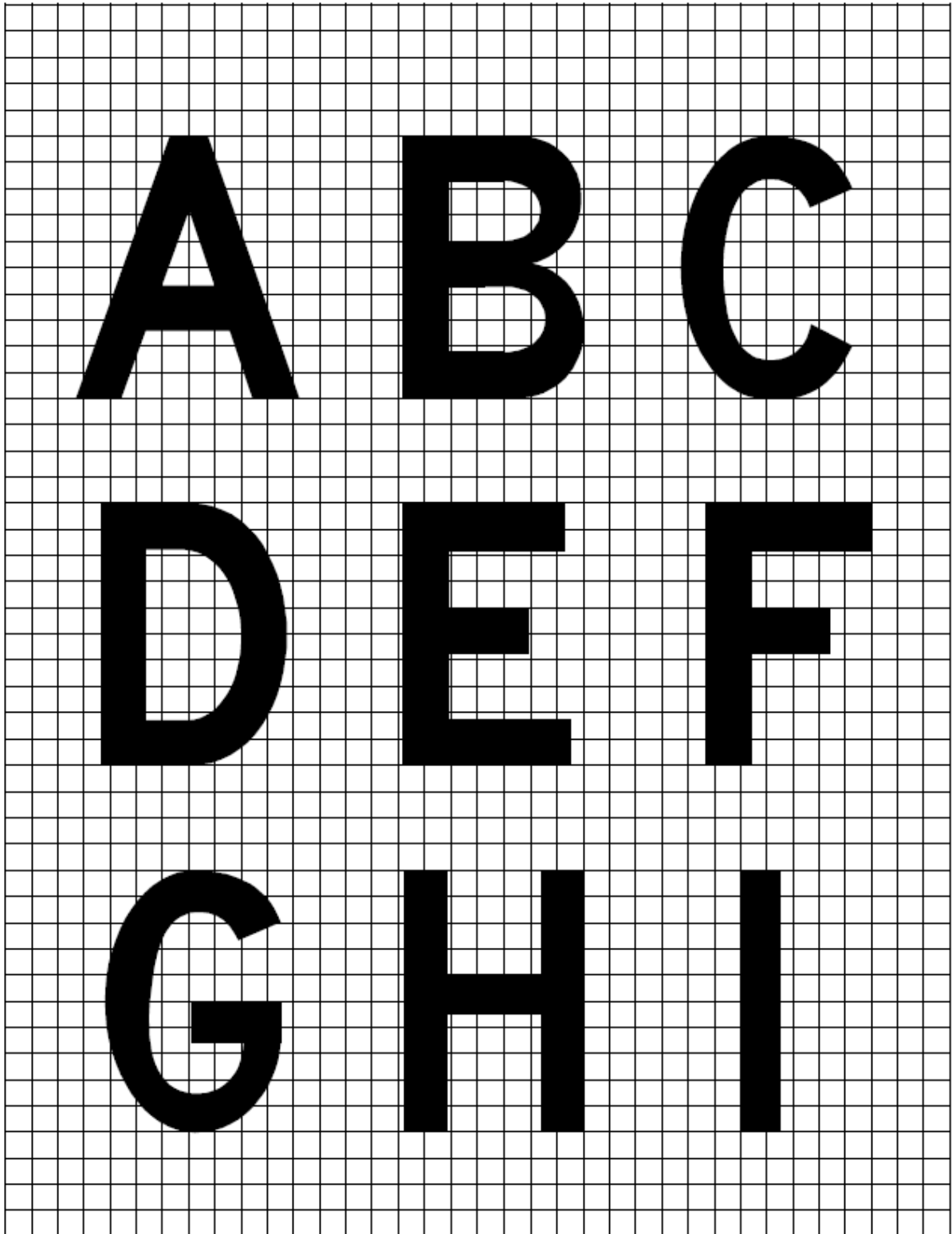
- Starting at the top left corner of the sign face, establish a reference grid point at 7.5 cm from the left edge and the top of the sign face.
- Create a grid of 15 cm spacing horizontally and vertically from the reference grid point. Grid points within 7.5 cm of the edge of the sign face should be excluded.
- Where the last point in a row/column of grid points is located between 22.5 cm and 15 cm from the edge of the sign face (but not inclusive), an additional point should be added 7.5 cm from this point.
- Where a grid point falls on the boundary of a character and the background, the grid point should be slightly shifted to be completely outside the character.

Note 2: Additional grid points may be required to ensure that each character includes at least five evenly spaced grid points.

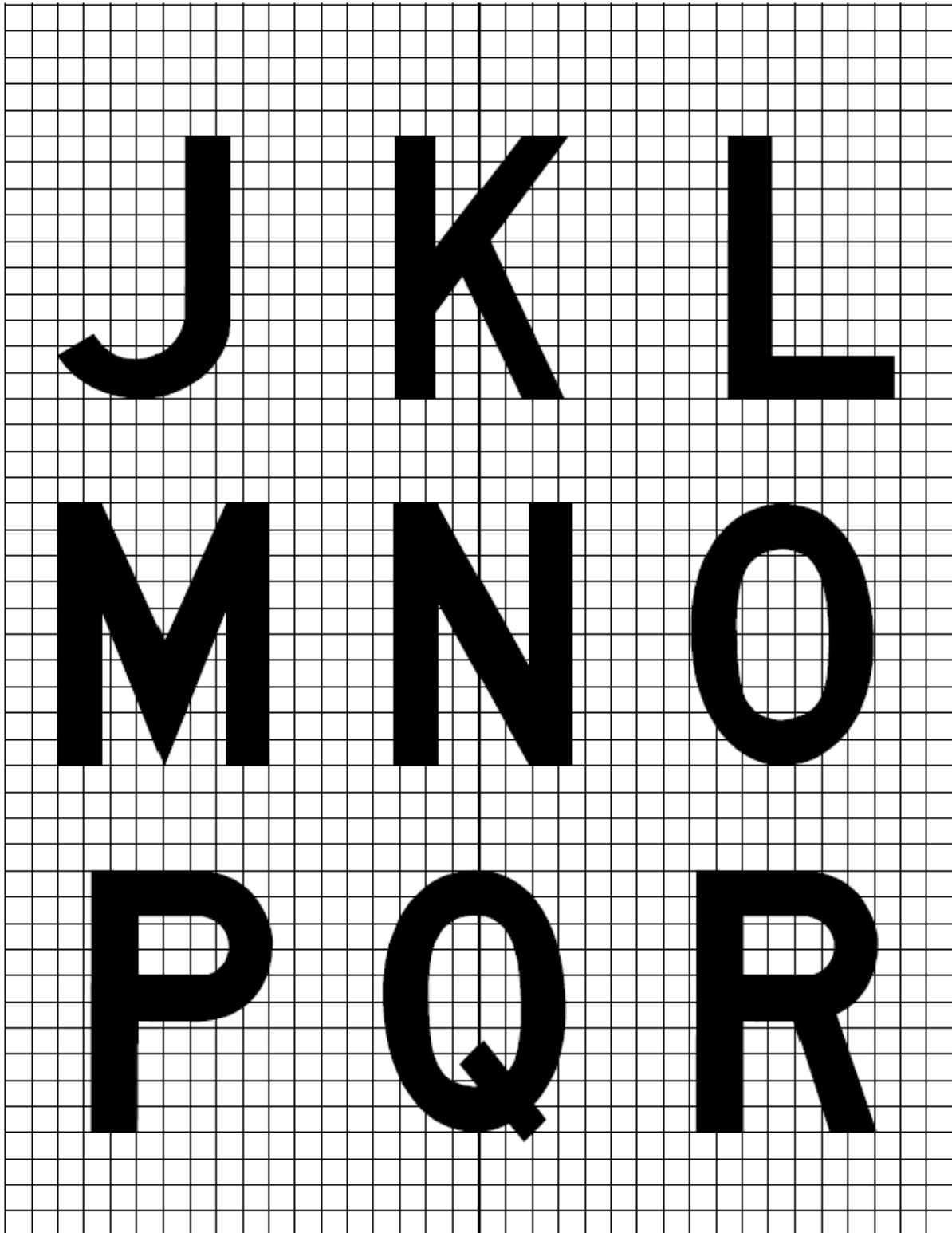
Note 3: Where one unit includes two types of signs, a separate grid should be established for each type.

**Figure N-1. Grid points for calculating average luminance of a sign**

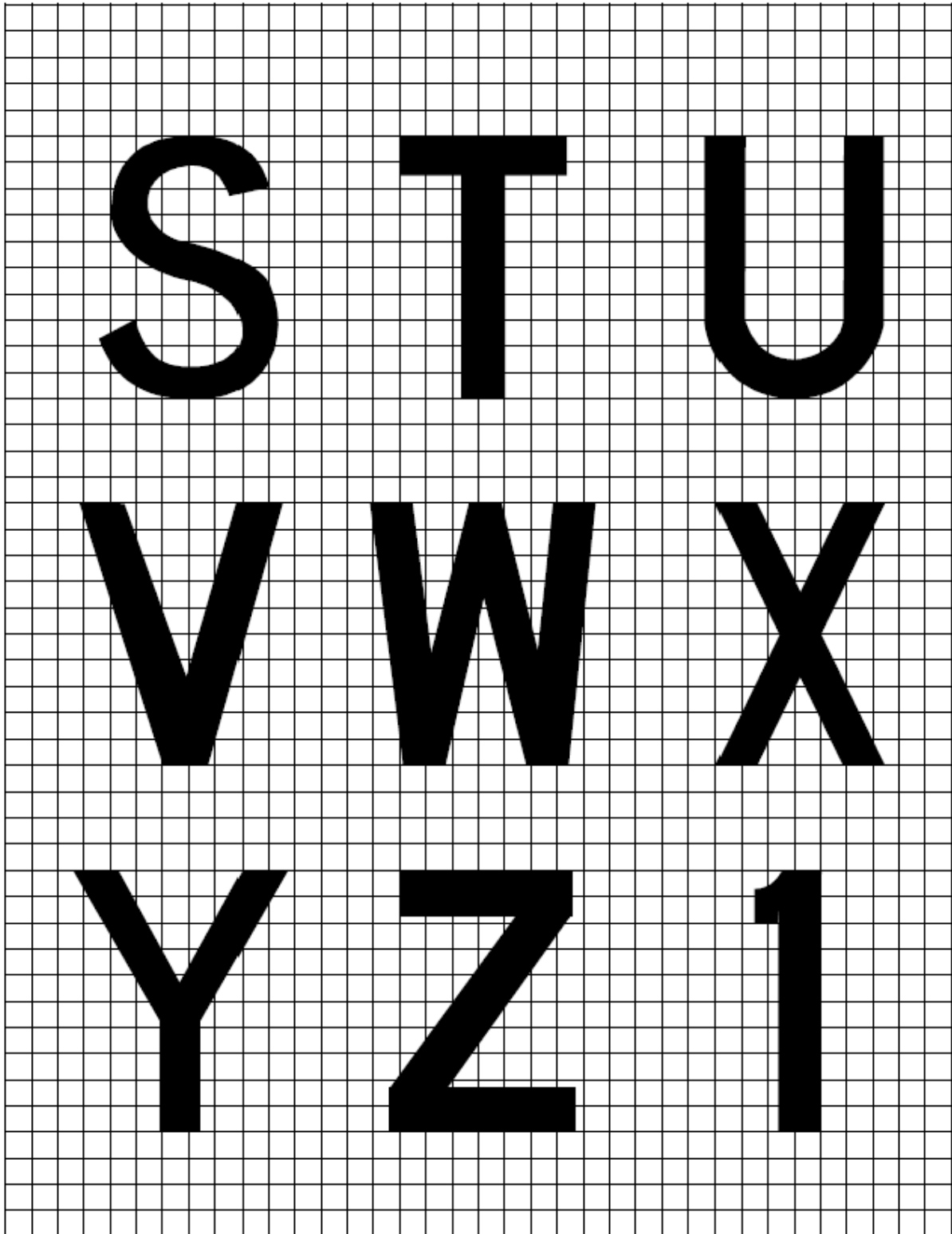




*Figure N-2A. Forms of characters for signs*



*Figure N-2B. Forms of characters for signs*



*Figure N-2C. Forms of characters for signs*

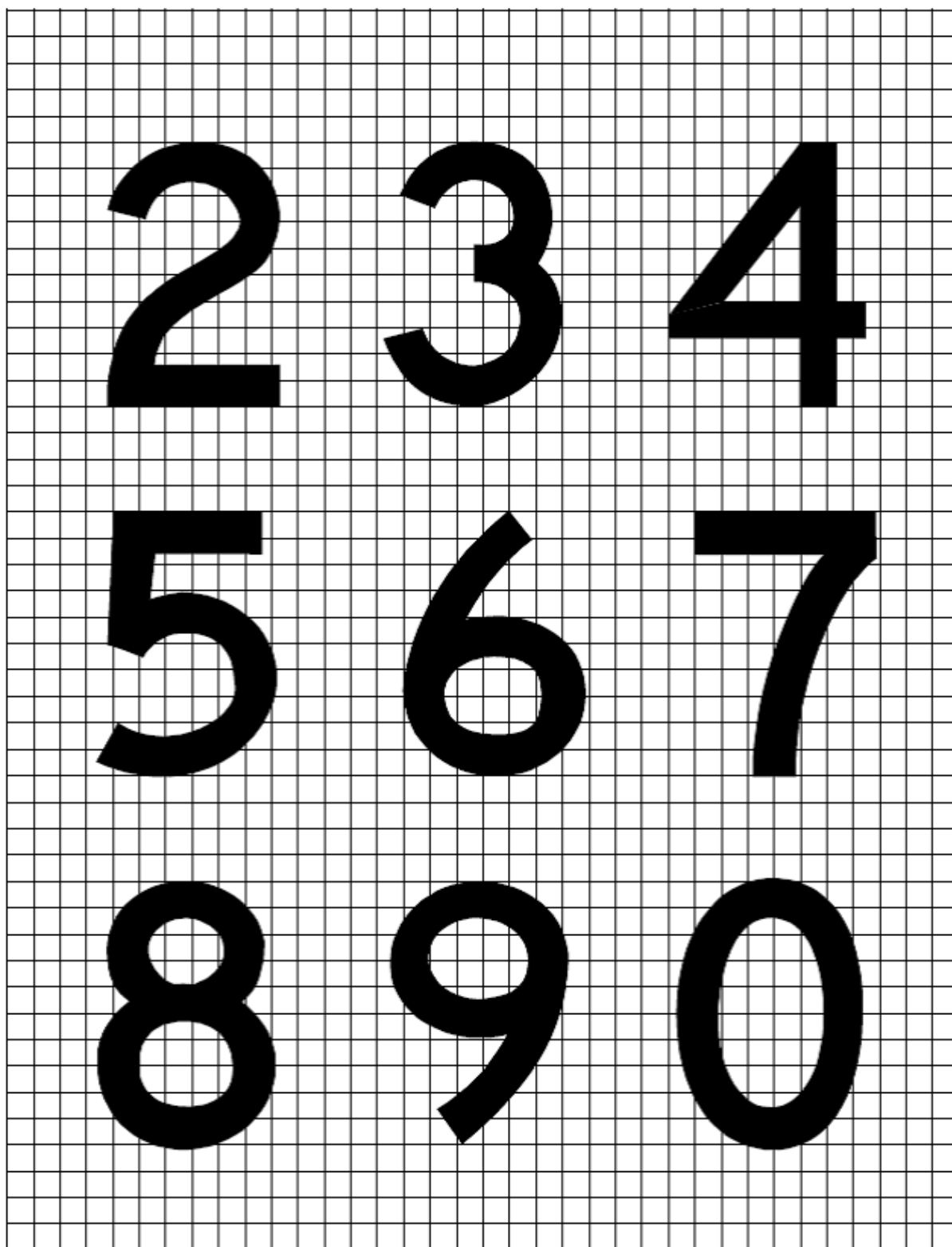
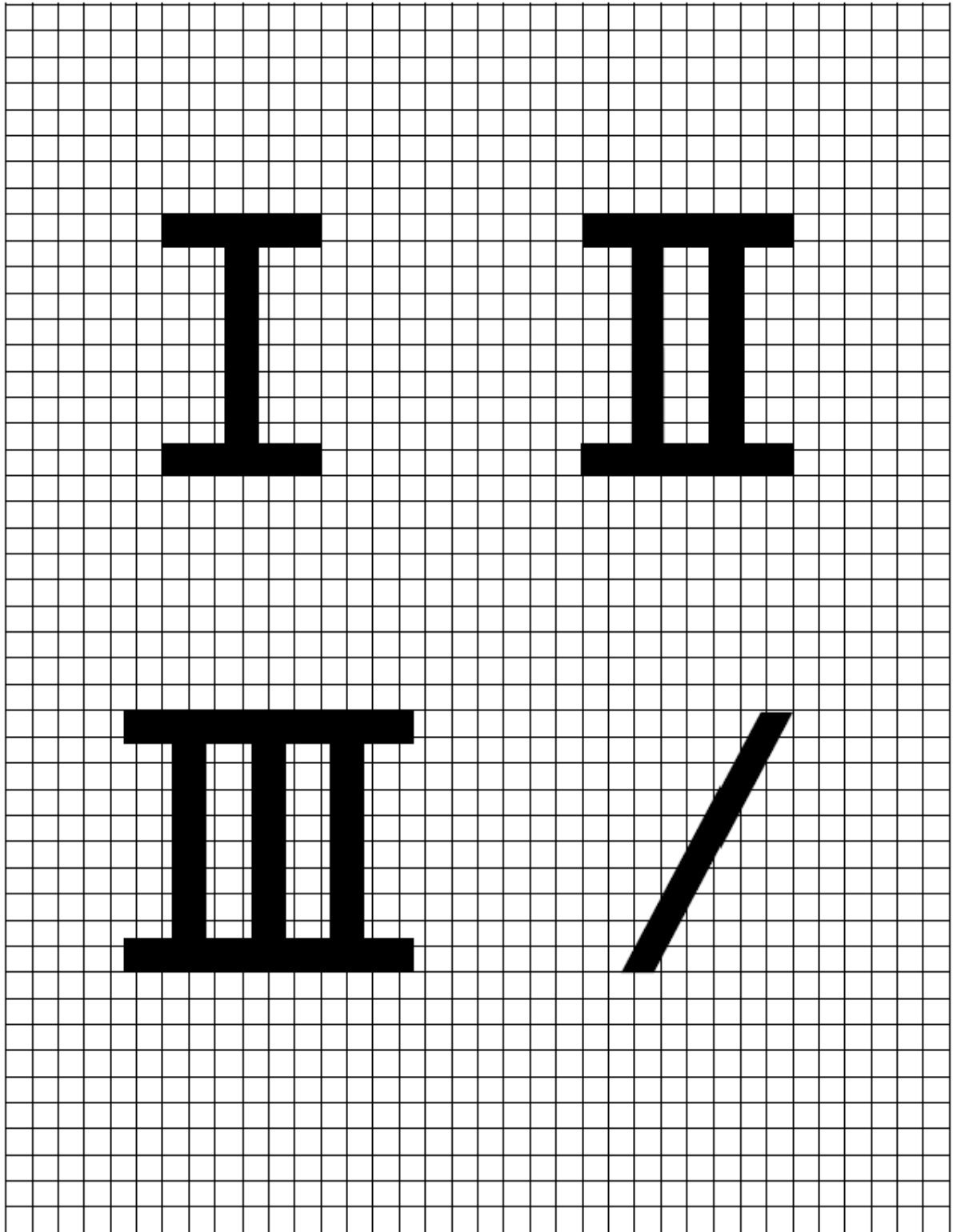


Figure N-2D. Forms of characters for signs



*Figure N-2E. Forms of characters for signs*

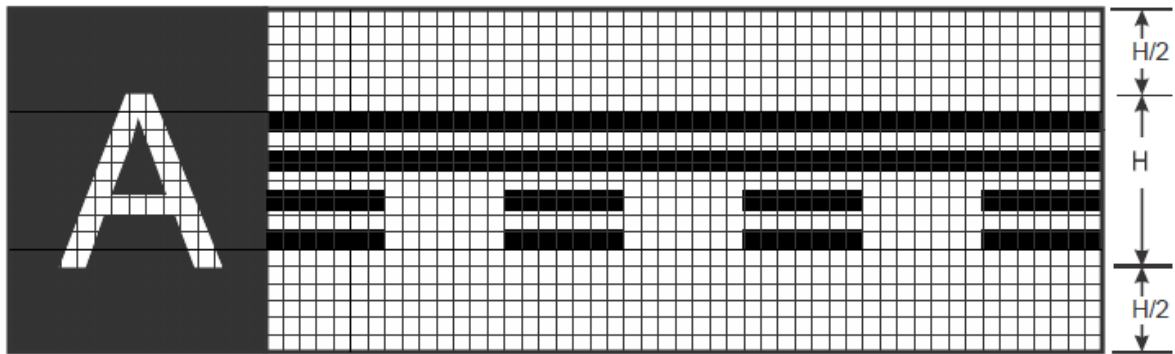


Figure N-2F. Runway vacated sign with typical location sign

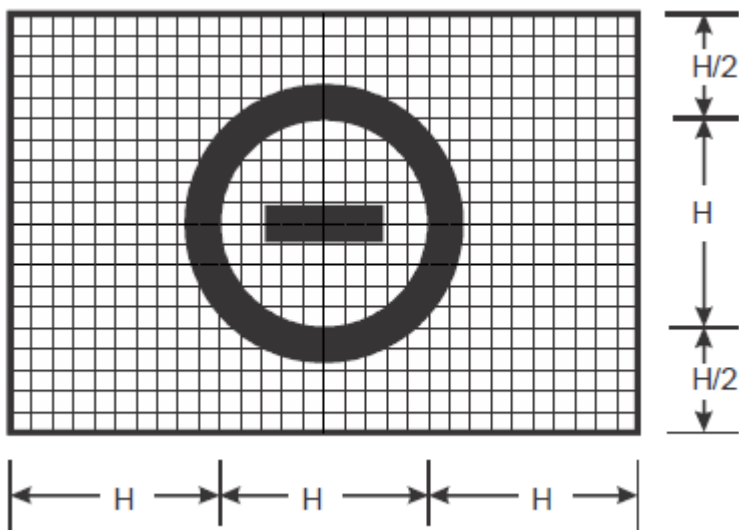
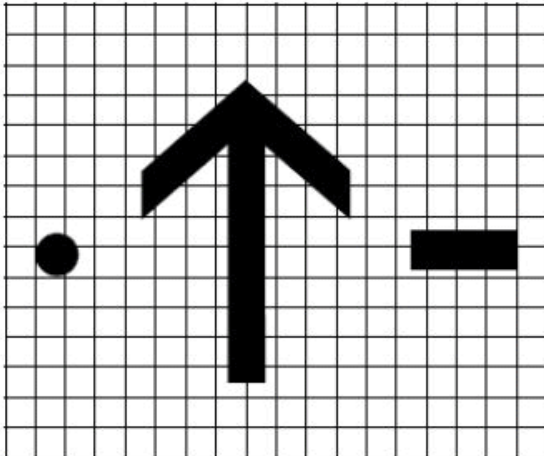


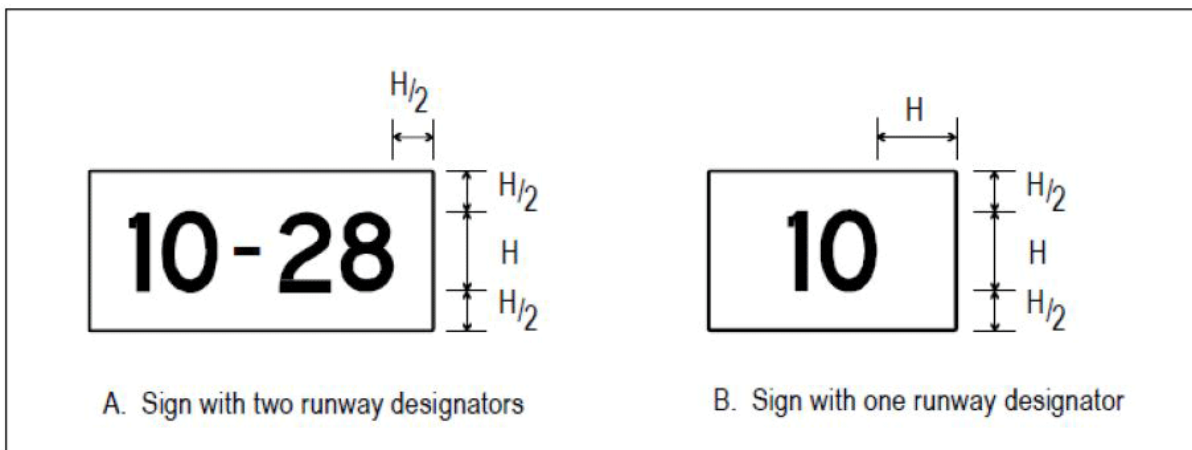
Figure N-2G. No entry sign



**Figure N-2H. Forms of characters for signs**

Note 1. — The arrow stroke width, diameter of the dot, and both width and length of the dash should be proportioned to the character stroke widths.

Note 2. — The dimensions of the arrow should remain constant for a particular sign size, regardless of orientation.



**Figure N-3. Sign dimensions**

a) Letter to letter code number			
Preceding Letter	Following Letter		
	B, D, E, F, H, I, K, L, M, N, P, R, U	C, G, O, Q, S, X, Z	A, J, T, V, W, Y
	Code number		
A	2	2	4
B	1	2	2
C	2	2	3
D	1	2	2
E	2	2	3
F	2	2	3
G	1	2	2
H	1	1	2
I	1	1	2
J	1	1	2
K	2	2	3
L	2	2	4
M	1	1	2
N	1	1	2
O	1	2	2
P	1	2	2
Q	1	2	2
R	1	2	2
S	1	2	2
T	2	2	4
U	1	1	2
V	2	2	4
W	2	2	4
X	2	2	3
Y	2	2	4
Z	2	2	3

b) Numeral to numeral code number			
Preceding Numeral	Following number		
	1, 5	2, 3, 6, 8, 9, 0	4, 7
	Code number		
1	1	1	2
2	1	2	2
3	1	2	2
4	2	2	4
5	1	2	2
6	1	2	2
7	2	2	4
8	1	2	2
9	1	2	2
0	1	2	2



c) Space between characters			
Code No.	Character height (mm)		
	200	300	400
	Space (mm)		
1	48	71	96
2	38	57	76
3	25	38	50
4	13	19	26

d) Width of letter			
Letter	Letter height (mm)		
	200	300	400
	Width (mm)		
A	170	255	340
B	137	205	274
C	137	205	274
D	137	205	274
E	124	186	248
F	124	186	248
G	137	205	274
H	137	205	274
I	32	48	64
J	127	190	254
K	140	210	280
L	124	186	248
M	157	236	314
N	137	205	274
O	143	214	286
P	137	205	274
Q	143	214	286
R	137	205	274
S	137	205	274
T	124	186	248
U	137	205	274
V	152	229	304
W	178	267	356
X	137	205	274
Y	171	257	342
Z	137	205	274

e) Width of numeral			
Code No.	Numeral height (mm)		
	200	300	400
Width (mm)			
1	50	74	98
2	137	205	274
3	137	205	274
4	149	224	298
5	137	205	274
6	137	205	274
7	137	205	274
8	137	205	274
9	137	205	274
0	143	214	286

#### INSTRUCTIONS

- To determine the proper SPACE between letters or numerals, obtain the code number from table a) or b) and enter table c) for that code number to the desired letter or numeral height.
- The space between words or groups of characters forming an abbreviation or symbol should be equal to 0.5 to 0.75 of the height of the characters used except that where an arrow is located with a single character such as 'A→', the space may be reduced to not less than one quarter of the height of the character in order to provide a good visual balance.
- Where the numeral follows a letter or vice versa, use Code 1.
- Where a hyphen, dot, or diagonal stroke follows a character or vice versa, use Code 1.
- For the intersection take-off sign, the height of the lower case 'm' is 0.75 of the height of the preceding character. The spacing from the preceding character is at Code 1 for the character height in Table N-3(c).

**Table N-3. Letter and numeral width and space between letters or numerals**

[Issue: ADR-DSN/3]

[Issue: ADR-DSN/4]

## GM1 ADR-DSN.N.775 General

ED Decision 2016/027/R

- Signs may need to be orientated to improve readability.
- If the runway threshold is displaced from the extremity of the runway, a sign showing the designation of the runway may be provided for aeroplanes taking off.
- Guidance on signs is contained in ICAO Doc 9157, Aerodrome Design Manual, Part 4, Visual Aids, Chapter 11.
- Guidance on frangibility is contained in ICAO Doc 9157, Aerodrome Design Manual, Part 6, Frangibility.
- Guidance on measuring the average luminance of a sign is contained in ICAO Doc 9157, Aerodrome Design Manual, Part 4, Visual Aids.

[Issue: ADR-DSN/3]

## **CS ADR-DSN.N.780 Mandatory instruction signs**

*ED Decision 2017/021/R*

(a) **Applicability:**

- (1) A mandatory instruction sign should be provided to identify a location beyond which an aircraft taxiing or vehicle should not proceed unless authorised by the aerodrome control tower.
- (2) Mandatory instruction signs should include runway designation signs, Category I, II, or III holding position signs, runway-holding position signs, road-holding position signs, and NO ENTRY signs.
- (3) A pattern 'A' runway-holding position marking should be supplemented at a taxiway/runway intersection or a runway/runway intersection with a runway designation sign.
- (4) A pattern 'B' runway-holding position marking should be supplemented with a Category I, II, or III holding position sign.
- (5) A pattern 'A' runway-holding position marking at a runway-holding position should be supplemented with a runway-holding position sign.
- (6) A runway designation sign at a taxiway/runway intersection should be supplemented with a location sign in the outboard (farthest from the taxiway) position as appropriate.
- (7) A road-holding position sign should be provided at all road entrances to a runway and may also be provided at road entrances to taxiways.
- (8) A NO ENTRY sign should be provided when entry into an area is prohibited.










(b) **Location:**

- (1) A runway designation sign at a taxiway/runway intersection or a runway/runway intersection should be located on each side of the runway-holding position marking facing the direction of approach to the runway.
- (2) A Category I, II, or III holding position sign should be located on each side of the runway-holding position marking facing the direction of the approach to the critical area.
- (3) A NO ENTRY sign should be located at the beginning of the area to which entrance is prohibited on each side of the taxiway as viewed by the pilot.
- (4) A runway-holding position sign should be located on each side of the runway-holding position facing the approach to the obstacle limitation surface or ILS/MLS critical/sensitive area as appropriate.

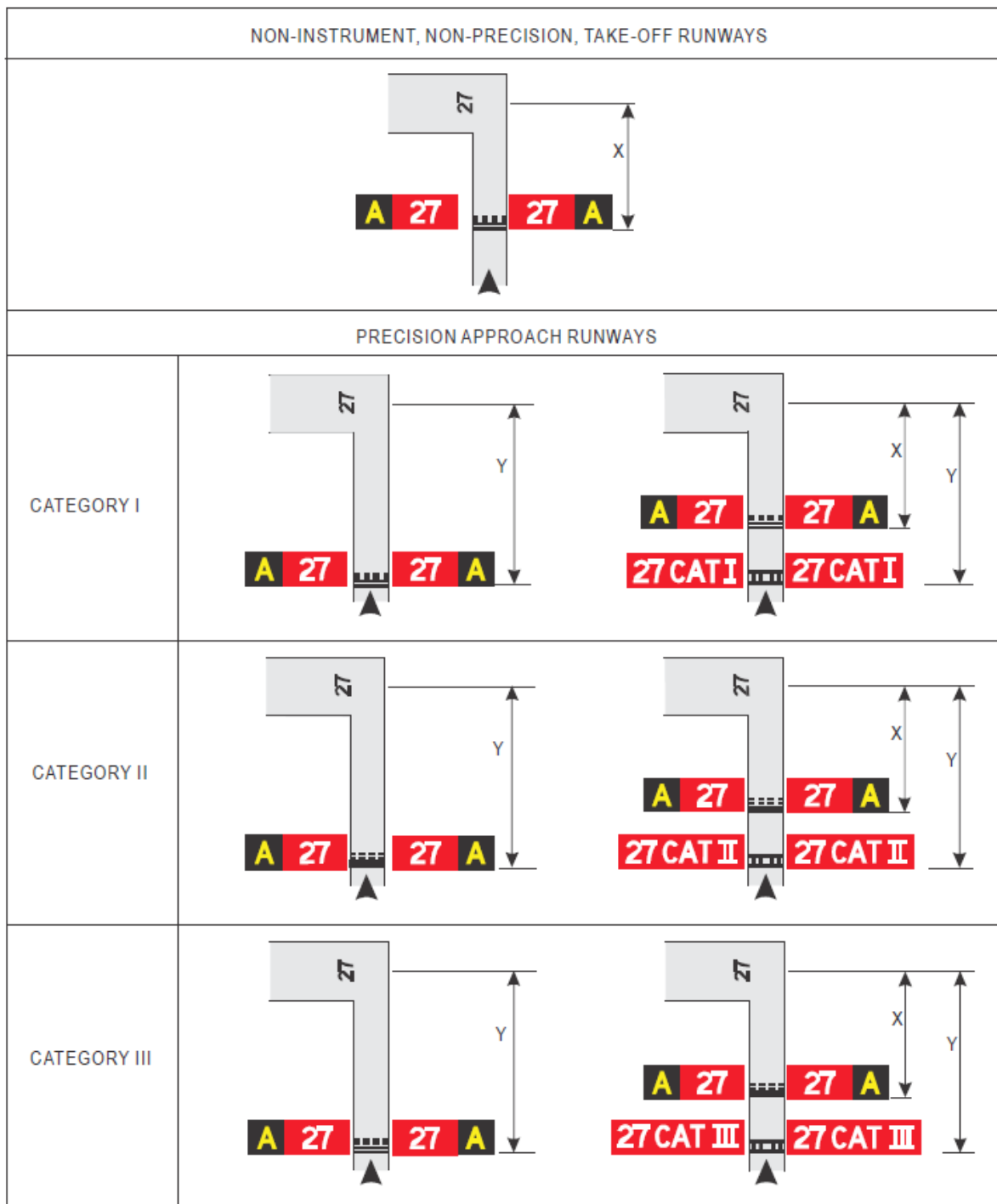
(c) **Characteristics:**

- (1) A mandatory instruction sign should consist of an inscription in white on a red background. Where, owing to environmental or other factors, the conspicuity of the inscription on a mandatory instruction sign needs to be enhanced, the outside edge of the white inscription should be supplemented by a black outline measuring 10 mm in width for runway code numbers 1 and 2, and 20 mm in width for runway code numbers 3 and 4.
- (2) The inscription on a runway designation sign should consist of the runway designations of the intersecting runway properly oriented with respect to the viewing position of the

- sign, except that a runway designation sign installed in the vicinity of a runway extremity may show the runway designation of the concerned runway extremity only.
- (3) The inscription on a Category I, II, III, joint II/III or joint I/II/III holding position sign should consist of the runway designator followed by CAT I, CAT II, CAT III, CAT II/III or CAT I/II/III, as appropriate.
  - (4) The inscription on a NO ENTRY sign should be in accordance with Figure N-4.
  - (5) The inscription on a runway-holding position sign at a runway-holding position should consist of the taxiway designation and a number.
- (d) Where installed, the inscriptions/symbol of Figure N-4 should be used:

Runway designation of a runway extremity (Example)		Indicates a runway-holding position at a runway extremity
Runway designation of both extremities of a runway (Example)		Indicates a runway-holding position located at taxiway/runway intersection other than runway extremity
Category I hold position (Example)		Indicates a category I runway-holding position at the threshold of runway 25
Category II hold position (Example)		Indicates a category II runway-holding position at the threshold of runway 25
Category III hold position (Example)		Indicates a category III runway-holding position at the threshold of runway 25
Category II and III hold position (Example)		Indicates a joint category II and III runway-holding position at the threshold of runway 25
Category I, II and III hold position (Example)		Indicates a joint category I, II and III runway-holding position at the threshold of runway 25
NO ENTRY		Indicates that entry to an area is prohibited
Runway-holding position (Example)		Indicates a runway-holding position (in accordance with CS ADR-DSN.D.335(b)(1))

**Figure N-4. Mandatory instruction signs**



Note: Distance X is established in accordance with Table D-2. Distance Y is established at the edge of ILS/MLS critical/sensitive area

Figure N-5. Positions of signs at taxiway/runway intersections

[Issue: ADR-DSN/3]

[Issue: ADR-DSN/4]

## GM1 ADR-DSN.N.780 Mandatory instruction signs

ED Decision 2014/013/R

intentionally left blank

## CS ADR-DSN.N.785 Information signs

*ED Decision 2017/021/R*

(a) Applicability:

- (1) An information sign should be provided where there is an operational need to identify by a sign, a specific location, or routing (direction or destination) information.
- (2) Information signs should include: direction signs, location signs, destination signs, runway exit signs, runway vacated signs, and intersection take-off signs.
- (3) A runway exit sign should be provided where there is an operational need to identify a runway exit.
- (4) A runway vacated sign should be provided where the exit taxiway is not provided with taxiway centre line lights and there is a need to indicate to a pilot leaving a runway the perimeter of the ILS/MLS critical/sensitive area, or the lower edge of the inner transitional surface whichever is farther from the runway centre line.
- (5) At runways where intersection take-offs are conducted, an intersection take-off sign should be provided to indicate the remaining take-off run available (TORA) for such take-offs.
- (6) Where necessary, a destination sign should be provided to indicate the direction to a specific destination on the aerodrome, such as cargo area, general aviation, etc.
- (7) A combined location and direction sign should be provided when it is intended to indicate routing information prior to a taxiway intersection.
- (8) A direction sign should be provided when there is an operational need to identify the designation and direction of taxiways at an intersection.
- (9) A location sign should be provided at an intermediate holding position.
- (10) A location sign should be provided in conjunction with a runway designation sign except at a runway/runway intersection.
- (11) A location sign should be provided in conjunction with a direction sign, except that it may be omitted where a safety assessment indicates that it is not needed.
- (12) Where necessary, a location sign should be provided to identify taxiways exiting an apron or taxiways beyond an intersection.
- (13) Where a taxiway ends at an intersection such as a 'T' and it is necessary to identify this, a barricade, direction sign, and/or other appropriate visual aid should be used.

(b) Location:

- (1) Except as specified in paragraph (b)(3) below, information signs should wherever practicable, be located on the left-hand side of the taxiway in accordance with Table N-1.
- (2) At a taxiway intersection, information signs should be located prior to the intersection and in line with the intermediate holding position marking. Where there is no intermediate holding position marking, the signs should be installed at least 60 m from the centre line of the intersecting taxiway where the code number is 3 or 4, and at least 40 m where the code number is 1 or 2.
- (3) A runway exit sign should be located on the same side of the runway as the exit is located (i.e. left or right), and positioned in accordance with Table N-1.

- (4) A runway exit sign should be located prior to the runway exit point in line with a position at least 60 m prior to the point of tangency where the code number is 3 or 4, and at least 30 m where the code number is 1 or 2.
  - (5) A runway vacated sign should be located at least on one side of the taxiway. The distance between the sign and the centre line of a runway should be not less than the greater of the following:
    - (i) the distance between the centre line of the runway and the perimeter of the ILS/MLS critical/sensitive area; or
    - (ii) the distance between the centre line of the runway and the lower edge of the inner transitional surface.
  - (6) Where provided in conjunction with a runway vacated sign, the taxiway location sign should be positioned outboard of the runway vacated sign.
  - (7) An intersection take-off sign should be located at the left-hand side of the entry taxiway. The distance between the sign and the centre line of the runway should be not less than 60 m where the code number is 3 or 4 and not less than 45 m where the code number is 1 or 2.
  - (8) A taxiway location sign installed in conjunction with a runway designation sign should be positioned outboard of the runway designation sign.
  - (9) A destination sign should not normally be collocated with a location or direction sign.
  - (10) An information sign other than a location sign should not be collocated with a mandatory instruction sign.
- (c) Characteristics:
- (1) An information sign other than a location sign should consist of an inscription in black on a yellow background.
  - (2) A location sign should consist of an inscription in yellow on a black background and where it is a stand-alone sign, should have a yellow border.
  - (3) The inscription on a runway exit sign should consist of the designator of the exit taxiway and an arrow indicating the direction to follow.
  - (4) The inscription on a runway vacated sign should depict the pattern A runway-holding position marking as shown in Figure N-6.
  - (5) The inscription on an intersection take-off sign should consist of a numerical message indicating the remaining take-off run available in metres, plus an arrow, appropriately located and oriented, indicating the direction of the take-off as shown in Figure N-6.
  - (6) The inscription on a destination sign should comprise an alpha, alphanumerical or numerical message identifying the destination, plus an arrow indicating the direction to proceed as shown in Figure N-6.
  - (7) The inscription on a direction sign should comprise an alpha or alphanumerical message identifying the taxiway(s), plus an arrow or arrows appropriately oriented as shown in Figure N-6.
  - (8) The inscription on a location sign should comprise the designation of the location taxiway, runway, or other pavement the aircraft is on or is entering, and should not contain arrows.

- 
- (9) Where necessary to identify each of a series of intermediate holding positions on the same taxiway, the location sign should consist of the taxiway designation and a progressive number.
  - (10) Where a location sign and direction signs are used in combination:
    - (i) all direction signs related to left turns should be placed on the left side of the location sign and all direction signs related to right turns should be placed on the right side of the location sign, except that where the junction consists of one intersecting taxiway, the location sign may alternatively be placed on the left hand side;
    - (ii) the direction signs should be placed such that the direction of the arrows departs increasingly from the vertical with increasing deviation of the corresponding taxiway;
    - (iii) an appropriate direction sign should be placed next to the location sign where the direction of the location taxiway changes significantly beyond the intersection; and
    - (iv) adjacent direction signs should be delineated by a vertical black line as shown in Figure N-6.
  - (11) A taxiway should be identified by a designator comprising a letter, letters, or a combination of a letter or letters followed by a number.
  - (12) When designating taxiways, the use of the letters I, O, or X, and the use of words such as 'inner' and 'outer' should be avoided wherever possible, to avoid confusion with the numerals 1, 0, and closed marking.
  - (13) The use of numbers alone on the manoeuvring area should be reserved for the designation of runways.



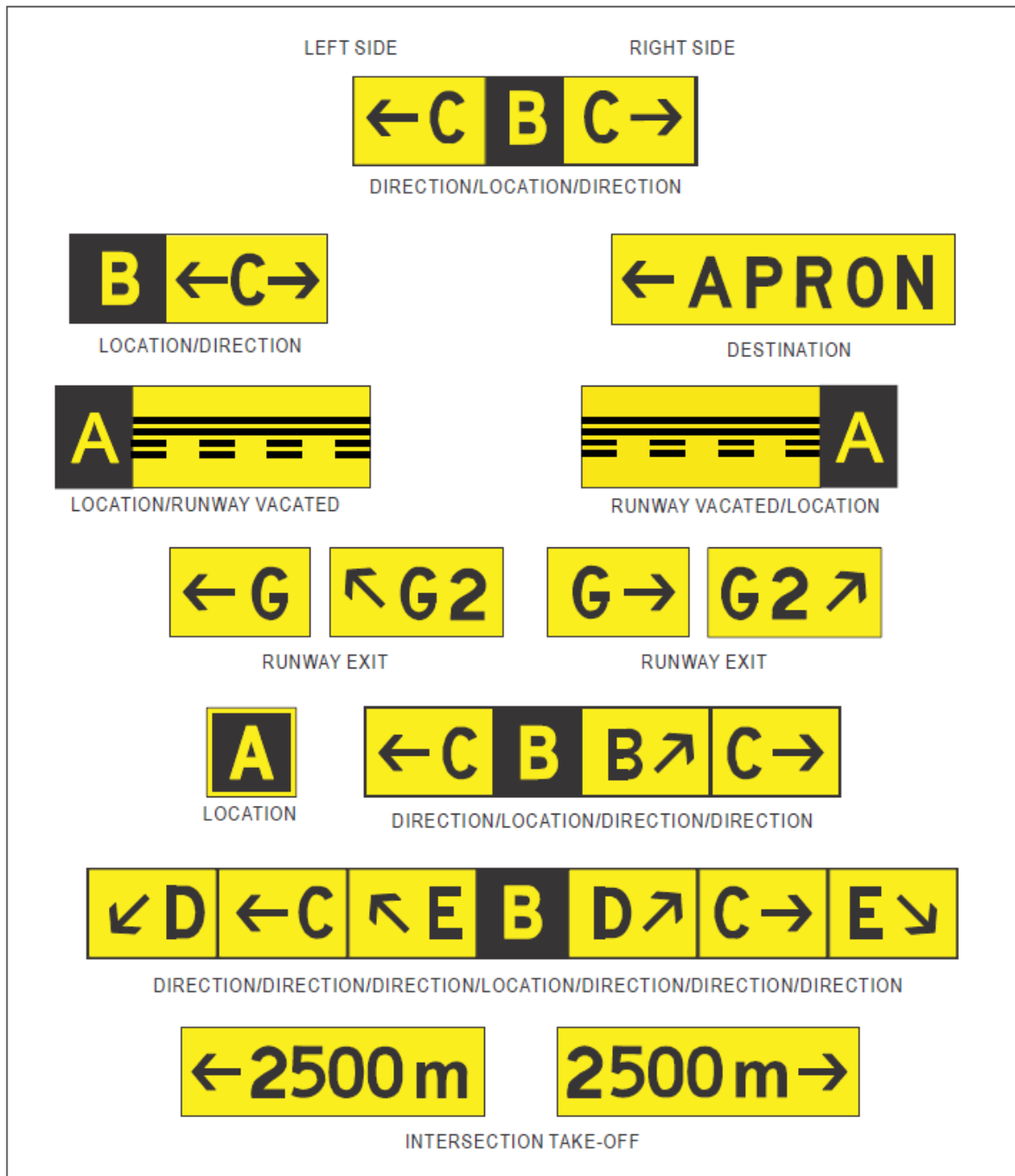


Figure N-6. Information signs

[Issue: ADR-DSN/3]

[Issue: ADR-DSN/4]

## GM1 ADR-DSN.N.785 Information signs

ED Decision 2016/027/R

- (a) When an installation of information sign on the left-hand side is not possible, e.g. due to infrastructural or operational restrictions, an installation on the right-hand side of the taxiway in accordance with the specifications given in Table N-1 may also be acceptable when a safety assessment indicates that it would not adversely affect the safety of operations of aeroplanes.

- (b) At a 'T' intersection, information signs may be located in the direction of the taxiway centre line to the opposite side of the crossing taxiway when a safety assessment indicates that guidance could be assured under all intended operating conditions and that it would not adversely affect the safety of operations of aeroplanes.

[Issue: ADR-DSN/3]

## CS ADR-DSN.N.790 VOR aerodrome checkpoint sign

ED Decision 2014/013/R

When a VOR aerodrome check-point is established, it should be indicated by a VOR aerodrome check-point marking and sign.

- (a) Location: A VOR aerodrome check-point sign should be located as near as possible to the check-point and so that the inscriptions are visible from the cockpit of an aircraft properly positioned on the VOR aerodrome check-point marking.
- (b) Characteristics:
- (1) A VOR aerodrome check-point sign should consist of an inscription in black on a yellow background.
  - (2) The inscriptions on a VOR check-point sign should be in accordance with one of the alternatives shown in Figure N-7 in which:

VOR	is an abbreviation identifying this as a VOR check-point;
116.3	is an example of the radio frequency of the VOR concerned;
147°	is an example of the VOR bearing, to the nearest degree, which should be indicated at the VOR check-point; and
4.3 NM	is an example of the distance in nautical miles to a DME collocated with the VOR concerned.

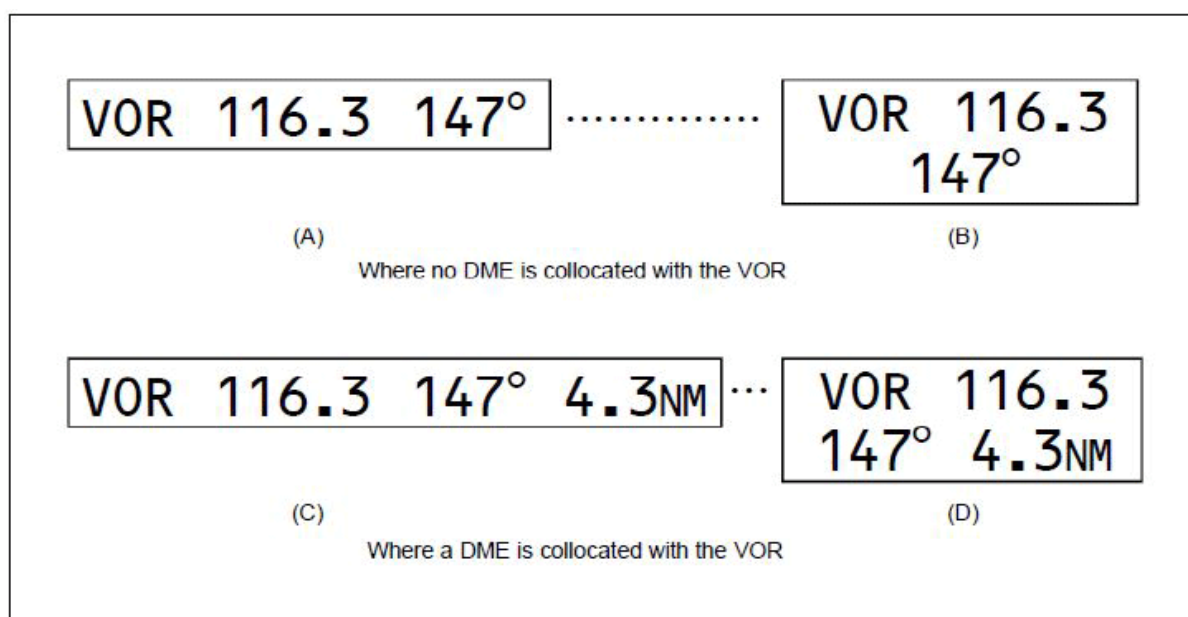


Figure N-7. VOR aerodrome check-point sign

## GM1 ADR-DSN.N.790 VOR aerodrome checkpoint sign

ED Decision 2014/013/R

intentionally left blank

## CS ADR-DSN.N.795 Aircraft stand identification signs

ED Decision 2017/021/R

- (a) **Applicability:** An aircraft stand identification marking should be supplemented with an aircraft stand identification sign where feasible.
- (b) **Location:** An aircraft stand identification sign should be located so as to be clearly visible from the cockpit of an aircraft prior to entering the aircraft stand.
- (c) **Characteristics:** An aircraft stand identification sign should consist of an inscription in black on a yellow background.

[Issue: ADR-DSN/4]

## GM1 ADR-DSN.N.795 Aircraft stand identification signs

ED Decision 2014/013/R

intentionally left blank

## CS ADR-DSN.N.800 Road-holding position sign

ED Decision 2017/021/R

- (a) **Applicability:** A road-holding position sign should be provided at all road entrances to a runway.
- (b) **Location:** The road-holding position sign should be located 1.5 m from one edge of the road (left or right as appropriate to the local road traffic regulations) at the holding position.
- (c) Where a road intersects a taxiway, a suitable sign may be located adjacent to the roadway/taxiway intersection marking 1.5 m from one edge of the road, i.e. left or right as appropriate to the local road traffic regulations.
- (d) **Characteristics:**
  - (1) A road-holding position sign at an intersection of a road with a runway should consist of an inscription in white on a red background.
  - (2) The inscription on a road-holding position sign should be in the national language, be in conformity with the local road traffic regulations, and include the following:
    - (i) a requirement to stop; and
    - (ii) where appropriate:
      - (A) a requirement to obtain ATC clearance; and
      - (B) location designator.
  - (3) A road-holding position sign intended for night use should be retroreflective or illuminated.
  - (4) A road-holding position sign at the intersection of a road with a taxiway should be in accordance with the local road traffic regulations for a yield right of way sign or a stop sign.

[Issue: ADR-DSN/4]

## **GM1 ADR-DSN.N.800 Road-holding position sign**

*ED Decision 2014/013/R*

intentionally left blank

## CHAPTER P — VISUAL AIDS FOR NAVIGATION (MARKERS)

### CS ADR-DSN.P.805 General

ED Decision 2014/013/R

Markers should be frangible. Those located near a runway or taxiway should be sufficiently low to preserve clearance for propellers, and for the engine pods of jet aircraft.

### GM1 ADR-DSN.P.805 General

ED Decision 2014/013/R

intentionally left blank

### CS ADR-DSN.P.810 Unpaved runway edge markers

ED Decision 2014/013/R

- (a) Applicability: Markers should be provided when the extent of an unpaved runway is not clearly indicated by the appearance of its surface compared with that of the surrounding ground.
- (b) Characteristics:
  - (1) Where runway lights are provided, the markers should be incorporated in the light fixtures. Where there are no lights, markers of flat rectangular or conical shape should be placed so as to delimit the runway clearly.
  - (2) The flat rectangular markers should have a minimum size of 1 m by 3 m, and should be placed with their long dimension parallel to the runway centre line. The conical markers should have a height not exceeding 0.50 m.

### GM1 ADR-DSN.P.810 Unpaved runway edge markers

ED Decision 2014/013/R

intentionally left blank

### CS ADR-DSN.P.815 Stopway edge markers

ED Decision 2014/013/R

- (a) Applicability: Stopway edge markers should be provided when the extent of a stopway is not clearly indicated by its appearance compared with that of the surrounding ground.
- (b) Characteristics: The stopway edge markers should be sufficiently different from any runway edge markers used to ensure that the two types of markers cannot be confused.

### GM1 ADR-DSN.P.815 Stopway edge markers

ED Decision 2014/013/R

intentionally left blank

## CS ADR-DSN.P.820 Edge markers for snow-covered runways

*ED Decision 2014/013/R*

- (a) **Applicability:** Edge markers for snow-covered runways should be used to indicate the usable limits of a snow-covered runway when the limits are not otherwise indicated.
- (b) **Location:** Edge markers for snow-covered runways should be placed along the sides of the runway at intervals of not more than 100 m, and should be located symmetrically about the runway centre line at such a distance from the centre line that there is adequate clearance for wing tips and powerplants. Sufficient markers should be placed across the threshold and end of the runway.

## GM1 ADR-DSN.P.820 Edge markers for snow-covered runways

*ED Decision 2016/027/R*

Characteristics: Runway lights could be used to indicate the limits.

[Issue: ADR-DSN/3]

## CS ADR-DSN.P.825 Taxiway edge markers

*ED Decision 2014/013/R*

- (a) **Applicability:** Taxiway edge markers should be provided on a taxiway where taxiway centre line or edge lights or taxiway centre line markers are not provided.
- (b) **Location:** Taxiway edge markers should be installed at least at the same locations as would the taxiway edge lights, had they been used.
- (c) **Characteristics:**
  - (1) A taxiway edge marker should be retroreflective blue.
  - (2) The marked surface as viewed by the pilot should be a rectangle and should have a minimum viewing area of 150 cm<sup>2</sup>.
  - (3) Taxiway edge markers should be frangible. Their height should be sufficiently low to preserve clearance for propellers and for the engine pods of jet aircraft.

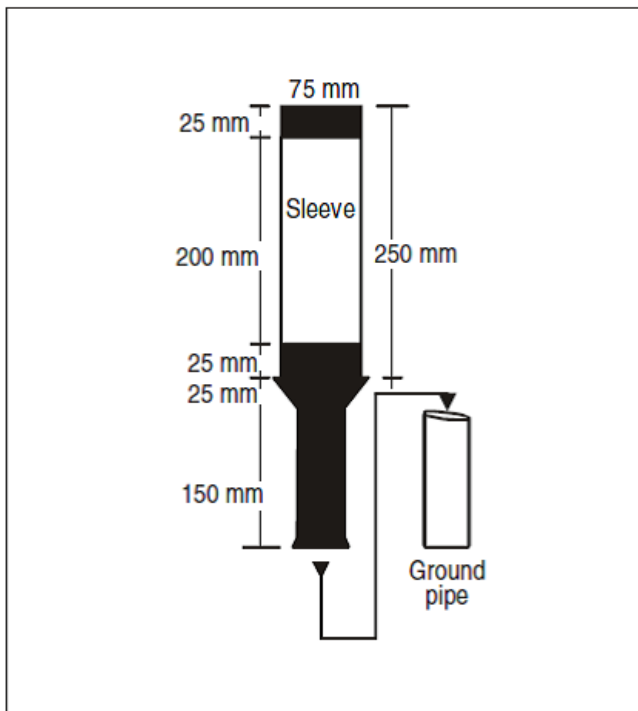
## GM1 ADR-DSN.P.825 Taxiway edge markers

*ED Decision 2017/021/R*

- (a) At small aerodromes, taxiway edge markers may be used, in lieu of taxiway edge lights, to delineate the edges of taxiways, particularly at night (ICAO Doc 9157, Aerodrome Design Manual, Part 4, Visual Aids, Chapter 2, paragraph 2.4.1).
- (b) On a straight section of a taxiway, taxiway edge markers should be spaced at uniform longitudinal intervals of not more than 60 m. On a curve the markers should be spaced at intervals less than 60 m so that a clear indication of the curve is provided. The markers should be located as near as practicable to the edges of the taxiway, or outside the edges at a distance of not more than 3 m. Additional guidance is given in ICAO Doc 9157, Aerodrome Design Manual, Part 4, Visual Aids, Chapter 2, paragraph 2.4.2.
- (c) The markers commonly used are cylindrical in shape. Ideally, the design of the marker should be such that when installed properly, no portion should exceed 35 cm total height above the mounting surface. However, where significant snow heights are possible, markers exceeding 35 cm in height may be used but their total height should be sufficiently low to preserve

clearance for propellers, and for the engine pods of jet aircraft. Additional guidance is given in ICAO Doc 9157, Aerodrome Design Manual, Part 4, Visual Aids, Chapter 2, paragraph 2.4.4.

- (d) A taxiway edge marker should be lightweight and frangible. One type of marker meeting these requirements is detailed in Figure GM-P-1. The post is made up of flexible PVC and its colour is blue. The sleeve which is retro-reflective, is also blue. Note that the area of the marked surface is 150 cm<sup>2</sup>. Additional guidance is given in ICAO Doc 9157, Aerodrome Design Manual, Part 4, Visual Aids, Chapter 2, paragraph 2.4.5.



**Figure GM-P-1. Taxiway edge marker**

[Issue: ADR-DSN/3]

[Issue: ADR-DSN/4]

## CS ADR-DSN.P.830 Taxiway centre line markers

*ED Decision 2014/013/R*

- (a) Applicability:
- (1) Taxiway centre line markers should be provided on a taxiway where taxiway centre line or edge lights or taxiway edge markers are not provided.
  - (2) Taxiway centre line markers should be provided on a taxiway where taxiway centre line lights are not provided if there is a need to improve the guidance provided by the taxiway centre line marking.
- (b) Location
- (1) Taxiway centre line markers should be installed at least at the same location as would taxiway centre line lights had they been used.
  - (2) Taxiway centre line markers should be located on the taxiway centre line marking except that they may be offset by not more than 0.3 m where it is not practicable to locate them on the marking.

(c) Characteristics:

- (1) A taxiway centre line marker should be retroreflective green.
- (2) The marked surface as viewed by the pilot should be a rectangle, and should have a minimum viewing area of 20 cm<sup>2</sup>.
- (3) Taxiway centre line markers should be so designed and fitted as to withstand being run over by the wheels of an aircraft without damage either to the aircraft or to the markers themselves.

## GM1 ADR-DSN.P.830 Taxiway centre line markers

*ED Decision 2014/013/R*

intentionally left blank

## CS ADR-DSN.P.835 Unpaved taxiway edge markers

*ED Decision 2014/013/R*

- (a) Applicability: Where the extent of an unpaved taxiway is not clearly indicated by its appearance compared with that of the surrounding ground, markers should be provided.
- (b) Characteristics:
  - (1) Where taxiway lights are provided, the markers should be incorporated in the light fixtures.
  - (2) Where there are no lights, suitable markers should be placed so as to clearly delineate the taxiway.

## GM1 ADR-DSN.P.835 Unpaved taxiway edge markers

*ED Decision 2014/013/R*

intentionally left blank



## CHAPTER Q — VISUAL AIDS FOR DENOTING OBSTACLES

### CS ADR-DSN.Q.840 Objects to be marked and/or lighted within the lateral boundaries of the obstacle limitation surfaces

ED Decision 2016/027/R

- (a) Applicability: The specifications for objects to be marked and/or lighted within the lateral boundaries of the obstacle limitation surfaces apply only to the area under control of the aerodrome operator.
- (b) Elevated aeronautical ground lights within the movement area should be marked so as to be conspicuous by day. Obstacle lights should not be installed on elevated ground lights or signs in the movement area.
- (c) All obstacles within the distance specified in Table D-1, column (11), (12) or (13), from the centre line of a taxiway, an apron taxiway or aircraft stand taxilane should be marked and, if the taxiway, apron taxiway or aircraft stand taxilane is used at night, lighted.
- (d) A fixed obstacle that extends above a take-off climb, approach or transitional surface within 3 000 m of the inner edge of the take-off climb or approach surface should be marked and if the runway is used at night, lighted, except that:
  - (1) such marking and lighting may be omitted when the obstacle is shielded by another fixed obstacle;
  - (2) the marking may be omitted when the obstacle is lighted by medium-intensity obstacle lights, Type A, by day, and its height above the level of the surrounding ground does not exceed 150 m;
  - (3) the marking may be omitted when the obstacle is lighted by high-intensity obstacle lights by day if medium intensity lights, Type A, are deemed insufficient; and
  - (4) the lighting may be omitted where the obstacle is a lighthouse and an safety assessment indicates the lighthouse light to be sufficient.
- (e) A fixed object, other than an obstacle, adjacent to a take-off climb, approach or transitional surface should be marked and, if the runway is used at night, lighted, if such marking and lighting is considered necessary to ensure its avoidance, except that the marking may be omitted when:
  - (1) the object is lighted by medium-intensity obstacle lights, Type A, by day, and its height above the level of the surrounding ground does not exceed 150 m; or
  - (2) the object is lighted by high-intensity obstacle lights by day if medium intensity lights, Type A, are deemed insufficient.
- (f) A fixed obstacle that extends above a horizontal surface should be marked and if the aerodrome is used at night, lighted, except that:
  - (1) such marking and lighting may be omitted when:
    - (i) the obstacle is shielded by another fixed obstacle; or
    - (ii) for a circuit extensively obstructed by immovable objects or terrain, procedures have been established to ensure safe vertical clearance below prescribed flight paths; or
    - (iii) an safety assessment shows the obstacle is not of operational significance.

- (2) the marking may be omitted when the obstacle is lighted by medium-intensity obstacle lights, Type A, by day, and its height above the level of the surrounding ground does not exceed 150 m;
  - (3) the marking may be omitted when the obstacle is lighted by high-intensity obstacle lights by day if medium intensity lights, Type A, are deemed insufficient; and
  - (4) the lighting may be omitted where the obstacle is a lighthouse and a safety assessment indicates the lighthouse light to be sufficient.
- (g) A fixed object that extends above an obstacle protection surface should be marked and, if the runway is used at night, lighted, except that such marking and lighting may be omitted when the obstacle is shielded by another fixed obstacle.

[Issue: ADR-DSN/3]

### **GM1 ADR-DSN.Q.840 Objects to be marked and/or lighted within the lateral boundaries of the obstacle limitation surfaces**

*ED Decision 2016/027/R*

- (a) The marking and/or lighting of obstacles is intended to reduce hazards to aircraft by indicating the presence of the obstacles. It does not necessarily reduce operating limitations which may be imposed by an obstacle.
- (b) Other objects inside the obstacle limitation surfaces should be marked and/or lighted if a safety assessment indicates that the object could constitute a hazard to aircraft (this includes objects adjacent to visual routes e.g. waterway or highway).
- (c) Overhead wires, cables, etc., crossing a river, waterway, valley or highway should be marked and their supporting towers marked and lighted if a safety assessment indicates that the wires or cables could constitute a hazard to aircraft.

[Issue: ADR-DSN/3]

### **CS ADR-DSN.Q.841 Objects to be marked and/or lighted outside the lateral boundaries of the obstacle limitation surfaces**

*ED Decision 2016/027/R*

- (a) **Applicability:** The specifications for objects to be marked and/or lighted outside the lateral boundaries of the obstacle limitation surfaces apply only to the area under control of the aerodrome operator.
- (b) Obstacles in accordance with [CS ADR-DSN.J.487](#) should be marked and lighted, except that the marking may be omitted when the obstacle is lighted by high-intensity obstacle lights by day.
- (c) When considered as an obstacle, other objects outside the obstacle limitation surfaces should be marked and/or lighted.

[Issue: ADR-DSN/3]

## GM1 ADR-DSN.Q.841 Objects to be marked and/or lighted outside the lateral boundaries of the obstacle limitation surfaces

ED Decision 2016/027/R

- (a) Other objects outside the obstacle limitation surfaces should be marked and/or lighted if a safety assessment indicates that the object could constitute a hazard to aircraft (this includes objects adjacent to visual routes e.g. waterway, highway).
- (b) Overhead wires, cables, etc., crossing a river, waterway, valley or highway should be marked and their supporting towers marked and lighted if a safety assessment indicates that the wires or cables could constitute a hazard to aircraft.

[Issue: ADR-DSN/3]

## CS ADR-DSN.Q.845 Marking of fixed objects

ED Decision 2016/027/R

- (a) General: All fixed objects to be marked should, whenever practicable, be coloured but if this is not practicable, markers or flags should be displayed on or above them, except those objects that are sufficiently conspicuous by their shape, size, or colour need not be otherwise marked.
- (b) Marking by colour
  - (1) An object should be coloured to show a chequered pattern if it has essentially unbroken surfaces, and its projection on any vertical plane equals or exceeds 4.5 m in both dimensions. The pattern should consist of rectangles of not less than 1.5 m and not more than 3 m on a side, the corners being of the darker colour. The colours of the pattern should contrast with each other and with the background against which they should be seen.
  - (2) An object should be coloured to show alternating contrasting bands if:
    - (i) it has essentially unbroken surfaces, and has one dimension, horizontal or vertical, greater than 1.5 m, and the other dimension, horizontal or vertical, less than 4.5 m; or
    - (ii) it is of skeletal type with either a vertical or a horizontal dimension greater than 1.5 m.
  - (3) The bands should be perpendicular to the longest dimension and have a width approximately 1/7 of the longest dimension or 30 m, whichever is less. The colours of the bands should contrast with the background against which they should be seen. Orange and white should be used, except where such colours are not conspicuous when viewed against the background. The bands on the extremities of the object should be of the darker colour (see Figures Q-1 and Q-2). The dimensions of the marking band widths are shown in Table Q-4.
  - (4) An object should be coloured in a single conspicuous colour if its projection on any vertical plane has both dimensions less than 1.5 m. Orange or red should be used, except where such colours merge with the background.
- (c) Marking by flags
  - (1) Flags used to mark fixed objects should be displayed around, on top of, or around the highest edge of the object. When flags are used to mark extensive objects or groups of

closely spaced objects, they should be displayed at least every 15 m. Flags should not increase the hazard presented by the object they mark.

- (2) Flags used to mark fixed objects should not be less than 0.6 m on each side.
  - (3) Flags used to mark fixed objects should be orange in colour or a combination of two triangular sections, one orange and the other white, or one red and the other white. Except where such colours merge with the background, other conspicuous colours should be used.
- (d) Marking by markers
- (1) Markers displayed on or adjacent to objects should be located in conspicuous positions so as to retain the general definition of the object and should be recognisable in clear weather from a distance of at least 1 000 m for an object to be viewed from the air and 300 m for an object to be viewed from the ground in all directions in which an aircraft is likely to approach the object. The shape of markers should be distinctive to the extent necessary to ensure that they are not mistaken for markers employed to convey other information, and they should be such that the hazard presented by the object they mark is not increased.
  - (2) A marker should be of one colour. When more than one markers are installed, white and red, or white and orange markers should be displayed alternately. The colour selected should contrast with the background against which it should be seen.

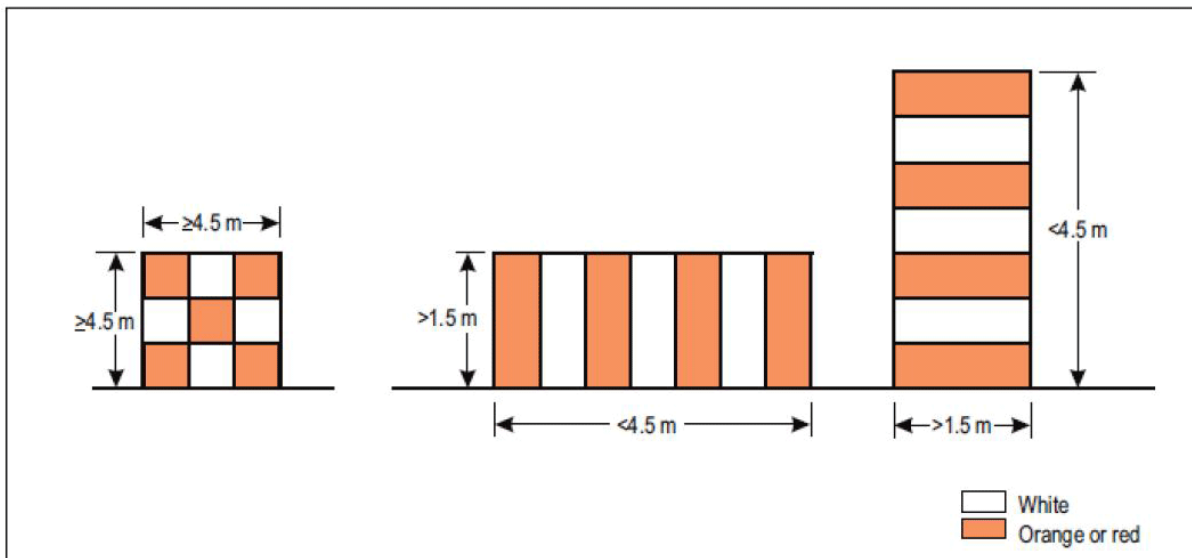


Figure Q-1. Basic marking patterns

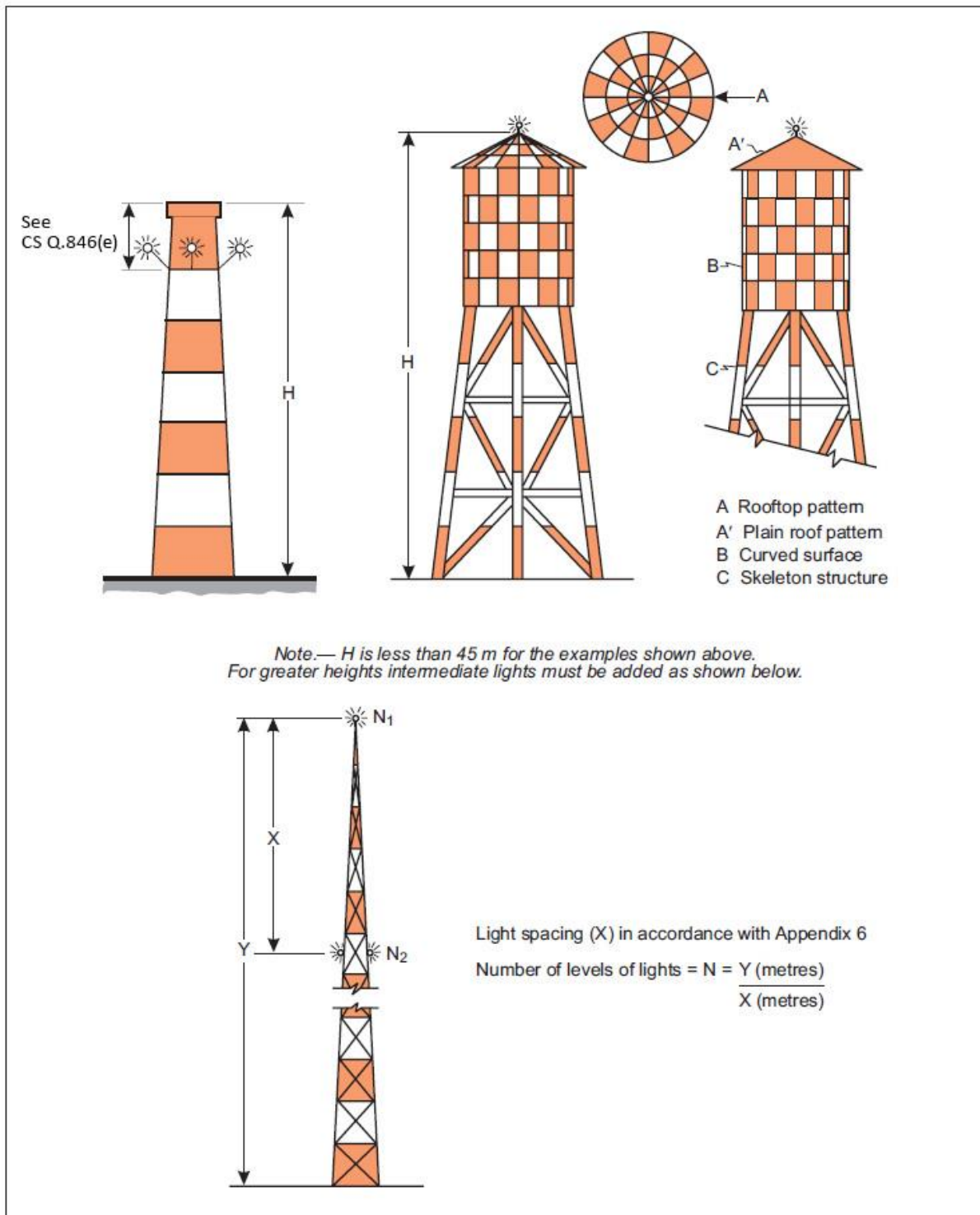


Figure Q-2. Examples of marking and lighting of tall structures

[Issue: ADR-DSN/3]

## GM1 ADR-DSN.Q.845 Marking of fixed objects

ED Decision 2016/027/R

- (a) Orange and white or alternatively red and white are preferably used, except where such colours merge with the background.

- (b) Table Q-4 shows a formula for determining band widths, and for having an odd number of bands, thus permitting both the top and bottom bands to be of the darker colour.
- (c) Against some backgrounds it may be found necessary to use a different colour from orange or red to obtain sufficient contrast.
- (d) Alternative spacing may be suitable; priority is to highlight the location and definition of the object.

[Issue: ADR-DSN/3]

## CS ADR-DSN.Q.846 Lighting of fixed objects

ED Decision 2017/021/R

- (a) The presence of objects which should be lighted, as specified in [CS ADR-DSN.Q.840](#) and [CS ADR-DSN.Q.841](#) should be indicated by low-, medium- or high-intensity obstacle lights, or a combination of such lights.
- (b) Low-intensity obstacle lights, Types A, B, C and D, medium-intensity obstacle lights, Types A, B and C and high-intensity obstacle lights Types A and B, should be in accordance with the specifications in Table Q-1, [CS ADR-DSN.U.930](#) and Figure U-1A or U-1B, as appropriate..
- (c) The number and arrangement of low-, medium- or high-intensity obstacle lights at each level to be marked should be such that the object is indicated from every angle in azimuth. Where a light is shielded in any direction by another part of the object or by an adjacent object, additional lights should be provided on that adjacent object, or the part of the object that is shielding the light, in such a way as to retain the general definition of the object to be lighted. If the shielded light does not contribute to the definition of the object to be lighted, it may be omitted.
- (d) In case of an object to be lighted one or more low-, medium- or high-intensity obstacle lights should be located as close as practicable to the top of the object.
- (e) In the case of chimney or other structure of like function, the top lights should be placed sufficiently below the top so as to minimise contamination by smoke, etc. (see Figure Q-2).
- (f) In the case of a tower or antenna structure indicated by high-intensity obstacle lights by day with an appurtenance such as a rod or an antenna greater than 12 m where it is not practicable to locate a high-intensity obstacle light on the top of the appurtenance, such a light should be located at the highest practicable point, and, if practicable, a medium-intensity obstacle light, Type A, mounted on the top.
- (g) In the case of an extensive object or of a group of closely spaced objects to be lighted that are:
  - (1) Penetrating a horizontal obstacle limitation surface (OLS) or located outside an OLS, the top lights should be so arranged as to at least indicate the points or edges of the object highest in relation to OLS or above the ground, and so as to indicate the general definition and the extent of the objects; and
  - (2) Penetrating a sloping OLS, the top lights should be so arranged as to at least indicate the points or edges of the object highest in relation to the OLS, and so as to indicate the general definition and the extent of the objects. If two or more edges are of the same height, the edge nearest the landing area should be marked.
- (h) When the obstacle limitation surface concerned is sloping and the highest point above the obstacle limitation surface is not the highest point of the object, additional obstacle lights should be placed on the highest point of the object.

- (i) Where lights are applied to display the general definition of an extensive object or a group of closely spaced objects, and
  - (1) Low-intensity lights are used, they should be spaced at longitudinal intervals not exceeding 45 m.
  - (2) Medium-intensity lights are used, they should be spaced at longitudinal intervals not exceeding 900 m.
- (j) High-intensity obstacle lights, Type A, and medium-intensity obstacle lights, Types A and B, located on an object should flash simultaneously.
- (k) The installation setting angles for high-intensity obstacle lights, Type A, should be in accordance with Table Q-5.

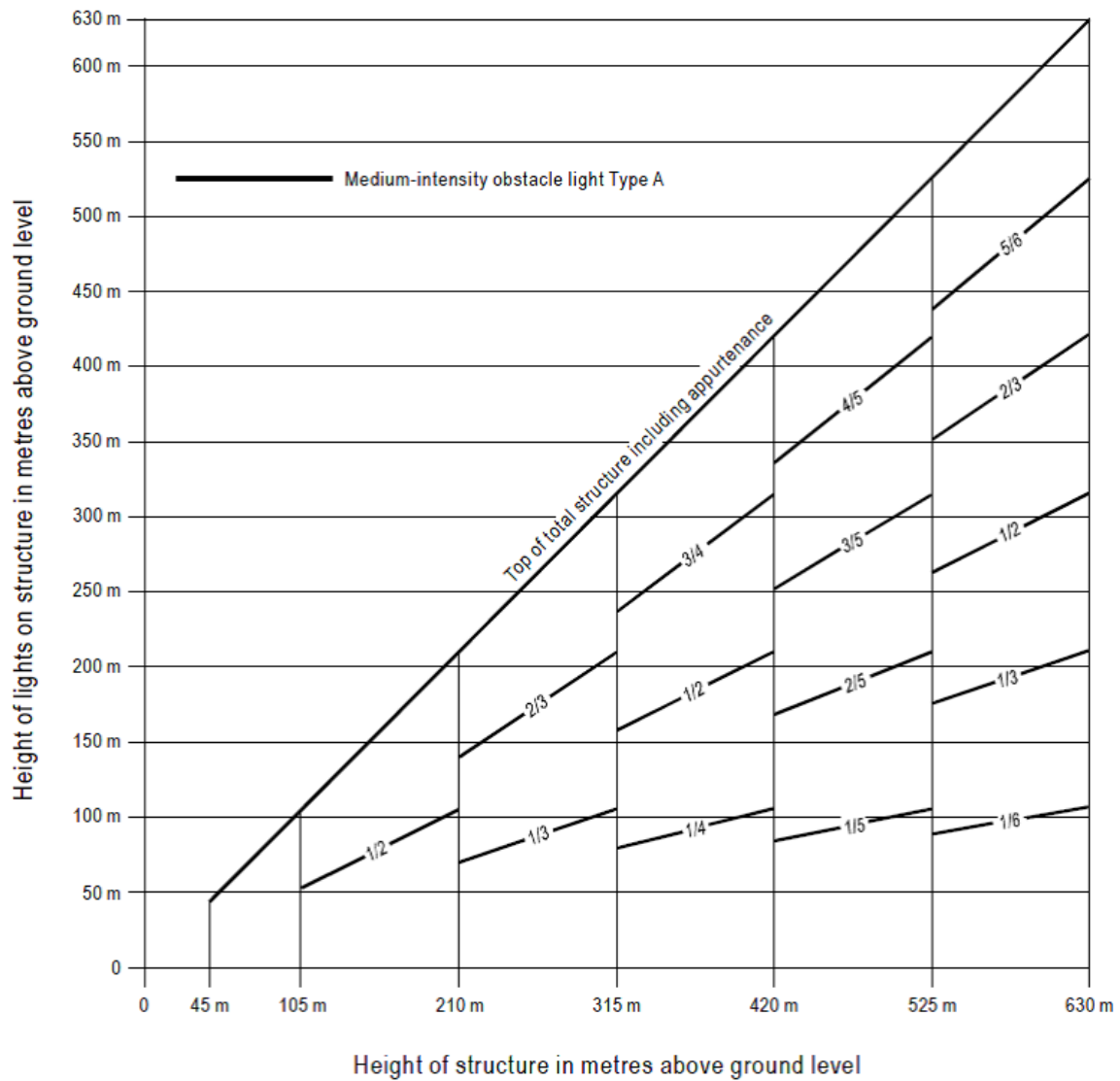
[Issue: ADR-DSN/3]

[Issue: ADR-DSN/4]

## GM1 ADR-DSN.Q.846 Lighting of fixed objects

ED Decision 2016/027/R

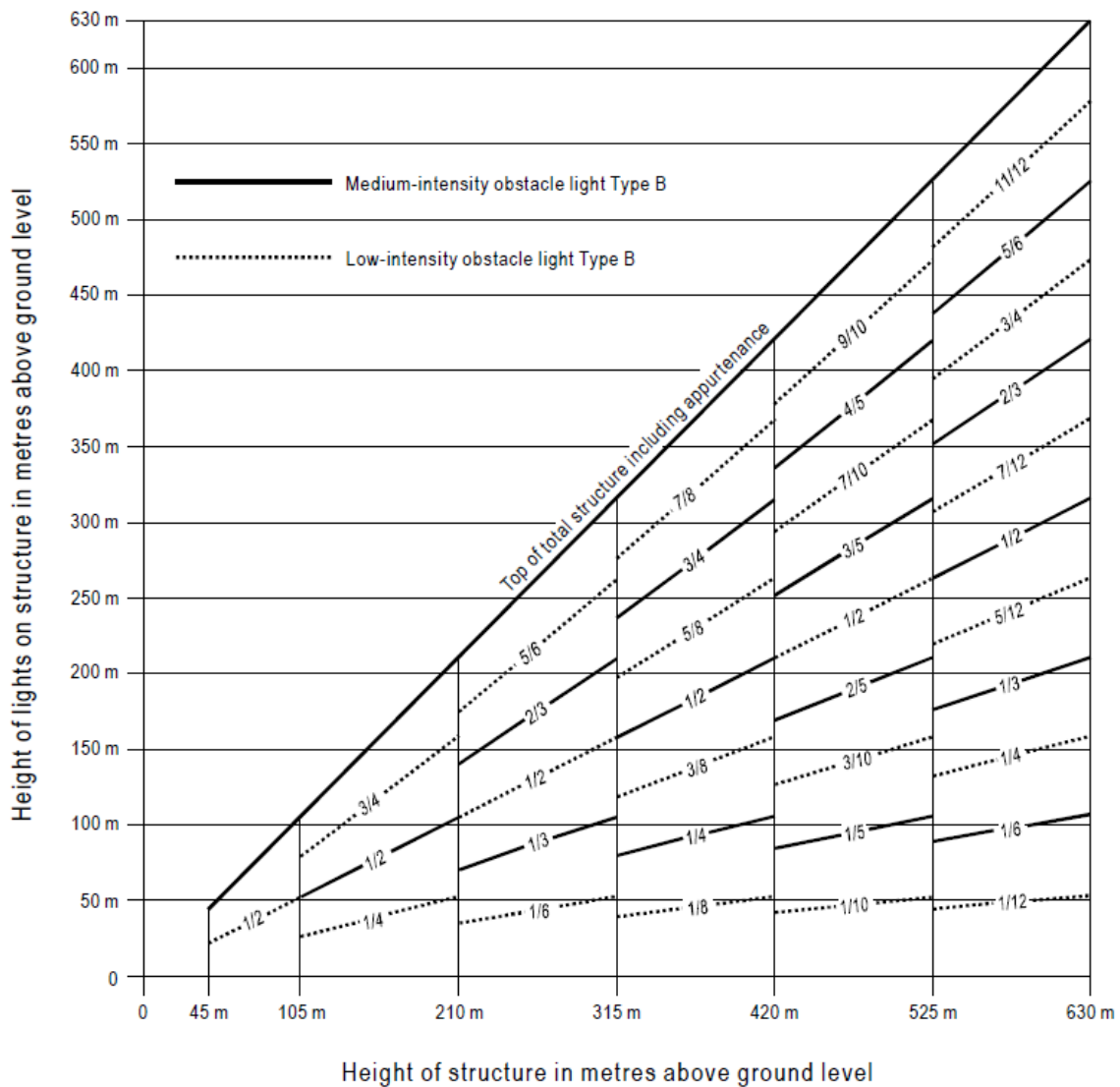
- (a) Guidance on how a combination of low-, medium-, and/or high-intensity lights on obstacles should be displayed is given in Figures GM-Q-1 to GM-Q-8.
- (b) High-intensity obstacle lights are intended for day use as well as night use. Care should be taken to ensure that these lights do not create disconcerting dazzle or environmental concerns. Guidance on the design, location, and operation of high-intensity obstacle lights is given in ICAO Doc 9157, Aerodrome Design Manual, Part 4, Visual Aids.
- (c) Where, the use of high-intensity obstacle lights, Type A, or medium-intensity obstacle lights, Type A, at night may dazzle pilots in the vicinity of an aerodrome (within approximately 10 000 m radius) or cause significant environmental concerns, a dual obstacle lighting system should be provided. This system should be composed of high-intensity obstacle lights, Type A, or medium intensity obstacle lights, Type A, as appropriate, for daytime and twilight use and medium-intensity obstacle light, Type B or C, for night-time use.



*Note.— High-intensity obstacle lighting is recommended on structures with a height of more than 150 m above ground level. If medium-intensity lighting is used, marking will also be required.*

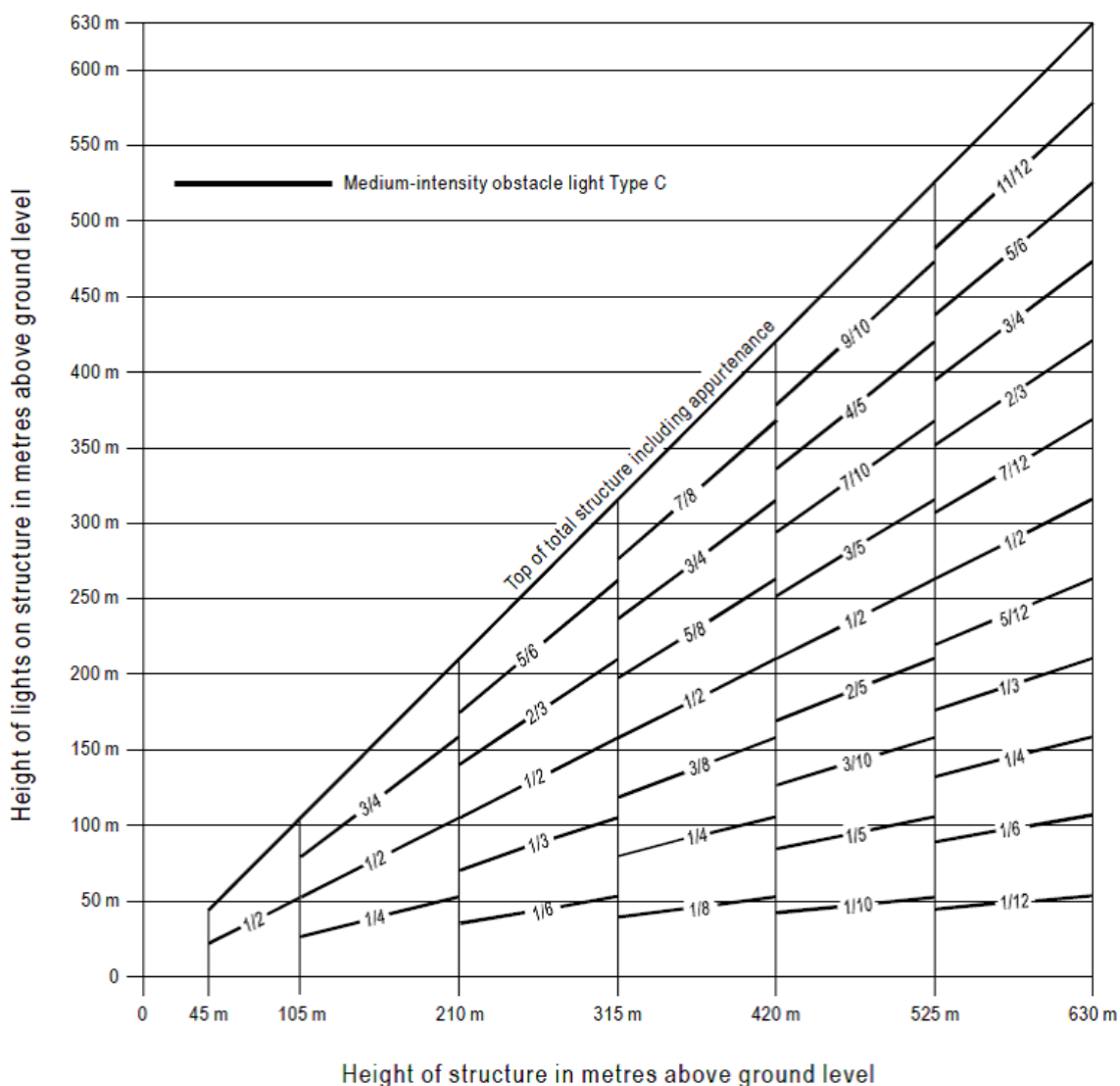
**Figure GM-Q-1. Medium-intensity flashing-white obstacle lighting system, Type A**





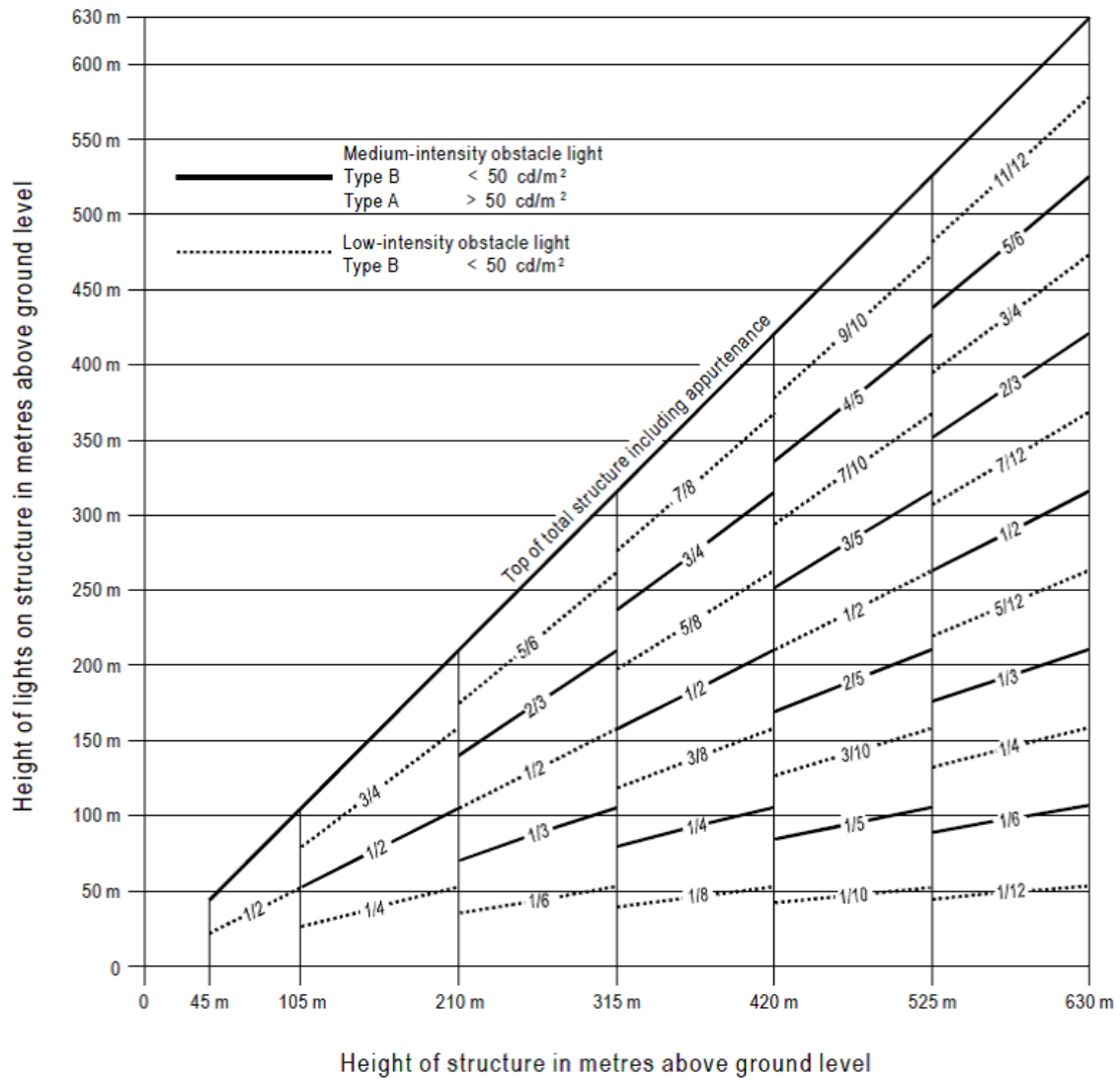
Note.— For night-time use only.

Figure GM-Q-2. Medium-intensity flashing-red obstacle lighting system, Type B



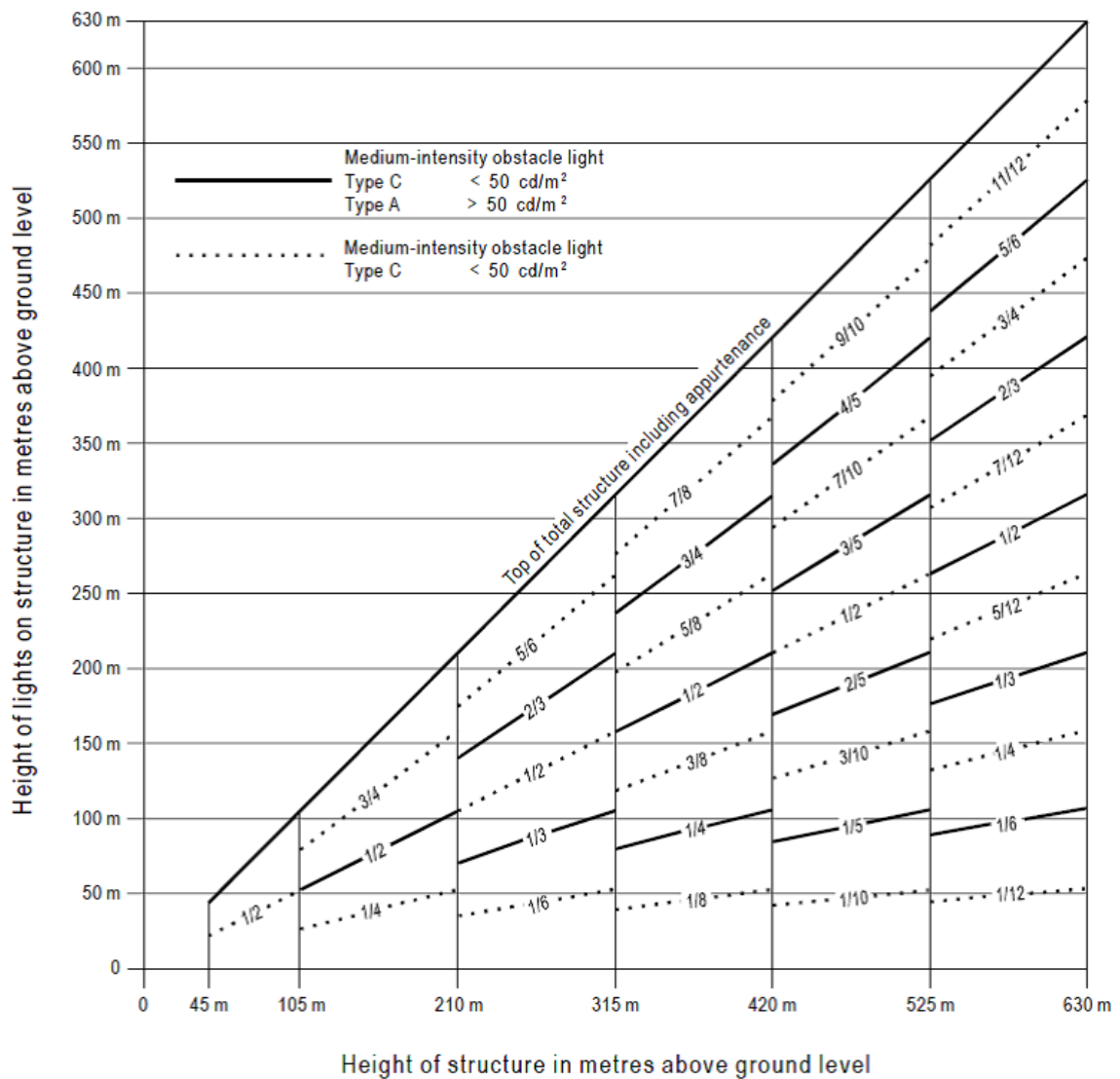
*Note.— For night-time use only.*

**Figure GM-Q-3. Medium-intensity fixed-red obstacle lighting system, Type C**



Note.— High-intensity obstacle lighting is recommended on structures with a height of more than 150 m above ground level. If medium-intensity lighting is used, marking will also be required.

Figure GM-Q-4. Medium-intensity dual obstacle lighting system, Type A/Type B



Note.— High-intensity obstacle lighting is recommended on structures with a height of more than 150 m above ground level. If medium-intensity lighting is used, marking will also be required.

Figure GM-Q-5. Medium-intensity dual obstacle lighting system, Type A/Type C

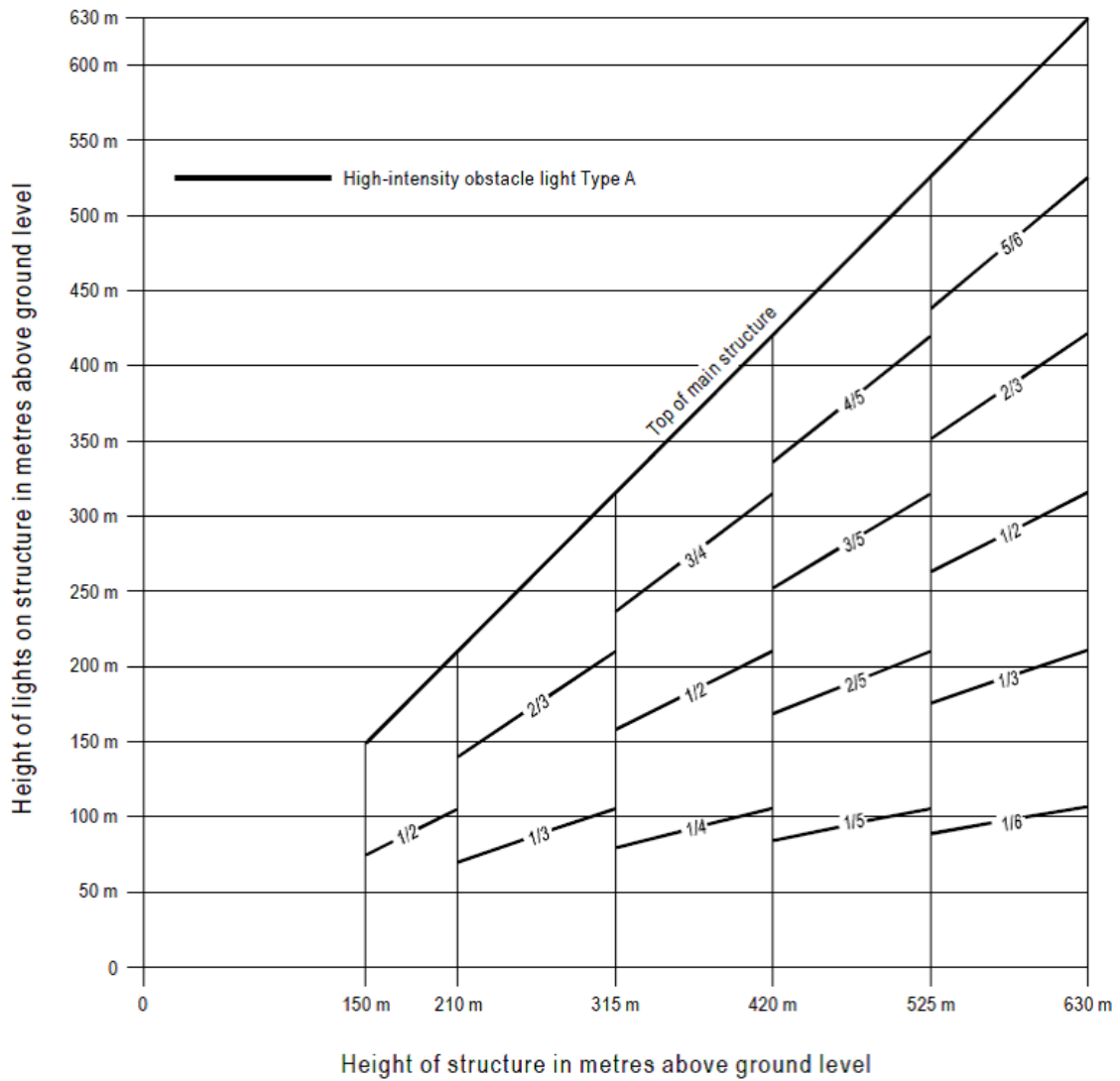


Figure GM-Q-6. High-intensity flashing-white obstacle lighting system, Type A

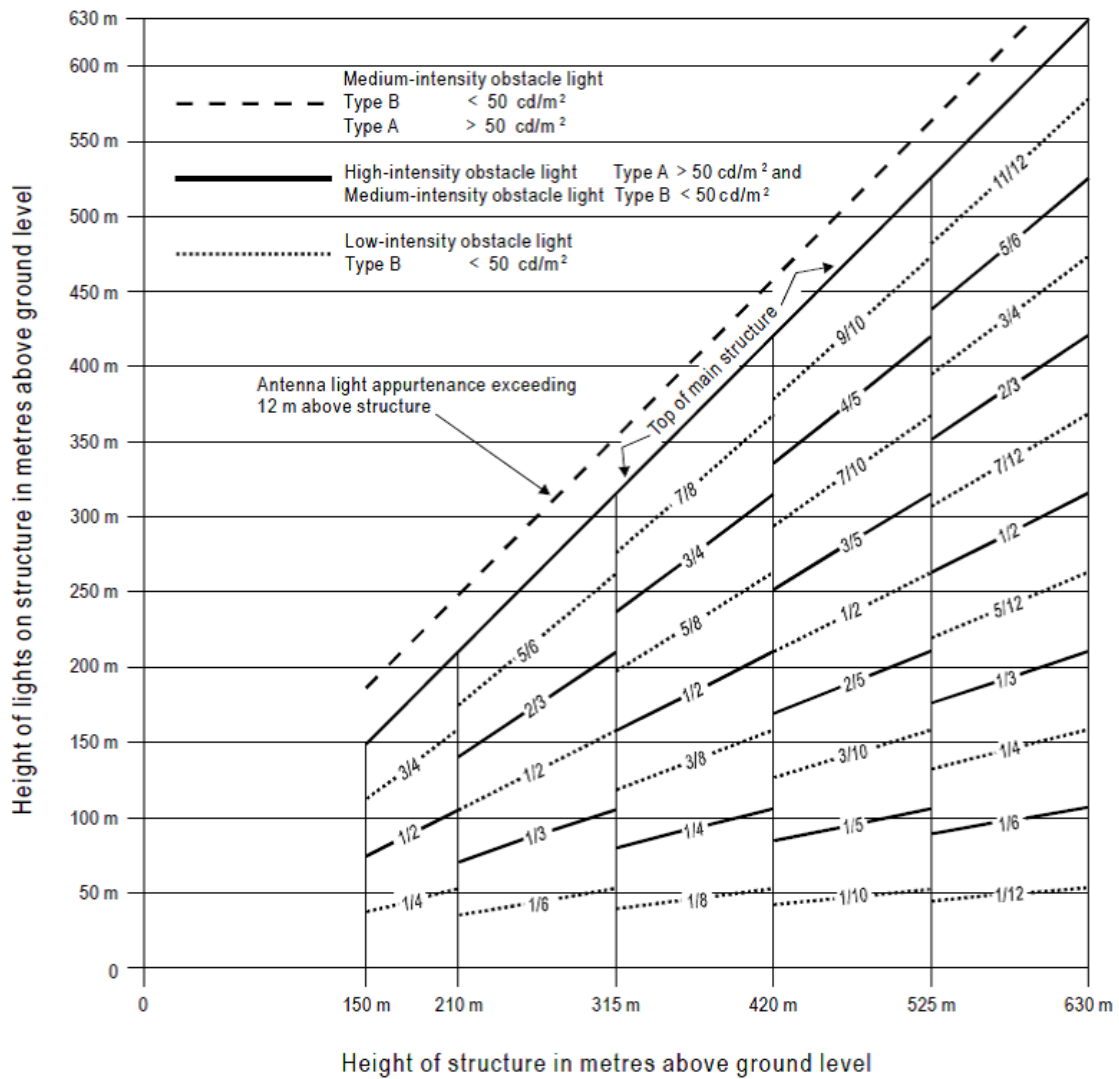
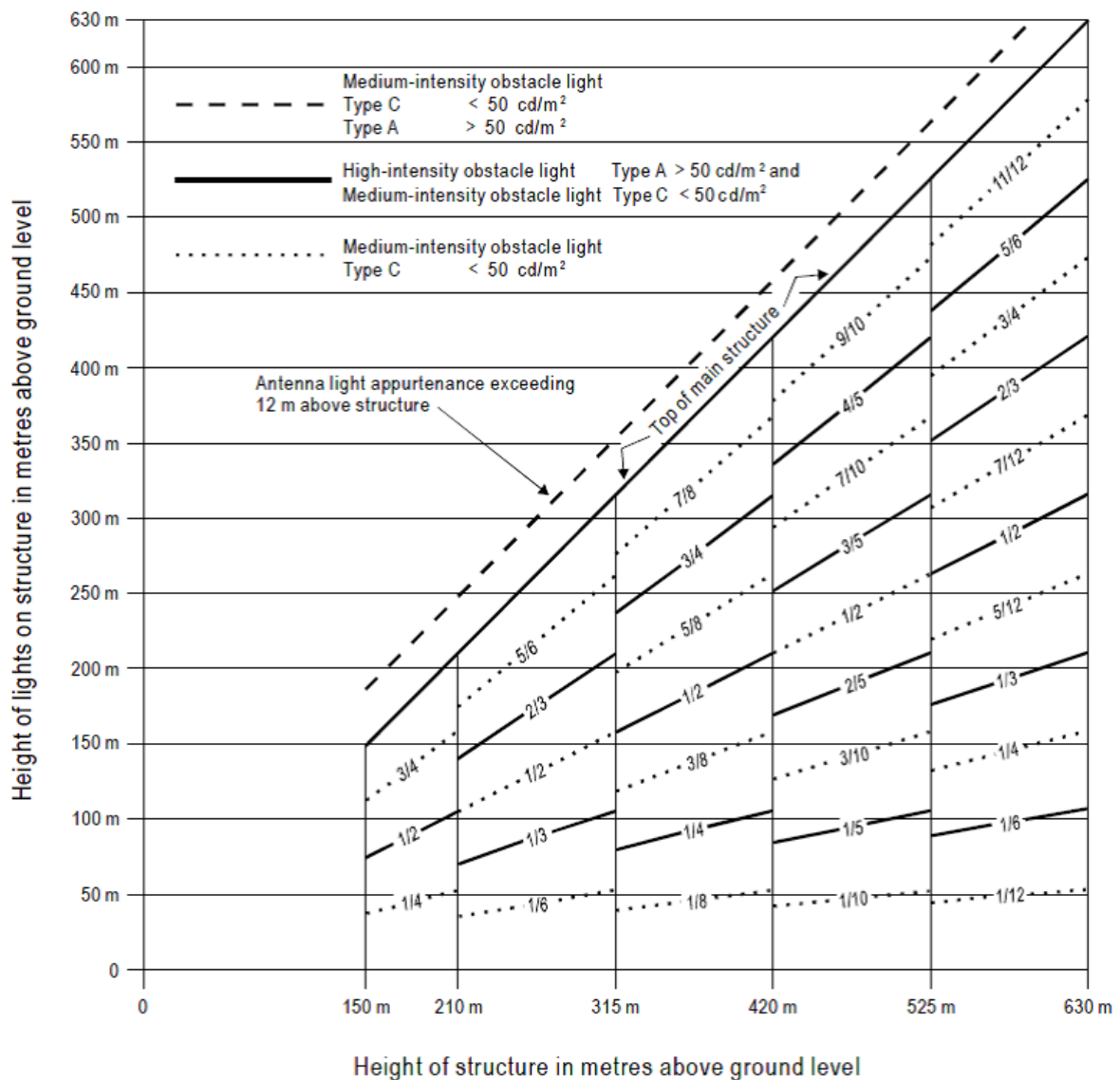


Figure GM-Q-7. High-/medium-intensity dual obstacle lighting system, Type A/Type B



**Figure GM-Q-8. High-/medium-intensity dual obstacle lighting system, Type A/Type C**

In the cases as stated in [CS ADR-DSN.Q.848\(c\) and \(d\)](#), normally the spacing would not exceed 52 m.

[Issue: ADR-DSN/3]

## CS ADR-DSN.Q.847 Lighting of fixed objects with a height less than 45 m above ground level

ED Decision 2016/027/R

- Low-intensity obstacle lights, Type A or B, should be used where the object is a less extensive one and its height above the surrounding ground is less than 45 m.
- Where the use of low-intensity obstacle lights, Type A or B, would be inadequate, or an early special warning is required, then medium- or high-intensity obstacle lights should be used.
- Low-intensity obstacle lights, Type B, should be used either alone or in combination with medium-intensity obstacle lights, Type B, in accordance with subparagraph (d), below.

- (d) Medium-intensity obstacle lights, Type A, B, or C, should be used where the object is an extensive one. Medium-intensity obstacle lights, Types A and C, should be used alone, whereas medium-intensity obstacle lights, Type B, should be used either alone or in combination with low-intensity obstacle lights, Type B.

[Issue: ADR-DSN/3]

## GM1 ADR-DSN.Q.847 Lighting of fixed objects with a height less than 45 m above ground level

*ED Decision 2016/027/R*

A group of buildings is regarded as an extensive object.

[Issue: ADR-DSN/3]

## CS ADR-DSN.Q.848 Lighting of fixed objects with a height 45 m to a height less than 150 m above ground level

*ED Decision 2016/027/R*

- (a) Medium-intensity obstacle lights, Type A, B, or C, should be used where the object is an extensive one. Medium-intensity obstacle lights, Types A and C, should be used alone, whereas medium-intensity obstacle lights, Type B, should be used either alone or in combination with low-intensity obstacle lights, Type B.
- (b) Where an object is indicated by medium-intensity obstacle lights, Type A, and the top of the object is more than 105 m above the level of the surrounding ground, or the elevation of tops of nearby buildings (when the object to be marked is surrounded by buildings), additional lights should be provided at intermediate levels. These additional intermediate lights should be spaced, as equally as practicable, between the top lights and ground level or the level of tops of nearby buildings as appropriate, with the spacing not exceeding 105 m.
- (c) Where an object is indicated by medium-intensity obstacle lights, Type B, and the top of the object is more than 45 m above the level of the surrounding ground or the elevation of tops of nearby buildings (when the object to be marked is surrounded by buildings), additional lights should be provided at intermediate levels. These additional intermediate lights should be alternately low-intensity obstacle lights, Type B, and medium-intensity obstacle lights, Type B, and should be spaced as equally as practicable, between the top lights and ground level or the level of tops of nearby buildings as appropriate, with the spacing not exceeding 52 m.
- (d) Where an object is indicated by medium-intensity obstacle lights, Type C, and the top of the object is more than 45 m above the level of the surrounding ground or the elevation of tops of nearby buildings (when the object to be marked is surrounded by buildings), additional lights should be provided at intermediate levels. These additional intermediate lights should be spaced as equally as practicable, between the top lights and ground level or the level of tops of nearby buildings, as appropriate, with the spacing not exceeding 52 m.
- (e) Where high-intensity obstacle lights, Type A, are used, they should be spaced at uniform intervals not exceeding 105 m between the ground level and the top light(s) specified in paragraph [CS ADR-DSN.Q.846\(d\)](#), except that where an object to be marked is surrounded by buildings, the elevation of the tops of the buildings may be used as the equivalent of the ground level when determining the number of light levels.

[Issue: ADR-DSN/3]



## GM1 ADR-DSN.Q.848 Lighting of fixed objects with a height 45 m to a height less than 150 m above ground level

ED Decision 2016/027/R

Low-intensity obstacle lights, Type A or B, may be used for obstacles higher than 45 m if it is determined to be sufficient.

[Issue: ADR-DSN/3]

## CS ADR-DSN.Q.849 Lighting of fixed objects with a height 150 m or more above ground level

ED Decision 2016/027/R

- (a) High-intensity obstacle lights, Type A, should be used to indicate the presence of an object if its height above the level of the surrounding ground exceeds 150 m and a safety assessment indicates such lights to be essential for the recognition of the object by day.
- (b) Where high-intensity obstacle lights, Type A, are used, they should be spaced at uniform intervals not exceeding 105 m between the ground level and the top light(s) specified in [CS ADR-DSN.Q.846\(d\)](#), except where an object to be marked is surrounded by buildings, the elevation of the tops of the buildings may be used as the equivalent of the ground level when determining the number of light levels.
- (c) Where an object is indicated by medium-intensity obstacle lights, Type A, additional lights should be provided at intermediate levels. These additional intermediate lights should be spaced, as equally as practicable, between the top lights and ground level or the level of tops of nearby buildings, as appropriate, with the spacing not exceeding 105 m.
- (d) Where an object is indicated by medium-intensity obstacle lights, Type B, additional lights should be provided at intermediate levels. These additional intermediate lights should be alternately low-intensity obstacle lights, Type B, and medium-intensity obstacle lights, Type B, and should be spaced, as equally as practicable, between the top lights and ground level or the level of tops of nearby buildings, as appropriate, with the spacing not exceeding 52 m.
- (e) Where an object is indicated by medium-intensity obstacle lights, Type C, additional lights should be provided at intermediate levels. These additional intermediate lights should be spaced, as equally as practicable, between the top lights and ground level or the level of tops of nearby buildings, as appropriate, with the spacing not exceeding 52 m.

[Issue: ADR-DSN/3]

## GM1 ADR-DSN.Q.849 Lighting of fixed objects with a height 150 m or more above ground level

ED Decision 2016/027/R

Where, the use of high-intensity obstacle lights, Type A, at night may dazzle pilots in the vicinity of an aerodrome (within approximately 10 000 m radius) or cause significant environmental concerns, medium-intensity obstacle lights, Type C, should be used alone, whereas medium-intensity obstacle lights, Type B, should be used either alone or in combination with low-intensity obstacle lights, Type B.

[Issue: ADR-DSN/3]

## CS ADR-DSN.Q.850

ED Decision 2021/004/R

*Intentionally left blank*

[Issue: ADR-DSN/3]

[Issue: ADR-DSN/5]

## GM1 ADR-DSN.Q.850

ED Decision 2021/004/R

*Intentionally left blank*

[Issue: ADR-DSN/3]

[Issue: ADR-DSN/5]

## CS ADR-DSN.Q.851 Marking and lighting of wind turbines

ED Decision 2016/027/R

- (a) Applicability: When considered as an obstacle a wind turbine should be marked and/or lighted.
- (b) Marking: The rotor blades, nacelle and upper 2/3 of the supporting mast of wind turbines should be painted white, or if after a safety assessment, it is determined that other colour will improve safety.
- (c) Lighting:
  - (1) Where lighting is deemed necessary for a single wind turbine or short line of wind turbines, the installation should be in accordance with paragraph (c)(2)(v) below, or as determined by a safety assessment.
  - (2) When lighting is deemed necessary in the case of a wind farm (i.e. a group of two or more wind turbines), the wind farm should be regarded as an extensive object and lights should be installed:
    - (i) to identify the perimeter of the wind farm;
    - (ii) respecting the maximum spacing, in accordance with [CS ADR-DSN.Q.846\(i\)](#), between the lights along the perimeter, or if after a safety assessment, it is determined that a greater spacing can be used;
    - (iii) so that, where flashing lights are used, they flash simultaneously throughout the wind farm;
    - (iv) so that, within a wind farm, any wind turbines of significantly higher elevation are also identified wherever they are located; and
    - (v) at locations prescribed in (i), (ii) and (iv):
      - (A) for wind turbines of less than 150 m in overall height (hub height plus vertical blade height), medium intensity lighting on the nacelle;
      - (B) for wind turbines from 150 m to 315 m in overall height, in addition to the medium intensity light installed on the nacelle, a second light serving as an alternate should be provided in case of failure of the operating light; the lights should be installed to assure that the output of either light is not blocked by the other;

- (C) in addition, for wind turbines from 150 m to 315 m in overall height, an intermediate level at half the nacelle height of at least three low intensity Type E lights, as specified in [CS ADR-DSN.Q.846\(c\)](#), that are configured to flash at the same rate as the light on the nacelle; low-intensity Type A or B lights may be used if an safety assessment shows that low intensity Type E lights are not suitable.
- (3) The obstacle lights should be installed on the nacelle in such a manner as to provide an unobstructed view for aircraft approaching from any direction.

[Issue: ADR-DSN/3]

## GM1 ADR-DSN.Q.851 Marking and lighting of wind turbines

*ED Decision 2016/027/R*

- (a) Additional markings and lighting may be provided to the wind turbines if indicated by a safety assessment.
- (b) Case by case studies for wind turbines of more than 315 m of overall height may conclude that additional markings and lighting are required.

[Issue: ADR-DSN/3]

## CS ADR-DSN.Q.852 Marking and lighting of overhead wires, cables, supporting towers, etc.

*ED Decision 2017/021/R*

- (a) Marking: The wires, cables, etc. to be marked should be equipped with markers; the supporting tower should be coloured.
- (b) Marking by colours: The supporting towers of overhead wires, cables, etc. that require marking should be marked in accordance with [CS ADR-DSN.Q.845\(b\)](#), except that the marking of the supporting towers may be omitted when they are lighted by high-intensity obstacle lights by day.
- (c) Marking by markers:
  - (1) Markers displayed on or adjacent to objects should be located in conspicuous positions so as to retain the general definition of the object and should be recognisable in clear weather from a distance of at least 1 000 m for an object to be viewed from the air and 300 m for an object to be viewed from the ground in all directions in which an aircraft is likely to approach the object. The shape of markers should be distinctive to the extent necessary to ensure that they are not mistaken for markers employed to convey other information, and they should be such that the hazard presented by the object they mark is not increased.
  - (2) A marker displayed on an overhead wire, cable, etc., should be spherical and have a diameter of not less than 60 cm.
  - (3) The spacing between two consecutive markers, or between a marker and a supporting tower, should be appropriate to the diameter of the marker. The spacing should normally not exceed:
    - (i) 30 m where the marker diameter is 60 cm, increasing progressively with increase of the marker diameter to:

- (ii) 35 m where the marker diameter is 80 cm; and
- (iii) further progressive increases to a maximum of 40 m where the marker diameter is of at least 130 cm.

Where multiple wires, cables, etc., are involved, a marker should be located not lower than the level of the highest wire at the point marked.

- (4) A marker should be of one colour. When installed, white and red, or white and orange, markers should be displayed alternately. The colour selected should contrast with the background against which it should be seen.
  - (5) When it has been determined that an overhead wire, cable, etc., needs to be marked but it is not practicable to install markers on the wire, cable, etc., then high-intensity obstacle lights, Type B, should be provided on their supporting towers.
- (d) Lighting:
- (1) High-intensity obstacle lights, Type B, should be used to indicate the presence of the tower supporting overhead wires, cables, etc. where:
    - (i) a safety assessment indicates such light to be essential for the recognition of the presence of wires, cables, etc.; or
    - (ii) it has not been found practicable to install marker on the wires, cables, etc.
  - (2) Where high-intensity obstacle lights, Type B, are used, they should be located at three levels:
    - (i) at the top of the tower;
    - (ii) at the lowest level of the catenary of the wires or cables; and
    - (iii) at approximately midway between these two levels.
  - (3) High-intensity obstacle lights, Type B, indicating the presence of a tower supporting overhead wires, cables, etc., should flash sequentially; first the middle light, second the top light, and last the bottom light. The intervals between flashes of the lights should approximate the following ratios:
 

Flash interval between	Ratio of cycle time
Middle and top light	1/13
Top and bottom light	2/13
Bottom and middle light	10/13
  - (4) The installation setting angles for high-intensity obstacle lights, Types B, should be in accordance with Table Q-5.

(1)	(2)	(3)	(4)	(5)	(6)	(7)
Light type	Colour	Signal type/ (Flash Rate)	Peak intensity (cd) at given Background Luminance (b)			Light Distribution Table
			Day (Above 500 cd/m <sup>2</sup> )	Twilight (50-500 cd/m <sup>2</sup> )	Night (Below 50 cd/m <sup>2</sup> )	
Low-intensity Type A (fixed obstacle)	Red	Fixed	N/A	N/A	10	Table Q-2
Low-intensity Type B (fixed obstacle)	Red	Fixed	N/A	N/A	32	Table Q-2
Low-intensity Type C (mobile obstacle)	Yellow/ Blue (a)	Flashing (60-90 fpm)	N/A	40	40	Table Q-2
Low-intensity Type D (follow-me vehicle)	Yellow	Flashing (60-90 fpm)	N/A	200	200	Table Q-2
Low-intensity, Type E	Red	Flashing (c)	N/A	N/A	32	Table Q-2 (Type B)
Medium-intensity Type A	White	Flashing (20-60 fpm)	20 000	20 000	2 000	Table Q-3
Medium-intensity Type B	Red	Flashing (20-60 fpm)	N/A	N/A	2 000	Table Q-3
Medium-intensity Type C	Red	Fixed	N/A	N/A	2 000	Table Q-3
High-intensity Type A	White	Flashing (40-60 fpm)	200 000	20 000	2 000	Table Q-3
High-intensity Type B	White	Flashing (40-60 fpm)	100 000	20 000	2 000	Table Q-3

(a) [CS ADR-DSN.Q.850\(b\)](#)

(b) For flashing lights, effective intensity as determined in accordance with ICAO Doc 9157, Aerodrome Design Manual, Part 4, Visual Aids.

(c) For wind turbine application, to flash at the same rate as the lighting on the nacelle.

**Table Q-1. Characteristics of obstacle lights**

	Minimum intensity (a)	Maximum intensity (a)	Vertical beam spread (f)	
			Minimum beam spread	Intensity
Type A	10 cd (b)	N/A	10°	5 cd
Type B	32 cd (b)	N/A	10°	16 cd
Type C	40 cd (b)	400 cd	12(d)	20 cd
Type D	200 cd (c)	400 cd	N/A(e)	N/A

Note: This table does not include recommended horizontal beam spreads. [CS ADR-DSN.Q.846\(c\)](#) requires 360° coverage around an obstacle. Therefore, the number of lights needed to meet this requirement will depend on the horizontal beam spreads of each light as well as the shape of the obstacle. Thus, with narrower beam spreads, more lights will be required.

- (a) 360° horizontal. For flashing lights, the intensity is read into effective intensity, as determined in accordance with ICAO, Aerodrome Design Manual, Part 4, Visual Aids.
- (b) Between 2 and 10° vertical. Elevation vertical angles are referenced to the horizontal when the light is levelled.
- (c) Between 2 and 20° vertical. Elevation vertical angles are referenced to the horizontal when the light is levelled.
- (d) Peak intensity should be located at approximately 2.5° vertical.
- (e) Peak intensity should be located at approximately 17° vertical.
- (f) Beam spread is defined as the angle between the horizontal plan and the directions for which the intensity exceeds that mentioned in the 'intensity' column.

**Table Q-2. Light distribution for low-intensity obstacle lights**

Benchmark intensity	Minimum requirements					Recommendations				
	Vertical elevation angle (b)			Vertical beam spread (c)		Vertical elevation angle (b)			Vertical beam spread (c)	
	0°		-1°			0°	-1°	-10°		
	Minimum average intensity (a)	Minimum intensity (a)	Minimum intensity (a)	Minimum beam spread	Intensity (a)	Maximum intensity (a)	Maximum intensity (a)	Maximum intensity (a)	Maximum beam spread	Intensity (a)
200 000	200 000	150 000	75 000	3°	75 000	250 000	112 500	7 500	7°	75 000
100 000	100 000	75 000	37 500	3°	37 500	125 000	56 250	3 750	7°	37 500
20 000	20 000	15 000	7 500	3°	7 500	25 000	11 250	750	N/A	N/A
2 000	2 000	1 500	750	3°	750	2 500	1 125	75	N/A	N/A

Note: This table does not include recommended horizontal beam spreads. [CS ADR-DSN.Q.846\(c\)](#) requires 360° coverage around an obstacle. Therefore, the number of lights needed to meet this requirement will depend on the horizontal beam spreads of each light as well as the shape of the obstacle. Thus, with narrower beam spreads, more lights will be required.

- (a) 360° horizontal. All intensities are expressed in Candela. For flashing lights, the intensity is read into effective intensity, as determined in accordance with ICAO Doc 9157, Aerodrome Design Manual, Part 4, Visual Aids.
- (b) Elevation vertical angles are referenced to the horizontal when the light unit is levelled.
- (c) Beam spread is defined as the angle between the horizontal plan and the directions for which the intensity exceeds that mentioned in the 'intensity' column.

Note: an extended beam spread may be necessary under specific configuration and justified by an aeronautical study.

**Table Q-3. Light distribution for medium- and high-intensity obstacle lights according to benchmark intensities of Table Q-1**

Longest dimension		Band width
Greater than	Not exceeding	
1.5 m	210 m	1/7 of longest dimension
210 m	270 m	1/9 "" "
270 m	330 m	1/11 "" "
330 m	390 m	1/13 "" "
390 m	450 m	1/15 "" "
450 m	510 m	1/17 "" "
510 m	570 m	1/19 "" "
570 m	630 m	1/21 "" "

Table Q-4. Marking band widths

Height of light unit above terrain (AGL)		Angle of the peak of the beam above the horizontal
Greater than	Not exceeding	
151 m		0°
122 m	151 m	1°
92 m	122 m	2°
	92 m	3°

Table Q-5. Installation setting angles for high-intensity obstacle lights

[Issue: ADR-DSN/3]

[Issue: ADR-DSN/4]



## GM1 ADR-DSN.Q.852 Marking and lighting of overhead wires, cables, supporting towers, etc.

ED Decision 2016/027/R

- (a) Where high-intensity obstacle lights, Type B, are used, and it is not possible to locate them as described in [CS ADR-DSN.Q.852\(d\)\(2\)](#), in some cases, this may require locating the lights off the tower.
- (b) High-intensity obstacle lights are intended for day use as well as night use. Care should be taken to ensure that these lights do not create disconcerting dazzle or environmental concerns. Guidance on the design, location, and operation of high-intensity obstacle lights is given in ICAO Doc 9157, Aerodrome Design Manual, Part 4, Visual Aids.
- (c) Where the use of high-intensity obstacle lights, Type B, at night may dazzle pilots in the vicinity of an aerodrome (within approximately 10 000 m radius) or cause significant environmental concerns, a dual obstacle lighting system should be provided. This system should be composed of high-intensity obstacle lights, Type B, for daytime and twilight use and medium-intensity obstacle lights, Type B, for night-time use. Where medium-intensity lights are used they should be installed at the same level as the high-intensity obstacle light Type B.

[Issue: ADR-DSN/3]

## CHAPTER R — VISUAL AIDS FOR DENOTING RESTRICTED USE AREAS

### CS ADR-DSN.R.855 Closed runways and taxiways, or parts thereof

ED Decision 2021/004/R

- (a) Applicability:  
A closed marking should be displayed on a runway, or taxiway, or portion thereof which is permanently closed to the use of all aircraft.
- (b) Location of closed markings: On a runway, a closed marking should be placed at each end of the runway, or portion thereof, declared closed, and additional markings should be so placed that the maximum interval between markings does not exceed 300 m. On a taxiway a closed marking should be placed at least at each end of the taxiway or portion thereof closed.
- (c) Characteristics of closed markings: The closed marking should be of the form and proportions as detailed in Figure R-1, Illustration (a), when displayed on a runway, and should be of the form and proportions as detailed in Figure R-1, Illustration (b), when displayed on a taxiway. The marking should be white when displayed on a runway and should be yellow when displayed on a taxiway.
- (d) When a runway, or taxiway, or portion thereof is permanently closed, all normal runway and taxiway markings should be physically removed.
- (e) In addition to closed markings, when the runway, or taxiway, or portion thereof closed is intercepted by a usable runway or taxiway which is used at night, unserviceability lights should be placed across the entrance to the closed area at intervals not exceeding 3 m (see [CS ADR-DSN.R.870\(c\)\(2\)](#)).

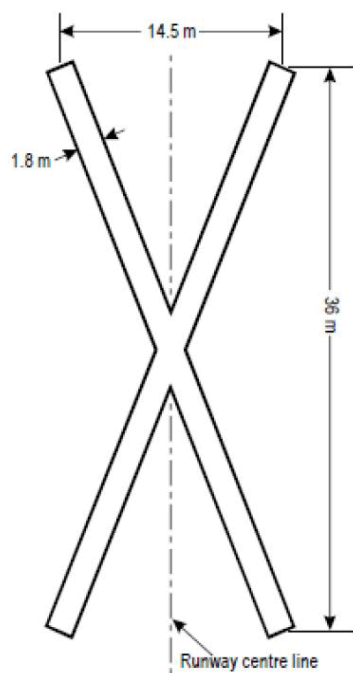


Illustration a) Closed runway marking

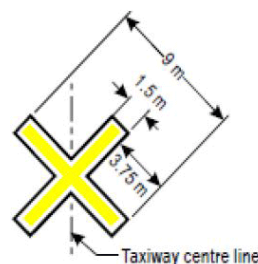


Illustration b) Closed taxiway marking

**Figure R-1. Runway and taxiway closed markings**

[Issue: ADR-DSN/3]

[Issue: ADR-DSN/5]

## GM1 ADR-DSN.R.855 Closed runways and taxiways, or parts thereof

ED Decision 2021/004/R

Information regarding the physical removal of runway and taxiway markings is contained in [AMC1 ADR.OPS.C.015\(d\)](#) and [GM1 ADR.OPS.C.015\(d\)](#).

[Issue: ADR-DSN/5]

## CS ADR-DSN.R.860 Non-load-bearing surfaces

ED Decision 2016/027/R

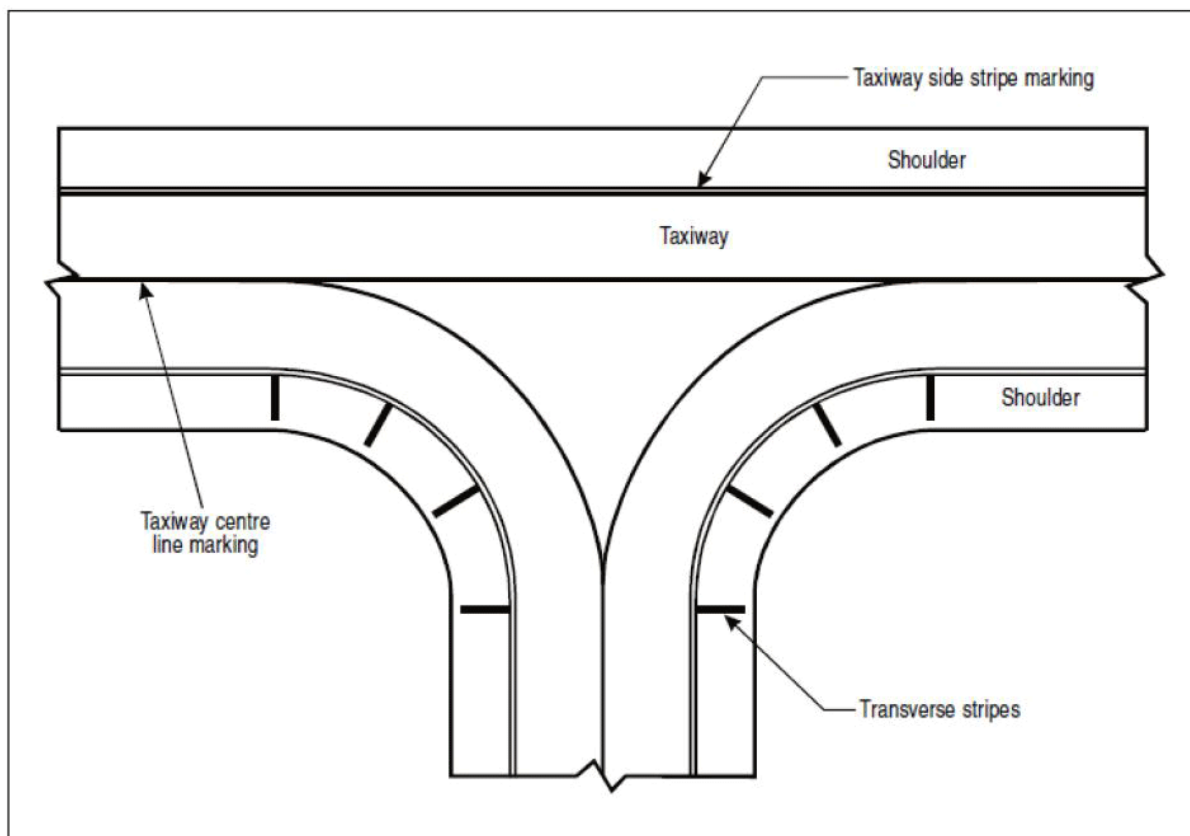
- (a) Shoulders for taxiways, runway turn pads, holding bays and aprons, and other non-load-bearing surfaces which cannot readily be distinguished from load-bearing surfaces and which, if used by aircraft, might result in damage to the aircraft, should have the boundary between such areas and the load-bearing surface marked by a taxi side stripe marking.
- (b) A taxi side stripe marking should consist of a pair of solid lines, each 15 cm wide and spaced 15 cm apart, and the same colour as the taxiway centre line marking.

[Issue: ADR-DSN/3]

## GM1 ADR-DSN.R.860 Non-load-bearing surfaces

ED Decision 2016/027/R

- (a) A taxi side stripe marking could also be placed along the edge of the load-bearing pavement to emphasise the location of the taxiway edge, with the outer edge of the marking approximately on the edge of the load-bearing pavement.
- (b) At intersections of taxiways and on other areas where, due to turning, the possibility for confusion between the side stripe markings and centre line markings may exist, or where the pilot may not be sure on which side of the edge marking the non-load bearing pavement is, the additional provision of transverse stripes on the non-load bearing surface has been found to be of assistance.
- (c) As shown in Figure GM-R-1, the transverse stripes should be placed perpendicular to the side stripe marking.
- (d) On curves, a stripe should be placed at each point of tangency of the curve and at intermediate points along the curve so that the interval between stripes does not exceed 15 m. If deemed desirable to place transverse stripes on small straight sections, the spacing should not exceed 30 m.
- (e) The width of the marks should be 0.9 m, and they should extend to within 1.5 m of the outside edge of the stabilised paving or be 7.5 m long whichever is shorter. The colour of the transverse stripes should be the same as that of the edge stripes, i.e. yellow.



**Figure GM-R-1. Marking of non-load bearing paved taxiway surface**

More guidance on providing additional transverse stripes at an intersection or a small area on the apron is given in ICAO Doc 9157, Aerodrome Design Manual, Part 4, Visual Aids.

[Issue: ADR-DSN/3]

## CS ADR-DSN.R.865 Pre-threshold area

*ED Decision 2014/013/R*

- (a) Applicability of Pre-threshold area: When the surface before a threshold is paved and exceeds 60 m in length, and is not suitable for normal use by aircraft, the entire length before the threshold should be marked with a chevron marking.
- (b) Location: A chevron marking should point in the direction of the runway and be placed as shown in Figure R-2.
- (c) Characteristics: A chevron marking should be of conspicuous colour and contrast with the colour used for the runway markings; it should preferably be yellow and should have an overall width of at least 0.9 m.

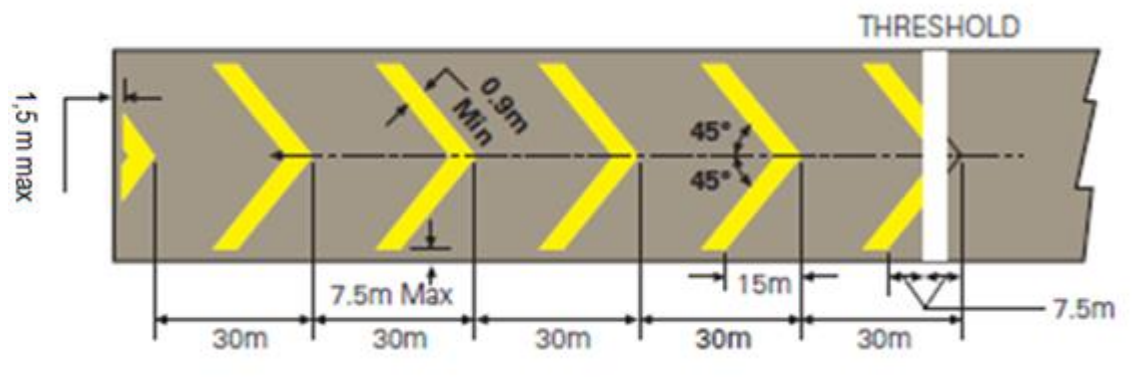


Figure R-2. Pre-threshold area marking

## GM1 ADR-DSN.R.865 Pre-threshold area

ED Decision 2014/013/R

For pre-threshold areas shorter than 60 m, markings may be modified or reduced in size so as to present the correct picture to aircrew.

## CS ADR-DSN.R.870 Unserviceable areas

ED Decision 2014/013/R

(a) Applicability of unserviceability markers and lights:

Unserviceability markers should be displayed wherever any portion of a taxiway, apron, or holding bay is declared unfit for the movement of aircraft but it is still possible for aircraft to bypass the area safely. On a movement area used at night, unserviceability lights should be used.

(b) Location: Unserviceability markers and lights should be placed at intervals sufficiently close so as to delineate the unserviceable area.

(c) Characteristics:

- (1) Unserviceability markers should consist of conspicuous upstanding devices such as flags, cones, or marker boards.
- (2) An unserviceability light should consist of a red fixed light. The light should have intensity sufficient to ensure conspicuity considering the intensity of the adjacent lights and the general level of illumination against which it would normally be viewed. In no case should the intensity be less than 10 cd of red light.
- (3) An unserviceability cone should be at least 0.5 m in height and red, orange, or yellow, or any one of these colours in combination with white.
- (4) An unserviceability flag should be at least 0.5 m square and red, orange, or yellow, or any one of these colours in combination with white.
- (5) An unserviceability marker board should be at least 0.5 m in height and 0.9 m in length, with alternate red and white, or orange and white vertical stripes.

## GM1 ADR-DSN.R.870 Unserviceable areas

*ED Decision 2014/013/R*

- (a) Unserviceability markers and lights are used for such purposes as warning pilots of a hole in a taxiway, or apron pavement, or outlining a portion of pavement, such as on an apron, that is under repair. They are not suitable for use when a portion of a runway becomes unserviceable, nor on a taxiway when a major portion of the width becomes unserviceable. In such instances, the runway or taxiway is normally closed.
- (b) The spacing required for marking and lights should take into account visibility conditions, geometric configurations of the area, potential height differences of terrain so that the limits of unserviceable area is readily visible to pilot.
- (c) Where a temporarily unserviceable area exists, it may be marked with fixed-red lights. These lights mark the most potentially dangerous extremities of the area.
- (d) A minimum of four such lights may be used, except where the area is triangular in shape, in which case a minimum of three lights may be used.
- (e) The number of lights may be increased when the area is large or of unusual configuration. At least one light should be installed for each 7.5 m of peripheral distance of the area.
- (f) If the lights are directional, they should be orientated so that as far as possible, their beams are aligned in the direction from which aircraft or vehicles should approach.
- (g) Where aircraft or vehicles should normally approach from several directions, consideration should be given to adding extra lights or using omnidirectional lights to show the area from these directions.
- (h) Unserviceable area lights should be frangible. Their height should be sufficiently low to preserve clearance for propellers and for engine pods of jet aircraft.

## CHAPTER 5 — ELECTRICAL SYSTEMS

### CS ADR-DSN.S.875 Electrical power supply systems for air navigation facilities

ED Decision 2014/013/R

- (a) Adequate primary power supply should be available at aerodromes for the safe functioning of air navigation facilities.
- (b) The design and provision of electrical power systems for aerodrome visual and radio navigation aids should be such that an equipment failure should not leave the pilot with inadequate visual and non-visual guidance, or misleading information.
- (c) Electric power supply connections to those facilities for which secondary power is required should be so arranged that the facilities are automatically connected to the secondary power supply on failure of the primary source of power.
- (d) The time interval between failure of the primary source of power and the complete restoration of the services required by [CS ADR-DSN.S.880\(d\)](#) should be as short as practicable, except that for visual aids associated with non-precision, precision approach, or take-off runways the requirements of Table S-1 for maximum switch-over times should apply.

### GM1 ADR-DSN.S.875 Electrical power supply systems for air navigation facilities

ED Decision 2016/027/R

- (a) The safety of operations at aerodromes depends on the quality of the supplied power. The total electrical power supply system may include connections to one or more external sources of electric power supply, one or more local generating facilities, and to a distribution network including transformers and switchgear. Many other aerodrome facilities supplied from the same system need to be taken into account while planning the electrical power system at aerodromes.
- (b) The design and installation of the electrical systems need to take into consideration factors that can lead to malfunction, such as electromagnetic disturbances, line losses, power quality, etc. Additional guidance is given in ICAO Doc 9157, Aerodrome Design Manual, Part 5, Electrical Systems.
- (c) Switch-over time is the time required for the actual intensity of a light measured in a given direction to fall from 50 % and recover to 50 % during a power supply changeover, when the light is being operated at intensities of 25 % or above.
- (d) As a good practice, a measurement of the photometric parameters may be used for the evaluation of the switch-over time.
  - (1) If the switch-over time is greater than 1 second, the following corrective actions may be used to decrease the switch-over time:
    - (i) use of enhanced constant current regulators (CCR); or
    - (ii) use of uninterruptible power supply (UPS).

- (2) If the photometric based switch-over time is below or equal 1 second, it is recommended to analyse the electrical system in order to find out an equivalent electrical switch-over time.
- (e) For periodic measurement of the switch-over time a measurement of the equivalent electrical switch-over time at the feeding point of an aeronautical ground lights (AGL) system may be established.

[Issue: ADR-DSN/3]

## CS ADR-DSN.S.880 Electrical power supply systems

*ED Decision 2021/004/R*

- (a) For a precision approach runway, a secondary power supply capable of meeting the requirements of Table S-1 for the appropriate category of precision approach runway should be provided. Electric power supply connections to those facilities for which secondary power is required should be so arranged that the facilities are automatically connected to the secondary power supply on failure of the primary source of power.
- (b) For a runway meant for take-off in runway visual range conditions less than a value of 800 m, a secondary power supply capable of meeting the relevant requirements of Table S-1 should be provided.
- (c) At an aerodrome where the primary runway is a non-precision approach runway, a secondary power supply capable of meeting the requirements of Table S-1 should be provided except that a secondary power supply for visual aids need not be provided for more than one non-precision approach runway.
- (d) The following aerodrome facilities should be provided with a secondary power supply capable of supplying power when there is a failure of the primary power supply:
  - (1) the signalling lamp and the minimum lighting necessary to enable air traffic services personnel to carry out their duties;
  - (2) obstacle lights which are essential to ensure the safe operation of aircraft;
  - (3) approach, runway and taxiway lighting as specified in [CS ADR-DSN.M.625](#) to [CS ADR-DSN.M.745](#);
  - (4) meteorological equipment;
  - (5) essential equipment and facilities for the parking position if provided, in accordance with [CS ADR-DSN.M.750\(a\)](#) and [CS ADR-DSN.M.755\(a\)](#); and
  - (6) illumination of apron areas over which passengers may walk.

Runway	Lighting aids requiring power	Maximum switch-over time
Non-instrument	Visual approach slope indicators <sup>a</sup> Runway edge <sup>b</sup> Runway threshold <sup>b</sup> Runway end <sup>b</sup> Obstacle <sup>a</sup> Stopway end Stopway edge	See <a href="#">CS ADR-DSN.S.875(d)</a> and <a href="#">CS ADR-DSN.S.880(d)</a>



Runway	Lighting aids requiring power	Maximum switch-over time
Non-precision approach	Approach lighting system	15 seconds
	Visual approach slope indicators <sup>a, d</sup>	15 seconds
	Runway edge <sup>d</sup>	15 seconds
	Runway threshold <sup>d</sup>	15 seconds
	Runway end <sup>d</sup>	15 seconds
	Obstacle <sup>a</sup>	15 seconds
	Stopway end	15 seconds
	Stopway edge	15 seconds
Precision approach Category I	Approach lighting system	15 seconds
	Runway edge <sup>d</sup>	15 seconds
	Visual approach slope indicators <sup>a, d</sup>	15 seconds
	Runway threshold <sup>d</sup>	15 seconds
	Runway end	15 seconds
	Essential taxiway <sup>a</sup>	15 seconds
	Obstacle <sup>a</sup>	15 seconds
	Stopway end	15 seconds
Stopway edge	15 seconds	
Precision approach Category II/III	Inner 300 m of the approach lighting system	1 second
	Other parts of the approach lighting system	15 seconds
	Obstacle <sup>a</sup>	15 seconds
	Runway edge	15 seconds
	Runway threshold	1 second
	Runway end	1 second
	Runway centre line	1 second
	Runway touchdown zone	1 second
	Runway guard lights	15 seconds
	All stop bars	1 second
	Essential taxiway	15 seconds
	Stopway end	1 second
	Stopway edge	15 seconds
Runway meant for take-off in runway visual range conditions less than a value of 800 m	Runway edge	15 seconds <sup>c</sup>
	Runway end	1 second
	Runway centre line	1 second
	All stop bars	1 second
	Essential taxiway <sup>a</sup>	15 seconds
	Obstacle <sup>a</sup>	15 seconds
	Stopway end	1 second
	Stopway edge	15 seconds
a.	Supplied with secondary power when their operation is essential to the safety of flight operation.	
b.	The use of emergency lighting should be in accordance with any procedures established.	
c.	One second where no runway centre line lights are provided.	
d.	One second where approaches are over hazardous or precipitous terrain.	

**Table S-1. Secondary power supply requirements (see [CS ADR-DSN.S.875\(d\)](#))**

[Issue: ADR-DSN/3]

[Issue: ADR-DSN/4]

[Issue: ADR-DSN/5]

## GM1 ADR-DSN.S.880 Electrical power supply

ED Decision 2016/027/R

- (a) At an aerodrome where the primary runway is a non-instrument runway, a secondary power supply capable of meeting the requirements of [CS ADR-DSN.S.875\(d\)](#) should be provided, except that a secondary power supply for visual aids need not be provided when an emergency lighting system is provided and capable of being deployed in 15 minutes.
- (b) Specifications for secondary power supply for radio navigation aids and ground elements of communications systems are given in ICAO Annex 10, Volume I, Aeronautical Telecommunications, Chapter 2.
- (c) Requirements for a secondary power supply should be met by either of the following:
  - (1) independent public power which is a source of power supplying the aerodrome service from a substation other than the normal substation through a transmission line following a route different from the normal power supply route and such that the possibility of a simultaneous failure of the normal and independent public power supplies is extremely remote; or
  - (2) standby power unit(s) which are engine generators, batteries, etc. from which electric power can be obtained.
- (d) Guidance on electrical systems is included in ICAO Doc 9157, Aerodrome Design Manual, Part 5, Electrical Systems.
- (e) The requirement for minimum lighting may be met by other than electrical means.

[Issue: ADR-DSN/3]

## CS ADR-DSN.S.885 System design

ED Decision 2014/013/R

- (a) For a runway meant for use in runway visual range conditions less than a value of 550 m, the electrical systems for the power supply, lighting, and control of the lighting systems included in Table S-1 should be so designed that an equipment failure should not leave the pilot with inadequate visual guidance or misleading information.
- (b) Where the secondary power supply of an aerodrome is provided by the use of duplicate feeders, such supplies should be physically and electrically separate so as to ensure the required level of availability and independence.
- (c) Where a runway forming part of a standard taxi-route is provided with runway lighting and taxiway lighting, the lighting systems should be interlocked to preclude the possibility of simultaneous operation of both forms of lighting.

## GM1 ADR-DSN.S.885 System design

ED Decision 2016/027/R

Guidance on means of providing this protection is given in ICAO Doc 9157, Aerodrome Design Manual, Part 5, Electrical Systems.

[Issue: ADR-DSN/3]

## CS ADR-DSN.S.890 Monitoring

ED Decision 2021/004/R

- (a) A system of monitoring should be employed to indicate the operational status of the lighting systems.
- (b) Where lighting systems are used for aircraft control purposes, such systems should be monitored automatically so as to provide an indication of any fault which may affect the control functions. This information should be automatically relayed to the air traffic service unit.
- (c) Where a change in the operational status of lights has occurred, an indication should be provided within two seconds for a stop bar at a runway-holding position and within five seconds for all other types of visual aids.
- (d) For a runway meant for use in runway visual range conditions less than a value of 550 m, the lighting systems detailed in Table S-1 should be monitored automatically so as to provide an indication when the serviceability level of any element falls below a minimum serviceability level specified in [ADR.OPS.C.015](#) (b)(1) to (b)(7). This information should be automatically relayed to the maintenance crew.
- (e) For a runway meant for use in runway visual range conditions less than a value of 550 m, the lighting systems detailed in Table S-1 should be monitored automatically to provide an indication when the serviceability level of any element falls below a minimum level, below which operations should not continue. This information should be automatically relayed to the air traffic services unit and displayed in a prominent position.

[Issue: ADR-DSN/3]

[Issue: ADR-DSN/5]

## GM1 ADR-DSN.S.890 Monitoring

ED Decision 2016/027/R

- (a) For a runway meant for use in runway visual range conditions less than a value of 550 m, the minimum serviceability level of any element of the lighting system detailed in Table S-1, below which operations should not continue, is set up by the competent authority.
- (b) Additional guidance on air traffic control interface and visual aids monitoring is given in ICAO Doc 9157, Aerodrome Design Manual, Part 5, Electrical Systems.

[Issue: ADR-DSN/3]

## CS ADR-DSN.S.895

ED Decision 2021/004/R

*Intentionally left blank*

[Issue: ADR-DSN/3]

[Issue: ADR-DSN/5]

## GM1 ADR-DSN.S.895

ED Decision 2021/004/R

*Intentionally left blank*

[Issue: ADR-DSN/3]

[Issue: ADR-DSN/5]

## CHAPTER T — AERODROME OPERATIONAL SERVICES, EQUIPMENT AND INSTALLATION

### CS ADR-DSN.T.900 Emergency access and service roads

ED Decision 2016/027/R

Emergency access roads and service roads should be equipped with a road-holding position, in accordance with [CS ADR-DSN.L.600](#), [CS ADR-DSN.M.770](#) and [CS ADR-DSN.N.800](#), as appropriate, at all intersections with runway and taxiways.

[Issue: ADR-DSN/3]

### GM1 ADR-DSN.T.900 Emergency access and service roads

ED Decision 2016/027/R

- (a) Service roads at air side are installed to support all apron processes. Furthermore, service roads can be used as aerodrome perimeter service roads, providing access to navigation aids, as temporary roads for construction vehicles, etc.
- (b) Some general considerations in the planning of roads are described as follows:
  - (1) Every effort should be made to plan service roads at air side so that they do not cross runways and taxiways.
  - (2) The planning of the aerodrome road layout should take into account the need to provide emergency access roads for use by rescue and firefighting vehicles to various areas on the aerodrome, and, in particular, to the approach areas. Service roads to navigation aids should be planned in such a manner as to present minimal interference to the function of the aids. If it is necessary for a service road to cross an approach area, the road should be located so that vehicles travelling on it are not obstacles to aircraft operations.
  - (3) The service roads at air side system should be designed to account for local security measures. Access points to the system should, thus, need to be restricted. Should ground vehicle movements affect surface movement of aircraft on runways and taxiways, it should be required that the ground vehicle movements be coordinated by the appropriate aerodrome control. Control is normally exercised by means of two-way radio communication although visual signals, such as signal lamps, are adequate when traffic at the aerodrome is light. Signs or signals may also be employed to aid control at intersections.
  - (4) At intersections with runways consideration should be given to providing runway guard lights or road-holding position lights as part of the aerodrome's runway incursion prevention programme. Runway guard lights should conform to the specifications provided in [CS ADR-DSN.M.745](#).
  - (5) Roads should be designed and constructed to prevent FOD transfer to the runway and taxiways.
  - (6) Roads within 90 m of a runway centre line generally should be surfaced to prevent surface erosion, and the transfer of debris to the runway and taxiways.
  - (7) To facilitate the control and maintenance of the fencing, a perimeter service road should be constructed inside the aerodrome fencing.

- (8) Perimeter service road is also used by security patrols.
  - (9) Where a fence is provided, the need for convenient access to outside areas should be taken into account. These access points should be of a suitable size to accommodate the passage of the largest RFFS vehicle in the aerodrome's fleet.
  - (10) When greater security is thought necessary, a cleared area should be provided on both sides of the fence or barrier to facilitate the work of patrols, and to make trespassing more difficult.
  - (11) Special measures should be required to prevent the access of an unauthorised person to runways or taxiways which overpass public roads.
- (c) Emergency access roads should be considered on an aerodrome so as to facilitate achieving minimum response times for RFF vehicles.
  - (d) Emergency access roads should be provided on an aerodrome where terrain conditions permit their construction, so as to facilitate achieving minimum response times. Particular attention should be given to the provision of ready access to approach areas up to 1 000 m from the threshold, or at least within the aerodrome boundary.
  - (e) Emergency access roads are not intended for use for the functions of aerodrome service roads. Therefore, it is possible to provide different access control which should be clearly visible for all service ground traffic. Road-holding position markings, lights, or runway guard lights are not necessary if the access to an emergency access road is ensured for RFF only.
  - (f) Aerodrome service roads may serve as emergency access roads when they are suitably located and constructed.
  - (g) Emergency access roads should be capable of supporting the heaviest vehicles which should use them, and be usable in all weather conditions. Roads within 90 m of a runway centre line should be surfaced to prevent surface erosion and the transfer of debris to the runway. Sufficient vertical clearance should be provided from overhead obstructions for the largest vehicles.
  - (h) When the surface of the road is indistinguishable from the surrounding area, or in areas where snow may obscure the location of the roads, edge markers should be placed at intervals of about 10 m.

[Issue: ADR-DSN/3]

## **CS ADR-DSN.T.905 Fire stations**

*ED Decision 2014/013/R*

- (a) All rescue and firefighting vehicles should normally be housed in a fire station. Satellite fire stations should be provided whenever the response time cannot be achieved from a single fire station.
- (b) The fire station should be located so that the access for rescue and firefighting vehicles into the runway area is direct and clear, requiring a minimum number of turns.
- (c) The fire station, and any satellite fire stations, should be located outside taxiway and runway strips, and not infringe obstacle limitation surfaces.

## GM1 ADR-DSN.T.905 Fire stations

*ED Decision 2014/013/R*

intentionally left blank

## CS ADR-DSN.T.910 Equipment frangibility requirements

*ED Decision 2014/013/R*

Equipment and structures should be so designed to meet the appropriate frangibility characteristics, when required.

## GM1 ADR-DSN.T.910 Equipment frangibility requirements

*ED Decision 2016/027/R*

- (a) Equipment and supports required to be frangible should be designed and constructed so that they should break, distort, or yield in the event that they are accidentally impacted by an aircraft. The design materials selected should preclude any tendency for the components, including the electrical conductors, etc., to ‘wrap around’ the colliding aircraft or any part of it.
- (b) Frangible structures should be designed to withstand the static and operational wind or jet blast loads with a suitable factor of safety but should break, distort, or yield readily when subjected to the sudden collision forces of a 3 000 kg aircraft airborne and travelling at 140 km/h (75 kt), or moving on the ground at 50 km/h (27 kt).
- (c) Guidance on design for frangibility is contained in ICAO Doc 9157, Aerodrome Design Manual, Part 6, Frangibility.

[Issue: ADR-DSN/3]

## CS ADR-DSN.T.915 Siting of equipment and installations on operational areas

*ED Decision 2016/027/R*

- (a) Equipment and installations should be sited as far away from the runway and taxiway centre lines as practicable.
- (b) Unless its function requires it to be there for air navigation or for aircraft safety purposes, no equipment or installation endangering an aircraft should be located:
  - (1) on a runway strip, a runway end safety area, a taxiway strip, or within the following distances:

Code Letter	Distance between taxiway, other than aircraft stand taxilane, centre line to object (metres)
A	15.5
B	20
C	26
D	37
E	43.5
F	51

if it would endanger an aircraft, or

- (2) on a clearway if it would endanger an aircraft in the air.
- (c) Any equipment or installation required for air navigation or for aircraft safety purposes which should be located:
- (1) on that portion of a runway strip within:
- (i) 75 m of the runway centre line where the code number is 3 or 4; or
- (ii) 45 m of the runway centre line where the code number is 1 or 2; or
- (2) on a runway end safety area, a taxiway strip, or within the distances specified in Table D-1; or
- (3) on a clearway and which would endanger an aircraft in the air;
- should be frangible and mounted as low as possible.
- (d) Unless its function requires it to be there for air navigation or for aircraft safety purposes, or if after a safety assessment, it is determined that it would not adversely affect the safety or significantly affect the regularity of operations of aeroplanes, no equipment or installation should be located within 240 m from the end of the strip and within:
- (1) 60 m of the extended centre line where the code number is 3 or 4; or
- (2) 45 m of the extended centre line where the code number is 1 or 2;
- of a precision approach runway Category I, II or III.
- (e) Any equipment or installation required for air navigation or for aircraft safety purposes which should be located on or near a strip of a precision approach runway Category I, II, or III and which:
- (1) is situated on that portion of the strip within 77.5 m of the runway centre line where the code number is 4 and the code letter is F; or
- (2) is situated within 240 m from the end of the strip and within:
- (i) 60 m of the extended runway centre line where the code number is 3 or 4; or
- (ii) 45 m of the extended runway centre line where the code number is 1 or 2; or
- (3) penetrates the inner approach surface, the inner transitional surface, or the balked landing surface;
- should be frangible and mounted as low as possible.
- (f) Any equipment or installation required for air navigation or for aircraft safety purposes that is an obstacle of operational significance in accordance with [CS ADR-DSN.J.470\(d\)](#), [CS ADR-DSN.J.475\(e\)](#), [CS ADR-DSN.J.480\(g\)](#), or [CS ADR-DSN.J.485\(e\)](#) should be frangible and mounted as low as possible.
- (g) Any equipment or installation required for air navigation or for aircraft safety purposes which should be located on the non-graded portion of a runway strip should be regarded as an obstacle and should be frangible and mounted as low as possible.

[Issue: ADR-DSN/2]

[Issue: ADR-DSN/3]

## GM1 ADR-DSN.T.915 Siting of equipment and installations on operational areas

ED Decision 2021/004/R

- (a) The design of light fixtures and their supporting structures, light units of visual approach slope indicators, signs and markers is specified in [CS ADR-DSN.M.615](#), [CS ADR-DSN.M.640](#), [CS ADR-DSN.N.775](#), and the certification specifications of Chapter P respectively.
- (b) Guidance on siting of equipment and installations on operational areas is given in ICAO Doc 9157, Aerodrome Design Manuals, Part 2, Taxiways, Aprons and Holding Bays and Part 6, Frangibility.
- (c) Guidance on the frangible design of visual and non-visual aids for navigation is given in the ICAO Doc 9157, Aerodrome Design Manual, Part 5, Electrical Systems.
- (d) Requirements for obstacle limitation surfaces are specified in the certification specifications of Chapter J.

[Issue: ADR-DSN/3]

[Issue: ADR-DSN/5]

## CS ADR-DSN.T.920 Fencing

ED Decision 2014/013/R

- (a) The safety objective of fencing is to prevent animals or unauthorised persons that could be a safety risk to aircraft operations, to enter the aerodrome.
- (b) Fencing should be sited as far away from the runway and taxiway centre lines as practicable.
- (c) Suitable means of protection such as fence or other suitable barrier should be provided on an aerodrome to prevent the entrance to the aerodrome:
  - (1) by non-flying animals large enough to be a hazard to aircraft; and/or
  - (2) by an unauthorised person.

This includes the barring of sewers, ducts, tunnels, etc. where necessary to prevent access.

- (d) Suitable means of protection should be provided to deter the inadvertent or premeditated access of unauthorised persons into ground installations and facilities essential for the safety of civil aviation located off the aerodrome.

## GM1 ADR-DSN.T.920 Fencing

ED Decision 2016/027/R

- (a) The fence or barrier should be located so as to separate the movement area and other facilities or zones on the aerodrome vital to the safe operation of aircraft from areas open to public access.
- (b) Consideration should be given to the provision of a perimeter road inside the aerodrome fencing for the use of both maintenance personnel and security patrols.
- (c) Special measures may be required to prevent the access of an unauthorised person to runways or taxiways which overpass public roads.
- (d) Fencing can vary in design, height, and type depending on local needs. Generally, it is recommended that the fencing be galvanized steel, chain link fabric installed to a height of



2,5 m, and topped with a three-strand barbed wire overhang. The latter should have a minimum 15 cm separation between strands and extend outward at 45-degree angle from the horizontal. Fence posts should be installed at no greater than 3 m intervals and be located within 5 cm of any wall or structure forming part of the perimeter. Gates should be constructed with material of comparable strength and durability, and open to an angle of at least 90 degrees. Hinges should be such as to preclude unauthorised removal.

- (e) Top and bottom selvages of the fence having a twisted and barbed finish. The bottom of the fence installed to within 5 cm of hard surfacing or stabilised soil. However, in areas where unstable soil conditions are prevalent, the fabric installed to extend at least 5 cm below the surface or imbedded in concrete curbing. All fencing should be grounded. Care should be taken that metallic fencing is not installed when it should interface with the operation of navigation aids. The fence itself should allow clear visibility and easy maintenance.
- (f) The number of gates should be limited to the minimum required for the safe and efficient operation of the facility. Access points should need to be made in the fence to allow the passage of authorised vehicles and persons. While the number of access points should be kept to a minimum, adequate access points should be planned for routine operations, maintenance and emergency operations.

[Issue: ADR-DSN/3]

## **CS ADR-DSN.T.921 Autonomous runway incursion warning system (ARIWS)**

*ED Decision 2017/021/R*

- (a) **Applicability:** The inclusion of detailed specifications for an ARIWS is not intended to imply that an ARIWS has to be provided at an aerodrome.
- (b) **Characteristics:** Where an ARIWS is installed at an aerodrome:
  - (1) It should provide autonomous detection of a potential incursion or of the occupancy of an active runway and a direct warning to a flight crew or vehicle operator;
  - (2) It should function and be controlled independently of any other visual system on the aerodrome;
  - (3) Its visual aid components, i.e. lights, should be designed to conform with the relevant specifications in Chapter M; and
  - (4) Failure of the ARIWS or part of it should not interfere with normal aerodrome operations. To this end, provision should be made to allow air traffic services (ATS) unit to partially or entirely shut down the system.
- (c) Where an ARIWS is installed at an aerodrome, information on its characteristics and status should be provided to the appropriate aeronautical information services (AIS) for promulgation in the aeronautical information publication (AIP) with the description of the aerodrome surface movement guidance and control system and markings.

[Issue: ADR-DSN/4]

## GM1 ADR-DSN.T.921 Autonomous runway incursion warning system (ARIWS)

*ED Decision 2017/021/R*

- (a) The implementation of autonomous systems are generally quite complex in design and operation and, as such, deserves careful consideration by all involved parties such as aerodrome operators, air traffic services (ATS) and aircraft operators. This guidance provides a more clear description of the system(s) and offer some suggested actions required in order to properly implement this system(s) at an aerodrome.
- (b) An ARIWS may be installed in conjunction with enhanced taxiway centre line markings, stop bars or runway guard lights.
- (c) The system(s) should be operational under all weather conditions, including low visibility.
- (d) An ARIWS may share common sensory components of a surface movement guidance and control system (SMGCS) or advanced surface movement guidance and control system (A-SMGCS), however, it operates independently of either system.
- (e) General description:
  - (1) The operation of an ARIWS is based upon a surveillance system which monitors the actual situation on a runway and automatically returns this information to warning lights at the runway (take-off) thresholds and entrances. When an aircraft departs from a runway (rolling) or arrives at a runway (short final), red warning lights at the entrances will illuminate, indicating that it is unsafe to enter or cross the runway. When an aircraft is aligned on the runway for take-off and another aircraft or vehicle enters or crosses the runway, red warning lights will illuminate at the threshold area, indicating that it is unsafe to start the take-off roll.
  - (2) In general, an ARIWS consists of an independent surveillance system (primary radar, multilateration, specialised cameras, dedicated radar, etc.) and a warning system in the form of extra airfield lighting systems connected through a processor that generates alerts independent from the air traffic control (ATC) directly to the flight crews and vehicle operators.
  - (3) An ARIWS does not require circuit interleaving, secondary power supply or operational connection to other visual aid systems.
  - (4) In practice, not every entrance or threshold needs to be equipped with warning lights. Each aerodrome will have to assess its needs individually, depending on the characteristics of the aerodrome. There are several systems developed offering the same or similar functionality.
- (f) Flight crew actions:
  - (1) It is of critical importance that flight crews understand the warning being transmitted by the ARIWS system. Warnings are provided in near real-time directly to the flight crew because there is no time for 'relay' types of communications. In other words, a conflict warning generated to ATS which must then interpret the warning, evaluate the situation and communicate to the aircraft in question, would result in several seconds being taken up where each second is critical in the ability to stop the aircraft safely and prevent a potential collision. Pilots are presented with a globally consistent signal which means 'STOP IMMEDIATELY' and should be taught to react accordingly. Likewise, pilots receiving an ATS clearance to take-off or cross a runway, and seeing the red light array, should

STOP and advise ATS that they aborted/stopped because of the red lights. Again, the criticality of the timeline involved is so tight that there is no room for misinterpretation of the signal. It is of utmost importance that the visual signal be consistent around the world.

- (2) It also has to be stressed that the extinguishing of the red lights does not, in itself, indicate a clearance to proceed. That clearance is still required from ATC. The absence of red warning lights only means that potential conflicts have not been detected.
  - (3) In the event that a system becomes unserviceable, one of two things will occur. If the system fails in the extinguished condition, then no procedural changes need to be accomplished. The only thing that will happen is the loss of the automatic, independent warning system. Both ATS operations and flight crew procedures (in response to ATS clearances) will remain unchanged.
  - (4) Procedures should be developed to address the circumstance where the system fails in the illuminated condition. It will be up to the ATS and/or aerodrome operator to establish those procedures depending on their own circumstances. It must be remembered that flight crews are instructed to 'STOP' at all red lights. If the affected portion of the system, or the entire system, is shut off the situation is reverted to the extinguished scenario described in the previous paragraph.
- (g) Aerodromes:
- (1) An ARIWS does not have to be provided at all aerodromes. An aerodrome considering the installation of such a system may wish to assess its needs individually, depending on traffic levels, aerodrome geometry, ground taxi patterns, etc. Local user groups such as the local runway safety team (LRST) may be of assistance in this process. Also, not every runway or taxiway needs to be equipped with the lighting array(s), and not every installation requires a comprehensive ground surveillance system to feed information to the conflict detection computer.
  - (2) Although there may be local specific requirements, some basic system requirements are applicable to all ARIWS:
    - (i) the control system and energy power supply of the system should be independent from any other system in use at the aerodrome, especially the other parts of the lighting system;
    - (ii) the system should operate independently from ATS communications;
    - (iii) the system should provide a globally accepted visual signal that is consistent and instantly understood by crews; and
    - (iv) local procedures should be developed in the case of malfunction or failure of a portion of or the entire system.
- (h) Air traffic services:
- (1) The ARIWS is designed to be complementary to normal ATS functions, providing warnings to flight crews and vehicle operators when some conflict has been unintentionally created or missed during normal aerodrome operations. The ARIWS will provide a direct warning when, for example, ground control or tower (local) control has provided a clearance to hold short of a runway but the flight crew or vehicle operator has 'missed' the hold short portion of their clearance and the tower has issued a take-off or landing

clearance to that same runway, and the ‘non-read back’ by the flight crew or vehicle operator was missed by ATC.

- (2) In the case where a clearance has been issued and a crew reports a non-compliance due to ‘red lights’, or aborts because of ‘red lights’, then it is imperative that the controller assess the situation and provide additional instructions, as necessary. It may well be that the system has generated a false warning or that the potential incursion no longer exists; however, it may also be a valid warning. In any case, additional instructions and/or a new clearance need to be provided. In the case where the system has failed, then procedures will need to be put into place, as described in paragraphs (f)(3) and (f)(4) above. In no case should the illumination of the ARIWS be dismissed without confirmation that, in fact, there is no conflict. It is worth noting that there have been numerous incidents avoided at aerodromes with such systems installed. It is also worth noting that there have been false warnings as well, usually as a result of the calibration of the warning software, but in any case, the potential conflict existence or non-existence should be confirmed.
  - (3) While many installations may have a visual or audio warning available to ATS personnel, it is in no way intended that ATS personnel be required to actively monitor the system. Such warnings may assist ATS personnel in quickly assessing the conflict in the event of a warning and help them to provide appropriate further instructions, but the ARIWS should not play an active part in the normal functioning of any ATS facility.
  - (4) Each aerodrome where the system is installed should develop procedures depending upon its unique situation. Again, it has to be stressed that under no circumstances should pilots or operators be instructed to ‘cross the red lights’. As indicated above, the use of local runway safety teams may greatly assist in the development of this process.
- (i) Promulgation of information:
- (1) Specifications on providing information in the aeronautical information publication (AIP) are given in ICAO Annex 15, Aeronautical Information Services. Information on the characteristics and status of an ARIWS at an aerodrome is promulgated in the AIP Section AD 2.9, and its status updated as necessary through notice to airmen (NOTAM) or automatic terminal information service (ATIS).
  - (2) Aircraft operators are to ensure that flight crews’ documentation include procedures regarding ARIWS and appropriate guidance in compliance with ICAO Annex 6, Operation of Aircraft, Part I.
  - (3) Aerodromes may provide additional sources of guidance on operations and procedures for their personnel, aircraft operators, ATS and third-party personnel that may have to deal with an ARIWS.

[Issue: ADR-DSN/4]

## CHAPTER U — COLOURS FOR AERONAUTICAL GROUND LIGHTS, MARKINGS, SIGNS AND PANELS

### CS ADR-DSN.U.925 General

*ED Decision 2017/021/R*

- (a) The specifications in this Chapter define the chromaticity limits of colours to be used for aeronautical ground lights, markings, signs, and panels. The specifications are in accord with the specifications in the International Commission on Illumination (CIE), except for the colour orange in Figure U-2.
- (b) The chromaticity is expressed in terms of the standard observer and coordinate system adopted by the International Commission on Illumination (CIE).
- (c) The chromaticity for solid state lighting (e.g. LEDs) is based upon the boundaries given in Standard S 004/E-2001 of the International Commission on Illumination (CIE), except for the blue boundary of white.

[Issue: ADR-DSN/4]

### GM1 ADR-DSN.U.925 General

*ED Decision 2014/013/R*

It is not possible to establish specifications for colours such that there is no possibility of confusion. For reasonably certain recognition, it is important that the eye illumination be well above the threshold of perception, that the colour not be greatly modified by selective atmospheric attenuations and that the observer's colour vision be adequate. There is also a risk of confusion of colour at an extremely high level of eye illumination such as may be obtained from a high-intensity source at very close range. Experience indicates that satisfactory recognition can be achieved if due attention is given to these factors.

### CS ADR-DSN.U.930 Colours for aeronautical ground lights

*ED Decision 2017/021/R*

- (a) The chromaticity of aeronautical ground lights with filament-type light sources should be within the following boundaries:

CIE Equations (see Figure U-1A):

- (1) Red

Purple boundary  $y = 0.980 - x$ Yellow boundary  $y = 0.335$ Note: see [CS ADR-DSN.M.645\(c\)\(2\)\(i\)](#)

- (2) Yellow

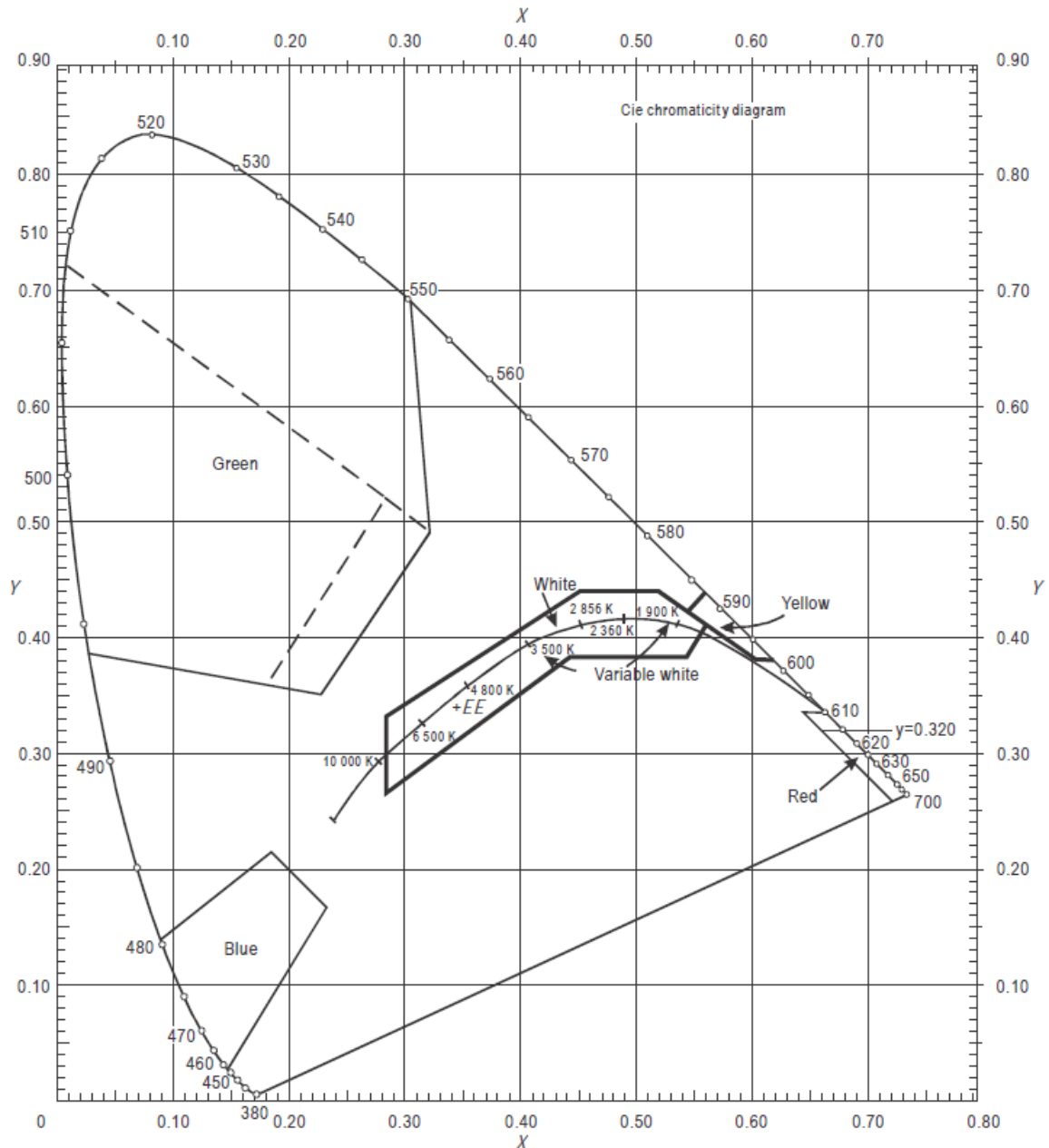
Red boundary  $y = 0.382$ White boundary  $y = 0.790 - 0.667x$ Green boundary  $y = x - 0.120$

- 
- (3) Green
- |                 |                      |
|-----------------|----------------------|
| Yellow boundary | $x = 0.360 - 0.080y$ |
| White boundary  | $x = 0.650y$         |
| Blue boundary   | $y = 0.390 - 0.171x$ |
- (4) Blue
- |                 |                      |
|-----------------|----------------------|
| Green boundary  | $y = 0.805x + 0.065$ |
| White boundary  | $y = 0.400 - x$      |
| Purple boundary | $x = 0.600y + 0.133$ |
- (5) White
- |                 |                                      |
|-----------------|--------------------------------------|
| Yellow boundary | $x = 0.500$                          |
| Blue boundary   | $x = 0.285$                          |
| Green boundary  | $y = 0.440$ and $y = 0.150 + 0.640x$ |
| Purple boundary | $y = 0.050 + 0.750x$ and $y = 0.382$ |
- (6) Variable white
- |                 |                                               |
|-----------------|-----------------------------------------------|
| Yellow boundary | $x = 0.255 + 0.750y$ and $y = 0.790 - 0.667x$ |
| Blue boundary   | $x = 0.285$                                   |
| Green boundary  | $y = 0.440$ and $y = 0.150 + 0.640x$          |
| Purple boundary | $y = 0.050 + 0.750x$ and $y = 0.382$          |
- (b) Where increased certainty of recognition from white is more important than maximum visual range, green signals should be within the following boundaries:
- |                     |                      |
|---------------------|----------------------|
| (1) Yellow boundary | $y = 0.726 - 0.726x$ |
| (2) White boundary  | $x = 0.625y - 0.041$ |
| (3) Blue boundary   | $y = 0.390 - 0.171x$ |
- (c) Discrimination between lights having filament-type sources:
- (1) If there is a requirement to discriminate yellow and white from each other, they should be displayed in close proximity of time or space as, for example, by being flashed successively from the same beacon.
  - (2) If there is a requirement to discriminate yellow from green and/or white, as for example on exit taxiway centre line lights, the y coordinates of the yellow light should not exceed a value of 0.40. The limits of white have been based on the assumption that they should be used in situations in which the characteristics (colour temperature) of the light source should be substantially constant.
  - (3) The colour variable white is intended to be used only for lights that are to be varied in intensity, e.g. to avoid dazzling. If this colour is to be discriminated from yellow, the lights should be so designed and operated that:
    - (i) the x coordinate of the yellow is at least 0.050 greater than the x coordinate of the white; and

- (ii) the disposition of the lights should be such that the yellow lights are displayed simultaneously and in close proximity to the white lights.
- (d) The chromaticity of aeronautical ground lights with solid state light sources, e.g. LEDs, should be within the following boundaries:
- CIE Equations (see Figure U-1B):
- (1) Red
- Purple boundary  $y = 0.980 - x$
- Yellow boundary  $y = 0.335$ ;
- Yellow boundary  $y = 0.320$ .
- Note: see [CS ADR-DSN.M.645\(c\)\(2\)\(i\)](#)
- (2) Yellow
- Red boundary  $y = 0.387$
- White boundary  $x = 0.980 - x$
- Green boundary  $y = 0.727x + 0.054$
- (3) Green (refer also to [GM1 ADR-DSN.U.930\(d\) and \(e\)](#))
- Yellow boundary  $x = 0.310$
- White boundary  $x = 0.625y - 0.041$
- Blue boundary  $y = 0.400$
- (4) Blue
- Green boundary  $y = 1.141x - 0.037$
- White boundary  $x = 0.400 - y$
- Purple boundary  $x = 0.134 + 0.590y$
- (5) White
- Yellow boundary  $x = 0.440$
- Blue boundary  $x = 0.320$
- Green boundary  $y = 0.150 + 0.643x$
- Purple boundary  $y = 0.050 + 0.757x$
- (6) Variable white
- The boundaries of variable white for solid state light sources are those specified in [CS ADR-DSN.U.930\(d\)\(5\)](#) above.
- (e) Colour measurement for filament-type and solid state light sources:
- (1) The colour of aeronautical ground lights should be verified as being within the boundaries specified in Figure U-1A or U-1B, as appropriate, by measurement at five points within the area limited by the innermost isocandela curve in the isocandela diagrams in [CS ADR DSN.U.940](#), with operation at rated current or voltage. In the case of elliptical or circular isocandela curves, the colour measurements should be taken at the centre and at the horizontal and vertical limits. In the case of rectangular isocandela curves, the colour

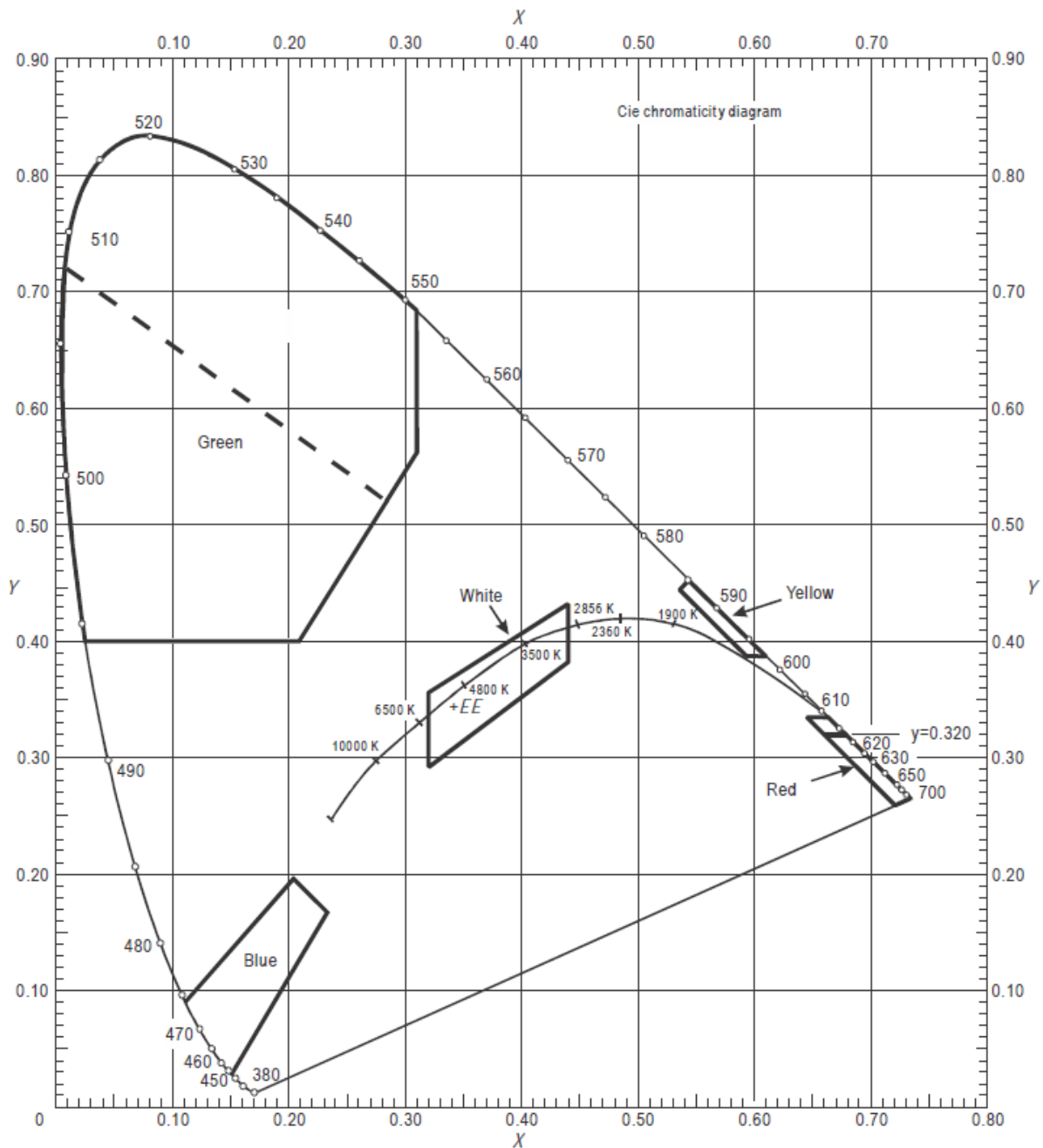
measurements should be taken at the centre and the limits of the diagonals (corners). In addition, the colour of the light should be checked at the outermost isocandela curve to ensure that there is no colour shift that might cause signal confusion to the pilot.

- (2) In the case of visual approach slope indicators and other light units having a colour transition sector, the colour should be measured at points in accordance with paragraph [CS ADR-DSN.U.930\(e\)\(1\)](#) above, except that the colour areas should be treated separately and no point should be within 0.5 degrees of the transition sector.



**Figure U-1A. Colours for aeronautical ground lights (filament-type lamps)**





**Figure U-1B. Colours for aeronautical ground lights (solid state lighting)**

[Issue: ADR-DSN/3]

[Issue: ADR-DSN/4]

## GM1 ADR-DSN.U.930 Colours for aeronautical ground lights

*ED Decision 2017/021/R*

- (a) The chromaticity for ground lights with filament-type light sources, where dimming is not required, or where observers with defective colour vision should be able to determine the colour of the light, green signals should be within the following boundaries:

Yellow boundary  $y = 0.726 - 0.726x$

- White boundary  $x = 0.650y$   
Blue boundary  $y = 0.390 - 0.171x$
- (b) Guidance on chromaticity changes resulting from the effect of temperature on filtering elements is given in ICAO Doc 9157, Aerodrome Design Manual, Part 4, Visual Aids.
- (c) Where the colour signal is to be seen from long range, the current practice is to use colours within the boundaries specified in paragraph (a) above.
- (d) For the chromaticity of ground lights with solid-state light sources, where observers with defective colour vision should be able to determine the colour of the light, green signals should be within the following boundaries:  
Yellow boundary  $y = 0.726 - 0.726x$   
White boundary  $x = 0.625y - 0.041$   
Blue boundary  $y = 0.400$
- (e) For the chromaticity of ground lights having a solid state light source, in order to avoid a large variation of shades of green, and if colours within the boundaries below are selected, colours within the boundaries specified in paragraph (d) above should not be used:  
Yellow boundary  $x = 0.310$   
White boundary  $x = 0.625y - 0.041$   
Blue boundary  $y = 0.726 - 0.726x$
- (f) Colour measurement for filament-type and solid state-type light sources:  
(1) for the outermost isocandela curve, a measurement of colour coordinates should be made and recorded for review and judgement of acceptability; and  
(2) certain light units may have an application so that they may be viewed and used by pilots from directions beyond that of the outermost isocandela curve (e.g. stop bar lights at significantly wide runway-holding positions); then an assessment of the actual application should be conducted and, if necessary, a check of colour shift at angular ranges beyond the outermost curve carried out.

[Issue: ADR-DSN/3]

[Issue: ADR-DSN/4]

## CS ADR-DSN.U.935 Colours for markings, signs and panels

ED Decision 2016/027/R

- (a) The specifications in surface colours given below apply only to freshly coloured surfaces. Colours used for markings, signs, and panels usually change with time and, therefore, require renewal.
- (b) The specifications in paragraph (f) below for internally illuminated panels are interim in nature and are based on the CIE specifications for internally illuminated signs. It is intended that these specifications should be reviewed and updated as and when CIE develops specifications for internally illuminated panels.
- (c) The chromaticities and luminance factors of ordinary colours, colours of retroreflective materials, and colours of internally illuminated (internally illuminated) signs and panels should be determined under the following standard conditions:

- (1) angle of illumination: 45°;
  - (2) direction of view: perpendicular to surface; and
  - (3) illuminant: CIE standard illuminant D65.
- (d) The chromaticity and luminance factors of ordinary colours for markings and externally illuminated signs and panels should be within the following boundaries when determined under standard conditions.

CIE Equations (see Figure U-2):

(1) Red

Purple boundary	$y = 0.345 - 0.051x$
White boundary	$y = 0.910 - x$
Orange boundary	$y = 0.314 + 0.047x$
Luminance factor	$\beta = 0.07$ (minimum)

(2) Orange

Red boundary	$y = 0.285 + 0.100x$
White boundary	$y = 0.940 - x$
Yellow boundary	$y = 0.250 + 0.220x$
Luminance factor	$\beta = 0.20$ (minimum)

(3) Yellow

Orange boundary	$y = 0.108 + 0.707x$
White boundary	$y = 0.910 - x$
Green boundary	$y = 1.35x - 0.093$
Luminance factor	$\beta = 0.45$ (minimum)

(4) White

Purple boundary	$y = 0.010 + x$
Blue boundary	$y = 0.610 - x$
Green boundary	$y = 0.030 + x$
Yellow boundary	$y = 0.710 - x$
Luminance factor	$\beta = 0.75$ (minimum)

(5) Black

Purple boundary	$y = x - 0.030$
Blue boundary	$y = 0.570 - x$
Green boundary	$y = 0.050 + x$
Yellow boundary	$y = 0.740 - x$
Luminance factor	$\beta = 0.03$ (maximum)

- (6) Yellowish green
- |                 |                    |
|-----------------|--------------------|
| Green boundary  | $y = 1.317x + 0.4$ |
| White boundary  | $y = 0.910 - x$    |
| Yellow boundary | $y = 0.867x + 0.4$ |

- (7) Green
- |                  |                          |
|------------------|--------------------------|
| Yellow boundary  | $x = 0.313$              |
| White boundary   | $y = 0.243 + 0.670x$     |
| Blue boundary    | $y = 0.493 - 0.524x$     |
| Luminance factor | $\beta = 0.10$ (minimum) |

The small separation between surface red and surface orange is not sufficient to ensure the distinction of these colours when seen separately.

- (e) The chromaticity and luminance factors of colours of retroreflective materials for markings, signs, and panels should be within the following boundaries when determined under standard conditions.

CIE Equations (see Figure U-3):

- (1) Red
- |                  |                          |
|------------------|--------------------------|
| Purple boundary  | $y = 0.345 - 0.051x$     |
| White boundary   | $y = 0.910 - x$          |
| Orange boundary  | $y = 0.314 + 0.047x$     |
| Luminance factor | $\beta = 0.03$ (minimum) |
- (2) Orange
- |                  |                          |
|------------------|--------------------------|
| Red boundary     | $y = 0.265 + 0.205x$     |
| White boundary   | $y = 0.910 - x$          |
| Yellow boundary  | $y = 0.207 + 0.390x$     |
| Luminance factor | $\beta = 0.14$ (minimum) |
- (3) Yellow
- |                  |                          |
|------------------|--------------------------|
| Orange boundary  | $y = 0.160 + 0.540x$     |
| White boundary   | $y = 0.910 - x$          |
| Green boundary   | $y = 1.35x - 0.093$      |
| Luminance factor | $\beta = 0.16$ (minimum) |
- (4) White
- |                 |                 |
|-----------------|-----------------|
| Purple boundary | $y = x$         |
| Blue boundary   | $y = 0.610 - x$ |
| Green boundary  | $y = 0.040 + x$ |
| Yellow boundary | $y = 0.710 - x$ |

	Luminance factor	$\beta = 0.27$ (minimum)
(5)	Blue	
	Green boundary	$y = 0.118 + 0.675x$
	White boundary	$y = 0.370 - x$
	Purple boundary	$y = 1.65x - 0.187$
	Luminance factor	$\beta = 0.01$ (minimum)
(6)	Green	
	Yellow boundary	$y = 0.711 - 1.22x$
	White boundary	$y = 0.243 + 0.670x$
	Blue boundary	$y = 0.405 - 0.243x$
	Luminance factor	$\beta = 0.03$ (minimum)
(f)	The chromaticity and luminance factors of colours for luminescent or internally illuminated signs and panels should be within the following boundaries when determined under standard conditions.	
	CIE Equations (see Figure U-4):	
(1)	Red	
	Purple boundary	$y = 0.345 - 0.051x$
	White boundary	$y = 0.910 - x$
	Orange boundary	$y = 0.314 + 0.047x$
	Luminance factor	
	(day condition)	$\beta = 0.07$ (minimum)
	Relative luminance	
	to white (night condition)	5 % (minimum)    20 % (max)
(2)	Yellow	
	Orange boundary	$y = 0.108 + 0.707x$
	White boundary	$y = 0.910 - x$
	Green boundary	$y = 1.35x - 0.093$
	Luminance factor	
	(day condition)	$\beta = 0.45$ (minimum)
	Relative luminance	
	to white (night condition)	30 % (minimum)    80 % (max)
(3)	White	
	Purple boundary	$y = 0.010 + x$
	Blue boundary	$y = 0.610 - x$
	Green boundary	$y = 0.030 + x$

	Yellow boundary	$y = 0.710 - x$	
	Luminance factor (day condition)	$\beta = 0.75$ (minimum)	
	Relative luminance to white (night conditions)	100 %	
(4)	Black		
	Purple boundary	$y = x - 0.030$	
	Blue boundary	$y = 0.570 - x$	
	Green boundary	$y = 0.050 + x$	
	Yellow boundary	$y = 0.740 - x$	
	Luminance factor (day condition)	$\beta = 0.03$ (max)	
	Relative luminance to white (night condition)	0 % (minimum)    2 % (maximum)	
(5)	Green		
	Yellow boundary	$x = 0.313$	
	White boundary	$y = 0.243 + 0.670x$	
	Blue boundary	$y = 0.493 - 0.524x$	
	Luminance factor (day conditions)	$\beta = 0.10$ minimum	
	Relative luminance to white (night conditions)	5 % (minimum)    30 % (maximum)	

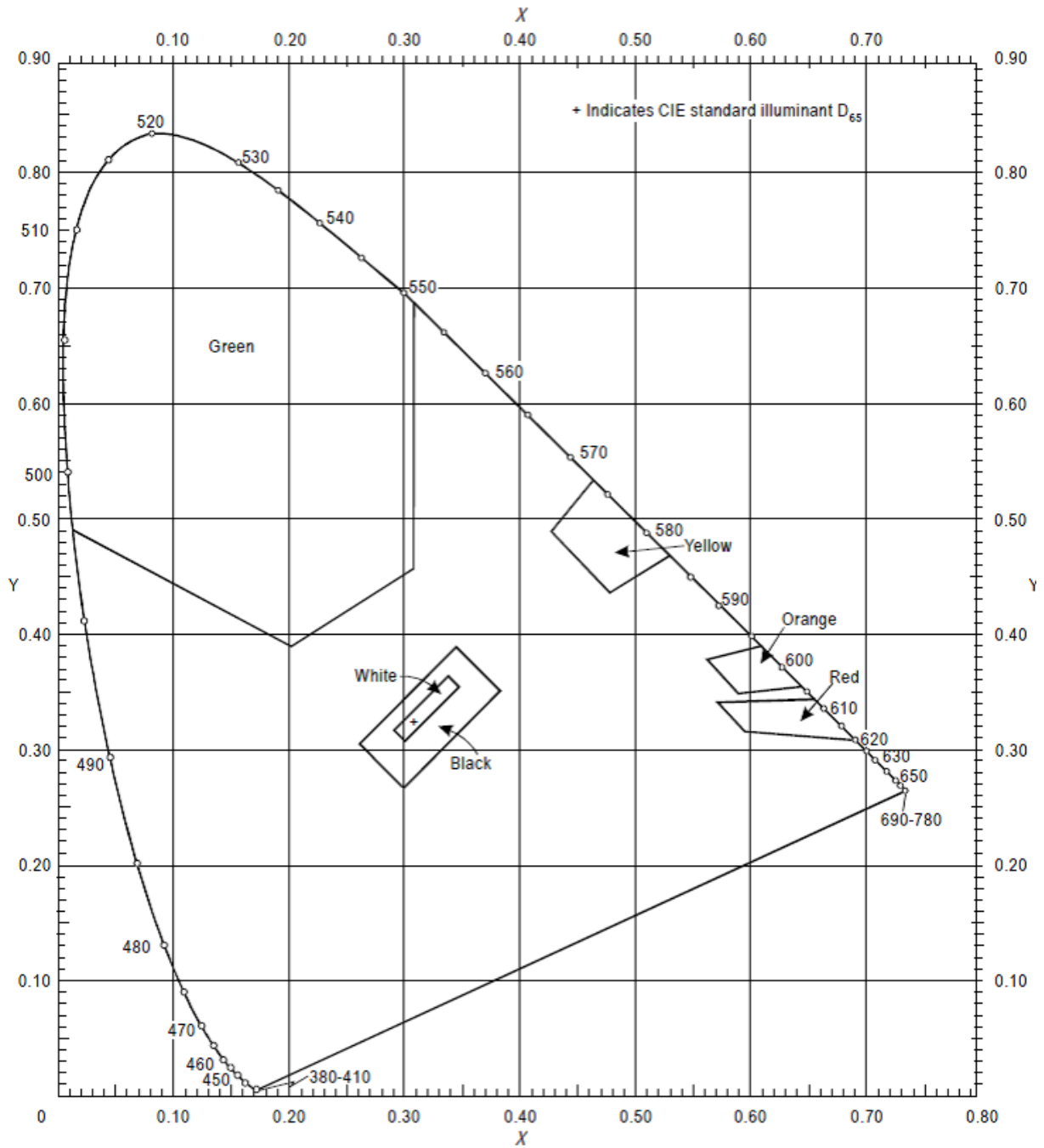


Figure U-2. Ordinary colours for markings and externally illuminated signs and panels

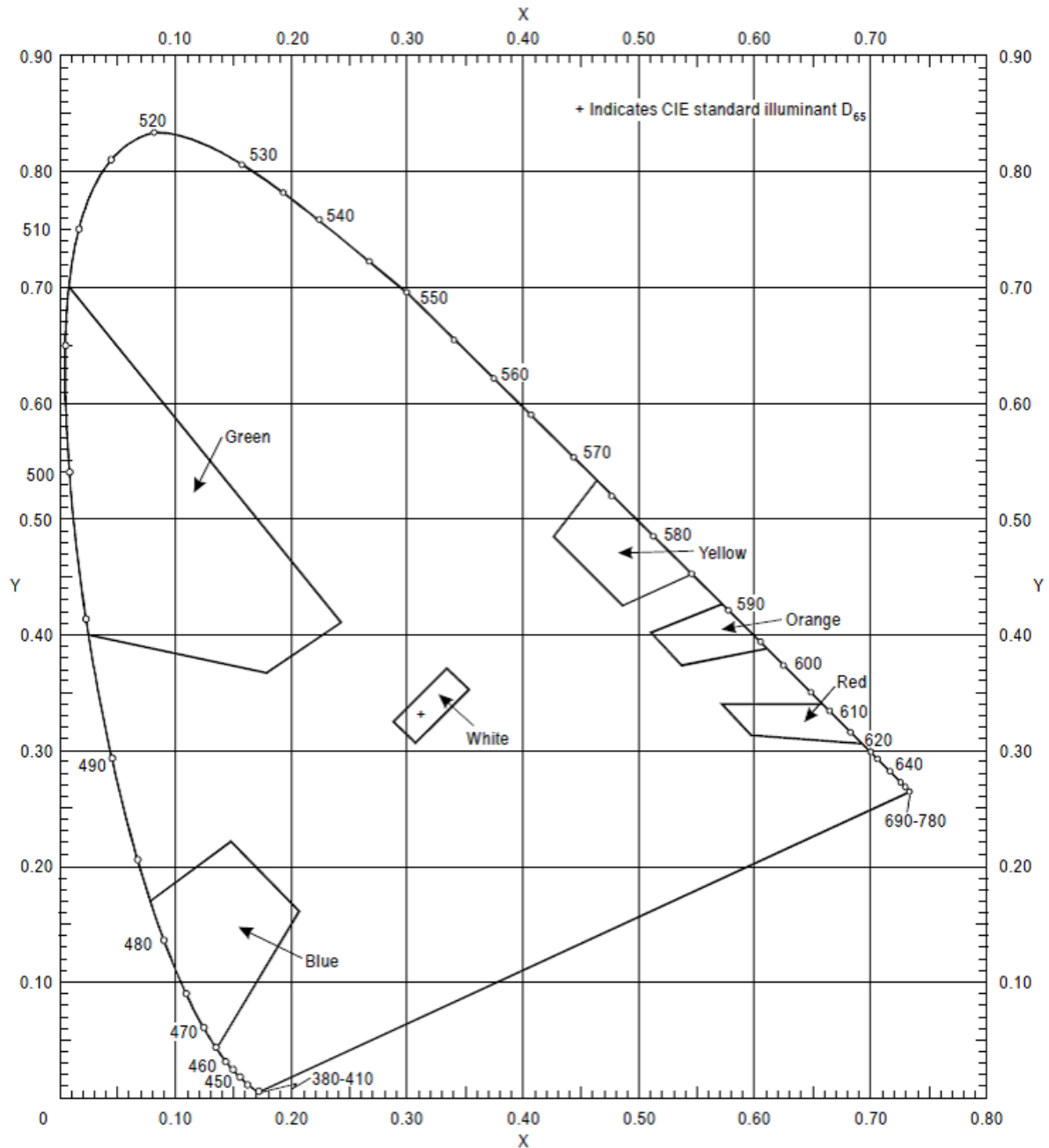


Figure U-3. Colours of retroreflective materials for markings, signs and panels



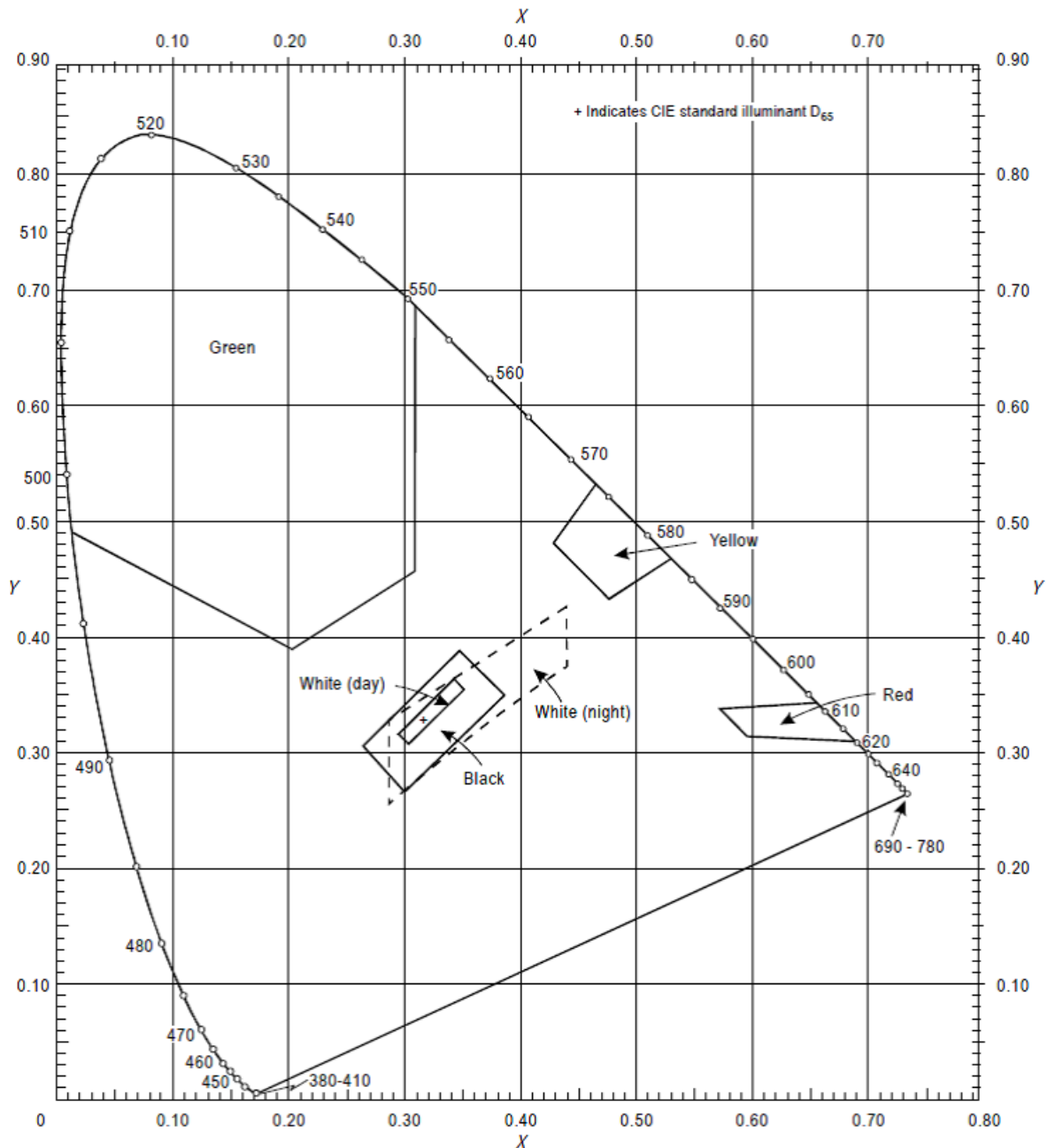


Figure U-4. Colours of luminescent or internally illuminated signs and panels

[Issue: ADR-DSN/3]

## GM1 ADR-DSN.U.935 Colours for markings, signs and panels

ED Decision 2014/013/R

intentionally left blank

## CS ADR-DSN.U.940 Aeronautical ground light characteristics

ED Decision 2017/021/R

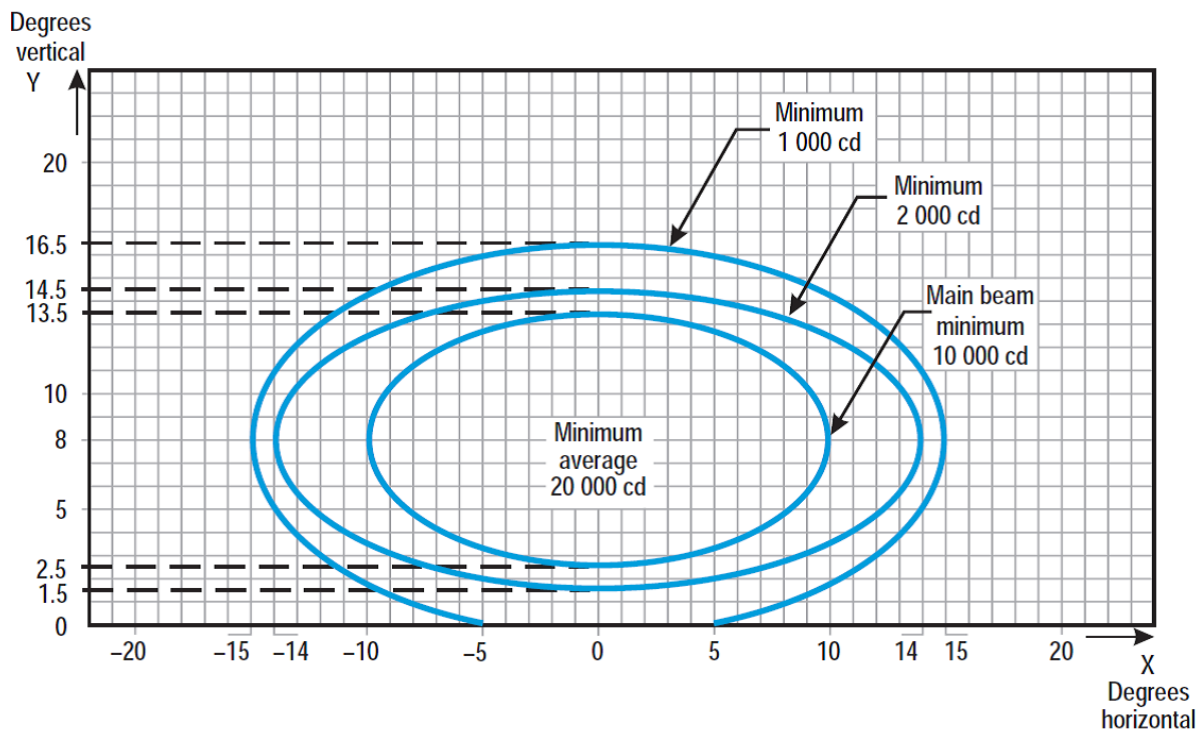


Figure U-5. Isocandela diagram for approach centre line light and crossbars (white light)

Notes:

(a) Curves calculated on formula

$$\frac{x^2}{a^2} + \frac{y^2}{b^2} = 1$$

a	10	14	15
b	5.5	6.5	8.5

(b) Vertical setting angles of the lights should be such that the following vertical coverage of the main beam should be met:

distance from threshold	vertical main beam coverage
threshold to 315 m	0° - 11°
316 m to 475 m	0.5° - 11.5°
476 m to 640 m	1.5° - 12.5°
641 m and beyond	2.5° -13.5° (as illustrated above)

- (c) Lights in crossbars beyond 22.5 m from the centre line should be toed-in 2 degrees. All other lights should be aligned parallel to the centre line of the runway.
- (d) See collective notes for Figures U-5 to U-15.

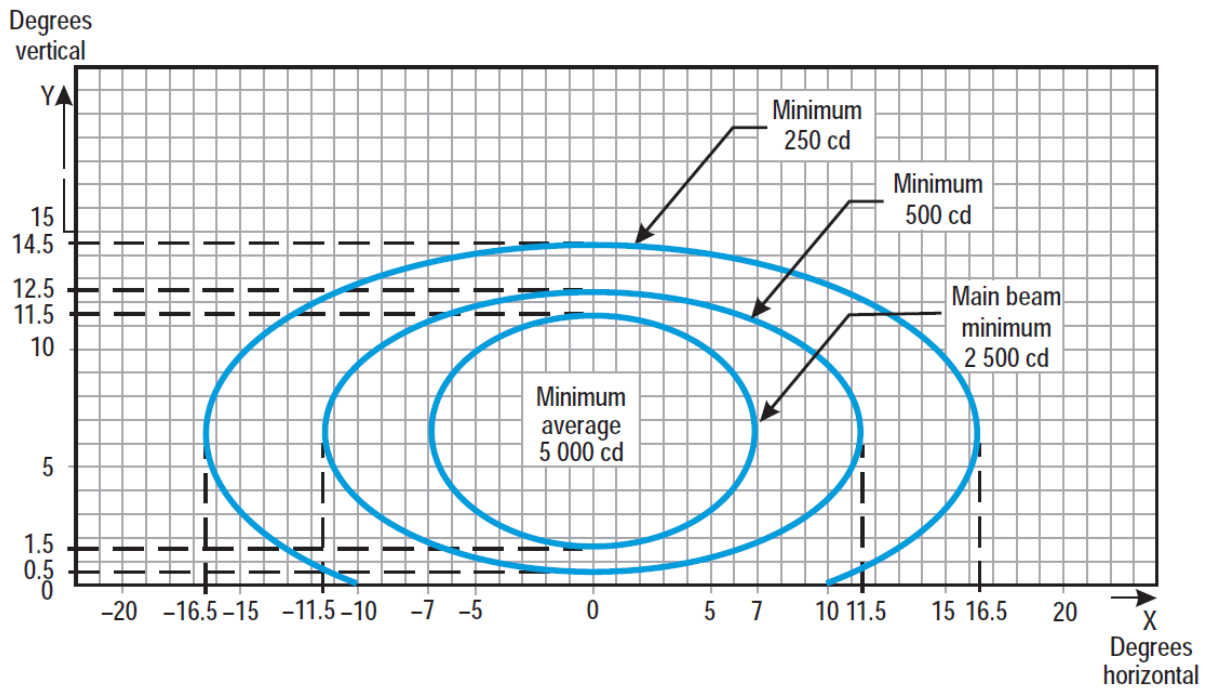


Figure U-6. Isocandela diagram for approach side row light (red light)

Notes:

(a) Curves calculated on formula

$$\frac{x^2}{a^2} + \frac{y^2}{b^2} = 1$$

a	7.0	11.5	16.5
b	5.0	6.0	8.0

(b) Toe-in 2 degrees

(c) Vertical setting angles of the lights should be such that the following vertical coverage of the main beam should be met:

distance from threshold	vertical main beam coverage
threshold to 115 m	0.5° - 10.5°
116 m to 215 m	1° - 11°
216 m and beyond	1.5° - 11.5° (as illustrated above)

(d) See collective notes for Figures U-5 to U-15.

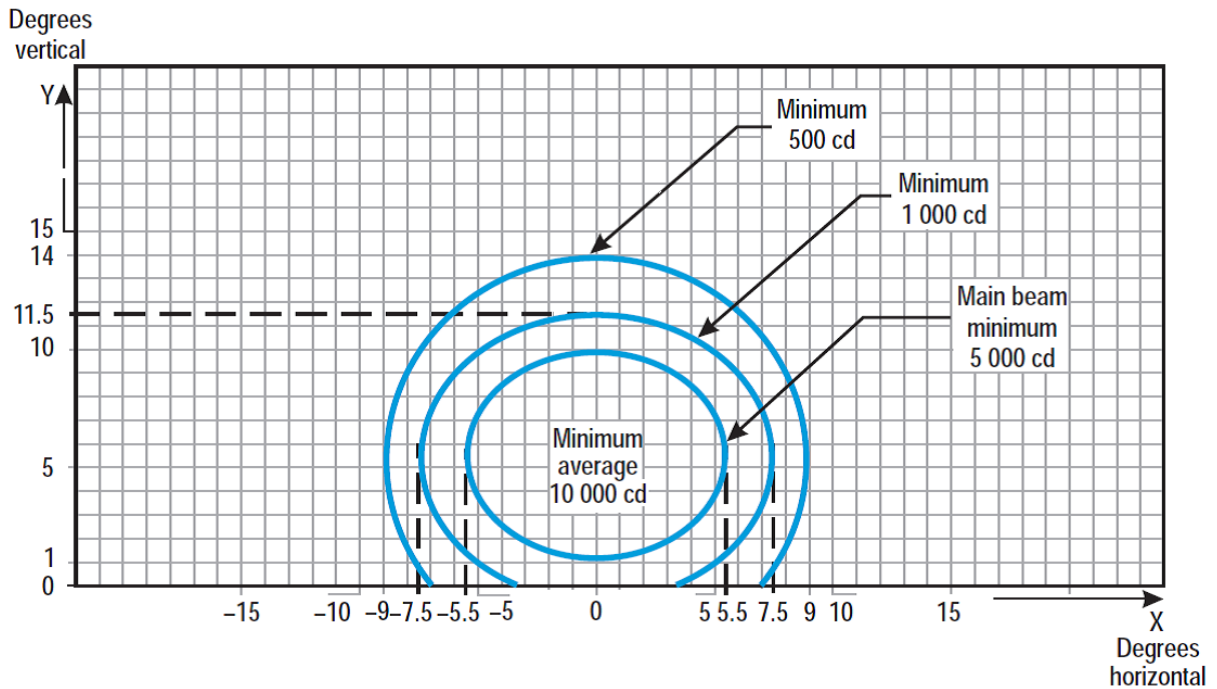


Figure U-7. Isocandela diagram for threshold light (green light)

Notes:

(a) Curves calculated on formula

$$\frac{x^2}{a^2} + \frac{y^2}{b^2} = 1$$

a	5.5	7.5	9.0
b	4.5	6.0	8.5

(b) Toe-in 3.5 degrees

(c) See collective notes for Figures U-5 to U-15.

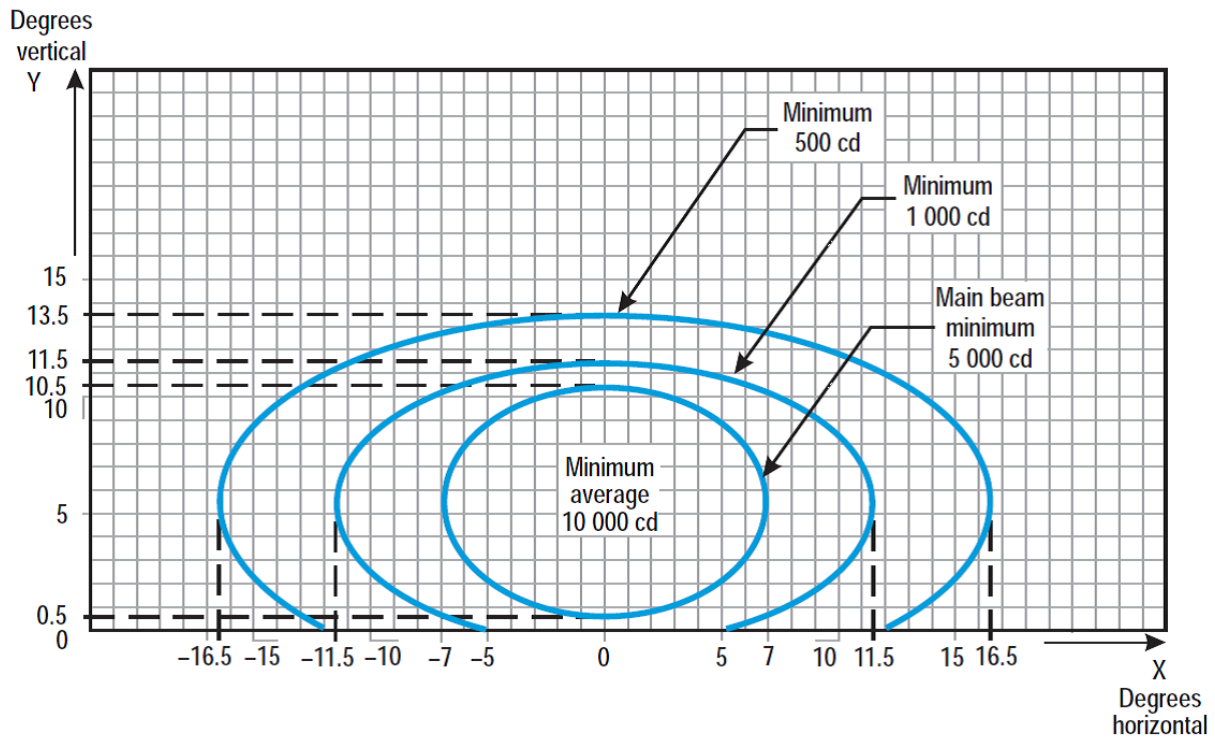


Figure U-8. Isocandela diagram for threshold wing bar light (green light)

Notes:

(a) Curves calculated on formula

$$\frac{x^2}{a^2} + \frac{y^2}{b^2} = 1$$

a	7.0	11.5	16.5
b	5.0	6.0	8.0

(b) Toe-in 2 degrees

(c) See collective notes for Figures U-5 to U-15.

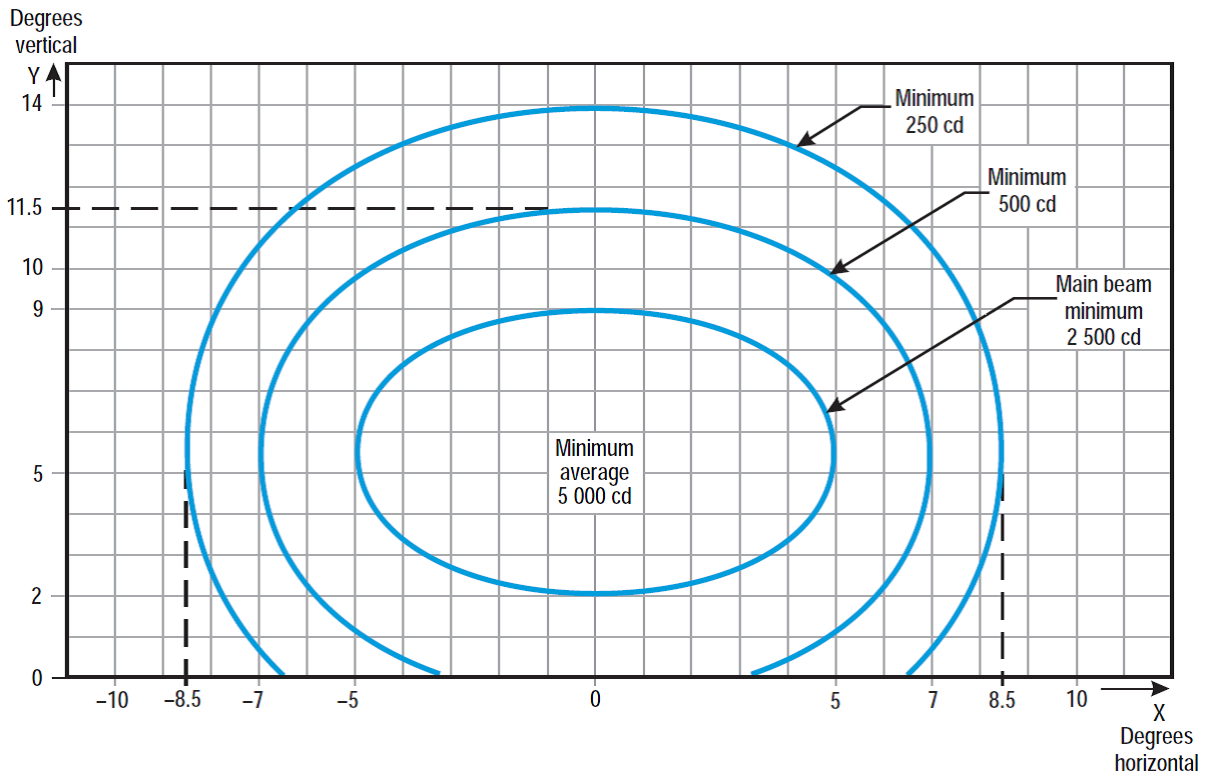


Figure U-9. Isocandela diagram for touchdown zone light (white light)

Notes:

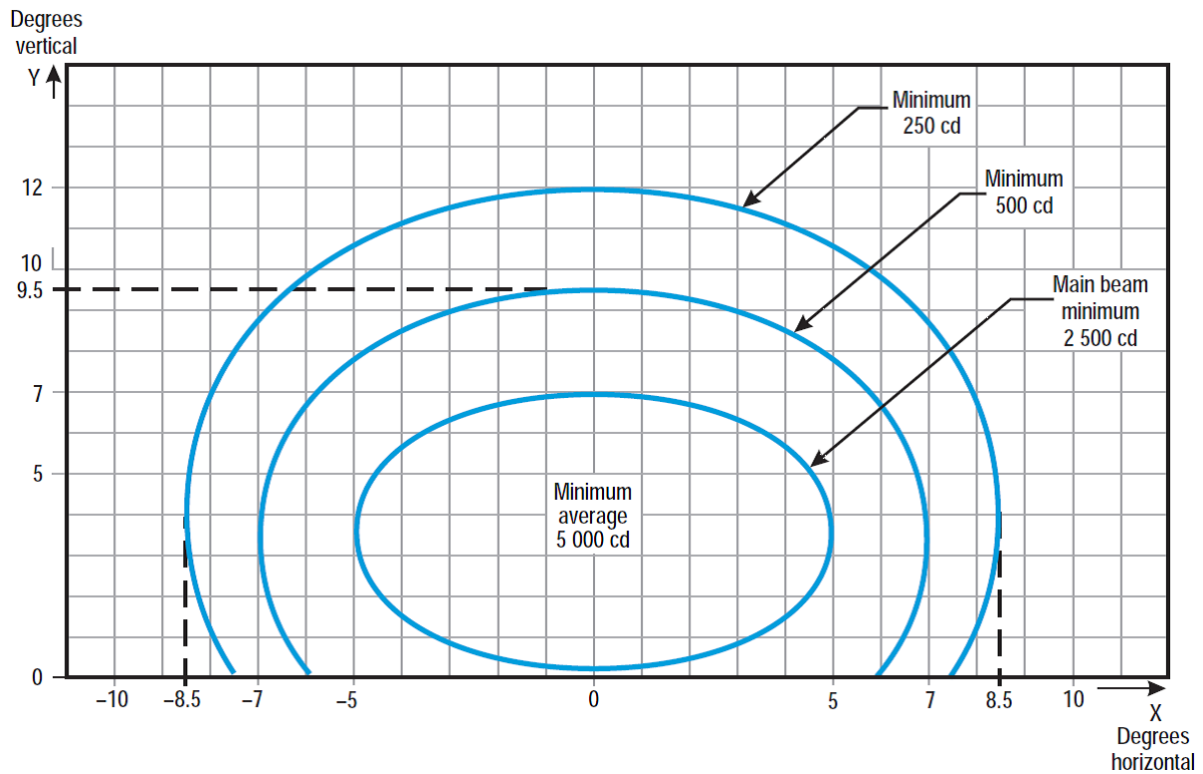
(a) Curves calculated on formula

$$\frac{x^2}{a^2} + \frac{y^2}{b^2} = 1$$

a	5.0	7.0	8.5
b	3.5	6.0	8.5

(b) Toe-in 4 degrees

(c) See collective notes for Figures U-5 to U-15.



**Figure U-10. Isocandela diagram for runway centre line light with 30 m longitudinal spacing (white light) and rapid exit taxiway indicator light (yellow light)**

Notes:

(a) Curves calculated on formula

$$\frac{x^2}{a^2} + \frac{y^2}{b^2} = 1$$

<b>a</b>	5.0	7.0	8.5
<b>b</b>	3.5	6.0	8.5

(b) For red light, multiply values by 0.15.

(c) For yellow light, multiply values by 0.40.

(d) See collective notes for Figures U-5 to U-15.

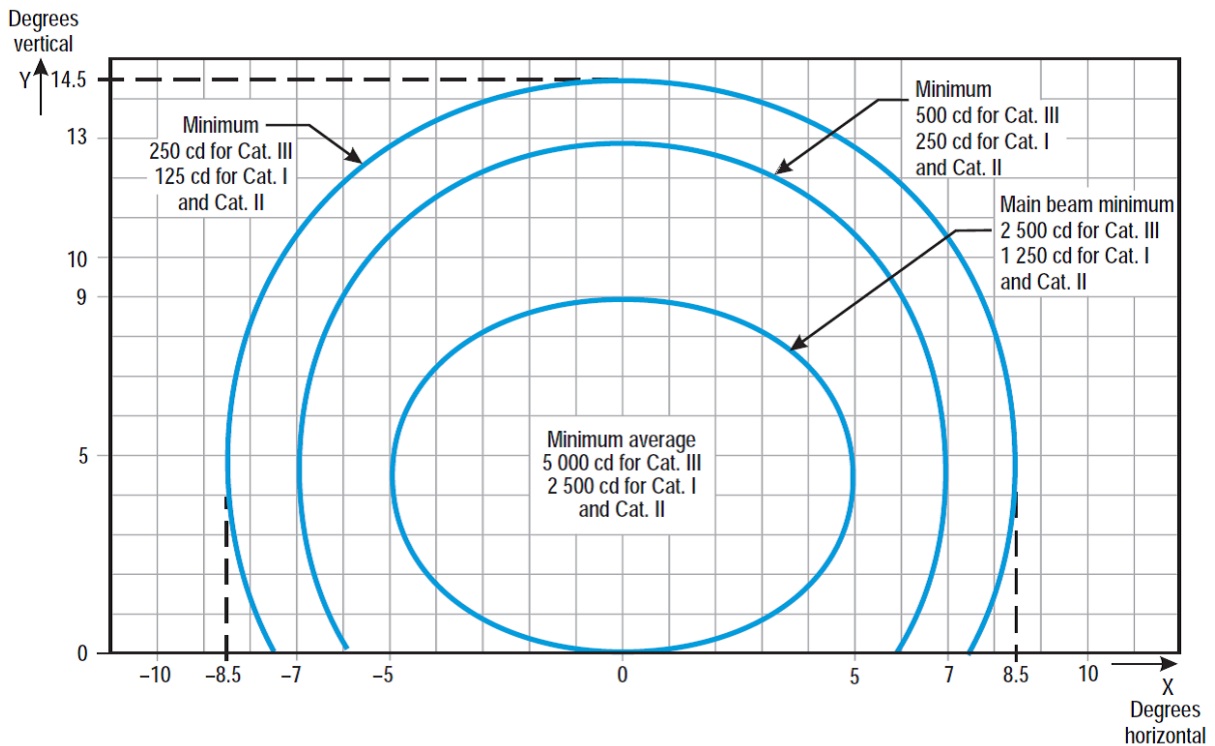


Figure U-11. Isocandela diagram for runway centre line light with 15 m longitudinal spacing (white light) and rapid exit taxiway indicator light (yellow light)

Notes:

(a) Curves calculated on formula

$$\frac{x^2}{a^2} + \frac{y^2}{b^2} = 1$$

a	5.0	7.0	8.5
b	3.5	6.0	8.5

(b) For red light, multiply values by 0.15.

(c) For yellow light, multiply values by 0.40.

(d) See collective notes for Figures U-5 to U-15.



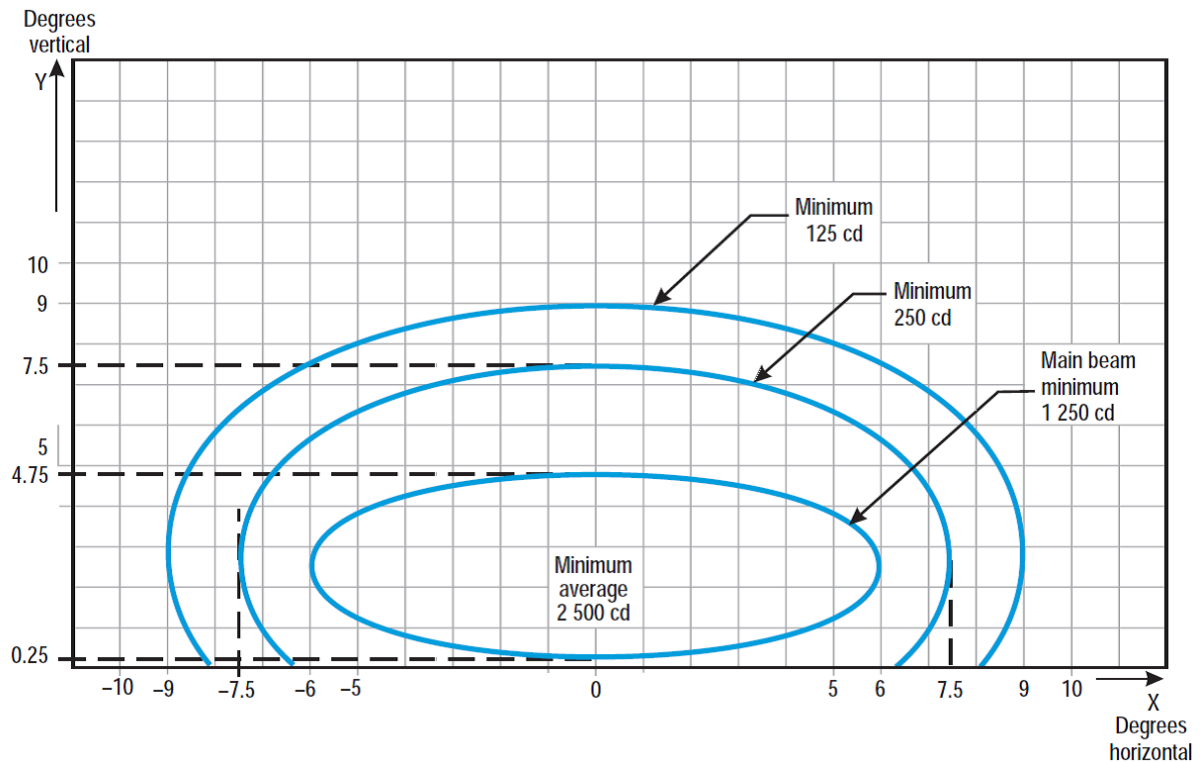


Figure U-12. Isocandela diagram for runway end light (red light)

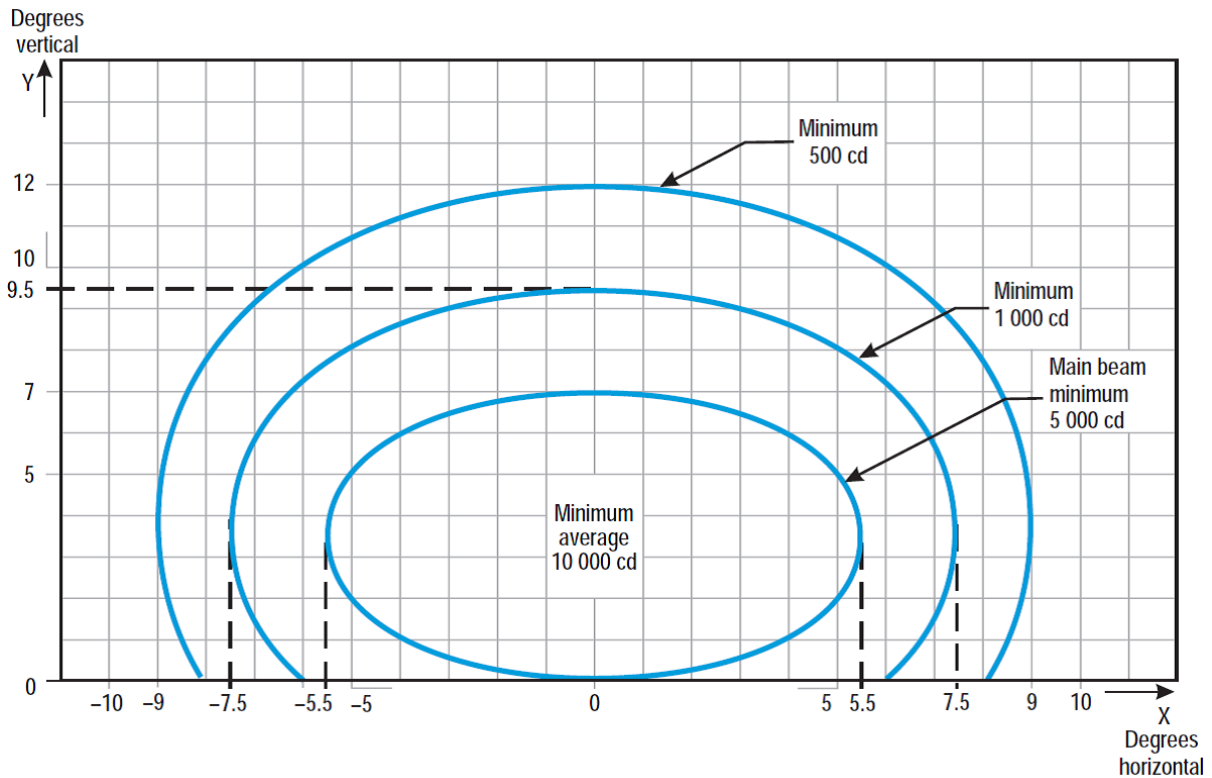
Notes:

(a) Curves calculated on formula

$$\frac{x^2}{a^2} + \frac{y^2}{b^2} = 1$$

<b>a</b>	6.0	7.5	9.0
<b>b</b>	2.25	5.0	6.5

(b) See collective notes for Figures U-5 to U-15.



**Figure U-13. Isocandela diagram for runway edge light where width of runway is 45 m (white light)**

Notes:

(a) Curves calculated on formula

$$\frac{x^2}{a^2} + \frac{y^2}{b^2} = 1$$

a	5.5	7.5	9.0
b	3.5	6.0	8.5

- (b) Toe-in 3.5 degrees
- (c) For red light, multiply values by 0.15.
- (d) For yellow light, multiply values by 0.40.
- (e) See collective notes for Figures U-5 to U-15.

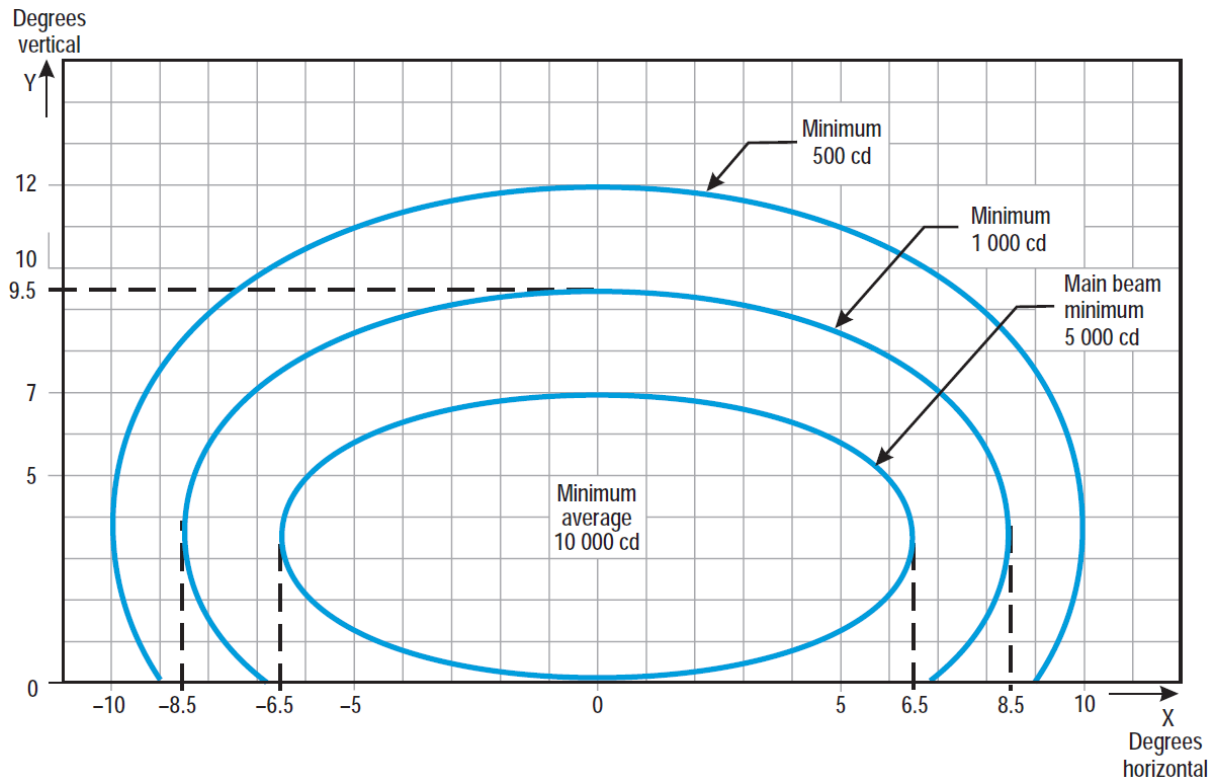


Figure U-14. Isocandela diagram for runway edge light where width of runway is 60 m (white light)

Notes:

(a) Curves calculated on formula

$$\frac{x^2}{a^2} + \frac{y^2}{b^2} = 1$$

a	6.5	8.5	10.0
b	3.5	6.0	8.5

- (b) Toe-in 4.5 degrees
- (c) For red light, multiply values by 0.15.
- (d) For yellow light, multiply values by 0.40.
- (e) See collective notes for Figures U-5 to U-15.

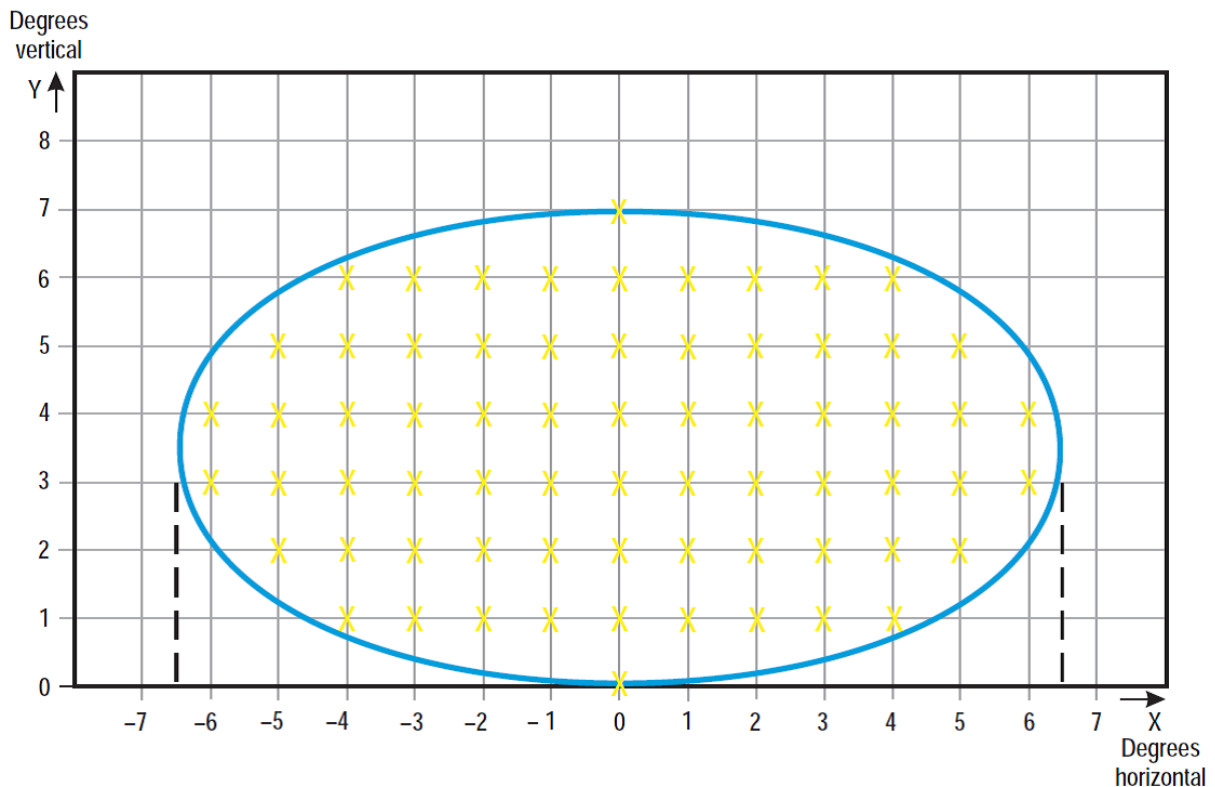


Figure U-15. Grid points to be used for the calculation of average intensity of approach and runway lights

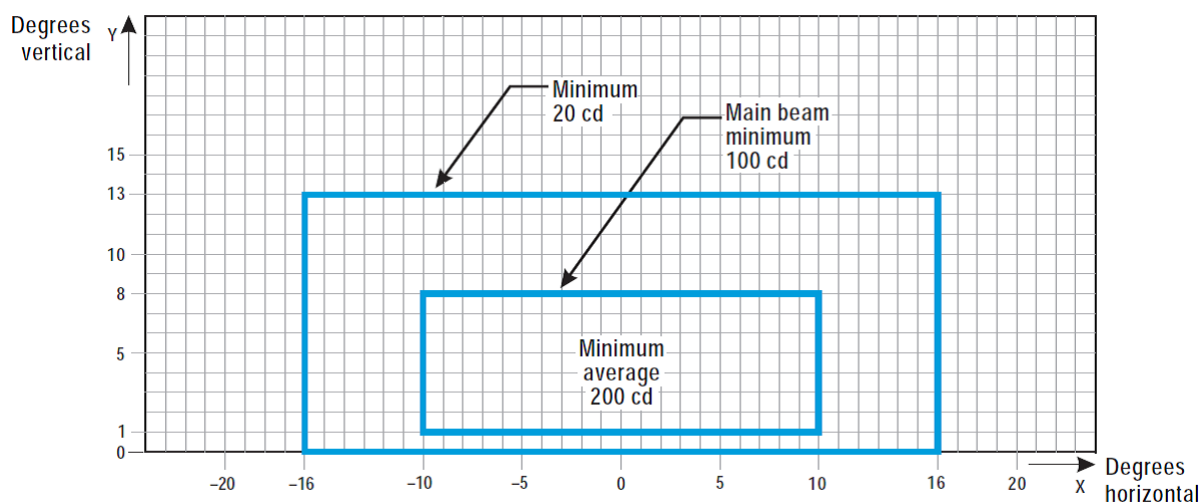
#### Collective notes to Figures U-5 to U-15

- (a) The ellipses in each Figure are symmetrical about the common vertical and horizontal axes.
- (b) Figures U-5 to U-14 show the minimum allowable light intensities. The average intensity of the main beam is calculated by establishing grid points as shown in Figure U-15 and using the intensity value measures at all grid points located within and on the perimeter of the ellipse representing the main beam. The average value is the arithmetic average of light intensities measured at all considered grid points.
- (c) No deviations are acceptable in the main beam pattern when the lighting fixture is properly aimed.
- (d) Average intensity ratio. The ratio between the average intensity within the ellipse defining the main beam of a typical new light and the average light intensity of the main beam of a new runway edge light should be as follows:

Figure U-5	Approach centre line and crossbars	1.5 to 2.0	(white light)
Figure U-6	Approach side row	0.5 to 1.0	(red light)
Figure U-7	Threshold	1.0 to 1.5	(green light)
Figure U-8	Threshold wing bar	1.0 to 1.5	(green light)
Figure U-9	Touchdown zone	0.5 to 1.0	(white light)
Figure U-10	Runway centre line (longitudinal spacing 30 m)	0.5 to 1.0	(white light)
Figure U-11	Runway centre line (longitudinal spacing 15 m)	0.5 to 1.0 for CAT III	(white light)
		0.25 to 0.5 for CAT I, II	(white light)
Figure U-12	Runway end	0.25 to 0.5	(red light)

Figure U-13	Runway edge (45 m runway width)	1.0	(white light)
Figure U-14	Runway edge (60 m runway width)	1.0	(white light)

- (e) The beam coverages in the Figures provide the necessary guidance for approaches down to an RVR of the order of 150 m and take-offs down to an RVR of the order of 100 m.
- (f) Horizontal angles are measured with respect to the vertical plane through the runway centre line. For lights other than centre line lights, the direction towards the runway centre line is considered positive. Vertical angles are measured with respect to the horizontal plane.
- (g) Where, for approach centre line lights and crossbars and for approach side row lights, inset lights are used in lieu of elevated lights, e.g. on a runway with a displaced threshold, the intensity requirements can be met by installing two or three fittings (lower intensity) at each position.
- (h) The importance of adequate maintenance cannot be overemphasised. The average intensity should never fall to a value less than 50 % of the value shown in the Figures, and it should be the aim of aerodrome operator to maintain a level of light output close to the specified minimum average intensity.
- (i) The light unit should be installed so that the main beam is aligned within one-half degree of the specified.



**Figure U-16. Isocandela diagram for taxiway centre line (15 m spacing), RELs, no-entry bar, and stop bar lights in straight sections intended for use in runway visual range conditions of less than a value of 350 m where large offsets can occur and for low-intensity runway guard lights, Configuration B**

Notes:

- (a) These beam coverages allow for displacement of the cockpit from the centre line up to distances of the order of 12 m and are intended for use before and after curves.
- (b) See collective notes for Figures U-16 to U-25.
- (c) Increased intensities for enhanced rapid exit taxiway centre line lights are four times the respective intensities in the figure (i.e. 800 cd for minimum average main beam).

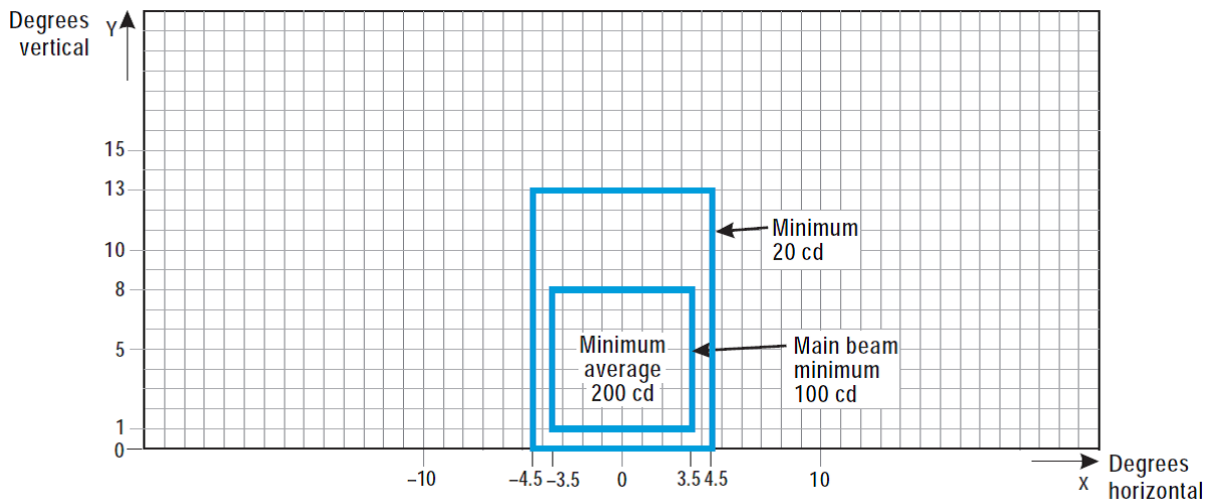


Figure U-17. Isocandela diagram for taxiway centre line (15 m spacing), no-entry bar, and stop bar lights in straight sections intended for use in runway visual range conditions of less than a value of 350 m

Notes:

- (a) These beam coverages are generally satisfactory and cater for a normal displacement of the cockpit from the centre line of approximately 3 m.
- (b) See collective notes for Figures U-16 to U-25.

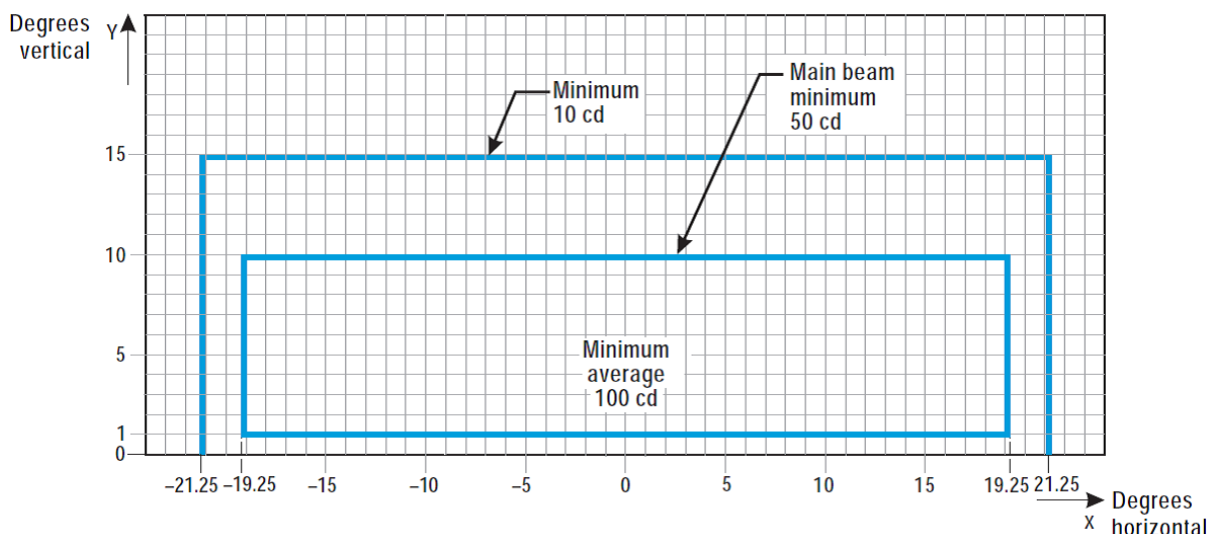


Figure U-18. Isocandela diagram for taxiway centre line (7.5 m spacing), RELs, no-entry bar, and stop bar lights in curved sections intended for use in runway visual range conditions of less than a value of 350 m

Notes:

- (a) Lights on curves to be toed-in 15.75 degrees with respect to the tangent of the curve. This does not apply to RELs.
- (b) Where provided, increased intensities for RELs should be twice the specified intensities, i.e. minimum 20 cd, main beam minimum 100 cd, and minimum average 200 cd.
- (c) See collective notes for Figures U-16 to U-25.

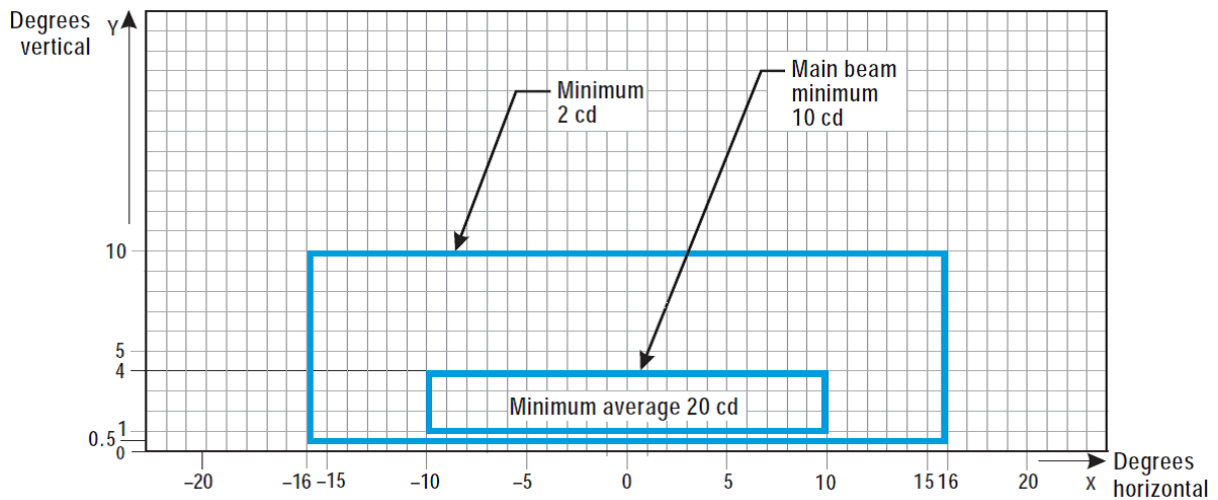


Figure U-19. Isocandela diagram for taxiway centre line (30 m, 60 m spacing), no-entry bar, and stop bar lights in straight sections intended for use in runway visual range conditions of 350 m or greater

Notes:

- At locations where high background luminance is usual, and where deterioration of light output resulting from dust, snow, and local contamination is a significant factor, the cd-values should be multiplied by 2.5.
- Where omnidirectional lights are used they should comply with the vertical beam requirements in this Figure.
- See collective notes for Figures U-16 to U-25.

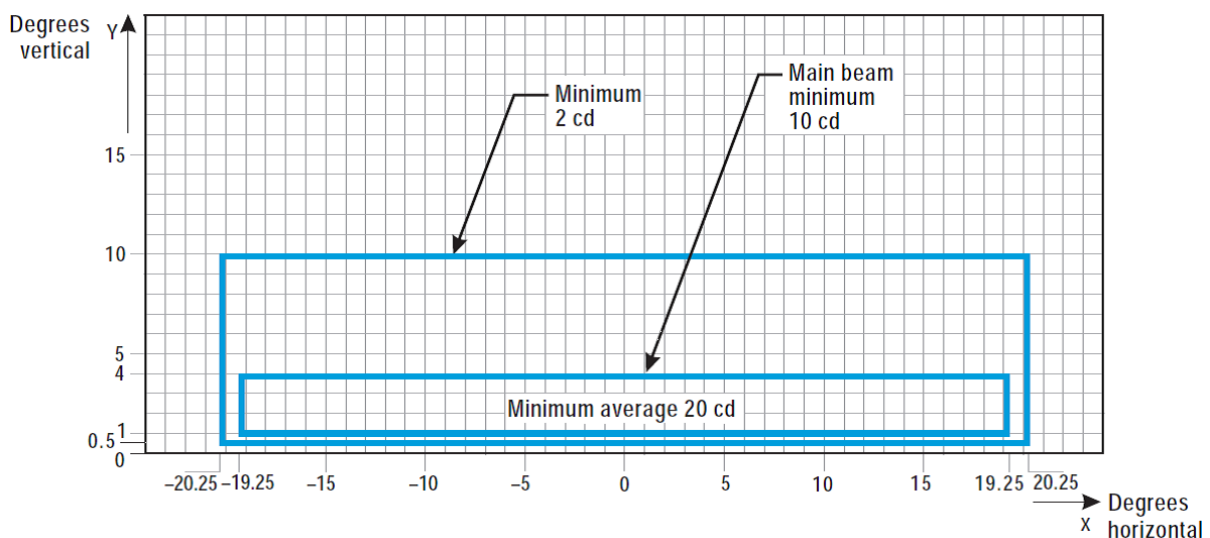
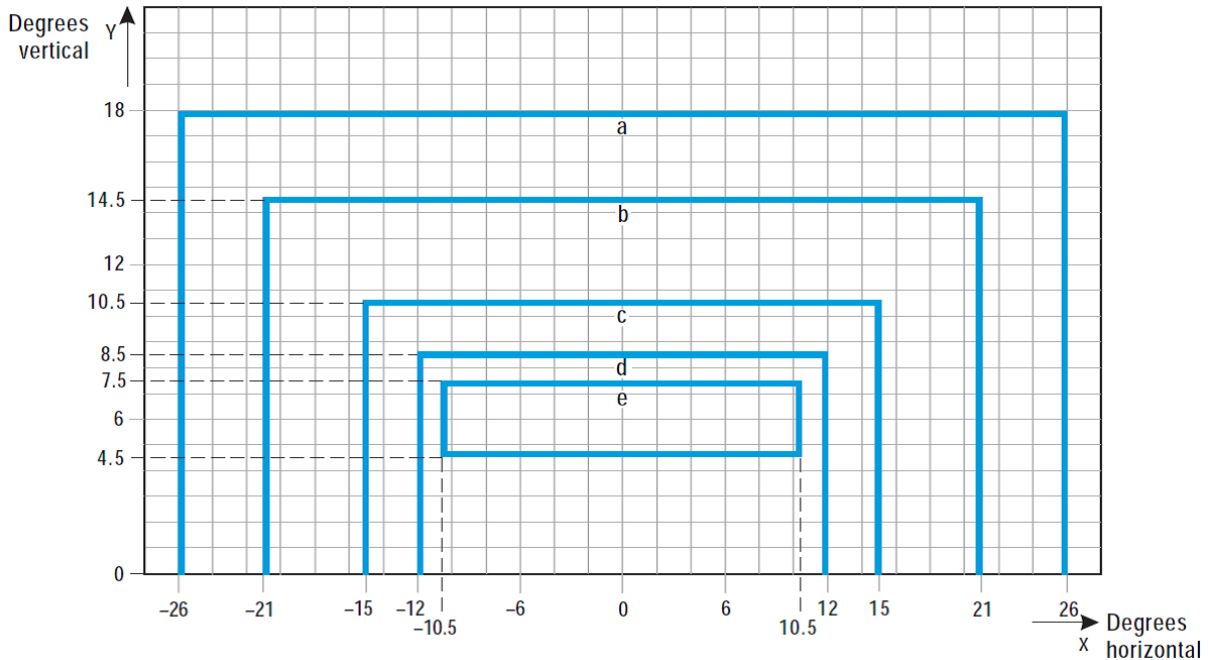


Figure U-20. Isocandela diagram for taxiway centre line (7.5 m, 15 m, 30 m spacing), no-entry bar, and stop bar lights in curved sections intended for use in runway visual range conditions of 350 m or greater

Notes:

- Lights on curves to be toed-in 15.75 degrees with respect to the tangent of the curve.
- At locations where high background luminance is usual and where deterioration of light output resulting from dust, snow and, local contamination is a significant factor, the cd-values should be multiplied by 2.5.

- (c) These beam coverages allow for displacement of the cockpit from the centre line up to distances of the order of 12 m as could occur at the end of curves.
- (d) See collective notes for Figures U-16 to U-25.



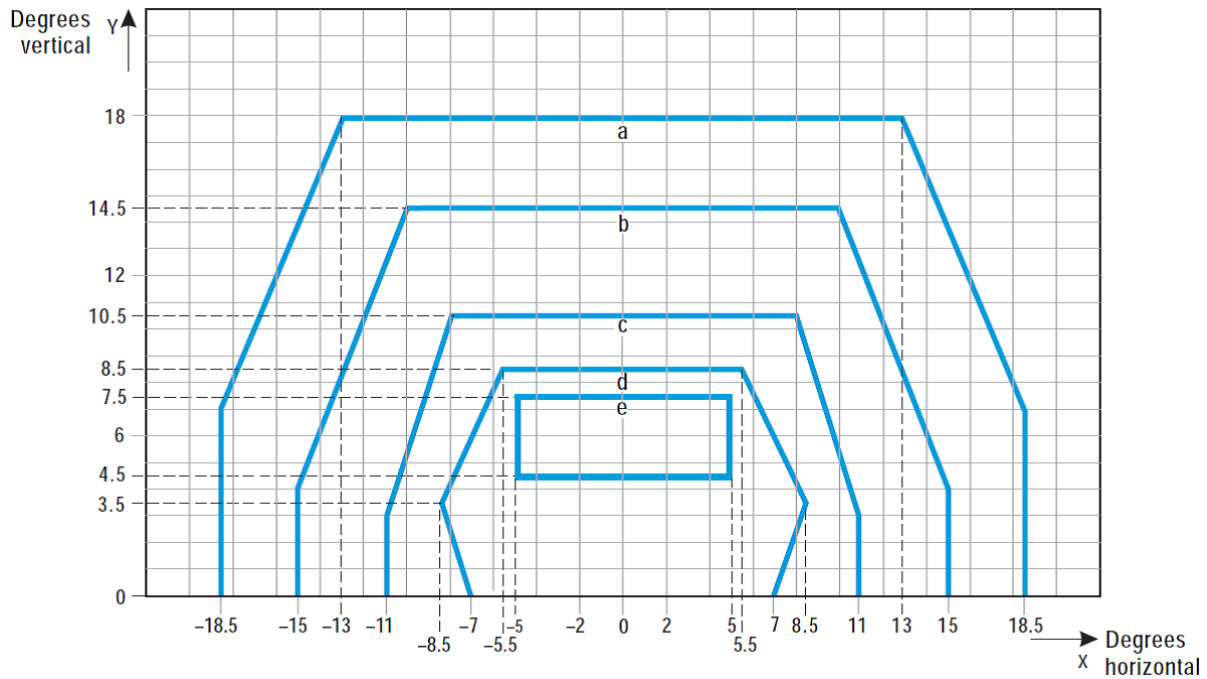
Curve	a	b	c	d	e
Intensity (cd)	8	20	100	450	1800

**Figure U-21. Isocandela diagram for high-intensity taxiway centre line (15 m spacing), no-entry bar, and stop bar lights in straight sections intended for use in an advanced surface movement guidance and control system where higher light intensities are required and where large offsets can occur.**

Notes:

- (a) These beam coverages are generally satisfactory and cater for a normal displacement of the cockpit corresponding to the outer main gear wheel on the taxiway edge.
- (b) See collective notes for Figures U-16 to U-25.



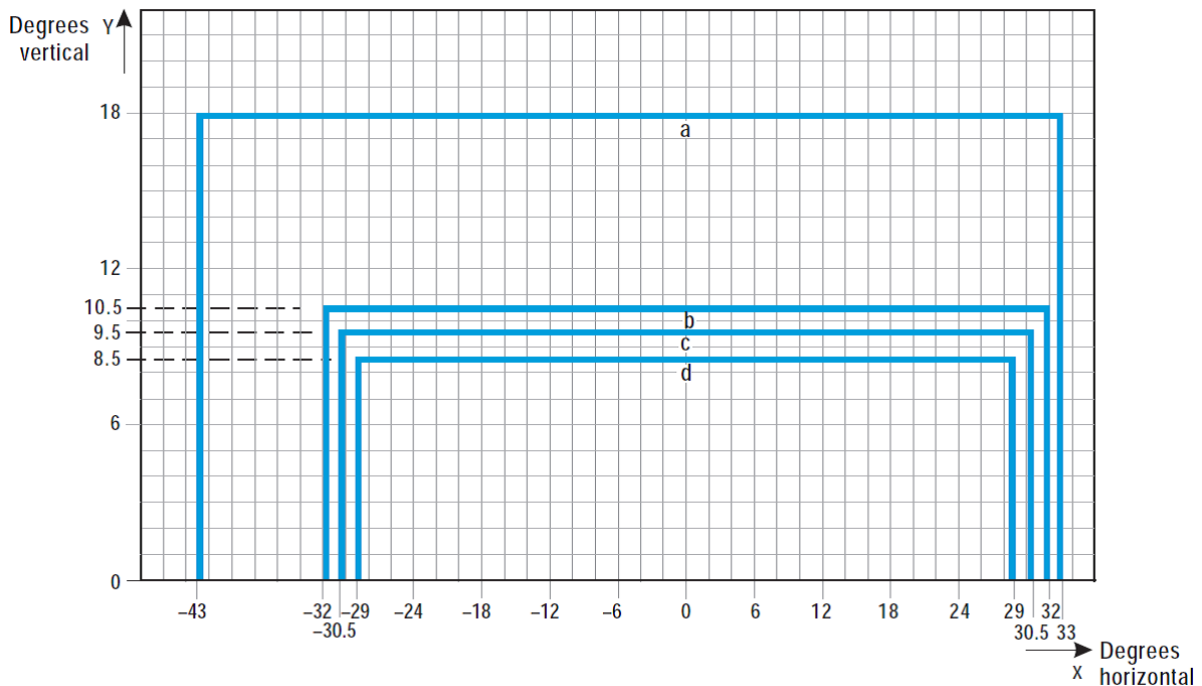


Curve	a	b	c	d	e
Intensity (cd)	8	20	100	450	1800

**Figure U-22. Isocandela diagram for high-intensity taxiway centre line (15 m spacing), no-entry bar, and stop bar lights in straight sections intended for use in an advanced surface movement guidance and control system where higher light intensities are required**

**Notes:**

- (a) These beam coverages are generally satisfactory and cater for a normal displacement of the cockpit corresponding to the outer main gear wheel on the taxiway edge.
- (b) See collective notes for Figures U-16 to U-25.



Curve	a	b	c	d
Intensity (cd)	8	100	200	400

Figure U-23. Isocandela diagram for high-intensity taxiway centre line (7.5 m spacing), no-entry bar, and stop bar lights in curved sections intended for use in an advanced surface movement guidance and control system where higher light intensities are required

Notes:

- (a) Lights on curves to be toed-in 17 degrees with respect to the tangent of the curve.
- (b) See collective notes for Figures U-16 to U-25.

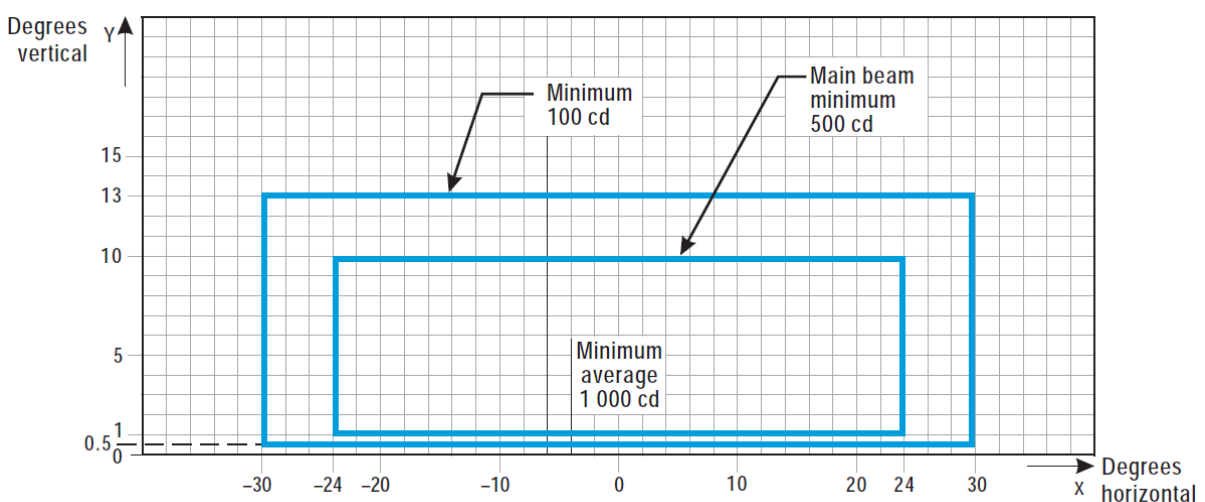
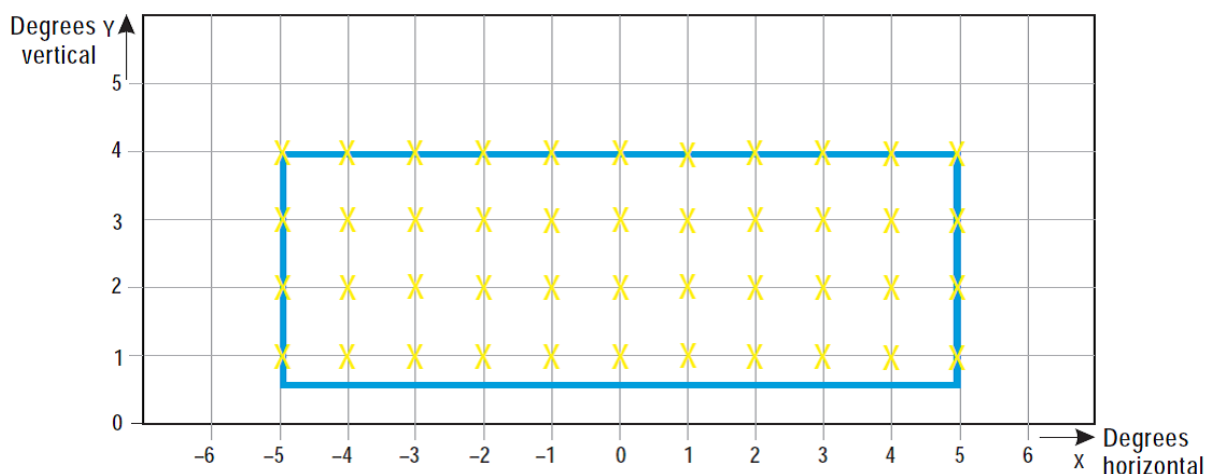


Figure U-24. Isocandela diagram for high-intensity runway guard lights, Configuration B

**Notes:**

- (a) Although the lights flash in normal operation, the light intensity is specified as if the lights were fixed for incandescent lamps.
- (b) See collective notes for Figures U-16 to U-25.



**Figure U-25. Grid points to be used for calculation of average intensity of taxiway centre line and stop bar lights**

**Collective notes to Figures U-16 to U-25:**

- (a) The intensities specified in Figures U-16 to U-24 are in green and yellow light for taxiway centre line lights, yellow light for runway guard lights, and red light for stop bar lights.
- (b) Figures U-16 to U-24 show the minimum allowable light intensities. The average intensity of the main beam is calculated by establishing grid points as shown in Figure U-25, and using the intensity values measured at all grid points located within and on the perimeter of the rectangle representing the main beam. The average value is the arithmetic average of the light intensities measured at all considered grid points.
- (c) No deviations are acceptable in the main beam or in the innermost beam as applicable, when the lighting fixture is properly aimed.
- (d) Horizontal angles are measured with respect to the vertical plane through the taxiway centre line, except on curves where they are measured with respect to the tangent to the curve.
- (e) Vertical angles are measured from the longitudinal slope of the taxiway surface.
- (f) The importance of adequate maintenance cannot be overemphasised. The intensity, either average where applicable or as specified on the corresponding isocandela curves, should never fall to a value less than 50 % of the value shown in the figures, and it should be the aim of aerodrome operator to maintain a level of light output close to the specified minimum average intensity.
- (g) The light unit should be installed so that the main beam or the innermost beam as applicable, is aligned within one-half degree of the specified requirement.

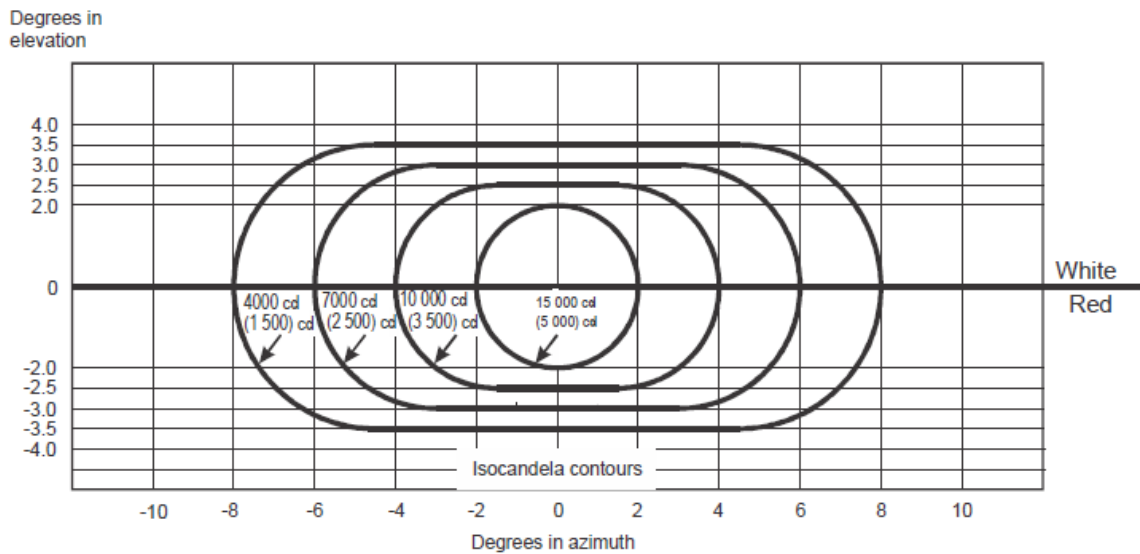


Figure U-26. Light intensity distribution of PAPI and APAPI

Notes:

- (a) These curves are for minimum intensities in red light.
- (b) The intensity value in the white sector of the beam is no less than 2 and may be as high as 6.5 times the corresponding intensity in the red sector.
- (c) The intensity values shown in brackets are for APAPI.

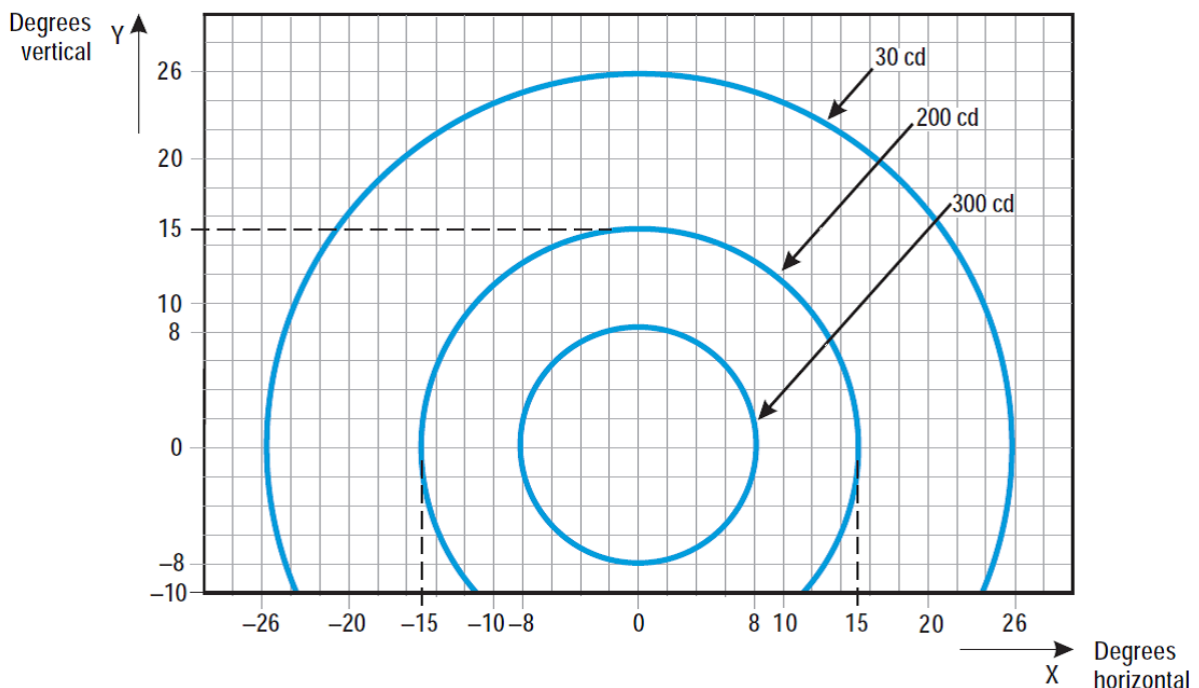


Figure U-27. Isocandela diagram for each light in low-intensity runway guard lights, Configuration A

Notes:

- (a) Although the lights flash in normal operation, the light intensity is specified as if the lights were fixed for incandescent lamps.

(b) The intensities specified are in yellow light.

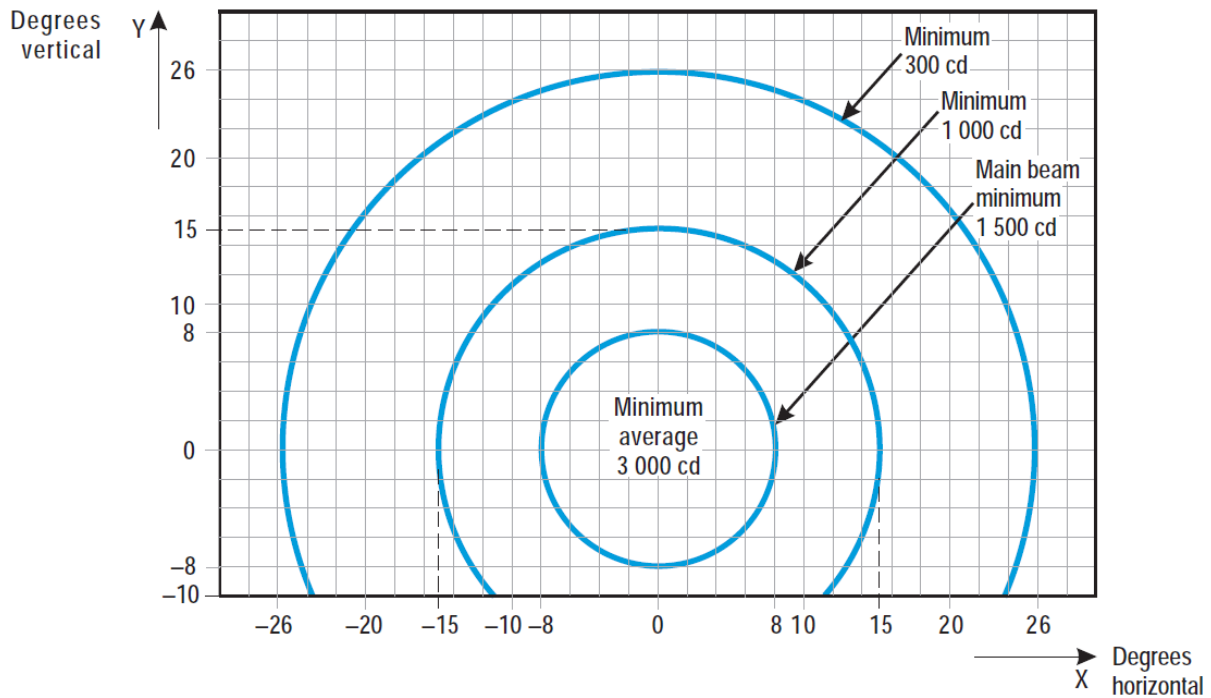


Figure U-28. Isocandela diagram for each light in high-intensity runway guard lights, Configuration A

Notes:

- (a) Although the lights flash in normal operation, the light intensity is specified as if the lights were fixed for incandescent lamps.
- (b) The intensities specified are in yellow light.

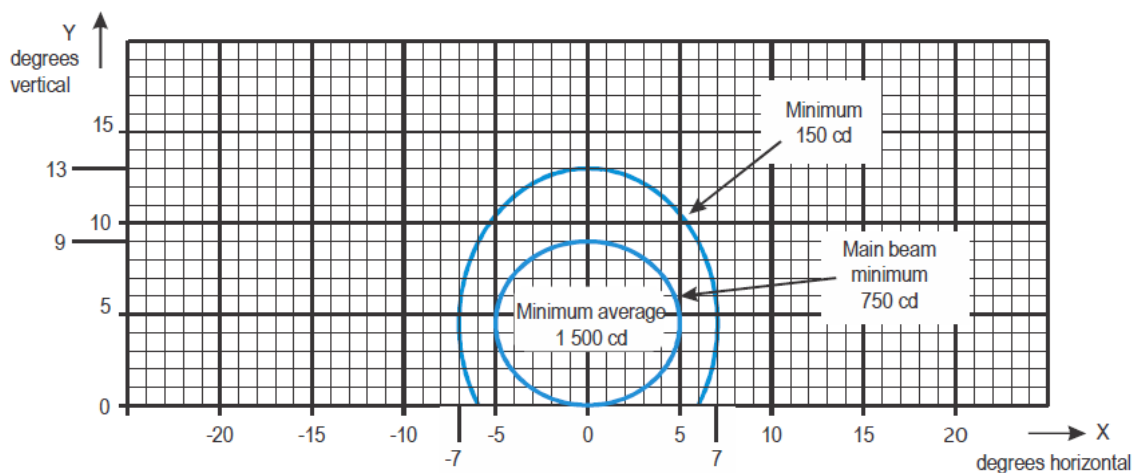


Figure U-29. Isocandela diagram for take-off and hold lights (THL) (red light)

Notes:

- (a) Curves calculated on formula

$$\frac{x^2}{a^2} + \frac{y^2}{b^2} = 1$$

a	5.0	7.0
b	4.5	8.5

---

(b) See collective notes for Figures U-5 to U-15 and Figure U-29

[Issue: ADR-DSN/3]

[Issue: ADR-DSN/4]

## **GM1 ADR-DSN.U.940 Aeronautical ground light characteristics**

*ED Decision 2014/013/R*

intentionally left blank

# CS-HPT-DSN — ISSUE 1

## LIST OF ABBREVIATIONS

*ED Decision 2019/012/R*

(used in CS-HPT-DSN)

ASPSL	arrays of segmented point source lighting
APAPI	abbreviated precision approach path indicator
CS-ADR-DSN	certification specifications for aerodromes design
FATO	final approach and take-off area
HAPI	helicopter approach path indicator
HFM	helicopter (aircraft) flight manual
LDAH	landing distance available (helicopters)
LP	luminescent panel
MTOM	maximum take-off mass
PAPI	precision approach path indicator
RTODAH	rejected take-off distance available (helicopters)
TLOF	touchdown and lift-off area
TODAH	take-off distance available (helicopters)
UCW	undercarriage width

## CHAPTER A — GENERAL

### CS HPT-DSN.A.010 Applicability

ED Decision 2019/012/R

- (a) The certification specifications (CSs) and the related guidance material (GM) (CS-HPT-DSN) are applicable to the design of surface-level VFR heliports or parts thereof located at aerodromes that fall under the scope of Regulation (EU) 2018/1139.
- (b) Where relevant, the CSs and GM for aerodrome design (CS-ADR-DSN) apply to the aerodrome areas and infrastructure used by helicopters.
- (c) Unless otherwise specified, the specifications for a colour referred to within CS-HPT-DSN should be those contained in CS-ADR-DSN.

### GM1 HPT-DSN.A.010 Applicability

ED Decision 2019/012/R

The CSs and the related GM are applicable to the design of surface-level VFR heliports, including those that are not open for public use or for commercial air transport, which are located at aerodromes that fall under the scope of Regulation (EU) 2018/1139.

### CS HPT-DSN.A.020 Definitions

ED Decision 2019/012/R

For the purposes of CS-HPT-DSN, the following definitions should apply:

‘D’ means the largest overall dimension of the helicopter when rotor(s) are turning measured from the most forward position of the main rotor tip path plane to the most rearward position of the tail rotor tip path plane or helicopter structure.

Note: ‘D’ is sometimes referred to in the text using the term ‘D-value’.

‘Declared distances’ — heliports means:

- Take-off distance available (TODAH). The length of the FATO plus the length of helicopter clearway (if provided) declared available and suitable for helicopters to complete the take-off.
- Rejected take-off distance available (RTODAH). The length of the FATO declared available and suitable for helicopters operated in performance class 1 to complete a rejected take-off.
- Landing distance available (LDAH). The length of the FATO plus any additional area declared available and suitable for helicopters to complete the landing manoeuvre from a defined height.

‘Dynamic load-bearing surface’ means a surface capable of supporting the loads generated by a helicopter conducting an emergency touchdown on it.

‘Final approach and take-off area (FATO)’ means a defined area over which the final phase of the approach manoeuvre to hover or landing is completed and from which the take-off manoeuvre is commenced. Where the FATO is to be used by helicopters operated in performance class 1, the defined area includes the rejected take-off area available.

‘Helicopter air taxiway’ means a defined path on the surface established for the air taxiing of helicopters.



‘Helicopter clearway’ means a defined area on the ground or water, selected and/or prepared as a suitable area over which a helicopter operated in performance class 1 may accelerate and achieve a specific height.

‘Helicopter ground taxiway’ means a ground taxiway intended for the ground movement of wheeled undercarriage helicopters.

‘Helicopter stand’ means an aircraft stand which provides for parking a helicopter and where ground taxi operations are completed or where the helicopter touches down and lifts off for air taxi operations.

‘Helicopter taxi-route’ means a defined path established for the movement of helicopters from one part of a heliport to another. A taxi-route includes a helicopter air or ground taxiway which is centred on the taxi-route.

‘Heliport’ means an aerodrome or a defined area on a structure intended to be used wholly or in part for the arrival, departure and surface movement of helicopters.

‘Heliport elevation’ means the elevation of the highest point of the FATO.

‘Protection area’ means an area within a taxi-route and around a helicopter stand which provides separation from objects, the FATO, other taxi-routes and helicopter stands, for safe manoeuvring of helicopters.

‘Rejected take-off area’ means a defined area on a heliport suitable for helicopters operating in performance class 1 to complete a rejected take-off.

‘Runway-type FATO’ means a FATO having characteristics similar in shape to a runway.

‘Safety area’ means a defined area on a heliport surrounding the FATO which is free of obstacles, other than those required for air navigation purposes, and intended to reduce the risk of damage to helicopters accidentally diverging from the FATO.

‘Static load-bearing surface’ means a surface capable of supporting the mass of a helicopter situated on it.

‘Surface-level heliport’ means a heliport located on the ground or on a structure on the surface of the water.

‘Touchdown and lift-off area (TLOF)’ means an area on which a helicopter may touch down or lift off.

Note: The above-mentioned definitions are in addition to those listed in CS-ADR-DSN.

## **GM1 HPT-DSN.A.020 Definitions**

*ED Decision 2019/012/R*

Further information on operations of performance classes 1, 2 and 3 helicopters are given in Commission Regulation (EU) No 965/2012 on air operations and in ICAO Annex 6, Operations of Aircraft, Part III, Helicopters.

## CHAPTER B — HELICOPTER OPERATING AREAS

### CS HPT-DSN.B.100 Final approach and take-off areas (FATOs)

ED Decision 2019/012/R

- (a) Applicability: A heliport should be provided with at least one final approach and take-off area (FATO).
- (b) Location: A FATO in proximity to other infrastructure and objects should be located so as to minimise:
  - (1) the influence of the surrounding environment, including structure-induced turbulence;
  - (2) the influence of, and on, the surrounding traffic, including wake turbulence, where simultaneous aircraft operations are intended.
- (c) Characteristics:
  - (1) A FATO should be obstacle-free; however, when collocated with the touchdown and lift-off area (TLOF), TLOF arrays of segmented point source lighting (ASPSL) or luminescent panels (LPs) with a height not more than 5 cm can be provided for the installation of visual aids.
  - (2) Where a FATO is intended to be used by helicopters operated in performance class 1, its dimensions should be as prescribed in the helicopter (aircraft) flight manual (HFM) except that, in the absence of width specifications, the width should be not less than the greatest overall dimension (D) of the largest helicopter the FATO is intended to serve.
  - (3) Where a FATO is intended to be used by helicopters operated in performance class 2 or 3, its dimensions should be of sufficient size and shape to contain an area within which a circle can be drawn of diameter not less than:
    - (i) 1 D of the largest helicopter when the maximum take-off mass (MTOM) of helicopters the FATO is intended to serve is more than 3 175 kg;
    - (ii) 0.83 D of the largest helicopter when the MTOM of helicopters the FATO is intended to serve is 3 175 kg or less.
  - (4) The surface of the FATO should:
    - (i) be resistant to the effects of rotor downwash;
    - (ii) be free of irregularities that would adversely affect the take-off or landing of helicopters;
    - (iii) have bearing strength sufficient to accommodate a rejected take-off by helicopters operated in performance class 1;
    - (iv) provide ground effect;
    - (v) have a mean slope in any direction which should not exceed 3 per cent; and
    - (vi) provide rapid drainage.
  - (5) No portion of a FATO should have a local slope exceeding:
    - (i) 5 per cent where the heliport is intended to be used by helicopters operated in performance class 1;

- (ii) 7 per cent where the heliport is intended to be used by helicopters operated in performance class 2 or 3.

## GM1 HPT-DSN.B.100 Final approach and take-off areas (FATOs)

*ED Decision 2019/012/R*

(a) General:

- (1) A FATO may not be necessary to be provided at an aerodrome, where the runway is used for the purposes of final approach and take-off of helicopters.
- (2) Where a FATO is located near a runway or taxiway, and when simultaneous helicopter and aeroplane operations are planned, the separation distance between the edge of a runway or taxiway and the edge of a FATO should not be less than the appropriate dimension in Table GM1-B-1.
- (3) Operational limitations should be considered under certain wind conditions.

If aeroplane mass and/or helicopter mass are	Distance between FATO edge and runway edge or taxiway edge
up to but not including 3 175 kg	60 m
3 175 kg up to but not including 5 760 kg	120 m
5 760 kg up to but not including 100 000 kg	180 m
100 000 kg and over	250 m

Note: The values specified in this table are primarily intended to mitigate risks of wake turbulence encounters. In addition to this table, when positioning a FATO intended to be used simultaneously with a nearby runway or taxiway, attention should be given to other CS ADR-DSN requirements such as the minimum runway strip width. Local environment should be taken into account when setting the separation between the FATO and nearby infrastructure elements to ensure the safety of simultaneous operations.

**Table GM1-B-1. FATO minimum separation distance**

(b) A FATO should not be located:

- (i) near taxiway intersections or holding points where jet engine efflux is likely to cause high turbulence; or
- (ii) near areas where aeroplane vortex wake generation is likely to occur.

## CS HPT-DSN.B.110 Helicopter clearways

*ED Decision 2019/012/R*

(a) Applicability: When provided, a helicopter clearway should be located beyond the end of the FATO.

(b) Characteristics:

- (1) The width of a helicopter clearway should not be less than that of the associated safety area (see Figure B-1).
- (2) The ground in a helicopter clearway should not project above a plane having an upward slope of 3 per cent, commencing at the periphery of the FATO.
- (3) An object situated in a helicopter clearway, which may endanger helicopters in the air, should be regarded as an obstacle and should be removed.

## GM1 HPT-DSN.B.110 Helicopter clearways

ED Decision 2019/012/R

General: A helicopter clearway would need to be considered when the heliport is intended to be used by helicopters operating in performance class 1.

## CS HPT-DSN.B.120 Touchdown and lift-off areas (TLOFs)

ED Decision 2019/012/R

- (a) General:
- (1) At least one TLOF should be provided at a heliport.
  - (2) One TLOF should be located within the FATO or one or more TLOFs should be collocated with helicopter stands.
- (b) Characteristics:
- (1) A TLOF should be of sufficient size to contain a circle of diameter of at least 0.83 D of the largest helicopter the area is intended to serve.
  - (2) Where the TLOF is within the FATO, the TLOF should be dynamic load-bearing.
  - (3) Where a TLOF is collocated with a helicopter stand, the TLOF should be static load-bearing and be capable of withstanding the traffic of the helicopters that the area is intended to serve.
  - (4) Slopes on a TLOF should be sufficient to prevent accumulation of water on the surface of the area and should not exceed 2 per cent in any direction.
  - (5) Where a TLOF is located within a FATO which can contain a circle of diameter more than 1 D, the centre of the TLOF should be located not less than 0.5 D from the edge of the FATO.

## GM1 HPT-DSN.B.120 Touchdown and lift-off areas (TLOFs)

ED Decision 2019/012/R

Additional TLOFs may be located within runway-type FATOs.

## CS HPT-DSN.B.130 Safety areas

ED Decision 2019/012/R

- (a) General: A FATO should be surrounded by a safety area which need not be solid.
- (b) Characteristics:
- (1) A safety area surrounding a FATO should extend outwards from the periphery of the FATO for a distance of at least 3 m or 0.25 D, whichever is greater, of the largest helicopter the FATO is intended to serve and:
    - (i) each external side of the safety area should be at least 2 D where the FATO is quadrilateral (see Figure B-1); or
    - (ii) the outer diameter of the safety area should be at least 2 D where the FATO is circular.

- (2) The surface of the safety area should be treated to prevent flying debris caused by rotor downwash.
- (3) When solid, the surface of the safety area abutting the FATO should be continuous with the FATO.
- (4) When solid, the surface of a safety area should not project above a plane having an upward slope of 4 per cent, commencing at the periphery of the FATO.
- (5) From the outer edge of the safety area to a distance of 10 m there should be a protected side slope rising at 45 degrees.
- (6) The protected side slope should not be penetrated by obstacles, except that when obstacles are located to one side of the FATO only, they may be permitted to penetrate the side slope surface.
- (7) No mobile object should be permitted on a safety area during helicopter operations.
- (8) No fixed object should be permitted above the plane of the FATO on a safety area, except for frangible objects which, because of their function, must be located on the area.
- (9) Objects whose function requires them to be located on the safety area should not:
  - (i) if located at a distance of less than 0.75 D from the centre of the FATO, penetrate a plane at a height of 5 cm above the plane of the FATO; and
  - (ii) if located at a distance of 0.75 D or more from the centre of the FATO, penetrate a plane originating at a height of 25 cm above the plane of the FATO and sloping upwards and outwards at a gradient of 5 per cent.

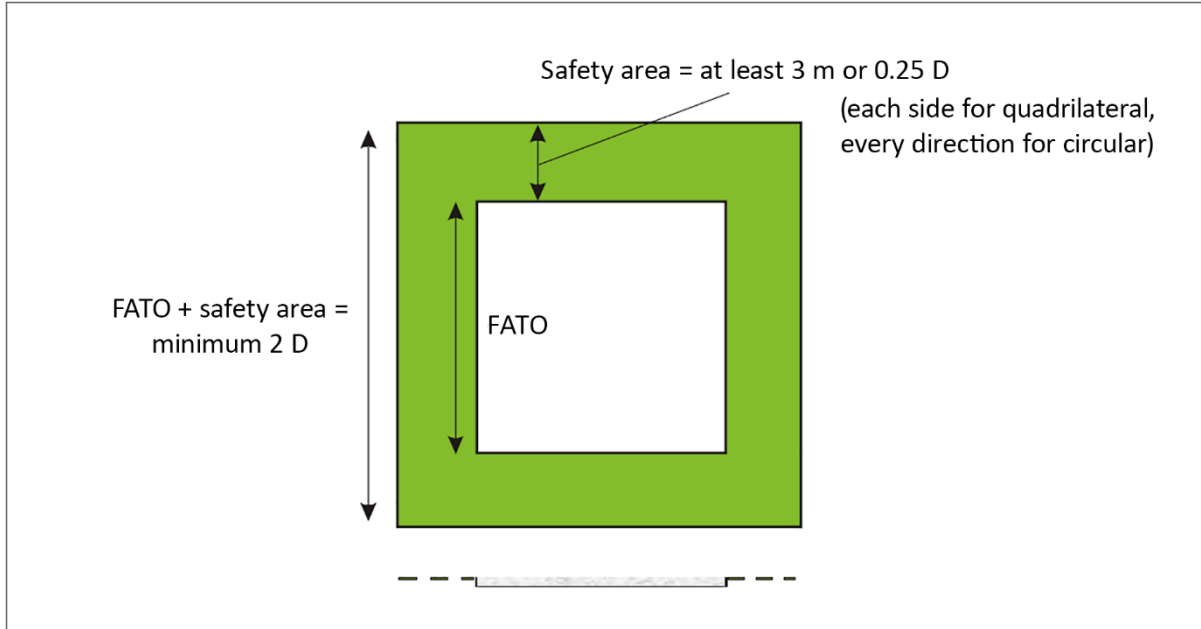


Figure B-1. FATO and associated safety area

## GM1 HPT-DSN.B.130 Safety areas

ED Decision 2019/012/R

When only a single approach and take-off climb surface is provided, the need for specific protected side slopes should be determined by a safety assessment.

## CHAPTER C — HELICOPTER TAXIWAYS AND TAXI-ROUTES

### CS HPT-DSN.C.200 Helicopter ground taxiways and helicopter ground taxi-routes

*ED Decision 2019/012/R*

- (a) General: A helicopter ground taxiway should be designed to permit the surface movement of a wheeled helicopter under its own power.
- (b) Characteristics:
  - (1) The width of a helicopter ground taxiway should not be less than 1.5 times the largest width of the undercarriage (UCW) of the helicopters the helicopter ground taxiway is intended to serve (see Figure C-1).
  - (2) The longitudinal slope of a helicopter ground taxiway should not exceed 3 per cent.
  - (3) A helicopter ground taxiway should be static load-bearing and capable of withstanding the traffic of the helicopters the helicopter ground taxiway is intended to serve.
  - (4) A helicopter ground taxiway should be centred on a helicopter ground taxi-route.
  - (5) A helicopter ground taxi-route should extend symmetrically on each side of the centre line for at least 0.75 times the largest overall width of the helicopters it is intended to serve.
  - (6) No fixed object should be permitted above the surface on a helicopter ground taxi-route, except for frangible objects, which, because of their function, must be located there.
  - (7) No mobile object should be permitted on a ground taxi-route during helicopter movements.
  - (8) Objects whose function requires them to be located on a helicopter ground taxi-route should not:
    - (i) be located at a distance of less than 50 cm from the edge of the helicopter ground taxiway; and
    - (ii) penetrate a plane originating at a height of 25 cm above the plane of the helicopter ground taxiway, at a distance of 50 cm from the edge of the helicopter ground taxiway and sloping upwards and outwards at a gradient of 5 per cent.
  - (9) The helicopter ground taxiway and the helicopter ground taxi-route should provide rapid drainage but the transverse slope of a helicopter ground taxiway should not exceed 2 per cent.
  - (10) The surface of a helicopter ground taxi-route should be resistant to the effect of rotor downwash.
  - (11) For simultaneous operations, the helicopter ground taxi-routes should not overlap.

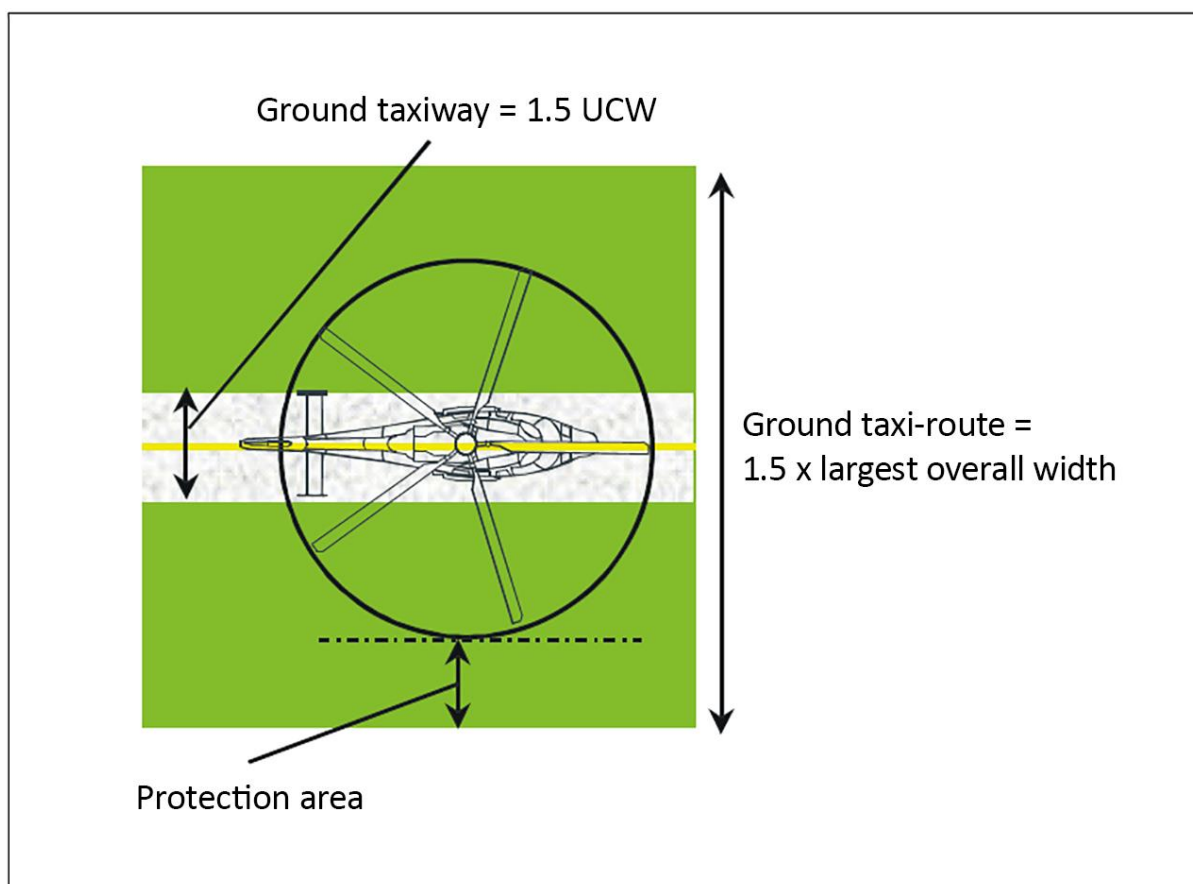


Figure C-1. Helicopter ground taxi-route/taxiway

## GM1 HPT-DSN.C.200 Helicopter ground taxiways and helicopter ground taxi-routes

ED Decision 2019/012/R

When a taxiway is intended for use by aeroplanes and helicopters, the provisions for taxiways for aeroplanes and helicopter ground taxiways will be taken into consideration and the more stringent requirements should apply.

## CS HPT-DSN.C.210 Helicopter air taxiways and helicopter air taxi-routes

ED Decision 2019/012/R

- (a) General: A helicopter air taxiway should be designed so as to permit the movement of a helicopter above the surface at a height normally associated with ground effect and at ground speed less than 37 km/h (20 kt).
- (b) Characteristics:
  - (1) The width of a helicopter air taxiway should be at least two times the largest width of the undercarriage (UCW) of the helicopters that the helicopter air taxiway is intended to serve (see Figure C-2).
  - (2) The surface of a helicopter air taxiway should be static load-bearing.

- (3) The slopes of the surface of a helicopter air taxiway should not exceed the slope landing limitations of the helicopters the helicopter air taxiway is intended to serve.
- (4) The transverse slope of a helicopter air taxiway should not exceed 10 per cent.
- (5) The longitudinal slope of a helicopter air taxiway should not exceed 7 per cent.
- (6) A helicopter air taxiway should be centred on a helicopter air taxi-route.
- (7) A helicopter air taxi-route should extend symmetrically on each side of the centre line for a distance at least equal to the largest overall width of the helicopters it is intended to serve.
- (8) No fixed object should be permitted above the surface on an air taxi-route, except for frangible objects, which, because of their function, must be located there.
- (9) No mobile object should be permitted on an air taxi-route during helicopter movements.
- (10) Objects above ground level whose function requires them to be located on a helicopter air taxi route should not:
  - (i) be located at a distance of less than 1 m from the edge of the helicopter air taxiway, or at a distance of less than 0.5 times the largest overall width of the helicopter for which the helicopter air taxi-route is designed from the centre line of the helicopter air taxiway, whichever is greater; and
  - (ii) penetrate a plane originating at a height of 25 cm above the plane of the helicopter air taxiway, and sloping upwards and outwards at a gradient of 5 per cent, at a distance of 1 m from the edge of the helicopter air taxiway, or at a distance of 0.5 times the largest overall width of the helicopter for which the helicopter air taxi-route is designed from the centreline of the helicopter air taxiway, whichever is lower.
- (11) The surface of a helicopter air taxi-route should be resistant to the effect of rotor downwash.
- (12) The surface of a helicopter air taxi-route should provide ground effect.
- (13) For simultaneous operations, the helicopter air taxi-routes should not overlap.



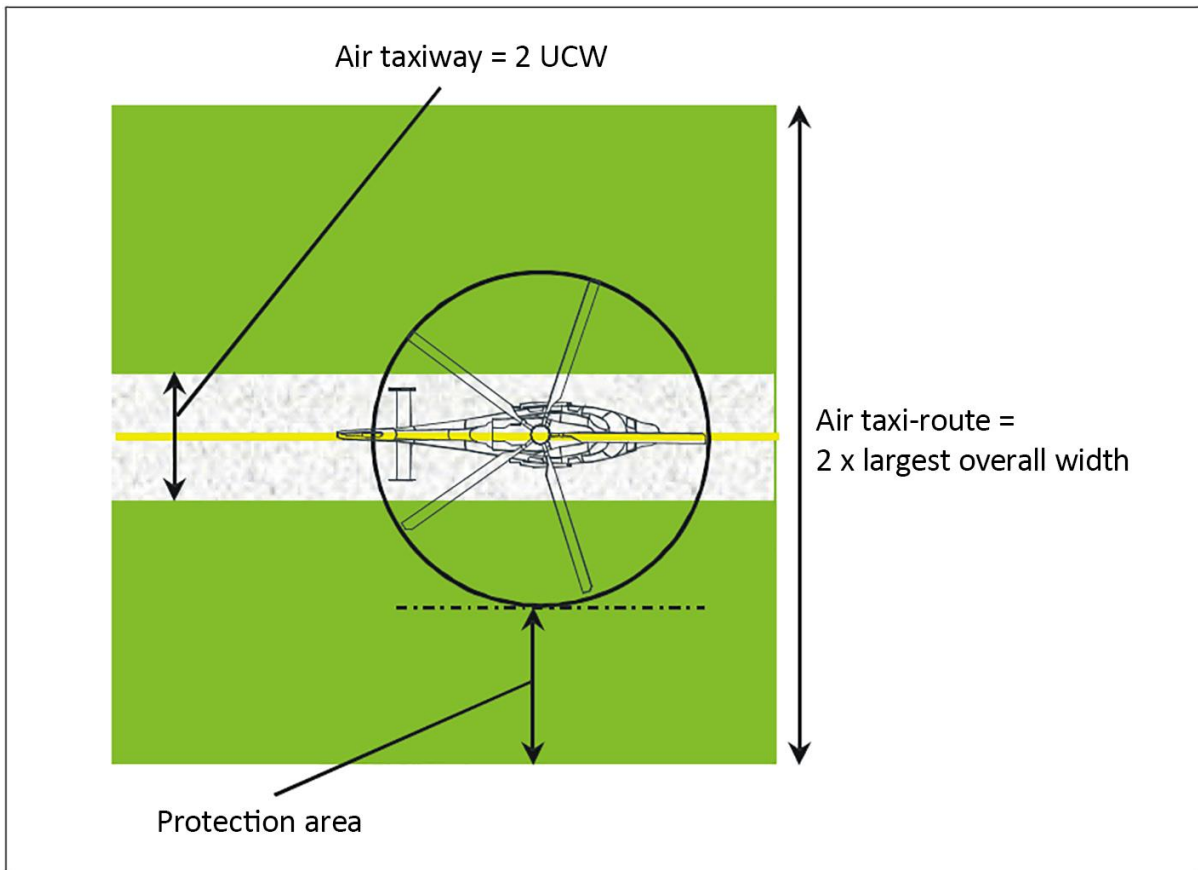


Figure C-2. Helicopter air taxi-route/taxiway

## GM1 HPT-DSN.C.210 Helicopter air taxiways and helicopter air taxi-routes

ED Decision 2019/012/R

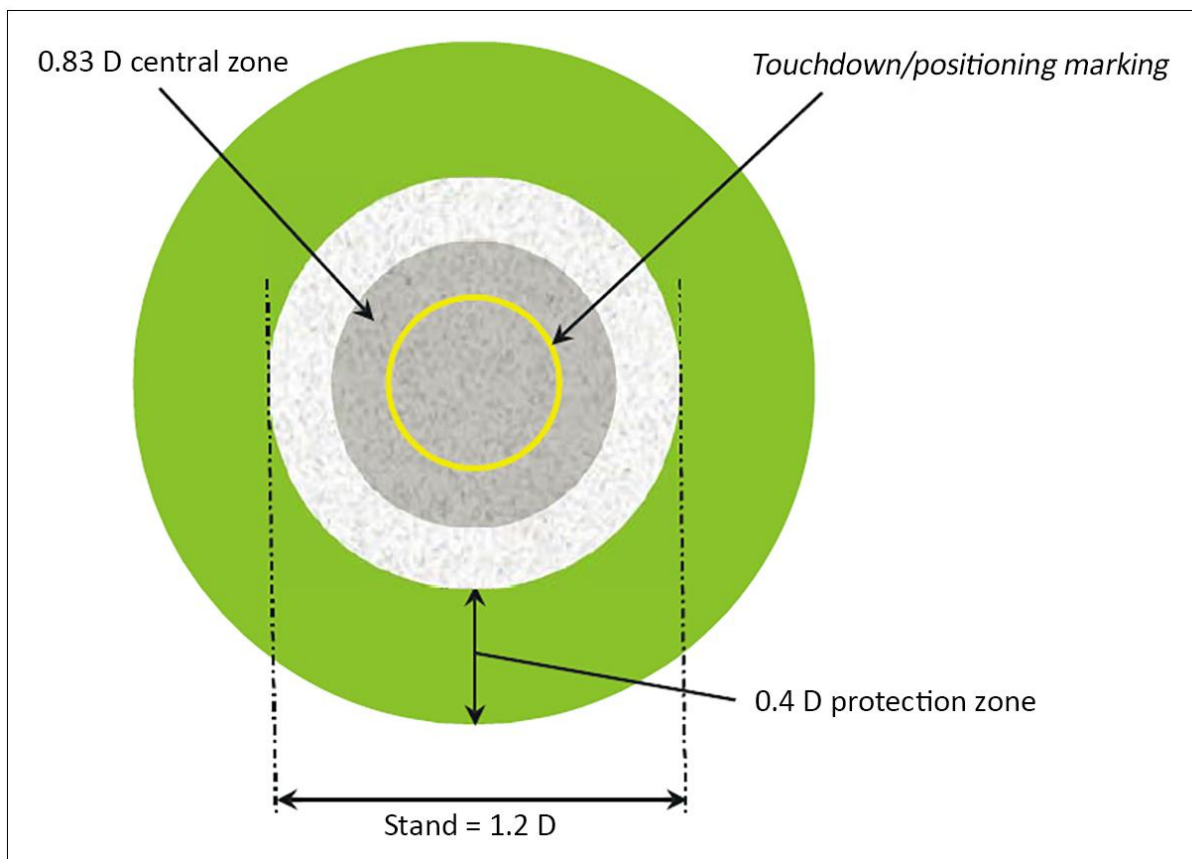
The part of the helicopter air taxi-route that extends symmetrically on each side of the centre line from 0.5 times the largest overall width of the helicopters it is intended to serve to the outermost limit of the helicopter air taxi-route is its protection area.

## CHAPTER D — HELICOPTER STANDS

### CS HPT-DSN.D.300 Helicopter stands

ED Decision 2019/012/R

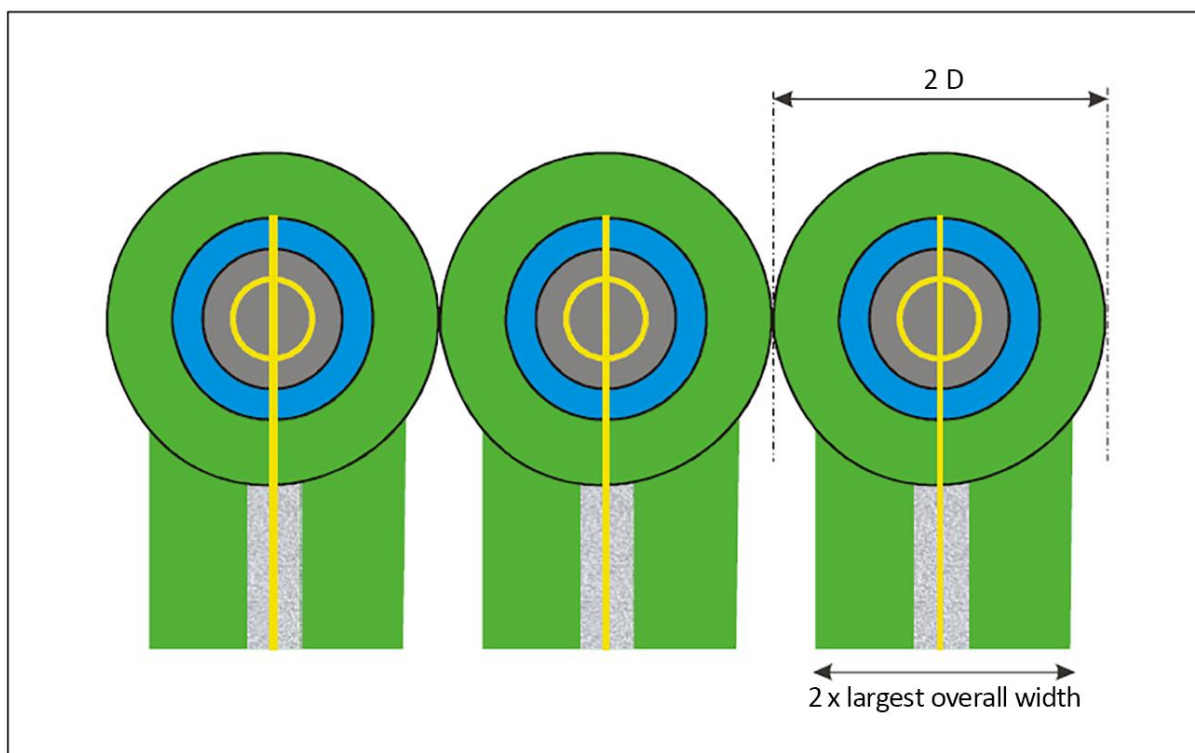
- (a) Characteristics:
- (1) When a TLOF is collocated with a helicopter stand, the protection area of the stand should not overlap the protection area of any other helicopter stand or associated taxi route.
  - (2) A helicopter stand should provide rapid drainage.
  - (3) The slope of a helicopter stand in any direction should not exceed 2 per cent.
  - (4) When used by helicopters turning in a hover, a helicopter stand should be of sufficient size to contain a circle of diameter of at least 1.2 D of the largest helicopter the stand is intended to serve (see Figure D-1).
  - (5) Where a helicopter stand is intended to be used for taxi-through and where the helicopter using the stand is not required to turn, the minimum width of the stand and associated protection area should be that of the taxi-route.
  - (6) Where a helicopter stand is intended to be used for turning, the minimum overall dimension of the stand and protection area should not be less than 2 D.
  - (7) Where a helicopter stand is intended to be used for turning, the helicopter stand should be surrounded by a protection area which extends for a distance of 0.4 D from the edge of the helicopter stand.



**Figure D-1. Helicopter stand and associated protection area permitting the helicopter to turn in a hover when operating**

- (8) For simultaneous operations, the protection areas of helicopter stands and their associated taxi-routes should not overlap (see Figure D-2).
- (9) A helicopter stand and the associated protection area intended to be used for air taxiing should provide ground effect.
- (10) No fixed object should be permitted above the surface of the ground on a helicopter stand, except for tie-down points with a height of less than 5 cm, which can be accommodated if needed.
- (11) No fixed object should be permitted above the surface of the ground in the protection area around a helicopter stand except for frangible objects which, because of their function, must be located there.
- (12) No mobile object should be permitted on a helicopter stand and the associated protection area during helicopter movements.
- (13) Objects whose function requires them to be located in the protection area at a distance of less than 0.75 D from the centre of the helicopter stand, should not exceed 5 cm in height.
- (14) Objects whose function requires them to be located in the protection area should not:
  - (i) if located at a distance of less than 0.75 D from the centre of the helicopter stand, penetrate a plane at a height of 5 cm above the plane of the central zone; and

- (ii) if located at a distance of  $0.75 D$  or more from the centre of the helicopter stand, penetrate a plane at a height of 25 cm above the plane of the central zone and sloping upwards and outwards at a gradient of 5 per cent.
- (15) The central zone of a helicopter stand should be capable of withstanding the traffic of helicopters it is intended to serve and have a static load-bearing area:
- (i) of diameter not less than  $0.83 D$  of the largest helicopter it is intended to serve; or
  - (ii) for a helicopter stand intended to be used for taxi-through, and where the helicopter using the stand is not required to turn, the same width as the helicopter ground taxiway.



**Figure D-2. Helicopter stands designed for hover turns with air taxi-routes/taxiways — simultaneous operations**

## GM1 HPT-DSN.D.300 Helicopter stands

*ED Decision 2019/012/R*

- (a) It is not considered good practice to locate helicopter stands under a flight path.
- (b) Where non-simultaneous operations are envisaged, the protection areas of helicopter stands and their associated taxi-routes may overlap (see Figure GM1-D-1).
- (c) Characteristics: For a helicopter stand intended to be used by wheeled helicopters for turning on the ground, the dimension of the helicopter stand and the protection area, including the dimension of the central zone, would need to be significantly increased.

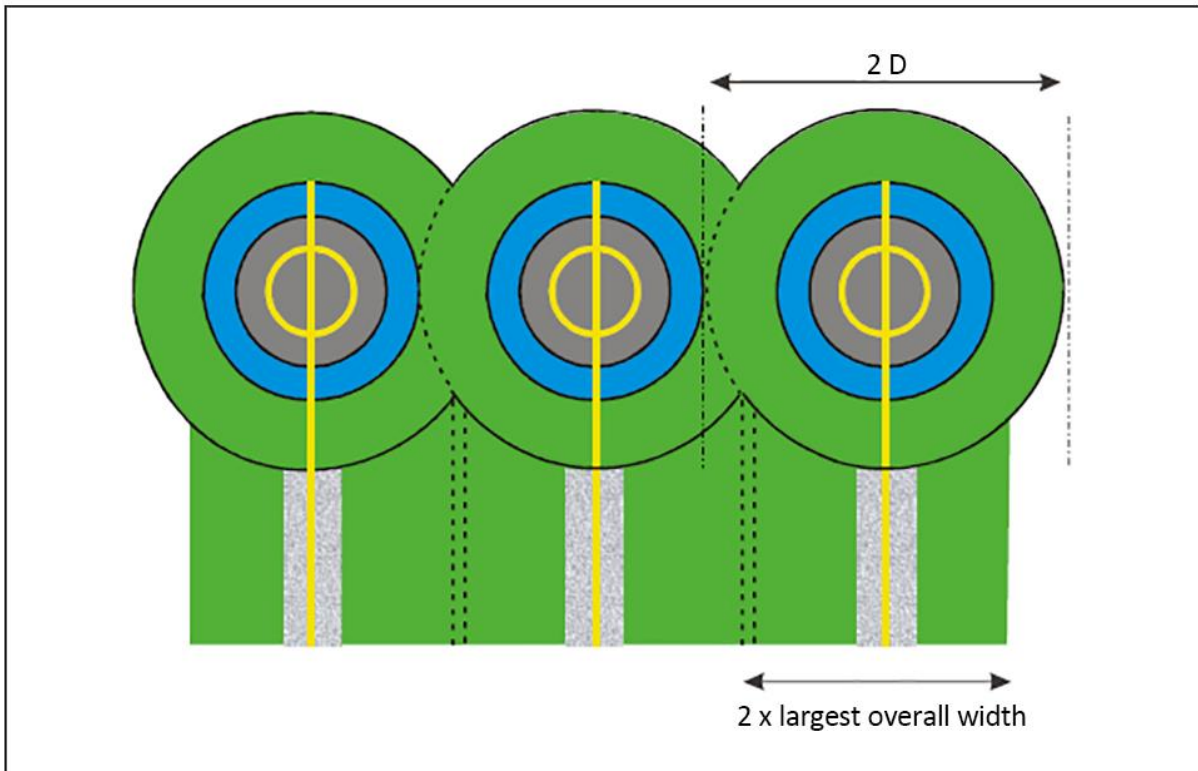


Figure GM1-D-1. Helicopter stands designed for hover turns with air taxi-routes/taxiways – non-simultaneous operations

## CHAPTER E — OBSTACLE LIMITATION SURFACES AND REQUIREMENTS

### CS HPT-DSN.E.400 Applicability

*ED Decision 2019/012/R*

The purpose of the obstacle limitation surfaces is to define the airspace around heliports so as to permit intended helicopter operations to be conducted safely.

### GM1 HPT-DSN.E.400 Applicability

*ED Decision 2019/012/R*

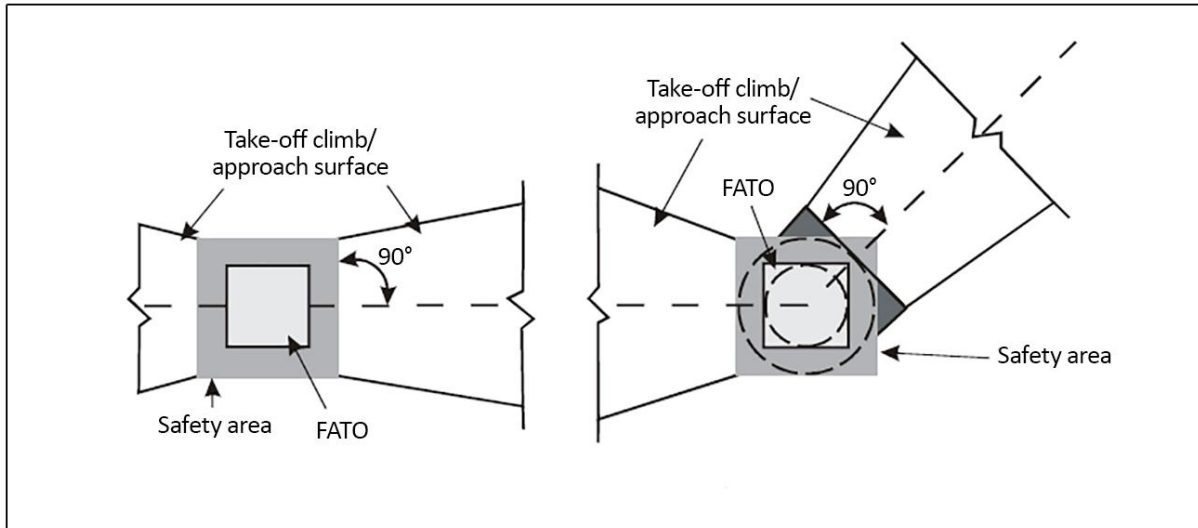
Intentionally left blank

### CS HPT-DSN.E.410 Approach surface

*ED Decision 2019/012/R*

- (a) **Applicability:** The purpose of an approach surface is to protect a helicopter during the final approach to the FATO by defining an area that should be kept free from obstacles to protect a helicopter in the final phase of the approach to land manoeuvre.
- (b) **Description:** An inclined plane or a combination of planes or, when a turn is involved, a complex surface sloping upwards from the end of the safety area and centred on a line passing through the centre of the FATO (see Figures E-1, E-2, E-3 and E-4 and Table E-1).
- (c) **Characteristics:**
  - (1) The limits of an approach surface should comprise:
    - (i) an inner edge horizontal and equal in length to the minimum specified width/diameter of the FATO plus the safety area, perpendicular to the centre line of the approach surface and located at the outer edge of the safety area;
    - (ii) two side edges originating at the ends of the inner edge diverging uniformly at a specified rate from the vertical plane containing the centre line of the FATO; and
    - (iii) an outer edge horizontal and perpendicular to the centre line of the approach surface and at a specified height of 152 m (500 ft) above the elevation of the FATO.
  - (2) The elevation of the inner edge should be the elevation of the FATO at the point on the inner edge that is intersected by the centre line of the approach surface. For heliports intended to be used by helicopters operated in performance class 1, the inclined plane may be raised directly above the FATO.
  - (3) The slope(s) of the approach surface should be measured in the vertical plane containing the centre line of the surface.
  - (4) In the case of an approach surface involving a turn, the surface should be a complex surface containing the horizontal normals to its centre line and the slope of the centre line should be the same as that for a straight approach surface (see Figure E-3).
  - (5) In the case of an approach surface involving a turn, the surface should not contain more than one curved portion.

- (6) Where a curved portion of an approach surface is provided, the sum of the radius of the arc defining the centre line of the approach surface and the length of the straight portion originating at the inner edge should not be less than 575 m.
- (7) Any variation in the direction of the centre line of an approach surface should be designed so as not to necessitate a turn radius less than 270 m.

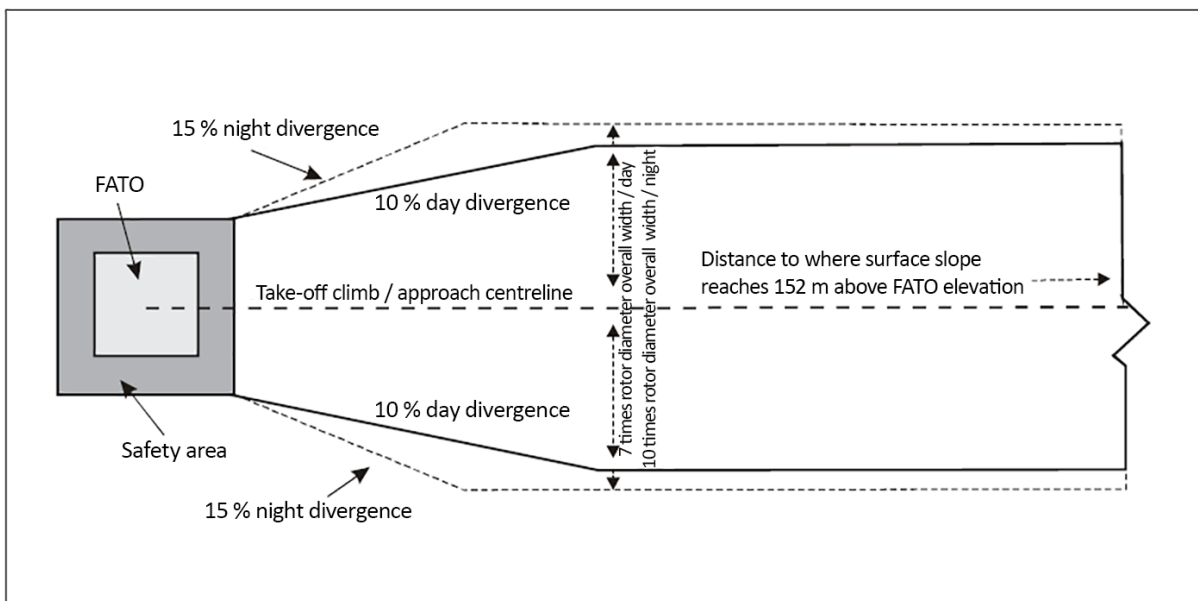


Note 1 - Dark grey shaded area requires the same characteristics as the safety area

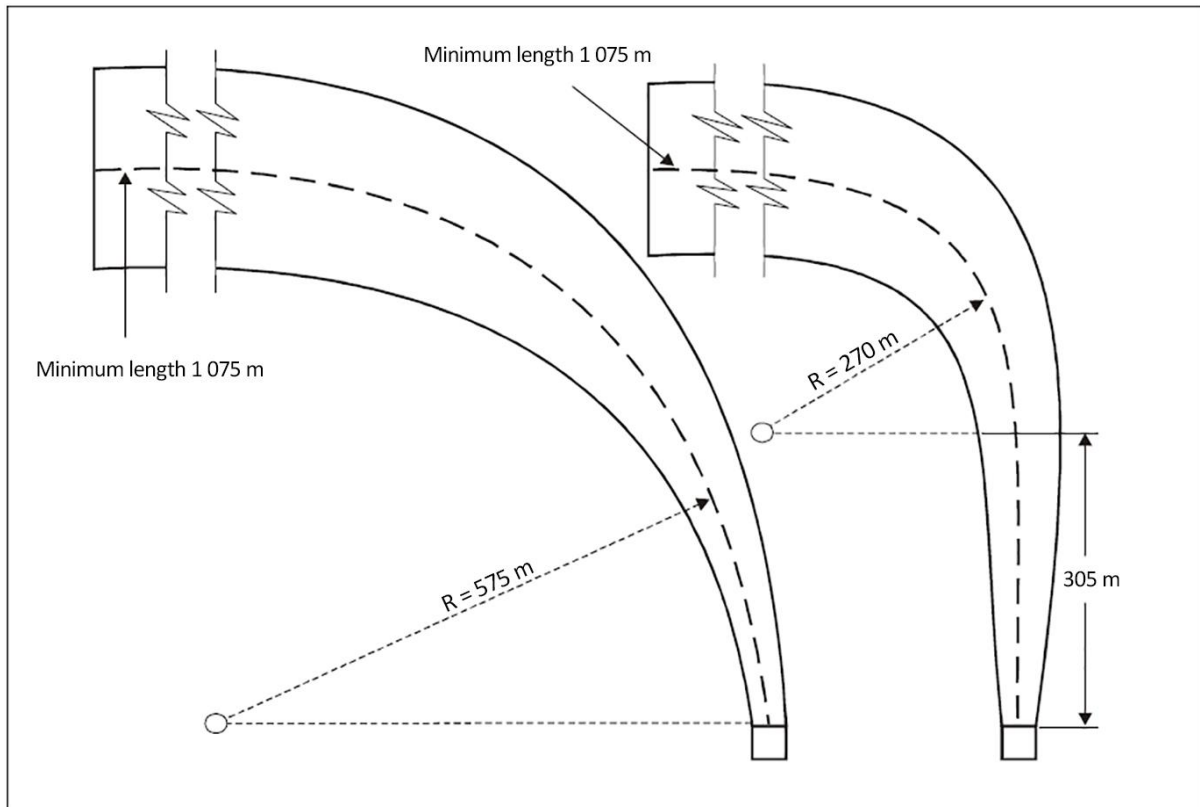
Note 2 - Angle between take-off climb/ approaches surfaces from centreline to centreline depicted for illustration purposes only

Note 3 - Offset take-off climb/approach surface rotated around centre point of FATO

**Figure E-1. Obstacle limitation surfaces — Take-off climb and approach surface**



**Figure E-2. Take-off climb/approach surface width**



Note 1 - Any combination of curve and straight portion may be established using the following formula:  $S+R \geq 575$  m and  $R \geq 270$  m where  $S = 305$  m, where  $S$  is the length of the straight portion and  $R$  is the radius of turn. Note any combination  $\geq 575$  m will work.

Note 2 - The minimum length of the centre line of the curve and straight portion is 1 075 m but may be longer depending upon the slope used. See table E-1 for longer lengths.

Note 3 - Helicopter take-off performance is reduced in a curve and as such a straight portion along the take-off climb surface prior to the start of the curve should be considered to allow for acceleration.

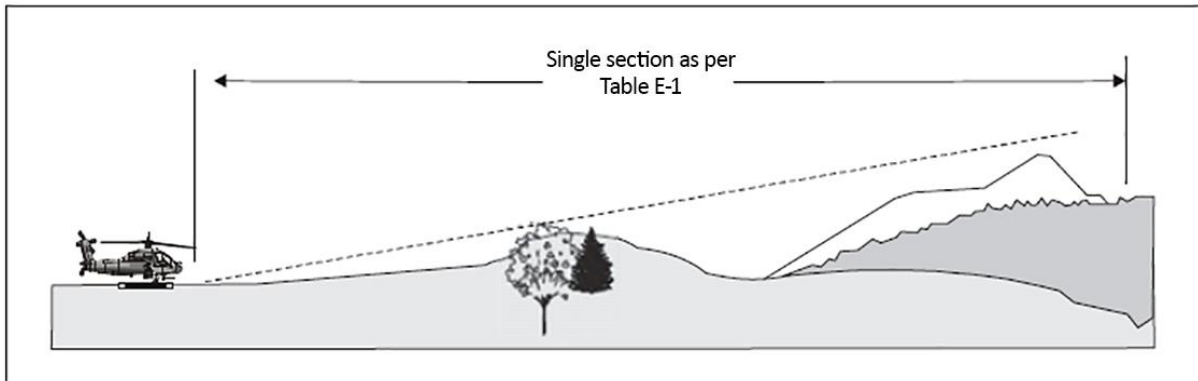
Figure E-3. Curved approach and take-off climb surface for all FATOs

SURFACE AND DIMENSIONS	SLOPE DESIGN CATEGORIES		
	A	B	C
APPROACH AND TAKE-OFF CLIMB SURFACE:			
Length of inner edge	Width of safety area	Width of safety area	Width of safety area
Location of inner edge	Safety area boundary (Clearway boundary if provided)	Safety area boundary	Safety area boundary
Divergence: (1st and 2nd section)			
Day use only	10 %	10 %	10 %
Night use	15 %	15 %	15 %
First section:			
Length	3 386 m	245 m	1 220 m
Slope	4.5 % (1:22.2)	8 % (1:12.5)	12.5 % (1:8)

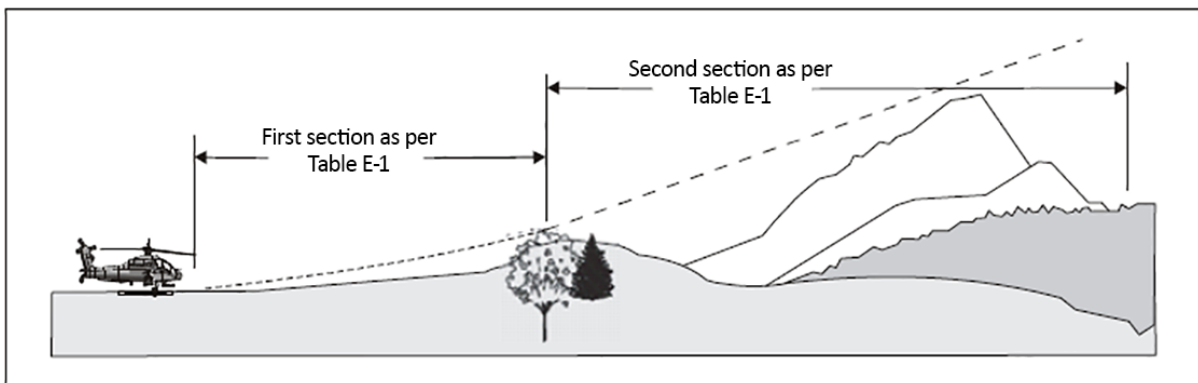


SURFACE AND DIMENSIONS	SLOPE DESIGN CATEGORIES		
	A	B	C
Outer width	(b)	N/A	(b)
Second section:			
Length	N/A	830 m	N/A
Slope	N/A	16 % (1:6.25)	N/A
Outer width	N/A	(b)	N/A
Total length from inner edge (a)	3 386 m	1 075 m	1 220 m
(a)	The approach and take-off climb surface lengths of 3 386 m, 1 075 m and 1 220 m associated with the respective slopes, bring the helicopter to 152 m (500 ft) above FATO elevation.		
(b)	7 rotor diameters overall width for day operations or 10 rotor diameters overall width for night operations.		
Note: The slope design categories depicted above represent minimum design slope angles and not operational slopes. Slope category 'A' generally corresponds with helicopters operated in performance class 1; slope category 'B' generally corresponds with helicopters operated in performance class 3; and slope category 'C' generally corresponds with helicopters operated in performance class 2.			

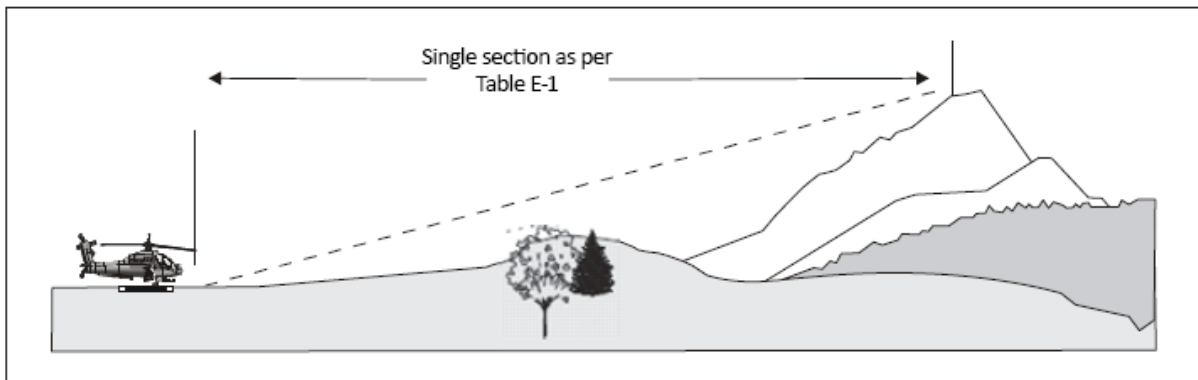
**Table E-1. Dimensions and slopes of obstacle limitation surfaces for all visual FATOs**



a) Approach and take-off climb surfaces – “A” slope profile – 4.5 % design



b) Approach and take-off climb surfaces – “B” slope profile – 8 % and 16 % design



c) Approach and take-off climb surfaces – “C” slope profile – 12.5 % design

**Figure E-4. Approach and take-off climb surfaces with different slope design categories**

## GM1 HPT-DSN.E.410 Approach surface

ED Decision 2019/012/R

- (a) Consultations with helicopter operators could assist the aerodrome operator in determining the appropriate slope category to apply according to the heliport environment and the most critical helicopter type for which the heliport is intended.

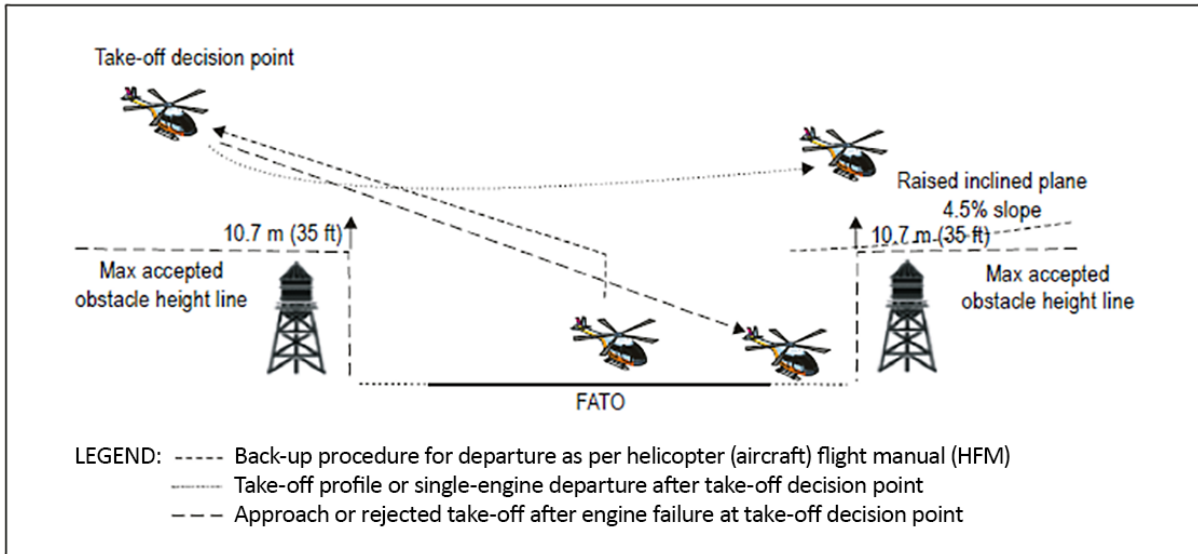


Figure GM1-E-1. Example of raised inclined plane during operations in performance class 1

- (b) The example shown in Figure GM1-E-1 does not represent any specific profile, technique or helicopter type and is intended to show a generic example. An approach profile and a back-up procedure for departure profile are depicted. Specific manufacturers operations in performance class 1 may be represented differently in the specific helicopter (aircraft) flight manual (HFM).
- (c) The approach/landing profile may not be the reverse of the take-off profile.
- (d) Additional safety assessment for obstacles might be required in the area that a back-up procedure is intended. Helicopter performance and the HFM limitations would determine the extent of the assessment required.
- (e) For heliports intended to be used by helicopters operated in performance class 2 and 3, it is good practice for the approach paths to be selected so as to permit safe forced landing or one-engine-inoperative landings such that, as a minimum requirement, injury to persons on the ground or water or damage to property are minimised. The most critical helicopter type for which the heliport is intended and the ambient conditions may be factors in determining the suitability of such areas.
- (f) The approach and take-off surfaces should be offset from each other ideally by an angle of not less than 135 degrees.

## CS HPT-DSN.E.420 Take-off climb surface

ED Decision 2019/012/R

- (a) Applicability: The purpose of the take-off climb surface is to protect a helicopter on take-off and during climb-out.
- (b) Description: An inclined plane, a combination of planes or, when a turn is involved, a complex surface sloping upwards from the end of the safety area and centred on a line passing through the centre of the FATO (see Figures E-1, E-2, E-3, and E-4, and Table E-1).
- (c) Characteristics:
  - (1) The limits of a take-off climb surface should comprise:

- (i) an inner edge horizontal and equal in length to the minimum specified width/diameter of the FATO plus the safety area, perpendicular to the centre line of the take-off climb surface and located at the outer edge of the safety area;
  - (ii) two side edges originating at the ends of the inner edge and diverging uniformly at a specified rate from the vertical plane containing the centre line of the FATO; and
  - (iii) an outer edge horizontal and perpendicular to the centre line of the take-off climb surface and at a specified height of 152 m (500 ft) above the elevation of the FATO.
- (2) The elevation of the inner edge should be the elevation of the FATO at the point on the inner edge that is intersected by the centre line of the take-off climb surface. For heliports intended to be used by helicopters operated in performance class 1, the inclined plane may be raised directly above the FATO.
  - (3) Where a clearway is provided the elevation of the inner edge of the take-off climb surface should be located at the outer edge of the clearway at the highest point on the ground based on the centre line of the clearway.
  - (4) In the case of a straight take-off climb surface, the slope should be measured in the vertical plane containing the centre line of the surface.
  - (5) In the case of a take-off climb surface involving a turn, the surface should be a complex surface containing the horizontal normals to its centre line and the slope of the centre line should be the same as that for a straight take-off climb surface (see Figure E-3).
  - (6) In the case of a take-off climb surface involving a turn, the surface should not contain more than one curved portion.
  - (7) Where a curved portion of a take-off climb surface is provided, the sum of the radius of the arc defining the centre line of the take-off climb surface and the length of the straight portion originating at the inner edge should not be less than 575 m.
  - (8) Any variation in the direction of the centre line of a take-off climb surface should be designed so as not to necessitate a turn of radius less than 270 m.

## **GM1 HPT-DSN.E.420 Take-off climb surface**

*ED Decision 2019/012/R*

- (a) Helicopter take-off performance is reduced in a curve, so a straight portion along the take-off climb surface prior to the start of the curve allows for acceleration.
- (b) For heliports intended to be used by helicopters operated in performance class 2 and 3, it is an operational requirement for departure paths to be selected so as to permit safe forced landings or one-engine-inoperative landings such that injury to persons on the ground or damage to property are minimised. The most critical helicopter type for which the heliport is intended and the ambient conditions may be factors in determining the suitability of such areas.
- (c) The approach and take-off surfaces should be offset from each other ideally by an angle of not less than 135 degrees.

## CS HPT-DSN.E.430 Obstacle limitation requirements

ED Decision 2019/012/R

- (a) General: The following obstacle limitation surfaces should be established for a FATO:
- (1) take-off climb surface; and
  - (2) approach surface.
- (b) Characteristics:
- (1) The slopes of the obstacle limitation surfaces should not be greater than, and their other dimensions not less than, those specified in Table E-1 and should be located as shown in Figures E-1, E-2 and E-4.
  - (2) Where a heliport visual approach slope indicator is installed, additional obstacle protection surfaces should be provided, as specified in [CS HPT-DSN.F.660](#), which can be more demanding than the obstacle limitation surfaces prescribed in Table E-1.
  - (3) For heliports that have an approach/take-off climb surface with a 4.5 per cent slope design, objects can be permitted to penetrate the obstacle limitation surface, if after a safety assessment, it is determined that the object would not adversely affect the safety or significantly affect the regularity of operations of helicopters.
  - (4) New objects or extensions of existing objects should not be permitted above the approach or take-off climb surfaces except when shielded by an existing immovable object or when after a safety assessment, it is determined that the object would not adversely affect the safety or significantly affect the regularity of operations of helicopters.
  - (5) Existing objects above the approach and take off climb surfaces should, as far as practicable, be removed except when the object is shielded by an existing immovable object or when after a safety assessment, it is determined that the object would not adversely affect the safety or significantly affect the regularity of operations of helicopters.
  - (6) When only a single approach and take-off climb surface is provided, a safety assessment should be undertaken considering as a minimum, the following factors:
    - (i) the area/terrain over which the flight is being conducted;
    - (ii) the obstacle environment surrounding the heliport;
    - (iii) the performance and operating limitations of helicopters intending to use the heliport; and
    - (iv) the local meteorological conditions including the prevailing winds.

## GM1 HPT-DSN.E.430 Obstacle limitation requirements

ED Decision 2019/012/R

Intentionally left blank

## CHAPTER F — VISUAL AIDS

### CS HPT-DSN.F.500 General

ED Decision 2019/012/R

- (a) When a FATO has similar characteristics to a runway, the applicable CSs are provided in the paragraphs below entitled 'runway-type FATO'.
- (b) For all other types of FATO, the applicable CSs are provided in the paragraphs below entitled 'All FATOs except runway-type FATOs'.

### GM1 HPT-DSN.F.500 General

ED Decision 2019/012/R

When a runway is marked in accordance with the provisions of CS-ADR-DSN, and is utilised as a FATO, no additional runway markings or lighting are required for helicopter use.

### CS HPT-DSN.F.510 Wind direction indicators

ED Decision 2019/012/R

Applicability: A heliport should be equipped with at least one wind direction indicator.

### GM1 HPT-DSN.F.510 Wind direction indicators

ED Decision 2019/012/R

- (a) General: If the wind direction indicators serving the aerodrome do not clearly indicate the correct wind information at the heliport, additional wind direction indicators should be installed in order to provide wind information to the pilot during approach and take-off.
- (b) Location:
  - (1) A wind direction indicator should be located so as to indicate the wind conditions over the FATO and TLOF and in such a way as to be free from the effects of airflow disturbances caused by nearby objects or rotor downwash. It should be visible from a helicopter in flight, in a hover or on the movement area.
  - (2) Where a TLOF and/or FATO are subject to a disturbed airflow, additional wind direction indicators located close to the area should be provided to indicate the surface wind on the area.
- (c) Characteristics:
  - (1) A wind direction indicator should give a clear indication of the direction of the wind and a general indication of the wind speed.
  - (2) A wind direction indicator for the heliport should be a truncated cone made of lightweight fabric and should have the following minimum dimensions:
    - (i) Length 2.4 m,
    - (ii) Diameter (larger end) 0.6 m, and
    - (iii) Diameter (smaller end) 0.3 m.

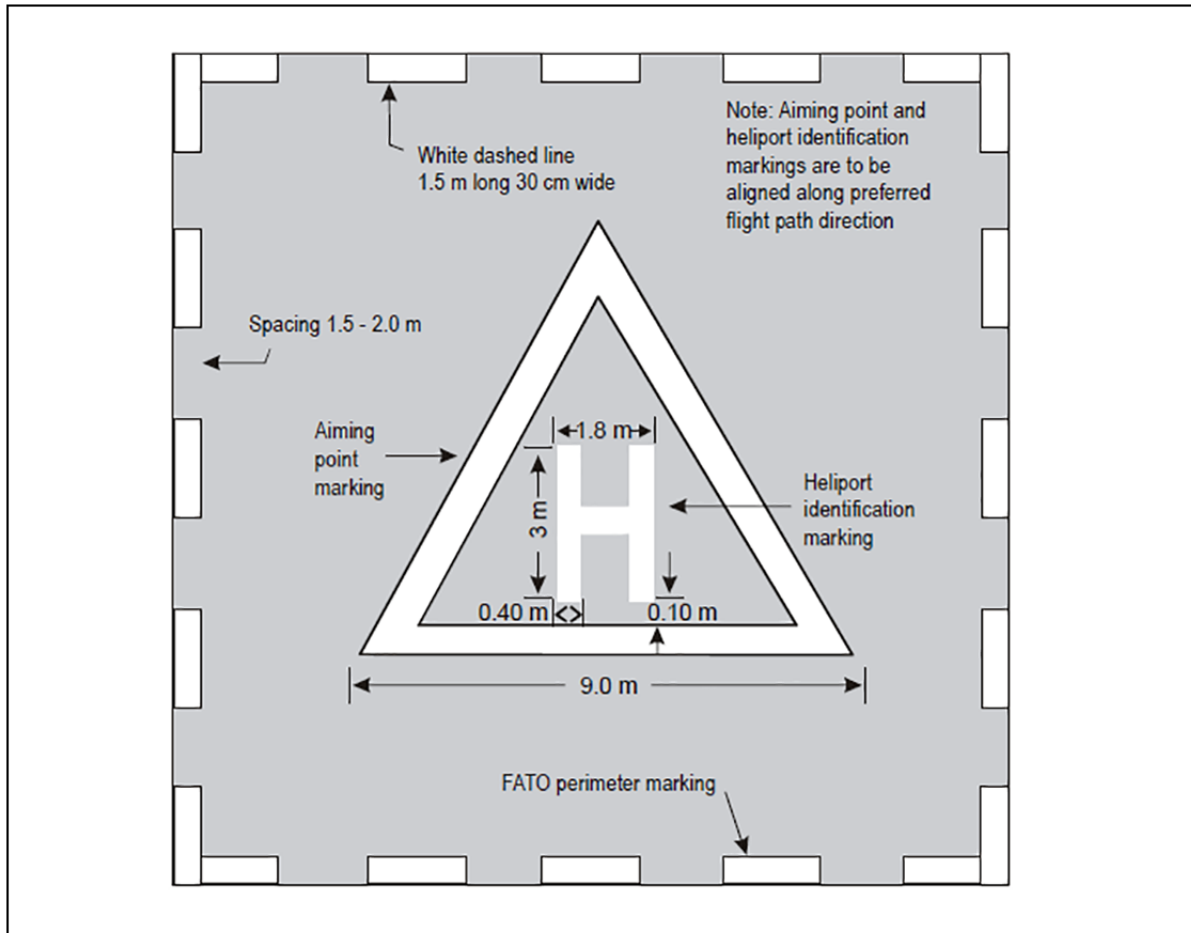
- (3) The colour of the wind direction indicator should be so selected as to make it clearly visible and understandable from a height of at least 200 m (650 ft) above the heliport, having regard to the background:
  - (i) where practicable, a single colour, preferably white or orange, should be used;
  - (ii) where a combination of two colours is required to give adequate conspicuity against changing backgrounds, they should preferably be orange and white, red and white, or black and white, and should be arranged in five alternate bands, the first and last band being the darker colour.
- (d) A wind direction indicator at a heliport intended for use at night should be illuminated.

## CS HPT-DSN.F.520 Heliport identification marking

ED Decision 2019/012/R

- (a) Applicability: Heliport identification markings should be provided at a heliport.
- (b) Location:
  - (1) For runway-type FATOs:

A heliport identification marking should be located in the FATO and when used in conjunction with FATO designation markings, should be displayed at each end of the FATO (see Figure F-2).
  - (2) For all FATOs except runway-type FATOs:
    - (i) A heliport identification marking should be located at or near the centre of the FATO (see Figure F-1).
    - (ii) On a FATO which contains a TLOF, a heliport identification marking should be located in the FATO so that the position of it coincides with the centre of the TLOF.
- (c) Characteristics:
  - (1) A heliport identification marking should consist of a letter 'H', white in colour. The dimensions of the 'H' marking should be no less than those shown in Figure F-3.
  - (2) Where the 'H' marking is used for a runway-type FATO, its dimensions should be increased by a factor of 3 (see Figures F-2 and F-3).
  - (3) A heliport identification marking should be oriented with the cross arm of the 'H' at right angles to the preferred final approach direction.



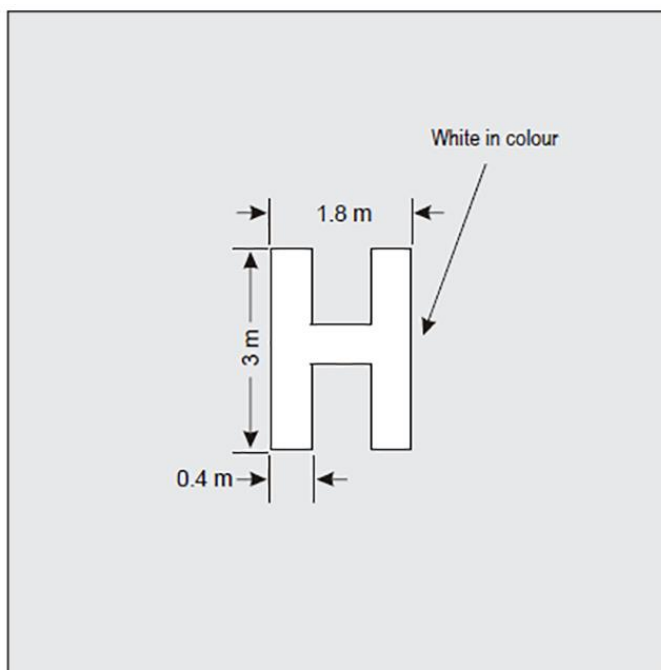
**Note:** The aiming point, heliport identification and FATO perimeter markings are white and may be edged with a 10 cm black border to improve contrast

**Figure F-1. Combined heliport identification, aiming point and FATO perimeter marking**



**Figure F-2. FATO designation marking and heliport identification marking for a runway-type FATO**





**Figure F-3. Heliport identification marking**

## GM1 HPT-DSN.F.520 Heliport identification marking

*ED Decision 2019/012/R*

On a FATO which does not contain a TLOF and which is marked with an aiming point marking (see [CS HPT-DSN.F.550](#)) the heliport identification marking should be established in the centre of the aiming point marking as shown in Figure F-1.

## CS HPT-DSN.F.530 Final approach and take-off area perimeter marking or markers

*ED Decision 2019/012/R*

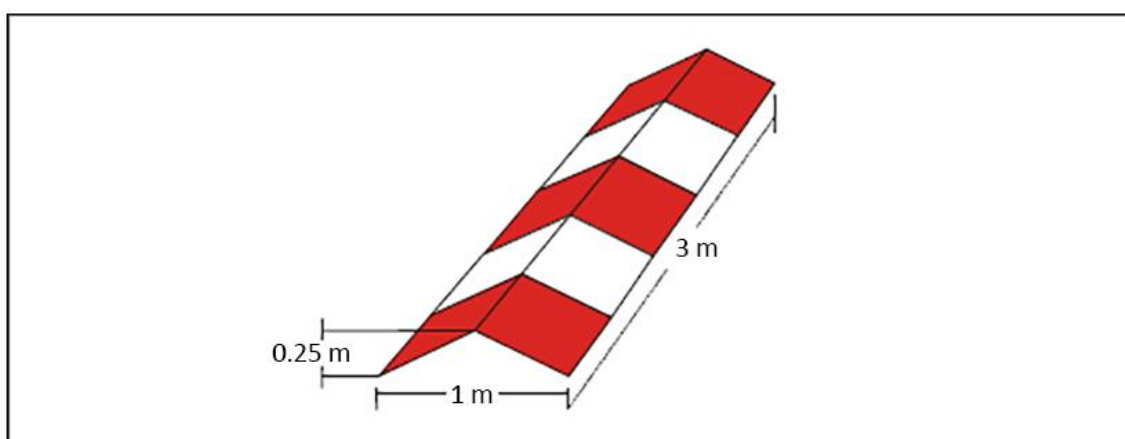
- (a) Applicability: FATO perimeter marking or markers should be provided where the extent of the FATO is not self-evident.
- (b) Location: The FATO perimeter marking or markers should be located on the edge of the FATO.
- (c) Characteristics:
  - (1) For runway-type FATOs:
    - (i) The perimeter of the FATO should be defined with markings or markers spaced at equal intervals of not more than 50 m with at least three markings or markers on each side including a marking or marker at each corner.
    - (ii) A FATO perimeter marking should be a rectangular stripe with a length of 9 m or one-fifth of the side of the FATO which it defines and a width of 1 m.
    - (iii) FATO perimeter markings should be white.
    - (iv) FATO perimeter markers should be of a colour (or colours) that contrasts (contrast) effectively against the operating background.
  - (2) For all FATOs except runway-type FATOs:

- (i) For an unpaved FATO, the perimeter should be defined with flush in-ground markers. The FATO perimeter markers should be 30 cm in width, 1.5 m in length, and with end-to-end spacing of not less than 1.5 m and not more than 2 m. The corners of a square or rectangular FATO should be defined.
- (ii) For a paved FATO, the perimeter should be defined with a dashed line. The FATO perimeter marking segments should be 30 cm in width, 1.5 m in length, and with end-to-end spacing of not less than 1.5 m and not more than 2 m. The corners of the square or rectangular FATO should be defined.
- (iii) FATO perimeter markings and flush in-ground markers should be white.

## GM1 HPT-DSN.F.530 Final approach and take-off area perimeter marking or markers

*ED Decision 2019/012/R*

- (a) Where a TLOF is coincident with a FATO, the TLOF marking can be used.
- (b) FATO perimeter markers should be of a single colour, either orange or red, or the two contrasting colours of orange and white or, alternatively, red and white should be used except where such colours would merge with the background. A FATO perimeter marker should have dimensional characteristics as shown in Figure GM1-F-1.



*Figure GM1-F-1. Runway-type FATO edge marker*

## CS HPT-DSN.F.540 Final approach and take-off area designation marking

*ED Decision 2019/012/R*

- (a) **Applicability:** A FATO designation marking should be provided on a runway-type FATO at a heliport where it is necessary to designate the FATO to the pilot.
- (b) **Location:** Where provided, a FATO designation marking should be located at the beginning of the runway-type FATO (see Figure F-2).
- (c) **Characteristics:** A FATO designation marking should consist of a two-digit number. The two-digit number should be the whole number nearest the one-tenth of the magnetic North when viewed from the direction of approach. When the above rule would give a single digit number, it should be preceded by a zero (see Figure F-2).

## GM1 HPT-DSN.F.540 Final approach and take-off area designation marking

ED Decision 2019/012/R

For a runway-type FATO, the numbers and the letter of the marking should have a white colour and should be in the form and proportion shown in Figure GM1-F-2.

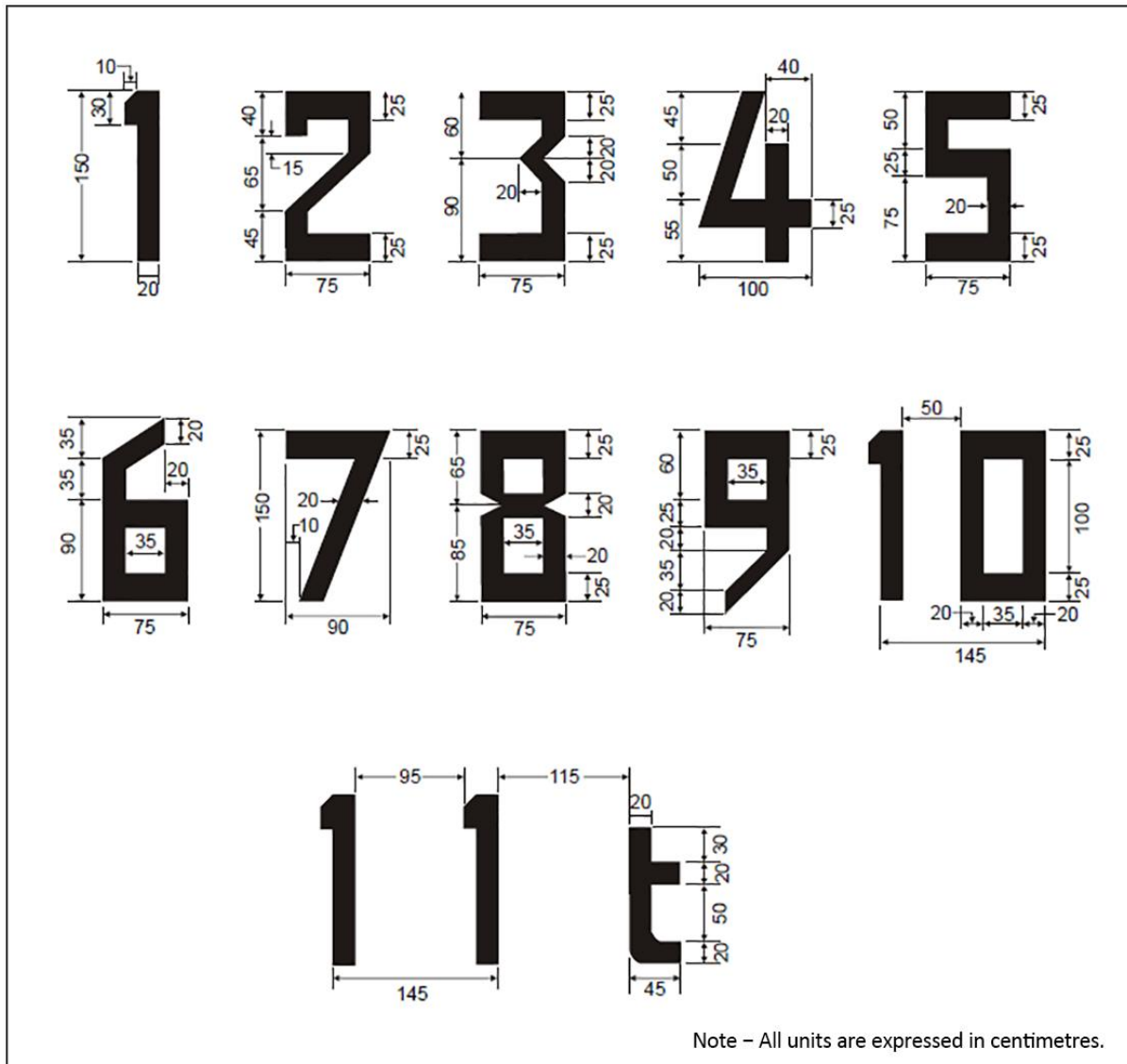


Figure GM1-F-2. Form and proportions of numbers and letter

## CS HPT-DSN.F.550 Aiming point marking

ED Decision 2019/012/R

- (a) The safety objective of an aiming point marking is to provide a visual cue indicating to the pilot the preferred approach/departure direction, to the point to which the helicopter approaches to hover before positioning to a stand where a touchdown should be made, and that the surface of the FATO is not intended for touchdown.
- (b) Location: Where provided, the aiming point marking should be located within the FATO (see Figure F-1).

- (c) Characteristics:
- (i) The aiming point marking should be an equilateral triangle with a minimum side length of 9.0 metres, with the bisector of one of the angles aligned with the preferred approach direction.
  - (ii) The marking should consist of continuous white lines, 1.0 m in width (see Figures F-1 and F-12).

### **GM1 HPT-DSN.F.550 Aiming point marking**

*ED Decision 2019/012/R*

For all FATOs except runway-type FATOs, the aiming point marking should be located at the centre of the FATO, as shown in Figure F-1.

### **CS HPT-DSN.F.560 Touchdown and lift-off area perimeter marking**

*ED Decision 2019/012/R*

- (a) The safety objective of the touchdown and lift-off area perimeter marking is to provide to the pilot a clear indication of a TLOF.
- (b) Applicability: When the perimeter of the TLOF is not self-evident, a TLOF perimeter marking should be displayed on a TLOF located in a FATO.
- (c) Location: Where provided, the TLOF perimeter marking should be located along the edge of the TLOF.
- (d) Characteristics: A TLOF perimeter marking should consist of a continuous white line with a width of at least 30 cm.

### **GM1 HPT-DSN.F.560 Touchdown and lift-off area perimeter marking**

*ED Decision 2019/012/R*

A TLOF perimeter marking should be provided on each TLOF collocated with a helicopter stand.

### **CS HPT-DSN.F.570 Touchdown/positioning marking**

*ED Decision 2019/012/R*

- (a) Applicability:
  - (1) A touchdown/positioning marking should be provided where it is necessary for a helicopter to touch down and/or be accurately positioned.
  - (2) A touchdown/positioning marking should be provided on a helicopter stand designed for turning.
- (b) Location:
  - (1) A touchdown/positioning marking should be located so that when the pilot's seat is over the marking, the whole of the undercarriage should be within the TLOF and all parts of the helicopter should be clear of any obstacle by a safe margin.
  - (2) On a heliport, the centre of the touchdown/positioning marking should be located at the centre of the TLOF, except the centre of the touchdown/positioning marking may be offset away from the centre of the TLOF where a safety assessment indicates such

offsetting to be necessary, and providing that a marking that is so offset would not adversely affect safety.

- (3) For a helicopter stand designed for hover turning, the touchdown/positioning marking should be located in the centre of the central zone (see Figure D-1).
- (c) Characteristics:
- (1) A touchdown/positioning marking should be a yellow circle and have a line width of at least 0.5 m.
  - (2) The inner diameter of the touchdown/positioning marking should be 0.5 D of the largest helicopter the TLOF and/or the helicopter stand is intended to serve.

## GM1 HPT-DSN.F.570 Touchdown/positioning marking

ED Decision 2019/012/R

Intentionally left blank

## CS HPT-DSN.F.580 Heliport name marking

ED Decision 2019/012/R

- (a) Applicability: A heliport name marking should be provided at a heliport where there is insufficient alternative means of visual identification.
- (b) Characteristics: A heliport name marking should consist of the name or the alphanumeric designator of the heliport as used in radio (R/T) communications.

## GM1 HPT-DSN.F.580 Heliport name marking

ED Decision 2019/012/R

- (a) Location: The heliport name marking should be displayed on the heliport so as to be visible, as far as practicable, at all angles above the horizontal.
- (b) Characteristics:
  - (1) A heliport name marking intended for use at night or during conditions of poor visibility should be illuminated, either internally or externally.
  - (2) The colour of the marking should contrast with the background and preferably be white.
  - (3) Runway-type FATOs: The characters of the marking should be not less than 3 m in height.
  - (4) All FATOs except runway-type FATOs: The characters of the marking should be not less than 1.5 m in height.

## CS HPT-DSN.F.590 Helicopter ground taxiway markings and markers

ED Decision 2019/012/R

- (a) Applicability:
  - (1) The specifications for runway-holding position markings defined in [CS ADR-DSN.L.575](#) and for intermediate holding position marking defined in [CS ADR-DSN.L.580](#) are equally applicable to taxiways intended for ground taxiing of helicopters.
  - (2) The centre line of a helicopter ground taxiway should be identified with a marking.

- (3) The edges of a helicopter ground taxiway, if not self-evident, should be identified with markers or markings.
- (b) Location:
- (1) Helicopter ground taxiway markings should be along the centre line, and, if provided, along the edges of a helicopter ground taxiway.
  - (2) Helicopter ground taxiway edge markers should be located at a distance of 0.5 m to 3 m beyond the edge of the helicopter ground taxiway.
  - (3) Where provided, helicopter ground taxiway edge markers should be spaced at intervals of not more than 15 m on each side of straight sections and 7.5 m on each side of curved sections with a minimum of four equally spaced markers per section.
- (c) Characteristics:
- (1) A helicopter ground taxiway centre line marking should be a continuous yellow line 15 cm in width.
  - (2) Helicopter ground taxiway edge markings should be a continuous double yellow line, each 15 cm in width, and spaced 15 cm apart (nearest edge to nearest edge).
  - (3) A helicopter ground taxiway edge marker should not exceed the height of a plane originating at a height of 25 cm above the plane of the helicopter ground taxiway, at a distance of 0.5 m from the edge of the helicopter ground taxiway and sloping upwards and outwards at a gradient of 5 per cent to a distance of 3 m beyond the edge of the helicopter ground taxiway.
  - (4) Helicopter ground taxiway edge markers should be frangible to the wheeled undercarriage of helicopters.
  - (5) A helicopter ground taxiway edge marker should be blue.
  - (6) If the helicopter ground taxiway is to be used at night, the edge markers should be internally illuminated or retro-reflective.

## GM1 HPT-DSN.F.590 Helicopter ground taxiway markings and markers

ED Decision 2019/012/R

- (a) Ground taxi-routes are not required to be marked.
- (b) Where necessary, signage should be provided on an aerodrome to indicate that a ground taxiway is suitable only for the use of helicopters.
- (c) A helicopter ground taxiway edge marker should not present a hazard for aircraft operations.

## CS HPT-DSN.F.600 Helicopter air taxiway markings and markers

ED Decision 2019/012/R

- (a) Applicability:
  - (1) The specifications for runway-holding position markings defined in [CS ADR-DSN.L.575](#) and intermediate holding position marking defined in [CS ADR-DSN.L.580](#) are equally applicable to taxiways intended for air taxiing of helicopters.

- (2) The centre line of a helicopter air taxiway or, if not self-evident, the edges of a helicopter air taxiway, should be identified with markers or markings.
- (b) Location:
- (1) A helicopter air taxiway centre line marking or flush in-ground centre line marker should be located along the centre line of the helicopter air taxiway.
  - (2) Helicopter air taxiway edge markings should be located along the edges of a helicopter air taxiway.
  - (3) Helicopter air taxiway edge markers should be located at a distance of 1 m to 3 m beyond the edge of the helicopter air taxiway.
- (c) Characteristics:
- (1) A helicopter air taxiway centre line should be marked with a continuous yellow line 15 cm in width, when on a paved surface.
  - (2) The edges of a helicopter air taxiway, when on a paved surface, should be marked with continuous double yellow lines each 15 cm in width, and spaced 15 cm apart (nearest edge to nearest edge).
  - (3) Where a helicopter air taxiway is located on an unpaved surface and painted markings of a helicopter air taxiway centre line cannot be provided, it should be marked with flush in-ground 15 cm wide and approximately 1.5 m in length yellow markers, spaced at intervals of not more than 30 m on straight sections and not more than 15 m on curves, with a minimum of four equally spaced markers per section.
  - (4) Helicopter air taxiway edge markers, where provided, should be spaced at intervals of not more than 30 m on each side of straight sections and not more than 15 m on each side of curves, with a minimum of four equally spaced markers per section.
  - (5) Helicopter air taxiway edge markers should be frangible.
  - (6) Helicopter air taxiway edge markers should not penetrate a plane originating at a height of 25 cm above the plane of the helicopter air taxiway, at a distance of 1 m from the edge of the helicopter air taxiway and sloping upwards and outwards at a gradient of 5 per cent to a distance of 3 m beyond the edge of the helicopter air taxiway.
  - (7) A helicopter air taxiway edge marker should be of a colour (or colours) that contrasts (contrast) effectively against the operating background. The red colour should not be used for markers.
  - (8) If the helicopter air taxiway is to be used at night, helicopter air taxiway edge markers should be either internally illuminated or retro-reflective.

## **GM1 HPT-DSN.F.600 Helicopter air taxiway markings and markers**

*ED Decision 2019/012/R*

- (a) Helicopter air taxi-routes are not required to be marked.
- (b) Where a helicopter air taxiway could be confused with a helicopter ground taxiway, signage should be provided to indicate the mode of taxi operations that are permitted.
- (c) Helicopter air taxiway edge markers should not be located at a distance from the centre line of the helicopter air taxiway of less than 0.5 times the largest overall width of the helicopter for which it is designed.

- (d) Helicopter air taxiway edge markers should not penetrate a plane originating at a height of 25 cm above the plane of the helicopter air taxiway, at a distance from the centre line of the helicopter air taxiway of 0.5 times the largest overall width of the helicopter for which it is designed, and sloping upwards and outwards at a gradient of 5 per cent.

## CS HPT-DSN.F.610 Helicopter stand markings

ED Decision 2019/012/R

- (a) Applicability:
- (1) A helicopter stand perimeter marking should be provided on a helicopter stand designed for turning. If a helicopter stand perimeter marking is not practicable, a central zone perimeter marking should be provided instead if the perimeter of the central zone is not self-evident.
  - (2) For a helicopter stand that is intended to be used for taxi-through and which does not allow a helicopter to turn, a stop line should be provided.
  - (3) Alignment lines and lead-in/lead-out lines should be provided on a helicopter stand (see Figures F-4 and F-5).
- (b) Location:
- (1) A helicopter stand perimeter marking on a helicopter stand designed for turning or, a central zone perimeter marking, should be concentric with the central zone of the stand.
  - (2) For a helicopter stand that is intended to be used for taxi-through and which does not allow the helicopter to turn, a stop line should be located on the helicopter ground taxiway axis at right angles to the centre line.



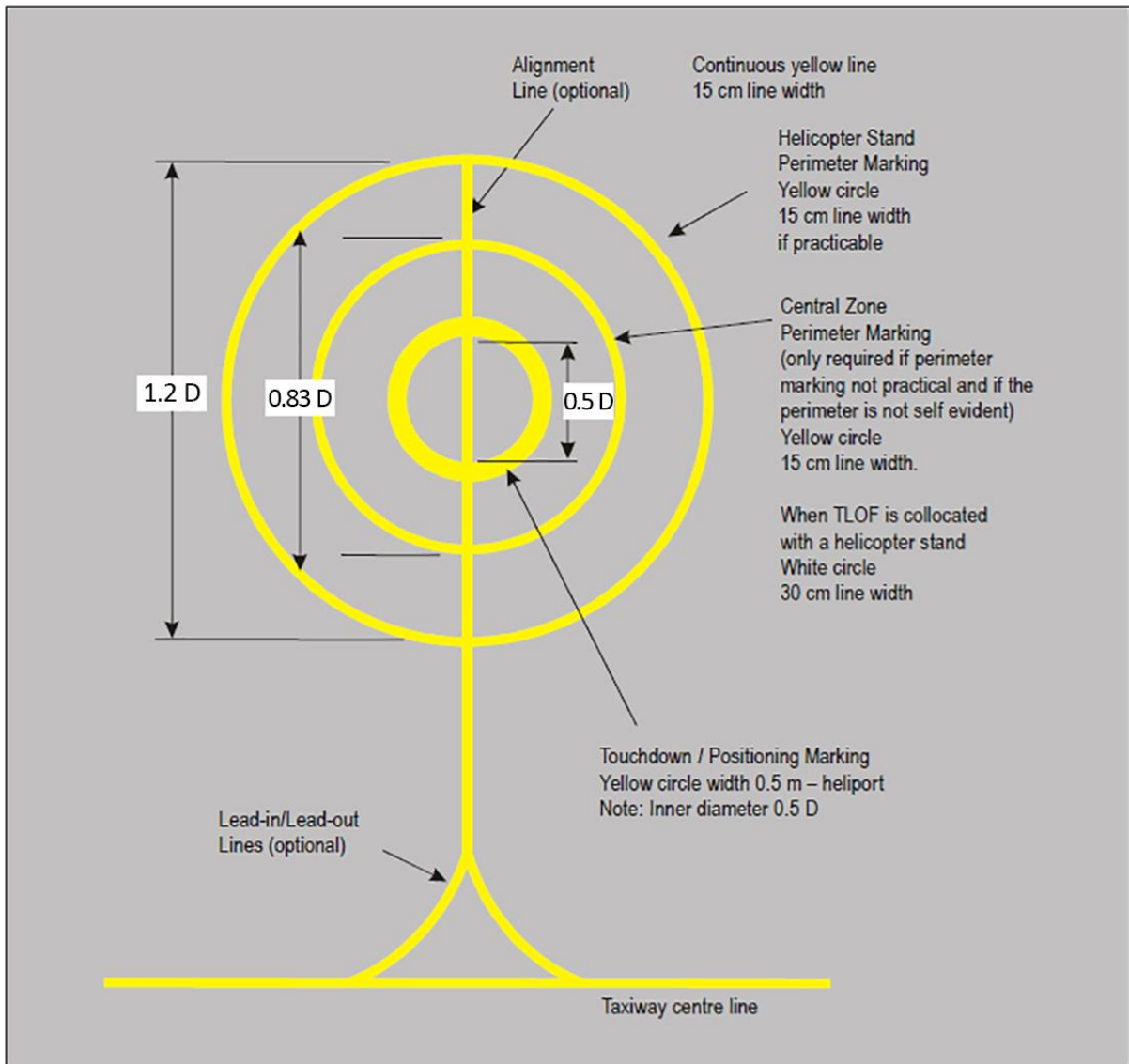


Figure F-4. Helicopter stand markings at a stand designated for hover turning

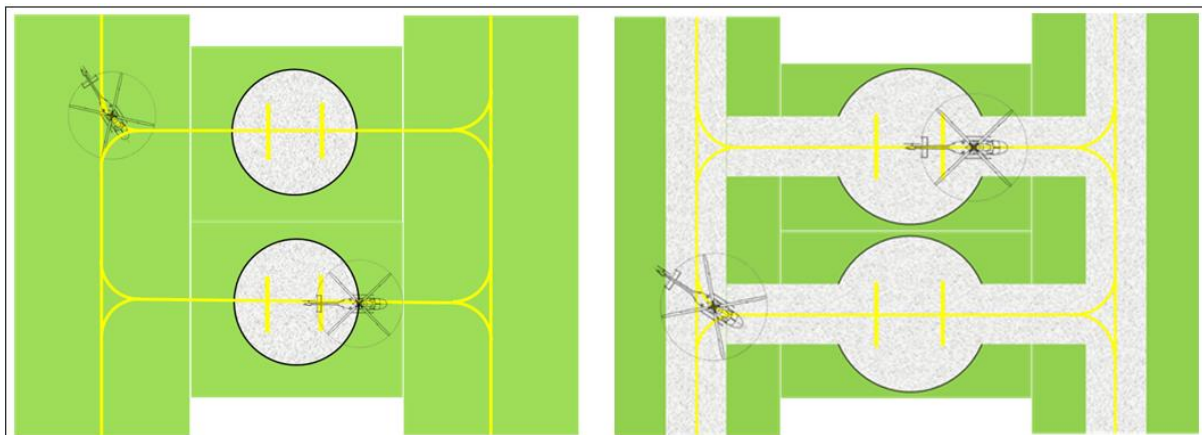


Figure F-5. Taxi through helicopter stand markings

- (c) Characteristics:
- (1) A helicopter stand perimeter marking should be a yellow circle and have a line width of 15 cm.
  - (2) A central zone perimeter marking should be a yellow circle and have a line width of 15 cm, except when the TLOF is collocated with a helicopter stand, in which case the characteristics of the TLOF perimeter markings should apply.
  - (3) For a helicopter stand that is intended to be used for taxi-through and which does not allow the helicopter to turn, the yellow stop line should not be less than the width of the helicopter ground taxiway and should have a line thickness of 50 cm.
  - (4) Alignment lines and lead-in/lead-out lines should be continuous yellow lines and should have a width of 15 cm.
  - (5) Curved portions of alignment lines and lead-in/lead-out lines should have radii appropriate to the most demanding helicopter type the helicopter stand is intended to serve.
  - (6) Stand identification markings should be marked in a contrasting colour so as to be easily readable.
  - (7) Where it is intended that helicopters proceed in one direction only, arrows indicating the direction to be followed may be added as part of the alignment lines.

## GM1 HPT-DSN.F.610 Helicopter stand markings

ED Decision 2019/012/R

Helicopter stand identification markings should be provided where there is a need to identify individual stands.

## CS HPT-DSN.F.620 Flight path alignment guidance marking

ED Decision 2019/012/R

- (a) Applicability: Where provided at a heliport, a flight path alignment guidance marking (or markings) should indicate the available approach and/or departure path direction(s).
- (b) Location: The flight path alignment guidance marking should be located in a straight line along the direction of approach and/or departure path on one or more of the TLOF, FATO, safety area or any suitable surface in the immediate vicinity of the FATO or the safety area.
- (c) Characteristics:
  - (1) A flight path alignment guidance marking should consist of one or more arrows marked on the TLOF, FATO and/or safety area surface, as shown in Figure F-6. The stroke of the arrow(s) should be 50 cm in width and at least 3 m in length. When combined with a flight path alignment guidance lighting system, it should take the form shown in Figure F-6, which includes the scheme for marking the 'heads of the arrows', which are always of the same size, regardless of the stroke length.
  - (2) In the case of a flight path limited to a single approach direction or a single departure direction, the arrow marking may be unidirectional. In the case of a heliport with only a single approach/departure path available, one bidirectional arrow is marked.
  - (3) The markings should be in a colour, preferably white, which provides good contrast against the background colour of the surface on which they are marked.

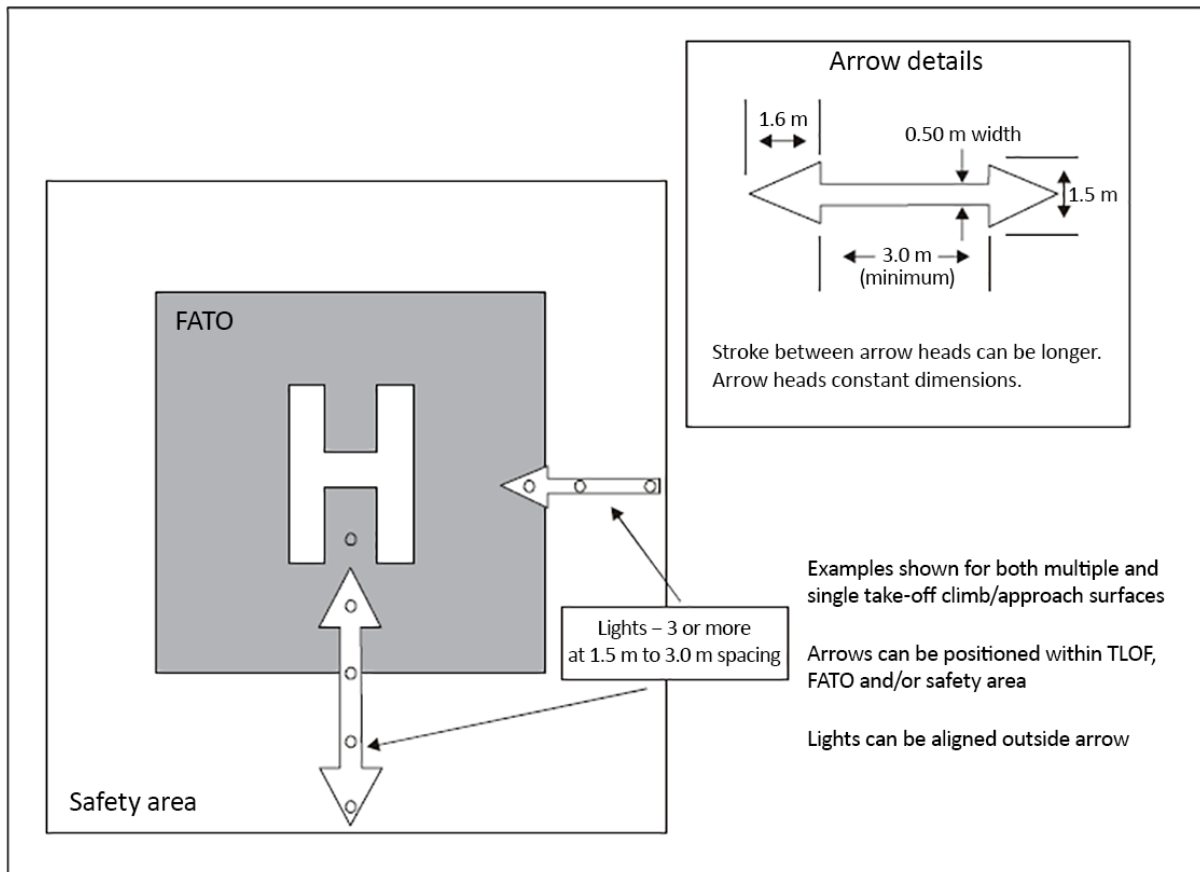


Figure F-6. Flight path alignment guidance markings and lights

## GM1 HPT-DSN.F.620 Flight path alignment guidance marking

ED Decision 2019/012/R

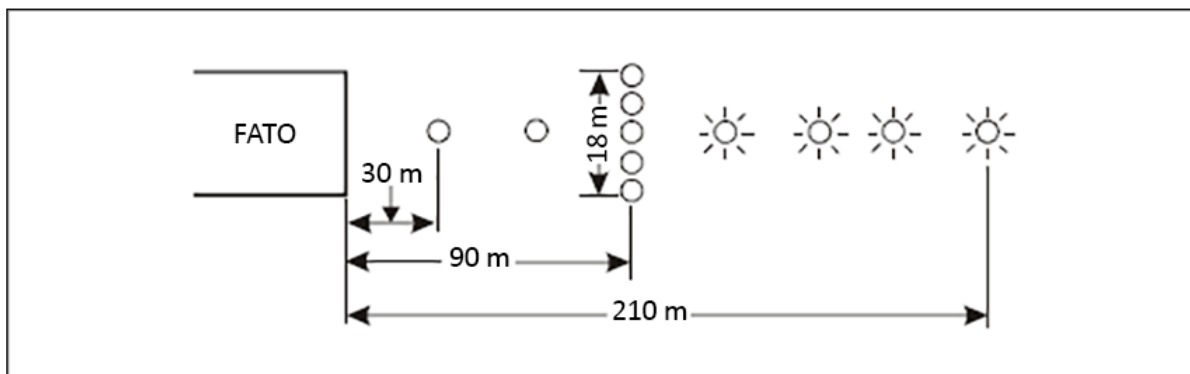
Intentionally left blank

## CS HPT-DSN.F.630 Approach lighting system

ED Decision 2019/012/R

- (a) Applicability: Where provided at a heliport, an approach lighting system should indicate a preferred approach direction.
- (b) Location: The approach lighting system should be located in a straight line along the preferred direction of approach.
- (c) Characteristics:
  - (1) An approach lighting system should consist of a row of three lights spaced uniformly at 30 m intervals and of a crossbar 18 m in length at a distance of 90 m from the perimeter of the FATO as shown in Figure F-7. The lights forming the crossbar should be as nearly as practicable in a horizontal straight line at right angles to, and bisected by, the line of the centre line lights, and spaced at 4.5 m intervals.
  - (2) Where there is a need to make the final approach course more conspicuous, additional lights spaced uniformly at 30 m intervals should be added beyond the crossbar. The lights beyond the crossbar may be steady or sequenced flashing, depending upon the environment.

- (3) The steady lights should be omnidirectional white lights.
- (4) Sequenced flashing lights should be omnidirectional white lights.
- (5) The flashing lights should have a flash frequency of one per second and their light distribution should be as shown in Figure F-9, Illustration 2. The flash sequence should commence from the outermost light and progress towards the crossbar.
- (6) A suitable brilliancy control should be incorporated to allow for adjustment of light intensity to meet the prevailing conditions.



**Figure F-7. Approach lighting system**

## GM1 HPT-DSN.F.630 Approach lighting system

*ED Decision 2019/012/R*

Additional guidance on light intensity controls is given in [GM1 ADR-DSN.M.615](#).

## CS HPT-DSN.F.640 Flight path alignment guidance lighting system

*ED Decision 2019/012/R*

- (a) **Applicability:** Where provided at a heliport, a flight path alignment guidance lighting system (or systems) should indicate the available approach and/or departure path direction(s).
- (b) **Location:**
  - (1) The flight path alignment guidance lighting system should be in a straight line along the direction(s) of approach and/or departure path on one or more of the TLOF, FATO, safety area or any suitable surface in the immediate vicinity of the FATO, TLOF or safety area.
  - (2) If combined with a flight path alignment guidance marking, then as far as is practicable, the lights should be located inside the 'arrow' markings.
- (c) **Characteristics:**
  - (1) A flight path alignment guidance lighting system should consist of a row of three or more lights spaced uniformly over a total minimum distance of 6 m. Intervals between lights should not be less than 1.5 m and should not exceed 3 m.
  - (2) Where space permits, there should be 5 lights. The number of lights and the spacing between these lights may be adjusted to reflect the space available.
  - (3) If more than one flight path alignment system is used to indicate the available approach and/or departure path direction(s), the characteristics for each system are typically kept the same (see Figure F-6).

- (4) The lights should be steady omnidirectional inset white lights.
- (5) The distribution of the lights should be as indicated in Figure F-9, Illustration 5.
- (6) A suitable control should be incorporated to allow for adjustment of light intensity to meet the prevailing conditions and to balance the flight path alignment guidance lighting system with other heliport lights and general lighting that may be present around the heliport.

## **GM1 HPT-DSN.F.640 Flight path alignment guidance lighting system**

*ED Decision 2019/012/R*

The flight path alignment guidance lighting can be combined with a flight path alignment guidance marking (or markings).

## **CS HPT-DSN.F.650 Visual alignment guidance system**

*ED Decision 2019/012/R*

- (a) **Applicability:** Where provided at a heliport, a visual alignment guidance system should provide guidance to the pilot during the approach to a heliport.
- (b) **Location:**
  - (1) The visual alignment guidance system should be located such that a helicopter is guided along the prescribed track towards the FATO.
  - (2) The system should be located at the downwind edge of the FATO and aligned along the preferred approach direction.
  - (3) The light units should be frangible and mounted as low as possible.
  - (4) Where the lights of the system need to be seen as discrete sources, light units should be located such that at the extremes of system coverage, the angle subtended between the units as seen by the pilot should not be less than 3 minutes of arc.
  - (5) The angles subtended between the light units of the system and other units of comparable or greater intensities should also be not less than 3 minutes of arc.
  - (6) The requirements of paragraphs (4) and (5) above can be met for lights on a line normal to the line of sight if the light units are separated by 1 m for every kilometre of viewing range.
- (c) **Signal format:**
  - (1) The signal format of the alignment guidance system should include a minimum of three discrete signal sectors providing 'offset to the right', 'on track' and 'offset to the left' signals.
  - (2) The divergence of the 'on track' sector of the system should be 1° as shown in Figure F-8.
  - (3) The signal format should be such that there is no possibility of confusion between the system and any associated visual approach slope indicator or other visual aids.
  - (4) The system should avoid the use of the same coding as any associated visual approach slope indicator.

- (5) The signal format should be such that the system is unique and conspicuous in all operational environments.
- (6) The system should not significantly increase the pilot workload.
- (d) Light distribution:
  - (1) The usable coverage of the visual alignment guidance system should be equal to or better than that of the visual approach slope indicator system with which it is associated.
  - (2) A suitable intensity control should be provided so as to allow adjustment to meet the prevailing conditions and to avoid dazzling the pilot during approach and landing.
- (e) Approach track and azimuth setting:
  - (1) A visual alignment guidance system should be capable of adjustment in azimuth to within  $\pm 5$  minutes of arc of the desired approach path.
  - (2) The angle of the azimuth guidance system should be such that during an approach, the pilot of a helicopter at the boundary of the 'on track' signal would clear all objects in the approach area by a safe margin.
  - (3) The characteristics of the obstacle protection surface specified in [CS HPT-DSN.F.660\(h\)\(2\)](#), Table F-1 and Figure F-10 should equally apply to the system.
- (f) Characteristics of the visual alignment guidance system:
  - (1) In the event of a failure of any component affecting the signal format, the system should be automatically switched off.
  - (2) The light units should be so designed that deposits of condensation, ice, dirt, etc. on optically transmitting or reflecting surfaces would interfere to the least possible extent with the light signal and should not cause spurious or false signals to be generated.

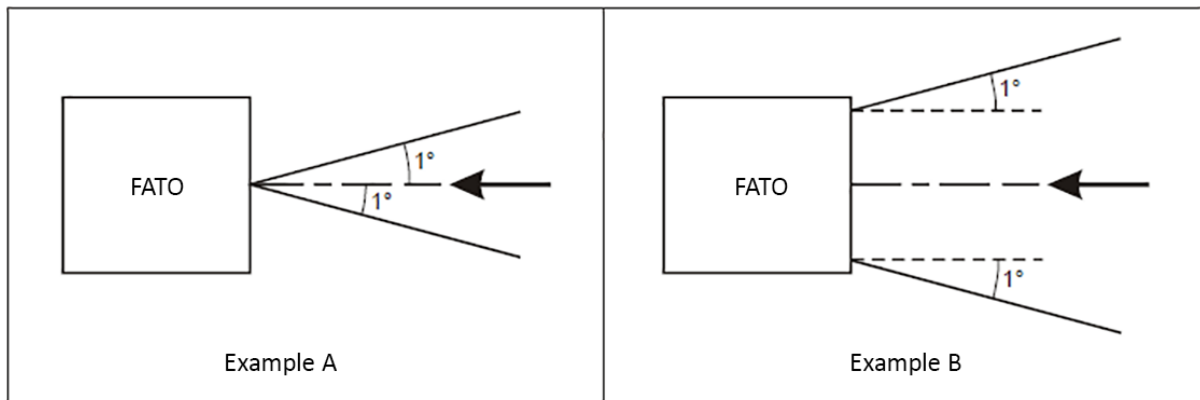


Figure F-8. Divergence of the 'on track' sector

Elevation	
15°	25 cd
9°	250 cd
6°	350 cd
5°	350 cd
2°	250 cd
0°	25 cd
-180° Azimuth	+180°

(white light)

Illustration 1 – Approach light steady burning

Elevation	
15°	250 cd*
9°	2 500 cd*
6°	3 500 cd*
5°	3 500 cd*
2°	2 500 cd*
0°	250 cd*
-180° Azimuth	+180°

(white light)

\* Effective intensity

Illustration 2 – Approach light flashing

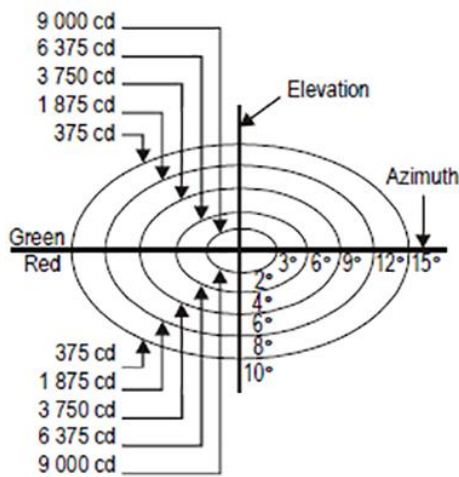


Illustration 3 – HAPI system

Elevation	
30°	10 cd
25°	50 cd
20°	100 cd
10°	
3°	100 cd
0°	10 cd
-180° Azimuth	+180°

Illustration 4 – Final approach and take-off lights and aiming point lights

Elevation (E)	
20° < E 90°	3 cd
13° < E 20°	8 cd
10° < E 13°	15 cd
5° < E 10°	30 cd
2° E 5°	15 cd
-180° Azimuth	+180°

(green or white light)

Note – Additional values may be required in the case of installations requiring identification by means of the lights at an elevation of less than two degrees.

Illustration 5 – TLOF perimeter lights and flight path alignment guidance lighting system

Elevation	
90°	55 cd/m <sup>2</sup>
60°	55 cd/m <sup>2</sup>
40°	50 cd/m <sup>2</sup>
30°	45 cd/m <sup>2</sup>
20°	30 cd/m <sup>2</sup>
10°	15 cd/m <sup>2</sup>
0°	5 cd/m <sup>2</sup>
-180° Azimuth	+180°

(green light)

Illustration 6 – Touchdown and lift-off area luminescent panels

Figure F-9. Isocandela diagrams

SURFACE AND DIMENSIONS		FATO
Length of inner edge		Width of safety area
Distance from end of FATO		3 m minimum
Divergence		10 %
Total length		2 500 m
Slope	PAPI	A <sup>a</sup> – 0.57°
	HAPI	A <sup>b</sup> – 0.65°
	APAPI	A <sup>a</sup> – 0.9°

a. As indicated in CS ADR-DSN.M.645, Figure M-4.  
b. The angle of the upper boundary of the ‘below slope’ signal.

Table F-1. Dimensions and slopes of the obstacle protection surface for heliport visual approach indicator system

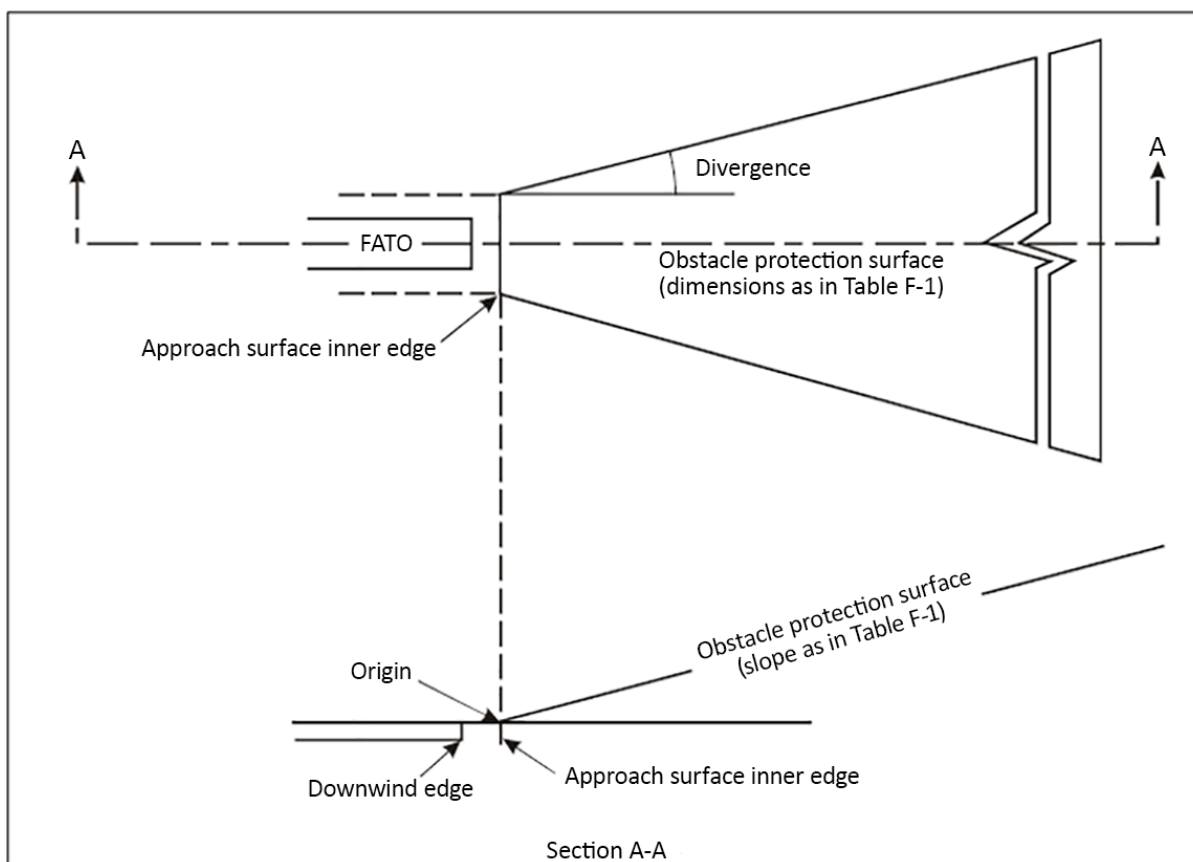


Figure F-10. Obstacle protection surface for visual approach slope indicator systems

## GM1 HPT-DSN.F.650 Visual alignment guidance system

ED Decision 2019/012/R

A visual alignment guidance system should be provided where one or more of the following conditions exist:

- (a) obstacle clearance, noise abatement or traffic control procedures require a particular direction to be flown;
- (b) the environment of the heliport provides few visual surface cues; and
- (c) it is physically impracticable to install an approach lighting system.



## CS HPT-DSN.F.660 Visual approach slope indicator

ED Decision 2019/012/R

- (a) Applicability: Where provided at a heliport, a visual slope indicator system should provide information on the approach angle necessary to maintain a safe height over obstacles on the approach to a heliport.
- (b) The standard visual approach slope indicator systems for helicopter operations should consist of the following:
  - (1) PAPI (precision approach path indicator) and APAPI (abbreviated precision approach path indicator) systems conforming to the specifications contained in [CS ADR-DSN.M.645](#) and [CS ADR-DSN.M.650](#), except that the angular size of the on-slope sector of the systems should be increased to 45 minutes of arc; or
  - (2) HAPI (helicopter approach path indicator) system conforming to the specifications in paragraphs (d) to (g) below.
- (c) Location:
  - (1) A visual approach slope indicator should be located such that a helicopter is guided to the desired position within the FATO and so as to avoid dazzling the pilot during final approach and landing.
  - (2) The light unit(s) should be mounted as low as possible.
- (d) Characteristics of the HAPI signal format:
  - (1) The signal format of the HAPI should include four discrete signal sectors, providing an 'above slope', an 'on slope', a 'slightly below' and a 'below slope' signal.
  - (2) The signal format of the HAPI should be as shown in Figure F-11, Illustrations A and B.
  - (3) The signal repetition rate of the flashing sector of the HAPI should be at least 2 Hz.
  - (4) The on-to-off ratio of pulsing signals of the HAPI should be 1 to 1, and the modulation depth should be at least 80 per cent.
  - (5) The angular size of the 'on-slope' sector of the HAPI should be 45 minutes of arc.
  - (6) The angular size of the 'slightly below' sector of the HAPI should be 15 minutes of arc.

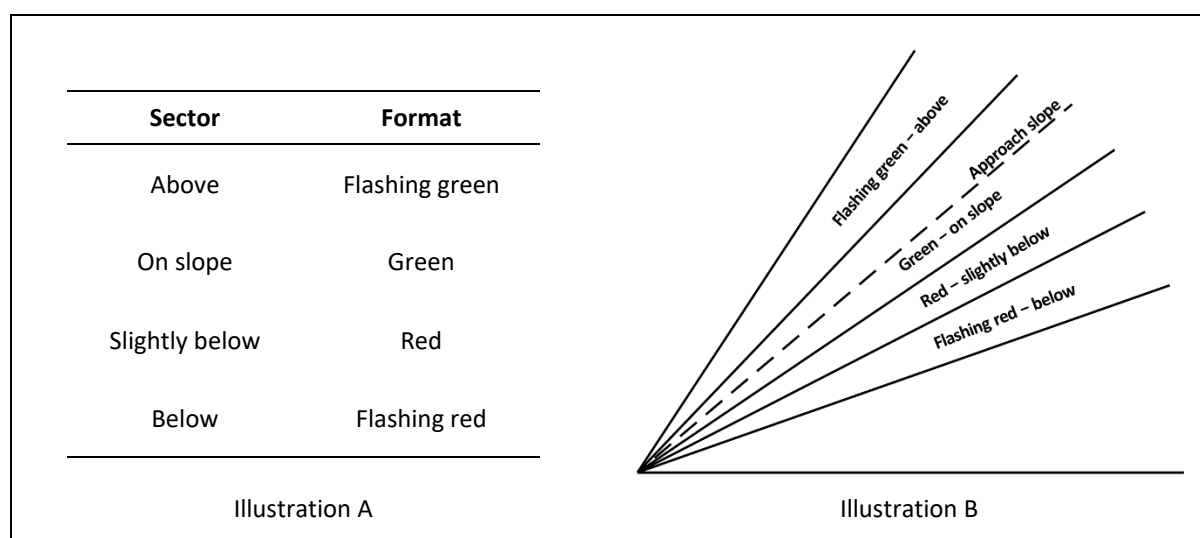


Figure F-11. HAPI signal format

- (e) Light distribution:
- (1) The light intensity distribution of the HAPI in red and green colours should be as shown in Figure F-9, Illustration 3.
  - (2) The colour transition of the HAPI in the vertical plane should be such as to appear to an observer at a distance of not less than 300 m to occur within a vertical angle of not more than three minutes of arc.
  - (3) The transmission factor of a red or green filter should be not less than 15 per cent at the maximum intensity setting.
  - (4) At full intensity, the red light of the HAPI should have a Y-coordinate not exceeding 0.320, and the green light should be within the boundaries specified in [CS ADR-DSN.U.930\(b\)](#).
  - (5) A suitable intensity control should be provided so as to allow adjustment to meet the prevailing conditions and to avoid dazzling the pilot during approach and landing.
- (f) Approach slope and elevation setting:
- (1) A HAPI system should be capable of adjustment in elevation at any desired angle between 1 degree and 12 degrees above the horizontal with an accuracy of  $\pm 5$  minutes of arc.
  - (2) The angle of elevation setting of a HAPI should be such that during an approach, the pilot of a helicopter observing the upper boundary of the 'below slope' signal would clear all objects in the approach area by a safe margin.
- (g) Characteristics of the light unit:
- (1) The system should be so designed that:
    - (i) in the event the vertical misalignment of a unit exceeds  $\pm 0.5$  degrees ( $\pm 30$  minutes), the system should switch off automatically; and
    - (ii) if the flashing mechanism fails, no light is emitted in the failed flashing sector(s).
  - (2) The light unit of the HAPI should be so designed that deposits of condensation, ice, dirt, etc. on optically transmitting or reflecting surfaces would interfere to the least possible extent with the light signal and should not cause spurious or false signals to be generated.
- (h) Obstacle protection surface (applicable to PAPI, APAPI and HAPI):
- (1) An obstacle protection surface should be established when it is intended to provide a visual approach slope indicator system.
  - (2) The characteristics of the obstacle protection surface, i.e. origin, divergence, length and slope, should correspond to those specified in the relevant column of Table F-1 and in Figure F-10.
  - (3) New objects or extensions of existing objects should not be permitted above an obstacle protection surface except when the new object or extension would be shielded by an existing immovable object.
  - (4) Existing objects above an obstacle protection surface should be removed except when the object is shielded by an existing immovable object, or when after a safety assessment, it is determined that the object would not adversely affect the safety of operations of helicopters.
  - (5) Where a safety assessment indicates that an existing object extending above an obstacle protection surface could adversely affect the safety of operations of helicopters, one or more of the following measures should be taken:

- (i) suitably raise the approach slope of the system;
- (ii) reduce the azimuth spread of the system so that the object is outside the confines of the beam;
- (iii) displace the axis of the system and its associated obstacle protection surface by no more than 5 degrees;
- (iv) suitably displace the FATO; and
- (v) install a visual alignment guidance system.

## **GM1 HPT-DSN.F.660 Visual approach slope indicator**

*ED Decision 2019/012/R*

- (a) A visual approach slope indicator should be provided for a heliport where one or more of the following conditions exist:
  - (1) obstacle clearance, noise abatement or traffic control procedures require a particular slope to be flown;
  - (2) the environment of the heliport provides few visual surface cues; and
  - (3) the characteristics of the helicopter require a stabilised approach.
- (b) When more than one visual approach slope indicator is installed at an aerodrome (e.g. PAPI, APAPI), a visual approach slope indicator should be designed and calibrated in order to give a clear and unambiguous indication to helicopter pilots approaching to land.
- (c) A heliport visual approach slope indicator should be located adjacent to the nominal aiming point and aligned in azimuth with the preferred approach direction.
- (d) Care is required in the design of the unit to minimise spurious signals between the signal sectors, and at the azimuth coverage limits.
- (e) Larger azimuth coverage can be obtained by installing the HAPI system on a turntable.

## **CS HPT-DSN.F.670 Final approach and take-off area lighting systems**

*ED Decision 2019/012/R*

- (a) **Applicability:** FATO lights should be provided where a FATO is established at a heliport intended for use at night. They can be omitted where the FATO and the TLOF are nearly coincidental and the TLOF lights are provided, or the extent of the FATO is self-evident.
- (b) **Location:** FATO lights should be placed along the edges of the FATO. The lights should be uniformly spaced as follows:
  - (1) for an area in the form of a square or rectangle, at intervals of not more than 50 m with a minimum of four lights on each side including a light at each corner; and
  - (2) for any other shaped area, including a circular area, at intervals of not more than 5 m with a minimum of ten lights.
- (c) **Characteristics:**
  - (1) FATO lights should be fixed omnidirectional lights showing white. Where the intensity of the lights is to be varied, the lights should show variable white.

- (2) The light distribution of FATO lights should be as shown in Figure F-9, Illustration 4.
- (3) The lights should not exceed a height of 25 cm and should be inset when a light extending above the surface would endanger helicopter operations.
- (4) Where a FATO is not meant for lift-off or touchdown, the lights should not exceed a height of 25 cm above ground or snow level.

## GM1 HPT-DSN.F.670 Final approach and take-off area lighting systems

ED Decision 2019/012/R

Intentionally left blank

## CS HPT-DSN.F.680 Aiming point lights

ED Decision 2019/012/R

- (a) Applicability: Aiming point lights should be provided where an aiming point marking is provided at a heliport intended for use at night.
- (b) Location: Aiming point lights should be collocated with the aiming point marking.
- (c) Characteristics:
  - (1) Aiming point lights should form a pattern of at least six omnidirectional white lights (see Figure F-12).
  - (2) The lights should be inset when a light extending above the surface could endanger helicopter operations.
  - (3) The light distribution of aiming point lights should be as shown in Figure F-9, Illustration 4.

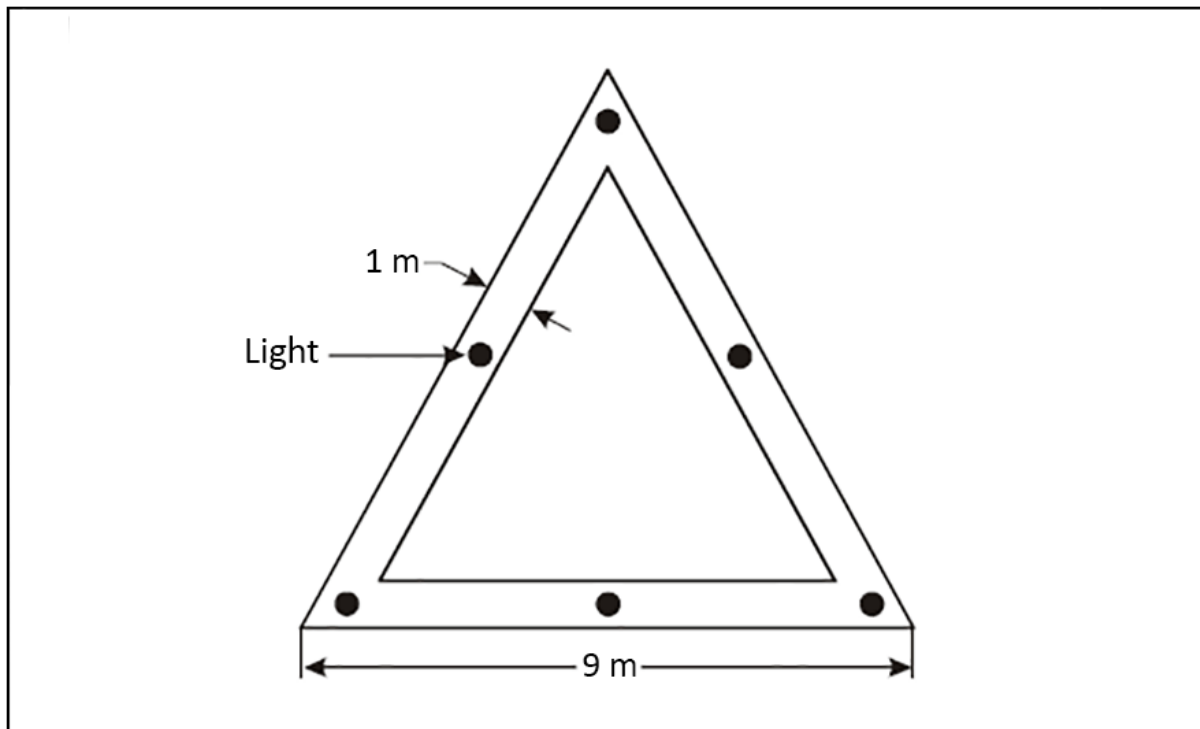


Figure F-12. Aiming point marking and lighting

**GM1 HPT-DSN.F.680 Aiming point lights**

ED Decision 2019/012/R

Intentionally left blank

**CS HPT-DSN.F.690 Touchdown and lift-off area lighting system**

ED Decision 2019/012/R

- (a) Applicability:
- (1) A TLOF lighting system should be provided at a heliport intended for use at night.
  - (2) The TLOF lighting system for a heliport should consist of one or more of the following:
    - (i) perimeter lights; or
    - (ii) floodlighting; or
    - (iii) ASPSL or LP lighting to identify the TLOF when (i) and (ii) are not practicable and FATO lights are available.
- (b) Location:
- (1) TLOF perimeter lights should be placed along the edge of the area designated for use as the TLOF or within a distance of 1.5 m from the edge.
  - (2) Where the TLOF is a circle, the lights should be:
    - (i) located on straight lines in a pattern which should provide information to pilots on drift displacement; or
    - (ii) evenly spaced around the perimeter of the TLOF at the appropriate intervals, sufficient to present the pattern, except that over a sector of 45 degrees, the lights should be spaced at half spacing.
  - (3) TLOF perimeter lights should be uniformly spaced at intervals of not more than 5 m.
  - (4) Where TLOF perimeter lights are located on straight lines, there should be a minimum number of four lights on each side, including a light at each corner.
  - (5) For a circular TLOF, where lights are installed in accordance with paragraph (2)(ii) above, there should be a minimum of fourteen lights.
  - (6) Where ASPSL or LPs are provided to identify the TLOF, which is not a circle, they should be placed along the marking designating the edge of the TLOF.
  - (7) Where ASPL or LPs are provided to identify the TLOF, which is a circle, they should be located on straight lines circumscribing the area.
  - (8) The minimum number of LPs on a TLOF should be nine.
  - (9) The total length of LPs in a pattern should not be less than 50 per cent of the length of the pattern.
  - (10) There should be an odd number of LPs with a minimum number of three panels on each side of the TLOF, including a panel at each corner.
  - (11) LPs should be uniformly spaced with a distance between adjacent panel ends of not more than 5 m on each side of the TLOF.
  - (12) TLOF floodlights should be located so as to avoid glare to pilots in flight or to personnel working on the area.

- (13) The arrangement and aiming of floodlights should be such that shadows are kept to a minimum.
- (c) Characteristics:
- (1) The TLOF perimeter lights should be fixed omnidirectional lights showing green.
  - (2) ASPSL or LPs should emit green light when used to define the perimeter of the TLOF.
  - (3) The chromaticity and luminance of colours of LPs should be in accordance with the specifications in [CS ADR-DSN.U.935](#).
  - (4) An LP should have a minimum width of 6 cm. The panel housing should be the same colour as the marking it defines.
  - (5) The perimeter lights should not exceed a height of 25 cm and should be inset when a light extending above the surface could endanger helicopter operations.
  - (6) When located within the safety area of a heliport, the TLOF floodlights should not exceed a height of 25 cm.
  - (7) The LPs should not extend above the surface by more than 2.5 cm.
  - (8) The light distribution of the perimeter lights should be as shown in Figure F-9, Illustration 5.
  - (9) The light distribution of the LPs should be as shown in Figure F-9, Illustration 6.
  - (10) The spectral distribution of TLOF area floodlights should be such that the surface and obstacle marking can be correctly identified.
  - (11) The average horizontal illuminance of the floodlighting should be at least 10 lux, with a uniformity ratio (average to minimum) of not more than 8:1 measured on the surface of the TLOF.
  - (12) The lighting used to identify the touchdown marking should comprise a segmented circle of omnidirectional ASPSL strips showing yellow. The segments should consist of ASPSL strips, and the total length of the ASPSL strips should not be less than 50 per cent of the circumference of the circle.
  - (13) If utilised, the heliport identification marking lighting should be omnidirectional showing green.

## **GM1 HPT-DSN.F.690 Touchdown and lift-off area lighting system**

*ED Decision 2019/012/R*

TLOF ASPSL and/or LPs to identify the touchdown marking and/or floodlighting should be provided for use at night when enhanced surface texture cues are required.

## **CS HPT-DSN.F.700 Taxiway lights**

*ED Decision 2019/012/R*

The specifications of [CS ADR-DSN.M.710](#), [CS ADR-DSN.M.715](#) and [CS ADR-DSN.M.720](#) are applicable to taxiways intended for ground taxiing of helicopters.

## GM1 HPT-DSN.F.700 Taxiway lights

ED Decision 2019/012/R

Intentionally left blank

## CS HPT-DSN.F.710 Visual aids for denoting obstacles

ED Decision 2019/012/R

Obstacles should be marked and lit in accordance with [CS ADR-DSN.Q.840](#), [CS ADR-DSN.Q.845](#) and [CS ADR-DSN.Q.850](#).

## GM1 HPT-DSN.F.710 Visual aids for denoting obstacles

ED Decision 2019/012/R

- (a) General: If it is not possible to display obstacle lights on obstacles at a heliport intended for use at night, the obstacles should be floodlit.
- (b) Location: Obstacle floodlights should be arranged so as to illuminate the entire obstacle and, as far as practicable, in a manner so as not to dazzle helicopter pilots.
- (c) Characteristics: Obstacle floodlighting should produce a luminance of at least 10 cd/m<sup>2</sup>.