

Easy Access Rules for Sailplanes

EASA eRules: aviation rules for the 21st century

Rules and regulations are the core of the European Union civil aviation system. The aim of the **EASA eRules** project is to make them **accessible** in an efficient and reliable way to stakeholders.

EASA eRules will be a comprehensive, single system for the drafting, sharing and storing of rules. It will be the single source for all aviation safety rules applicable to European airspace users. It will offer easy (online) access to all rules and regulations as well as new and innovative applications such as rulemaking process automation, stakeholder consultation, cross-referencing, and comparison with ICAO and third countries' standards.

To achieve these ambitious objectives, the **EASA eRules** project is structured in ten modules to cover all aviation rules and innovative functionalities.

The **EASA eRules** system is developed and implemented in close cooperation with Member States and aviation industry to ensure that all its capabilities are relevant and effective.

Published October 2020¹

Copyright notice

© European Union, 1998-2020

Except where otherwise stated, reuse of the EUR-Lex data for commercial or non-commercial purposes is authorised provided the source is acknowledged ('© European Union, <http://eur-lex.europa.eu/>, 1998-2020')².

Cover page picture: © kadawittfeldarchitektur

¹ The published date represents the date when the consolidated version of the document was generated.

² Euro-Lex, Important Legal Notice: <http://eur-lex.europa.eu/content/legal-notice/legal-notice.html>.

DISCLAIMER

This version is issued by the European Union Aviation Safety Agency (EASA) in order to provide its stakeholders with an updated and easy-to-read publication related to sailplanes. It has been prepared by putting together the officially published regulations with the related acceptable means of compliance and guidance material (including the amendments) adopted so far and certification specifications and acceptable means of compliance and guidance material. However, this is not an official publication and EASA accepts no liability for damage of any kind resulting from the risks inherent in the use of this document.

NOTE FROM THE EDITOR

The content of this document is arranged as follows: the cover regulation (recitals and articles) of the implementing rule (IR) appear first, then the IR annex points, followed by the related acceptable means of compliance (AMC) and guidance material (GM) paragraph(s).

In case of certification specifications (CS), a CS paragraph is followed by the related AMC paragraph.

All elements (i.e. cover regulation, IRs, CS, AMC and GM) are colour-coded and can be identified according to the illustration below. The Commission regulation or EASA Executive Director (ED) decision through which the point or paragraph was introduced or last amended is indicated below the point or paragraph title(s) *in italics*.

<u>Cover regulation article</u>	<i>Commission regulation</i>
Implementing rule annex	<i>Commission regulation</i>
Certification specification	<i>ED decision</i>
Acceptable means of compliance	<i>ED decision</i>
Guidance material	<i>ED decision</i>

This document will be updated regularly to incorporate further amendments.

The format of this document has been adjusted to make it user-friendly and for reference purposes. Any comments should be sent to erules@easa.europa.eu.

INCORPORATED AMENDMENTS

IMPLEMENTING RULES (IRs) (COMMISSION REGULATIONS)

Incorporated Commission Regulation	Affected Part	Domain	Applicability date ¹
Regulation (EU) 2018/1976	Cover regulation	Air operations	9/7/2019
	Annex I — Definitions (Part-DEF)		
	Annex II — Sailplane air operations (Part-SAO)		
Regulation (EU) 2020/358	Cover regulation	Air operations and Aircrew	8/4/2020
	Annex I — Definitions (Part-DEF)		
	Annex II — Sailplane air operations (Part-SAO)		
	Annex III — Requirements for Sailplanes Flight Crew Licensing (Part-SFCL)		

AMC/GM TO IR (ED DECISIONS)

Incorporated ED Decision	Affected AMC/GM	Issue/ Amendment No	Applicability date
ED Decision 2019/001/R	Annex I — GM to Cover regulation	Initial issue	9/7/2019
	Annex II — AMC and GM to Annex II Sailplane Air Operations (Part-SAO)		
ED Decision 2020/004/R	AMC and GM to Annex III (Part-SFCL)	Issue 1	8/4/2020

CS/AMC (ED DECISIONS)

Incorporated ED Decision	CS/AMC Issue No, Amendment No	Applicability date
ED Decision 2003/13/RM	CS-22/ Initial issue	14/11/2003
ED Decision 2008/008/R	CS-22/ Amendment 1	1/10/2008
ED Decision 2009/009/R	CS-22/ Amendment 2	5/3/2009

Note: To access the official source documents, please use the links provided above.

¹ This date is the earliest applicability date for this regulation. Some provisions of the regulation may be applicable at a later date. Besides, there may be some opt-out filed by the Member States.

TABLE OF CONTENTS

Disclaimer	3
Note from the editor	4
Incorporated amendments	5
Table of contents	6
Chapter 1 — Air operations and Licensing	19
Cover regulation	19
Article 1 - Subject matter and scope	20
Article 2 - Definitions.....	20
Article 3 - Air operations	21
GM1 to Article 3(2)(a);(b) Air operations	22
GM2 to Article 3(2)(a);(b) Air operations	22
GM1 to Article 3(2)(c) Air operations	22
GM2 to Article 3(2)(c) Air operations	22
Article 3a - Pilot licences and medical certification	23
Article 3b - Existing pilot licences and national medical certificates	23
Article 3c - Credit for training that commenced prior to the date of application of this Regulation	24
Article 3d - Training organisations	24
Article 4 - Entry into force and application	25
ANNEX I	26
DEFINITIONS (Part-DEF)	26
FCL.010 Definitions related to Part-SFCL	28
ANNEX II — SAILPLANE AIR OPERATIONS (Part-SAO)	29
SUBPART GEN – GENERAL REQUIREMENTS	29
SAO.GEN.100 Scope	29
SAO.GEN.105 Competent authority.....	29
SAO.GEN.110 Demonstration of compliance.....	29
AMC1 SAO.GEN.110(a) Demonstration of compliance	29
GM1 SAO.GEN.110(b)(2) Demonstration of compliance.....	30
SAO.GEN.115 Introductory flights.....	30
SAO.GEN.120 Immediate reaction to a safety problem	30
SAO.GEN.125 Designation of the pilot-in-command	30
SAO.GEN.130 Responsibilities of the pilot-in-command	30
AMC1 SAO.GEN.130(c) Responsibilities of the pilot-in-command	32
AMC1 SAO.GEN.130(d)(4) Responsibilities of the pilot-in-command	32
AMC1 SAO.GEN.130(f) Responsibilities of the pilot-in-command.....	32
AMC1 SAO.GEN.130(f) & SAO.GEN.135(b) Responsibilities of the pilot-in-command & responsibilities of crew members	32
AMC1 SAO.GEN.130(p) Responsibilities of the pilot-in-command.....	32
GM1 SAO.GEN.130(a);(b) Responsibilities of the pilot-in-command	33

GM1 SAO.GEN.130(f) Responsibilities of the pilot-in-command	33
GM1 SAO.GEN.130(f) & SAO.GEN.135(b) Responsibilities of the pilot-in-command & responsibilities of crew members.....	33
GM1 SAO.GEN.130(m) Responsibilities of the pilot-in-command.....	33
GM2 SAO.GEN.130(m) Responsibilities of the pilot-in-command.....	34
SAO.GEN.135 Responsibilities of crew members	34
GM1 SAO.GEN.135 Responsibilities of crew members	34
SAO.GEN.140 Compliance with laws, regulations and procedures	35
SAO.GEN.145 Portable electronic devices	35
GM1 SAO.GEN.145 Portable electronic devices	35
GM2 SAO.GEN.145 Portable electronic devices	35
SAO.GEN.150 Dangerous goods.....	36
AMC1 SAO.GEN.150(b) Dangerous goods	36
GM1 SAO.GEN.150 Dangerous goods	37
SAO.GEN.155 Documents, manuals and information to be carried	37
AMC1 SAO.GEN.155 Documents, manuals and information to be carried	38
AMC1 SAO.GEN.155(a)(3) Documents, manuals and information to be carried	38
AMC1 SAO.GEN.155(c)(2) Documents, manuals and information to be carried	39
GM1 SAO.GEN.155(a)(1) Documents, manuals and information to be carried	39
GM1 SAO.GEN.155(a)(4) Documents, manuals and information to be carried	39
GM1 SAO.GEN.155(a)(5) Documents, manuals and information to be carried	39
GM1 SAO.GEN.155(c)(7) Documents, manuals and information to be carried.....	40
SAO.GEN.160 Journey log	40
AMC1 SAO.GEN.160 Journey log	40
SUBPART OP – OPERATING PROCEDURES.....	41
SAO.OP.100 Use of aerodromes and operating sites	41
GM1 SAO.OP.100 Use of aerodromes and operating sites	41
SAO.OP.105 Noise abatement procedures – powered sailplanes	41
SAO.OP.110 Passenger briefing	41
AMC1 SAO.OP.110 Passenger briefing	41
GM1 SAO.OP.110 Passenger briefing	41
SAO.OP.115 Carriage of special categories of passengers.....	42
SAO.OP.120 Flight preparation	42
GM1 SAO.OP.120(a) Flight preparation.....	42
SAO.OP.125 Refuelling and recharging or replacing of batteries with persons on board – powered sailplanes	42
SAO.OP.130 Smoking on board.....	42
SAO.OP.135 Meteorological conditions.....	42
GM1 SAO.OP.135 Meteorological conditions.....	43
SAO.OP.140 Ice and other contaminants – ground procedures.....	43
SAO.OP.145 In-flight fuel or other energy management – powered sailplanes....	43
GM1 SAO.OP.145 In-flight fuel or other energy management – powered sailplanes	43
SAO.OP.150 Use of supplemental oxygen	43
AMC1 SAO.OP.150 Use of supplemental oxygen	44
SAO.OP.155 Sailplane specialised operations.....	44
AMC1 SAO.OP.155 Sailplane specialised operations.....	44
AMC1 SAO.OP.155(b) Sailplane specialised operations	44
AMC2 SAO.OP.155(b) Sailplane specialised operations	45
GM1 SAO.OP.155 Sailplane specialised operations.....	45
GM2 SAO.OP.155 Sailplane specialised operations.....	45
GM1 SAO.OP.155(b) Sailplane specialised operations	46

SUBPART POL – PERFORMANCE AND OPERATING LIMITATIONS	47
SAO.POL.100 Weighing	47
GM1 POL.100 Weighing.....	47
SAO.POL.105 Performance – general.....	47
SUBPART IDE – INSTRUMENTS, DATA AND EQUIPMENT	48
SAO.IDE.100 Instruments and equipment – general	48
GM1 SAO.IDE.100 Instruments and equipment – general	48
GM1 SAO.IDE.100(a)(3) Instruments and equipment – general	48
SAO.IDE.105 Flight and navigational instruments	48
AMC1 SAO.IDE.105 Flight and navigational instruments	49
AMC1 SAO.IDE.105(a)(1) Flight and navigational instruments.....	49
AMC1 SAO.IDE.105(a)(2) Flight and navigational instruments.....	49
AMC1 SAO.IDE.105(a)(3) Flight and navigational instruments.....	49
AMC1 SAO.IDE.105(a)(4);(b)(3) Flight and navigational instruments.....	50
GM1 SAO.IDE.105(b) Flight and navigational instruments.....	50
SAO.IDE.110 Operating lights.....	50
SAO.IDE.115 Supplemental oxygen.....	50
SAO.IDE.120 Life-saving and signalling equipment – flights over water	50
AMC1 SAO.IDE.120 Life-saving and signalling equipment – flights over water	51
AMC2 SAO.IDE.120 Life-saving and signalling equipment – flights over water	51
AMC3 SAO.IDE.120 Life-saving and signalling equipment – flights over water	51
GM1 SAO.IDE.120 Life-saving and signalling equipment – flights over water	52
AMC4 SAO.IDE.120 Life-saving and signalling equipment – flights over water	52
SAO.IDE.125 Life-saving and signalling equipment – search and rescue difficulties	52
AMC1 SAO.IDE.125 Life-saving and signalling equipment – search and rescue difficulties	52
GM1 SAO.IDE.125 Life-saving and signalling equipment – search and rescue difficulties	53
GM2 SAO.IDE.125 Life-saving and signalling equipment – search and rescue difficulties	53
SAO.IDE.130 Radio communication equipment	53
AMC1 SAO.IDE.130 Radio communication equipment	53
SAO.IDE.135 Transponder.....	53
GM1 SAO.IDE.135 Transponder.....	54
SUBPART DEC – DECLARATION	55
SAO.DEC.100 Declaration.....	55
GM1 SAO.DEC.100 Declaration	55
SAO.DEC.105 Changes to the declaration and cessation of commercial operations	55
AMC1 SAO.DEC.105(a) Changes to the declaration and cessation of commercial operations.....	56
Appendix	57
ANNEX III – REQUIREMENTS FOR SAILPLANE FLIGHT CREW LICENSING (Part-SFCL)	58
SUBPART GEN – GENERAL REQUIREMENTS.....	58
SFCL.001 Scope.....	58
GM1 SFCL.001 Scope	58
SFCL.005 Competent authority	58

SFCL.015 Application for and issue, revalidation and renewal of an SPL as well as associated privileges, ratings and certificates	58
AMC1 SFCL.015 Application for and issue, revalidation and renewal of an SPL as well as associated privileges, ratings and certificates.....	59
SFCL.030 Practical skill test	59
SFCL.035 Crediting of flight time.....	59
SFCL.045 Obligation to carry and present documents.....	60
AMC1 SFCL.045(a)(4) Obligation to carry and present documents	60
SFCL.050 Recording of flight time	60
AMC1 SFCL.050 Recording of flight time	60
SFCL.065 Curtailment of privileges of SPL holders aged 70 years or older in commercial passenger sailplane operations.....	61
SFCL.070 Limitation, suspension and revocation of licences, privileges, ratings and certificates.....	62
SUBPART SPL – SAILPLANE PILOT LICENCE ('SPL')	63
SFCL.115 SPL – Privileges and conditions.....	63
AMC1 SFCL.115(a)(2)(ii)(A) SPL – Privileges and conditions	63
SFCL.120 SPL – Minimum age	64
SFCL.125 SPL – Student pilot	64
SFCL.130 SPL – Training course and experience requirements	64
AMC1 SFCL.130 SPL – Training course and experience requirements.....	65
AMC2 SFCL.130 SPL – Training course and experience requirements.....	67
AMC3 SFCL.130 SPL – Training course and experience requirements.....	75
GM1 SFCL.130(a)(2)(iv) SPL – Training course and experience requirements.....	76
SFCL.135 SPL – Theoretical knowledge examination	76
AMC1 SFCL.135 SPL – Theoretical knowledge examinations	77
GM1 SFCL.135 SPL – Theoretical knowledge examinations	78
SFCL.140 SPL – Crediting of theoretical knowledge.....	78
SFCL.145 SPL – Practical skill test	78
AMC1 SFCL.145 SPL – Practical skill test.....	79
SFCL.150 SPL – Sailplane and TMG privileges	82
AMC1 SFCL.150(b) SPL – Sailplane and TMG privileges.....	83
GM1 SFCL.150(c) SPL – Sailplane and TMG privileges	92
AMC1 SFCL.150(e) SPL – Sailplane and TMG privileges.....	92
SFCL.155 SPL – Launching methods	93
AMC1 SFCL.155(a)(2) SPL – Launching methods	93
GM1 SFCL.155(a)(4) SPL – Launching methods	94
SFCL.160 SPL – Recency requirements.....	94
AMC1 SFCL.160 SPL – Recency requirements	95
AMC1 SFCL.160(a)(1)(ii) SPL – Recency requirements.....	95
AMC1 SFCL.160(e) Recency requirements	95
SUBPART ADD – ADDITIONAL RATINGS AND PRIVILEGES	96
SFCL.200 Aerobatic privileges	96
AMC1 SFCL.200(b) Aerobatic privileges.....	97
AMC1 SFCL.200(c) Aerobatic privileges.....	98
AMC1 SFCL.200(d) Aerobatic privileges.....	99
AMC1 SFCL.200(e) Aerobatic privileges.....	99
SFCL.205 Sailplane towing and banner towing rating.....	99
AMC1 SFCL.205 Sailplane towing and banner towing rating.....	100
SFCL.210 TMG night rating.....	102
AMC1 SFCL.210 TMG night rating.....	103

SFCL.215 Sailplane cloud flying privileges	104
AMC1 SFCL.215 Sailplane cloud flying privileges	105
SUBPART FI – FLIGHT INSTRUCTORS	108
Section 1 – General requirements	108
SFCL.300 Flight instructor certificate	108
Section 2 – Flight instructor certificate for sailplanes – FI(S).....	109
SFCL.315 FI(S) certificate – Privileges and conditions	109
AMC1 SFCL.315(a)(7)(ii) FI(S) certificate – Privileges and conditions	110
SFCL.320 FI(S) certificate – Prerequisites and requirements	110
SFCL.325 FI(S) competencies and assessment	110
AMC1 SFCL.325 FI(S) competencies and assessment	111
SFCL.330 FI(S) – Training course.....	112
AMC1 SFCL.330(a) FI(S) – Training course	112
AMC1 SFCL.330(b) FI(S) – Training course	112
SFCL.345 FI(S) – Assessment of competence	135
AMC1 SFCL.345 FI(S) – Assessment of competence	135
AMC2 SFCL.345 FI(S) – Assessment of competence	136
AMC3 SFCL.345 FI(S) – Assessment of competence	137
SFCL.350 FI(S) – Restricted privileges.....	139
SFCL.360 FI(S) certificate – Recency requirements.....	139
AMC1 SFCL.360(a)(1)(i) FI(S) certificate – Recency requirements.....	140
GM1 SFCL.360(a)(1)(i) FI(S) certificate – Recency requirements.....	141
AMC1 SFCL.360(a)(2) FI(S) certificate – Recency requirements	141
SUBPART FE – FLIGHT EXAMINERS.....	142
Section 1 – General requirements	142
SFCL.400 Sailplane flight examiner certificates.....	142
SFCL.405 Limitation of privileges in case of vested interests	143
GM1 SFCL.405 Limitation of privileges in case of vested interests	143
GM1 SFCL.405(a) Limitation of privileges in case of vested interests	143
SFCL.410 Conduct of skill tests, proficiency checks and assessments of competence	143
AMC1 SFCL.410(b)(3) Conduct of skill tests, proficiency checks and assessments of competence	145
Section 2 – Flight examiner certificate for sailplanes – FE(S).....	147
SFCL.415 FE(S) certificate – Privileges and conditions	147
AMC1 SFCL.415(c)(2) FE(S) certificate – Privileges and conditions.....	147
SFCL.420 FE(S) certificate – Prerequisites and requirements	148
AMC1 SFCL.420(d) FE(S) certificate – Prerequisites and requirements.....	148
SFCL.430 FE(S) certificate – Standardisation course	148
AMC1 SFCL.430 FE(S) certificate – Standardisation course	149
AMC2 SFCL.430 FE(S) certificate – Standardisation course	150
GM1 SFCL.430 FE(S) certificate – Standardisation course	153
SFCL.445 FE(S) certificate – Assessment of competence	153
AMC1 SFCL.445 FE(S) certificate – Assessment of competence	153
SFCL.460 FE(S) certificate – Validity, revalidation and renewal.....	155
AMC1 SFCL.445; SFCL.460 FE(S) certificate – Assessment of competence; FE(S) certificate – Validity, revalidation and renewal.....	156
AMC1 SFCL.460(b)(1) FE(S) certificate – Validity, revalidation and renewal	157
AMC1 SFCL.460(b)(2) FE(S) certificate – Validity, revalidation and renewal	157

Chapter 2 – Continuing airworthiness **158**

Chapter 3 — Initial airworthiness	159
CS-22.....	159
Preamble	159
Subpart A — General	160
CS 22.1 Applicability	160
AMC 22.1(a) Applicability	160
Appendix I – Self-sustaining powered sailplanes	161
CS 22.3 Sailplane categories.....	161
AMC 22.3 Sailplane categories	162
Appendix F – Glossary of aerobatic manoeuvres.....	162
Appendix K – Aerotowing of Sailplanes by Powered Sailplanes	164
AMC 22 - Appendix K paragraph 1.1.....	167
Subpart B — Flight	168
GENERAL.....	168
CS 22.21 Proof of compliance	168
AMC 22.21 Proof of compliance	168
CS 22.23 Load distribution limits.....	169
AMC 22.23 Load distribution limits	169
CS 22.25 Weight limits	169
CS 22.29 Empty weight and corresponding c.g.....	170
CS 22.31 Ballast	170
PERFORMANCE	171
CS 22.45 General	171
CS 22.49 Stalling speed	171
CS 22.51 Take-off	172
CS 22.65 Climb.....	172
CS 22.71 Rate of descent.....	172
CS 22.73 Descent, high speed	172
CS 22.75 Descent, approach.....	173
CONTROLLABILITY AND MANOEUVRABILITY	174
CS 22.143 General	174
AMC 22.143(a) Controllability and Manoeuvrability	174
AMC 22.143(b) Controllability and Manoeuvrability.....	174
CS 22.145 Longitudinal control	175
CS 22.147 Lateral and directional control	175
CS 22.151 Aerotowing.....	175
AMC 22.151(c)(3) Aerotowing	176
CS 22.152 Winch-launching and auto-tow launching	176
AMC 22.152 Winch-launching and auto-tow launching	177
CS 22.153 Approach and landing	177
CS 22.155 Elevator control force in manoeuvres.....	177
TRIM.....	178
CS 22.161 Trim	178
STABILITY.....	179
CS 22.171 General	179
CS 22.173 Static longitudinal stability	179
AMC 22.173(a)(1) Static longitudinal stability	179
AMC 22.173(b) Static longitudinal stability	179

CS 22.175 Demonstration of static longitudinal stability.....	180
AMC 22.175 Demonstration of static longitudinal stability.....	181
CS 22.177 Lateral and directional stability.....	181
CS 22.181 Dynamic stability.....	181
STALLS	182
CS 22.201 Wings level stall.....	182
AMC 22.201(c) Wings level stall.....	182
AMC 22.201(d) Wings level stall.....	183
CS 22.203 Turning flight stalls.....	183
CS 22.207 Stall warning.....	183
AMC 22.207(b) Stall warning.....	184
SPINNING.....	185
CS 22.221 General.....	185
AMC 22.221(b) Spinning.....	185
AMC 22.221(c),(d),(e) and (f) Spinning.....	186
CS 22.223 Spiral dive characteristics.....	186
GROUND HANDLING CHARACTERISTICS	187
CS 22.233 Directional stability and control.....	187
MISCELLANEOUS FLIGHT REQUIREMENTS	188
CS 22.251 Vibration and buffeting.....	188
CS 22.255 Aerobatic manoeuvres.....	188
AMC 22.255(a) Aerobatic manoeuvres.....	188
Subpart C — Structure.....	189
GENERAL.....	189
CS 22.301 Loads.....	189
CS 22.303 Factor of safety.....	189
CS 22.305 Strength and deformation.....	189
CS 22.307 Proof of structure.....	189
AMC 22.307(a) Proof of structure.....	189
FLIGHT LOADS	190
CS 22.321 General.....	190
AMC 22.321(b) Flight loads.....	190
CS 22.331 Symmetrical flight conditions.....	190
CS 22.333 Flight envelope.....	190
CS 22.335 Design air speeds.....	192
AMC 22.335 Design air speeds.....	193
CS 22.337 Limit manoeuvring load factors.....	193
CS 22.341 Gust load factors.....	194
CS 22.345 Loads with air brakes and wing-flaps extended.....	194
CS 22.347 Unsymmetrical flight conditions.....	195
AMC 22.347 Unsymmetrical flight conditions.....	195
CS 22.349 Rolling conditions.....	195
CS 22.351 Yawing conditions.....	195
CS 22.361 Engine torque.....	196
CS 22.363 Side load on engine mount.....	196
CS 22.371 Gyroscopic Loads.....	196
CS 22.375 Winglets.....	196
AMC 22.375(a) Winglets.....	197
CONTROL SURFACES AND SYSTEMS	198
CS 22.395 Control system loads.....	198
CS 22.397 Loads resulting from limit pilot forces.....	198

CS 22.399 Dual control systems	198
CS 22.405 Secondary control systems.....	198
AMC 22.405 Secondary control systems	199
CS 22.411 Control system stiffness and stretch.....	199
AMC 22.411(a) Control system stiffness and stretch	199
CS 22.415 Ground gust conditions	199
HORIZONTAL TAIL SURFACES	201
CS 22.421 Balancing loads.....	201
CS 22.423 Manoeuvring loads.....	201
AMC 22.423 Manoeuvring loads	201
CS 22.425 Gust loads.....	203
CS 22.427 Unsymmetrical loads for powered sailplanes	203
VERTICAL TAIL SURFACES.....	204
CS 22.441 Manoeuvring loads.....	204
AMC 22.441 Vertical tail surfaces.....	204
CS 22.443 Gust loads.....	204
AMC 22.443 Vertical tail surfaces.....	205
SUPPLEMENTARY CONDITIONS FOR TAIL SURFACES	205
CS 22.447 Combined loads on tail surfaces	205
AMC 22.447(a) Combined loads on tail surfaces.....	205
CS 22.449 Additional loads applicable to V-tails.....	206
AILERONS.....	207
CS 22.455 Ailerons.....	207
GROUND LOADS.....	208
CS 22.471 General	208
CS 22.473 Ground load conditions and assumptions.....	208
CS 22.477 Landing gear Arrangement.....	208
AMC 22.477 Landing gear arrangement.....	208
CS 22.479 Level landing condition	209
CS 22.481 Tail-down landing conditions	209
AMC 22.481 Tail-down landing conditions	209
CS 22.483 One-wheel landing condition	210
CS 22.485 Side load conditions	210
CS 22.497 Tail skid impact.....	210
CS 22.499 Supplementary conditions for nose wheels.....	210
CS 22.501 Wing-tip landing	211
EMERGENCY LANDING CONDITIONS	212
CS 22.561 General	212
AMC 22.561 Emergency Landing Conditions - General	212
AMC 22.561(b)(2) Emergency Landing Conditions	214
TOWING AND LAUNCHING LOADS	216
CS 22.581 Aerotowing.....	216
CS 22.583 Winch-launching.....	216
CS 22.585 Strength of launching hook attachment	216
OTHER LOADS	218
CS 22.591 Rigging and de-rigging loads	218
CS 22.593 Hand forces at the horizontal tail surfaces	218
CS 22.595 Load on the attachment point of the parachute ripcord.....	218
CS 22.597 Loads from single masses.....	218
Subpart D — Design and Construction	219

GENERAL	219
CS 22.601 General	219
CS 22.603 Materials.....	219
CS 22.605 Fabrication methods	219
CS 22.607 Locking of connections.....	219
CS 22.609 Protection of structure.....	219
CS 22.611 Accessibility	220
AMC 22.611 Accessibility.....	220
CS 22.612 Provisions for rigging and derigging	220
CS 22.613 Material strength properties and design values	220
AMC 22.613(b) Material strenght properties and design values.....	220
AMC 22.613(c) Material strenght properties and design values.....	221
CS 22.619 Special factors	221
AMC 22.619(a) Special factors.....	221
CS 22.621 Casting factors	221
CS 22.623 Bearing factors	221
CS 22.625 Fitting factors	222
CS 22.627 Fatigue strength	222
CS 22.629 Flutter	222
CONTROL SURFACES	224
CS 22.655 Installation.....	224
CS 22.657 Hinges.....	224
CS 22.659 Mass balance.....	224
CONTROL SYSTEMS	225
CS 22.671 General	225
CS 22.675 Stops.....	225
CS 22.677 Trim system.....	225
CS 22.679 Control system locks	225
CS 22.683 Operation tests.....	225
CS 22.685 Control system details.....	226
AMC 22.685(d) Control system details	226
CS 22.687 Spring devices.....	226
CS 22.689 Cable systems.....	226
AMC 22.689(b) Cable systems	227
CS 22.693 Joints.....	227
CS 22.697 Wing-flap and air-brake controls	227
CS 22.699 Wing-flap position indicator.....	228
CS 22.701 Wing-flap interconnection	228
CS 22.711 Release mechanisms	228
CS 22.713 Launching hook	228
LANDING GEAR	230
CS 22.721 General	230
CS 22.723 Shock absorption test.....	230
AMC 22.723 Shock absorption test	230
CS 22.725 Level landing.....	230
CS 22.729 Retracting mechanism.....	230
CS 22.731 Wheels and tyres.....	231
COCKPIT DESIGN	232
CS 22.771 General	232
CS 22.773 Cockpit view	232
AMC 22.773(b) Cockpit view	232

CS 22.775	Windshields and windows.....	232
AMC 22.775(a)	Windshields and windows	232
CS 22.777	Cockpit controls.....	232
AMC 22.777(a)	Cockpit controls	233
AMC 22.777(c)	Cockpit controls	233
AMC 22.777(d)	Cockpit controls.....	233
CS 22.779	Motion and effect of cockpit controls.....	233
CS 22.780	Colour marking and arrangement of cockpit controls	234
AMC 22.780	Color marking and arrangement of cockpit controls	234
CS 22.781	Cockpit control knob shape.....	234
AMC 22.781	Cockpit control knob shape	234
CS 22.785	Seats and safety harnesses	234
AMC 22.785(f)	Seats and safety harnesses.....	235
Appendix J	– Process of H-point determination	236
CS 22.786	Protection from injury.....	238
CS 22.787	Baggage compartment	238
CS 22.788	Headrests.....	238
AMC 22.788	Headrests	238
CS 22.807	Emergency exit	238
AMC 22.807(a)	Emergency Exits	239
CS 22.831	Ventilation	239
CS 22.857	Electrical bonding	240
CS 22.881	Ground handling.....	240
CS 22.883	Ground clearance	240
CS 22.885	Fairings	240
CS 22.891	Water ballast tanks: general	240
CS 22.892	Water ballast tank: tests	240
CS 22.893	Water ballast tank installation	240
CS 22.894	Water ballast tank vents	241
CS 22.895	Water ballast system.....	241
AMC 22.895(a)	Water ballast	241
CS 22.896	Water ballast drains	241
CS 22.897	Water ballast additives.....	241
Subpart E	— Power-plant.....	242
GENERAL	242
CS 22.901	Installation.....	242
CS 22.902	Installation: sailplanes with retractable power-plants or propellers.....	242
CS 22.903	Engines	242
CS 22.905	Propellers	242
CS 22.925	Propeller clearance.....	243
FUEL SYSTEM	244
CS 22.951	General	244
CS 22.955	Fuel flow	244
CS 22.959	Unusable fuel.....	244
CS 22.963	Fuel tanks: general	244
CS 22.965	Fuel tank tests	244
CS 22.967	Fuel tank installation	245
CS 22.969	Fuel tank expansion space	245
CS 22.971	Fuel tank sump	245
CS 22.973	Fuel tank filler connection.....	246

CS 22.975 Fuel tank vents	246
CS 22.977 Fuel strainer or filter.....	246
CS 22.993 Fuel system lines and fittings	246
CS 22.995 Fuel valves and controls	246
OIL SYSTEM	248
CS 22.1011 General	248
CS 22.1013 Oil tanks.....	248
CS 22.1015 Oil tank tests.....	248
CS 22.1017 Oil lines and fittings.....	248
COOLING.....	249
CS 22.1041 General	249
CS 22.1047 Cooling test procedure for reciprocating engine powered sailplanes	249
INDUCTION SYSTEM	250
CS 22.1091 Air induction	250
CS 22.1093 Induction system icing protection.....	250
CS 22.1103 Induction system ducts	250
CS 22.1105 Induction system screens.....	250
EXHAUST SYSTEM.....	251
CS 22.1121 General	251
CS 22.1125 Exhaust manifold.....	251
POWER-PLANT CONTROLS AND ACCESSORIES	252
CS 22.1141 General	252
CS 22.1145 Ignition switches.....	252
CS 22.1149 Propeller speed and pitch controls	252
CS 22.1163 Power-plant accessories.....	253
CS 22.1165 Engine ignition systems	253
POWER-PLANT FIRE PROTECTION	254
CS 22.1191 Firewalls.....	254
AMC 22.1191(c) Firewalls	254
CS 22.1193 Cowling and nacelle.....	254
Subpart F — Equipment	255
GENERAL.....	255
CS 22.1301 Function and installation.....	255
AMC 22.1301(a)(4) Function and installation.....	255
CS 22.1303 Flight and navigation instruments.....	255
CS 22.1305 Power-plant instruments	255
AMC 22.1305(i) Power-plant instruments.....	256
CS 22.1307 Miscellaneous equipment	256
INSTRUMENTS: INSTALLATION	257
CS 22.1321 Arrangement and visibility	257
AMC 22.1321 Arrangement and visibility	257
CS 22.1322 Warning, caution, and advisory lights.....	257
CS 22.1323 Air-speed indicating system	257
CS 22.1325 Static pressure system.....	257
CS 22.1327 Magnetic direction indicator.....	258
CS 22.1337 Power-plant instruments	258
ELECTRICAL SYSTEMS AND EQUIPMENT	259
CS 22.1353 Storage battery design and installation	259
CS 22.1361 Master switch arrangement.....	259

CS 22.1365 Electric cables and equipment	259
AMC 22.1365(c) Electric cables and equipment	259
CS 22.1385 External lights	259
MISCELLANEOUS EQUIPMENT	260
CS 22.1431 ATC airborne equipment	260
CS 22.1441 Oxygen equipment and supply	260
CS 22.1449 Means for determining use of oxygen	260
Subpart G — Operating Limitations and Information	261
GENERAL	261
CS 22.1501 General	261
CS 22.1505 Air-speed limitations	261
AMC 22.1505(a) Air-speed limitation	261
CS 22.1507 Manoeuvring speed	261
CS 22.1511 Wing-flap operating speed	261
CS 22.1513 Powerplant extension and retraction speed	261
CS 22.1514 Powerplant extended maximum permitted speed	262
CS 22.1515 Landing gear operating speed	262
CS 22.1517 Rough air speed	262
CS 22.1518 Aerotow and winch-launching speeds	262
CS 22.1519 Weight and c.g.	262
CS 22.1521 Power-plant limitations	262
CS 22.1523 Solo flight operation	263
CS 22.1525 Kinds of operation	263
CS 22.1529 Maintenance manual	263
MARKINGS AND PLACARDS	265
CS 22.1541 General	265
CS 22.1543 Instrument markings – general	265
CS 22.1545 Air-speed indicator	265
AMC 22.1545(a) Air-speed indicator	266
AMC 22.1545 Air-speed indicator	266
CS 22.1547 Magnetic direction indicator	266
CS 22.1548 Accelerometer	267
CS 22.1549 Power-plant instruments	267
AMC 22.1549(d) Power-plant instruments	267
CS 22.1553 Fuel quantity indicator	267
CS 22.1555 Control markings	267
AMC 22.1555(a) Control markings	268
Appendix G – Cockpit placards	268
CS 22.1557 Miscellaneous marking and placards	272
CS 22.1561 Safety equipment	272
CS 22.1563 Airspeed placards	273
FLIGHT MANUAL	274
CS 22.1581 General	274
AMC 22.1581 Flight manual	274
CS 22.1583 Operating limitations	303
AMC 22.1583(a) Operating limitations	304
CS 22.1585 Operating data and procedures	304
AMC 22.1585(f) Operating data and procedures	305
CS 22.1587 Performance information	305
CS 22.1589 Loading information	305

Subpart H — Engines	306
GENERAL	306
CS 22.1801 Applicability.....	306
AMC 22.1801 Applicability.....	306
CS 22.1805 Instruction manual	306
CS 22.1807 Engine ratings and operating limitations	306
CS 22.1808 Selection of engine power ratings.....	306
DESIGN AND CONSTRUCTION	307
CS 22.1815 Materials	307
CS 22.1817 Fire prevention	307
CS 22.1819 Durability.....	307
CS 22.1821 Engine cooling	307
CS 22.1823 Engine mounting attachments and structure	307
AMC 22.1823(a) Engine mounting attachments and structure	307
CS 22.1825 Accessory attachment	308
CS 22.1833 Vibration.....	308
CS 22.1835 Fuel and induction system	308
CS 22.1839 Lubrication system (four-stroke engines only).....	308
BENCH TESTS	309
CS 22.1843 Vibration test.....	309
AMC 22.1843 Vibration test	309
CS 22.1845 Calibration test	309
CS 22.1847 Detonation test (spark ignition only)	309
CS 22.1849 Endurance test	309
CS 22.1851 Operation test	310
CS 22.1853 Engine component test	310
CS 22.1855 Teardown inspection.....	310
CS 22.1857 Engine adjustment and parts replacement.....	310
Subpart J — Propellers	311
GENERAL	311
CS 22.1901 Applicability.....	311
AMC 22.1901 Applicability.....	311
CS 22.1903 Instruction manual	311
CS 22.1905 Propeller operating limitations	311
DESIGN AND CONSTRUCTION	312
CS 22.1917 Materials	312
CS 22.1919 Durability.....	312
CS 22.1923 Pitch Control.....	312
TESTS AND INSPECTIONS	313
CS 22.1933 General.....	313
CS 22.1935 Blade retention test	313
CS 22.1937 Vibration load limit test.....	313
CS 22.1939 Endurance test	313
CS 22.1941 Functional tests	314
CS 22.1945 Teardown inspection.....	314
CS 22.1947 Propeller adjustments and parts replacement	314

CHAPTER 1 — AIR OPERATIONS AND LICENSING

COVER REGULATION

Regulation (EU) 2018/1976

THE EUROPEAN COMMISSION,

Having regard to the Treaty on the Functioning of the European Union,

Having regard to Regulation (EU) 2018/1139 of the European Parliament and of the Council of 4 July 2018 on common rules in the field of civil aviation and establishing a European Union Aviation Safety Agency, and amending Regulations (EC) No 2111/2005, (EC) No 1008/2008, (EU) No 996/2010, (EU) No 376/2014 and Directives 2014/30/EU and 2014/53/EU of the European Parliament and of the Council, and repealing Regulations (EC) No 552/2004 and (EC) No 216/2008 of the European Parliament and of the Council and Council Regulation (EEC) No 3922/91¹, and in particular Article 31 thereof,

Whereas:

- (1) The Commission is to adopt the necessary implementing rules for establishing the conditions for the safe operation of sailplanes in accordance with Regulation (EU) 2018/1139, where such aircraft meet the conditions specified in points (b)(i) and (ii) of Article 2(1) of that Regulation.
- (2) In light of the specific nature of operations with sailplanes, there is a need for dedicated operational rules, laid down in a self-standing regulation. Those rules should be based on the general rules for air operations laid down in Commission Regulation (EU) No 965/2012², but they should be restructured and simplified, so as to ensure that they are proportionate and founded on a risk-based approach, whilst ensuring that sailplane operations are carried out safely.
- (3) As regards oversight of persons and organisations, the requirements laid down in Article 3 of Regulation (EU) No 965/2012 and Annex II to that Regulation should continue to apply with respect to air operations with sailplanes.
- (4) In the interest of safety and with a view to ensuring compliance with the essential requirements laid down in Annex V to Regulation (EU) 2018/1139, all operators of sailplanes covered by this Regulation, with the exception of design or production organisations performing certain operations, should be subject to a set of basic requirements.
- (5) Taking into account the less complex nature and smaller scale of commercial operations with sailplanes as compared to other forms of commercial aviation and following a risk-based approach, it is appropriate for commercial operations with sailplanes to only require a prior declaration to the competent authority, as set out in point (a) of Article 30(1) of Regulation (EU) 2018/1139. This Regulation lays down the detailed rules for making such declarations.
- (6) Considering the specific nature of certain operations and following a risk-based approach it is appropriate to exempt certain operations with sailplanes from the requirement of a prior declaration.

¹ OJ L 212, 22.8.2018, p. 1.

² Commission Regulation (EU) No 965/2012 of 5 October 2012 laying down technical requirements and administrative procedures related to air operations pursuant to Regulation (EC) No 216/2008 of the European Parliament and of the Council (OJ L 296, 25.10.2012, p. 1).

- (7) In order to ensure a smooth transition and to give all parties concerned sufficient time to prepare for the application of that new regime, this Regulation should only apply six months after entry into force.
- (8) The European Union Aviation Safety Agency prepared draft implementing rules and submitted them as an opinion¹ to the Commission in accordance with points (b) and (c) of Article 75(2) and Article 76(1) of Regulation (EU) 2018/1139.
- (9) The measures provided for in this Regulation are in accordance with the opinion of the Committee established by Article 127 of Regulation (EU) 2018/1139,

HAS ADOPTED THIS REGULATION:

Article 1 - Subject matter and scope

Regulation (EU) 2020/358

1. This Regulation lays down detailed rules for air operations with sailplanes as well as for issuing and maintaining pilot licences and associated ratings, privileges and certificates for sailplanes, where such aircraft meet the conditions laid down in points (b)(i) and (ii) of Article 2(1) of Regulation (EU) 2018/1139.

Article 2 - Definitions

Regulation (EU) 2020/358

For the purposes of this Regulation, the following definitions and, unless terms are defined otherwise in this Article, the definitions of Article 2 of Regulation (EU) No 1178/2011 apply:

- (1) ‘sailplane’ means a heavier-than-air aircraft that is supported in flight by the dynamic reaction of the air against its fixed lifting surfaces, the free flight of which does not depend on an engine;
- (2) ‘engine’ means a device used or intended to be used for powered sailplane propulsion;
- (3) ‘powered sailplane’ means a sailplane equipped with one or more engines having, with engine(s) inoperative, the characteristics of a sailplane;
- (4) ‘commercial operation’ means any operation of a sailplane, in return for remuneration or other valuable consideration, which is available for the public or, when not made available to the public, which is performed under a contract between an operator and a customer, where the latter has no control over the operator;
- (5) ‘competition flight’ means any air operation with a sailplane performed for the purposes of participating in air races or contests, including practising for such operation and flying to and from air races or contests;
- (6) ‘flying display’ means any air operation with a sailplane performed for the purposes of providing an exhibition or entertainment at an advertised event open to the public, including practising for such operation and flying to and from the advertised event;
- (7) ‘introductory flight’ means any air operation with a sailplane against remuneration or other valuable consideration consisting of an air tour of short duration for the purpose of attracting new trainees or new members, performed either by a training organisation referred to in Article

¹ Opinion No 07/2017 of the European Aviation Safety Agency of 23 August 2017 for a draft Commission Regulation on the revision of the operational rules for sailplanes.

- 10a of Commission Regulation (EU) No 1178/2011¹ or by an organisation created with the aim of promoting aerial sport or leisure aviation;
- (8) ‘aerobatic flight’ means an intentional manoeuvre involving an abrupt change in a sailplane’s attitude, an abnormal attitude or abnormal acceleration, not necessary for normal flight or for instruction for licences, certificates or ratings other than the aerobatic rating;
- (9) ‘principal place of business’ means the head office or registered office of an operator of a sailplane within which the principal financial functions and operational control of the activities referred to in this Regulation are exercised;
- (10) “dry lease agreement” means an agreement between undertakings pursuant to which the sailplane is operated under the responsibility of the lessee;
- (11) “national licence” means a pilot licence issued by a Member State in accordance with national legislation before the date of application of Annex III (Part-SFCL) to this Regulation or of Annex I (Part-FCL) to Regulation (EU) No 1178/2011;
- (12) “Part-SFCL licence” means a flight crew licence which complies with the requirements of Annex III (Part- SFCL) to this Regulation;
- (13) “conversion report” means a report on the basis of which a licence may be converted into a Part-SFCL licence.

Article 3 - Air operations

Regulation (EU) 2018/1976

1. Operators of sailplanes shall operate the sailplanes in accordance with the requirements set out in Annex II.

The first subparagraph shall not apply to design or production organisations which comply with Articles 8 and 9, respectively, of Commission Regulation (EU) No 748/2012² and which operate the sailplane, within the scope of their privileges, for the purposes of the introduction or modification of sailplane types.

2. In accordance with point (a) of Article 30(1) of Regulation (EU) 2018/1139 operators of sailplanes shall engage in commercial operations only after having declared to the competent authority their capacity and means to discharge the responsibilities associated with the operation of the sailplane.

The first subparagraph shall not apply to the following operations with sailplanes:

- (a) cost-shared operations, provided that the direct costs of the flight of the sailplane and a proportionate part of the annual costs incurred for the storage, insurance and maintenance of the sailplane are shared by the individuals on board;
- (b) competition flights or flying displays, provided that the remuneration or any other valuable consideration for such flights is limited to the recovery of the direct costs of the flight of the sailplane and a proportionate part of the annual costs incurred for the

¹ Commission Regulation (EU) No 1178/2011 of 3 November 2011 laying down technical requirements and administrative procedures related to civil aviation aircrew pursuant to Regulation (EC) No 216/2008 of the European Parliament and of the Council (OJ L 311, 25.11.2011, p. 1).

² Commission Regulation (EU) No 748/2012 of 3 August 2012 laying down implementing rules for the airworthiness and environmental certification of aircraft and related products, parts and appliances, as well as for the certification of design and production organisations (OJ L 224, 21.8.2012, p. 1).

storage, insurance and maintenance of the sailplane and that any prizes gained do not exceed the value specified by the competent authority;

- (c) introductory flights, flights for the purposes of parachute dropping, sailplane towing or aerobatic flights performed either by a training organisation having its principal place of business in a Member State and referred to in Article 10a of Regulation (EU) No 1178/2011, or by an organisation created for the purposes of promoting aerial sport or leisure aviation, provided that the organisation operates the sailplane on the basis of either ownership or a dry lease agreement, that the flight does not generate profits distributed outside of the organisation and that such flights represent only a marginal activity of the organisation;
- (d) training flights, performed by a training organisation having its principal place of business in a Member State and referred to in Article 10a of Regulation (EU) No 1178/2011.

GM1 to Article 3(2)(a);(b) Air operations

ED Decision 2019/001/R

DIRECT COSTS

‘Direct costs’ refer to the costs directly incurred in relation to a flight, for example, fuel or other energy costs of the powered sailplane and the retrieve vehicle directly incurred in relation to a flight, take-off and landing fees, and rental fee for a sailplane. Direct costs do not include profit or salary of the pilot.

GM2 to Article 3(2)(a);(b) Air operations

ED Decision 2019/001/R

ANNUAL COSTS

‘Annual costs’ refer to the costs of the sailplane over a period of 1 calendar year, excluding any profit or salary of the pilot.

GM1 to Article 3(2)(c) Air operations

ED Decision 2019/001/R

ORGANISATION CREATED FOR THE PURPOSES OF PROMOTING AERIAL SPORT OR LEISURE AVIATION

An ‘organisation created for the purposes of promoting aerial sport or leisure aviation’ refers to any non-profit organisation established under applicable national law for the sole purpose of gathering persons sharing the same interest in general aviation to fly for pleasure or to conduct parachute jumping. Usual practice is that such organisation has sailplanes available.

GM2 to Article 3(2)(c) Air operations

ED Decision 2019/001/R

MARGINAL ACTIVITY

The term ‘marginal activity’ is understood to represent a very minor part of the overall activity of an organisation, mainly for the purpose of promoting itself or attracting new students or members. An organisation intending to offer such flights as regular business activity is not considered to meet the condition of marginal activity. Also, flights organised with the sole intent to generate income for the organisation are not considered to be a marginal activity.

Article 3a - Pilot licences and medical certification

Regulation (EU) 2020/358

1. Without prejudice to Commission Delegated Regulation (EU)¹, pilots of aircraft referred to in Article 1(1) of this Regulation shall comply with the technical requirements and administrative procedures laid down in Annex III (Part-SFCL) to this Regulation and in Annex IV (Part-MED) to Regulation (EU) No 1178/2011.
2. As an exception to the privileges of the holders of licences as defined in Annex III (Part-SFCL) to this Regulation, holders of such licences may carry out flights referred to in points (a) to (d) of Article 3(2) without complying with point SFCL.115(a)(3) of Annex III (Part-SFCL) to this Regulation
3. A Member State may authorise student pilots who follow a sailplane pilot licence ('SPL') training course to exercise limited privileges without supervision before they meet all the requirements that are necessary for the issue of an SPL in accordance with Annex III (Part-SFCL) to this Regulation, subject to all of the following conditions:
 - (a) the scope of the privileges granted shall be based on a safety risk assessment carried out by the Member State, taking into account the extent of training necessary for the intended level of pilot competence to be achieved; (b) the privileges shall be limited to the following:
 - (i) the whole or part of the national territory of the authorising Member State; and
 - (ii) sailplanes that are registered in the authorising Member State;
 - (c) the holder of an authorisation who applies for the issue of an SPL shall receive credits for training conducted on the basis of a recommendation from an approved training organisation ('ATO') or a declared training organisation ('DTO');
 - (d) the Member State shall submit reports and safety risk assessments to the Commission and the European Union Aviation Safety Agency ('EASA') every 3 years;
 - (e) the Member State shall monitor the use of authorisations issued under this paragraph to ensure an acceptable level of aviation safety and take appropriate action in case of identifying an increased safety risk or any safety concerns.

Article 3b - Existing pilot licences and national medical certificates

Regulation (EU) 2020/358

1. Part-FCL licences for sailplanes and associated privileges, ratings and certificates issued by a Member State before the date of application of this Regulation shall be deemed to have been issued in accordance with this Regulation. Member States shall replace those licences with licences that comply with the format laid down in Annex VI (Part-ARA) to Regulation (EU) No 1178/2011 when they reissue licences for administrative reasons or upon a request of licence holders.
2. When a Member State reissues licences and associated privileges, ratings and certificates in accordance with paragraph 1, the Member State shall, as applicable:
 - (a) transfer all privileges endorsed so far in Part-FCL licences to the new licence format;

¹ Commission Delegated Regulation (EU) of 4 March 2020 (not yet published in the Official Journal).

- (b) convert aerobatic ratings issued in accordance with point FCL.800 of Annex I (Part-FCL) to Regulation (EU) No 1178/2011 into advanced aerobatic privileges in accordance with point SFCL.200(c) of Annex III (Part-SFCL) to this Regulation;
 - (c) endorse the expiry date of a flight instructor certificate associated with a Part-FCL licence into the pilot's logbook or issue an equivalent document. After that expiry date, pilots shall exercise instructor privileges only when they comply with point SFCL.360 of Annex III (Part-SFCL) to this Regulation.
3. Holders of national licences for sailplanes issued by a Member State before the date of application of Annex III (Part-SFCL) to this Regulation shall be allowed to continue to exercise the privileges of their licences until 8 April 2021. By that date, Member States shall convert those licences into Part-SFCL licences and associated ratings, privileges and certificates in accordance with the elements laid down in a conversion report that complies with the requirements of Article 4(4) and (5) of Regulation (EU) No 1178/2011.
4. National pilot medical certificates associated with a licence as specified in paragraph 2 of this Article and issued by a Member State before the date of application of Annex III (Part-SFCL) to this Regulation shall remain valid until the date of their next revalidation or until 8 April 2021, whichever is the earliest. The revalidation of such medical certificates shall comply with the requirements of Annex IV (Part-MED) to Regulation (EU) No 1178/2011.

Article 3c - Credit for training that commenced prior to the date of application of this Regulation

Regulation (EU) 2020/358

1. In respect of issuing Part-SFCL licences and associated privileges, ratings or certificates in accordance with Annex III (Part-SFCL) to this Regulation, training that commenced prior to the date of application of this Regulation in accordance with Annex I (Part-FCL) to Regulation (EU) No 1178/2011 shall be deemed to comply with the requirements of this Regulation.
2. Training that commenced prior to the date of application of this Regulation or of Annex I (Part-FCL) to Regulation (EU) No 1178/2011, in accordance with Annex 1 to the Chicago Convention, shall be credited for the purposes of issuing Part-SFCL licences on the basis of a credit report established by the Member State in consultation with the EASA.
3. The credit report referred to in paragraph 2 shall describe the scope of the training, indicate for which requirements of Part-SFCL credit is given and, if applicable, which requirements applicants need to comply with in order to be issued with a Part-SFCL licence. It shall include copies of all the documents necessary to attest the scope of the training, as well as copies of the national regulations and procedures in accordance with which the training was initiated.

Article 3d - Training organisations

Regulation (EU) 2020/358

1. Training organisations for obtaining the pilot licences referred to in Article 1(1) of this Regulation shall comply with the requirements of Article 10a of Regulation (EU) No 1178/2011.
2. Training organisations referred to in paragraph 1 which hold an approval issued in accordance with Annex VII (Part-ORA) to Regulation (EU) No 1178/2011 or have submitted a declaration in accordance with Annex VIII (Part-DTO) to Regulation (EU) No 1178/2011 before the date of application of this Regulation shall adapt their training programmes, where necessary, by 8 April 2021 at the latest.

Article 4 - Entry into force and application

Regulation (EU) 2018/1976

This Regulation shall enter into force on the twentieth day following that of its publication in the *Official Journal of the European Union*.

It shall apply from 9 July 2019.

Regulation (EU) 2018/1976

This Regulation shall be binding in its entirety and directly applicable in all Member States.

Done at Brussels, 14 December 2018.

For the Commission

The President

Jean-Claude JUNCKER

ANNEX I

DEFINITIONS (Part-DEF)

Regulation (EU) 2020/358

For the purpose of this Regulation, the following definitions and, unless terms are defined otherwise in this Annex, the definitions of Article 2 of Commission Regulation (EU) No 1178/2011 as well as of point FCL.010 of Annex I (Part-FCL) to that Regulation, shall apply:

1. 'acceptable means of compliance (AMC)' means non-binding standards adopted by the Agency to illustrate means to establish compliance with Regulation (EU) 2018/1139 and its delegated and implementing acts;
2. 'alternative means of compliance (AltMoC)' means those means that propose an alternative to an existing AMC or those that propose new means to establish compliance with Regulation (EU) 2018/1139 and its delegated and implementing acts for which no associated AMC have been adopted by the Agency;
3. 'pilot-in-command (PIC)' means the pilot designated as being in command and charged with the safe conduct of the flight;
4. 'aircraft flight manual (AFM)' means the document containing the applicable and approved operating limitations and information with respect to the sailplane;
5. 'psychoactive substances' means alcohol, opioids, cannabinoids, sedatives and hypnotics, cocaine, other psychostimulants, hallucinogens, and volatile solvents, with the exception of caffeine and tobacco;
6. 'critical phases of flight' means take-off run, take-off flight path, final approach, missed approach, landing, including landing roll, and any other phases of flight which the pilot-in-command determines as critical for the safe operation of the sailplane;
7. 'operating site' means a site, other than an aerodrome, selected by the pilot-in-command or the operator for landing or take-off;
8. 'crew member' means a person assigned by an operator to perform duties on board the sailplane, when not the pilot-in-command himself or herself, under the authority of the pilot-in-command;
9. 'electronic flight bag (EFB)' means an electronic information system, comprised of equipment and applications for flight crew, which allows for the storing, updating, displaying and processing of EFB functions to support flight operations or duties;
10. 'dangerous goods' means articles or substances which are capable of posing a risk to health, safety, property or the environment and which are shown in the list of dangerous goods in the technical instructions or which are classified according to those instructions;
11. 'technical instructions' means the latest effective edition of the 'Technical instructions for the safe transport of dangerous goods by air', including the supplement and any addenda, published by ICAO in document 9284-AN/905;
12. 'sailplane specialised operation' means any operation, which can be commercial or non-commercial, with a sailplane the main purpose of which is not associated with typical sport and recreational operations, but parachute operations, news media flights, television or movie flights, flying display or similar specialised activities;

-
13. “night” means the period between the end of evening civil twilight and the beginning of morning civil twilight. Civil twilight ends in the evening when the centre of the sun’s disc is six degrees below the horizon and begins in the morning when the centre of the sun’s disc is six degrees below the horizon;
 14. “skill test” means the demonstration of skill for the purpose of issuing a licence or rating, or extension of a privilege, including oral examinations as may be required;
 15. “assessment of competence” means the demonstration of skill, knowledge and attitude for the initial issue, revalidation or renewal of an instructor or examiner certificate;
 16. “flight time” means:
 - (a) for self-launch sailplanes and touring motor gliders, the total time from the moment an aircraft first moves for the purpose of taking off until the moment it finally comes to rest at the end of the flight;
 - (b) for sailplanes, the total time from the moment the sailplane commences the ground run in the process of taking off until the moment the sailplane finally comes to a rest at the end of flight;
 17. “proficiency check” means the demonstration of skill for the purpose of complying with the recency requirements as established in this Regulation, and including oral examinations as may be required;
 18. “solo flight” means a flight during which a student pilot is the sole occupant of an aircraft;
 19. “cross-country flight” means a flight outside the line of sight or distance defined by the competent authority from the field of departure using standard navigation procedures.

FCL.010 Definitions related to Part-SFCL

Regulation (EU) 2020/359

List of definitions from Part-FCL relevant in the content of Part-SFCL:

- "Aircraft" means any machine which can derive support in the atmosphere from the reactions of the air other than the reactions of the air against the earth's surface.
- "Category of aircraft" means a categorisation of aircraft according to specified basic characteristics, for example aeroplane, powered-lift, helicopter, airship, sailplane, free balloon.
- "Competency" means a combination of skills, knowledge and attitude required to perform a task to the prescribed standard.
- "Dual instruction time" means flight time or instrument ground time during which a person is receiving flight instruction from a properly authorised instructor.
- "Error" means an action or inaction taken by the flight crew which leads to deviations from organisational or flight intentions or expectations.
- "Error management" means the process of detecting and responding to errors with countermeasures which reduce or eliminate the consequences of errors, and mitigate the probability of errors or undesired aircraft states.
- "Pilot-in-command" (PIC) means the pilot designated as being in command and charged with the safe conduct of the flight.
- "Renewal" (of, e.g. a rating or certificate) means the administrative action taken after a rating or certificate has lapsed for the purpose of renewing the privileges of the rating or certificate for a further specified period consequent upon the fulfilment of specified requirements.
- "Revalidation" (of, e.g. a rating or certificate) means the administrative action taken within the period of validity of a rating or certificate which allows the holder to continue to exercise the privileges of a rating or certificate for a further specified period consequent upon the fulfilment of specified requirements.
- "Threat" means events or errors which occur beyond the influence of the flight crew, increase operational complexity and which must be managed to maintain the margin of safety.
- "Threat management" means the process of detecting and responding to the threats with countermeasures which reduce or eliminate the consequences of threats, and mitigate the probability of errors or undesired aircraft states.
- "Touring Motor Glider" (TMG) means, unless otherwise specified following the certification process in accordance with Annex I (Part 21) to Regulation (EU) No 748/2012, a specific class of powered sailplanes that has an integrally mounted, non-retractable engine and a non-retractable propeller. It shall be capable of taking off and climbing under its engine power according to its flight manual.

ANNEX II — SAILPLANE AIR OPERATIONS (PART-SAO)

SUBPART GEN – GENERAL REQUIREMENTS

SAO.GEN.100 Scope

Regulation (EU) 2018/1976

In accordance with Article 3, this Subpart establishes the requirements to be met by any operator of sailplanes, other than design or production organisations referred to in the second subparagraph of Article 3(1).

SAO.GEN.105 Competent authority

Regulation (EU) 2018/1976

The competent authority shall be the authority designated by the Member State where the operator has its principal place of business or, where the operator has no principal place of business, the place where the operator is established or resides. That authority shall be subject to the requirements of Article 3 of Regulation (EU) No 965/2012 in accordance with Article 1(7) of that Regulation.

SAO.GEN.110 Demonstration of compliance

Regulation (EU) 2018/1976

- (a) An operator shall, when so requested by the competent authority which is verifying continued compliance by the operator in accordance with point ARO.GEN.300(a)(2) of Annex II to Regulation (EU) No 965/2012, demonstrate compliance with the essential requirements set out in Annex V to Regulation (EU) 2018/1139 and with the requirements of this Regulation.
- (b) In order to demonstrate such compliance, the operator may refer to the following means:
 - (1) acceptable means of compliance (AMC);
 - (2) alternative means of compliance (AltMoC).

AMC1 SAO.GEN.110(a) Demonstration of compliance

ED Decision 2019/001/R

SAILPLANES REGISTERED IN ANOTHER MEMBER STATE

- (a) The operator of a sailplane which is not registered in the Member State, where the sailplane is predominantly based, should notify the competent authority of that Member State prior to the start of operation.
- (b) The notification should include:
 - (1) sailplane type;
 - (2) sailplane registration;
 - (3) main base;
 - (4) expected duration of the operation; and
 - (5) contact details of the operator.

GM1 SAO.GEN.110(b)(2) Demonstration of compliance

ED Decision 2019/001/R

ALTERNATIVE MEANS OF COMPLIANCE

An alternative means of compliance (AltMoC):

- (a) ensures full compliance with the implementing rule;
- (b) does not need to be approved by the competent authority; and
- (c) needs, in accordance with point (c) of point [SAO.DEC.100](#), to be notified to the competent authority, when commercial operations requiring a declaration are conducted.

SAO.GEN.115 Introductory flights

Regulation (EU) 2018/1976

Introductory flights shall be:

- (a) operated under visual flight rules (VFR) by day; and
- (b) overseen as regards their safety by a person who has been nominated by the organisation responsible for the introductory flights.

SAO.GEN.120 Immediate reaction to a safety problem

Regulation (EU) 2018/1976

The operator shall implement:

- (a) safety measures mandated by the competent authority in accordance with point (c) of point ARO.GEN.135 of Annex II to Regulation (EU) No 965/2012; and
- (b) airworthiness directives and other mandatory information issued by the Agency in accordance with point (h) of Article 77(1) of Regulation (EU) 2018/1139.

SAO.GEN.125 Designation of the pilot-in-command

Regulation (EU) 2020/358

The operator shall designate a pilot-in-command who is qualified to act as pilot-in-command in accordance with Annex III to this Regulation.

SAO.GEN.130 Responsibilities of the pilot-in-command

Regulation (EU) 2018/1976

The pilot-in-command shall:

- (a) be responsible for the safety of the sailplane and of any person on board during sailplane operations;
- (b) be responsible for the initiation, continuation or termination of a flight in the interest of safety;
- (c) ensure that all applicable operational procedures and checklists are complied with;
- (d) only commence a flight if he or she is satisfied that all operational requirements are complied with, as follows:
 - (1) the sailplane is airworthy;
 - (2) the sailplane is duly registered;

- (3) instruments and equipment required for the execution of the flight are carried on board the sailplane and are operative;
 - (4) the mass of the sailplane and the centre of gravity location are such that the flight can be conducted within the limits defined by the aircraft flight manual (AFM);
 - (5) all equipment and baggage are properly loaded and secured, and an emergency evacuation remains possible; and
 - (6) the operating limitations of the sailplane, as specified in the AFM, will not be exceeded at any time during the flight;
- (e) ensure that the pre-flight inspection has been carried out as specified in the AFM;
 - (f) not perform duties on a sailplane in one of the following situations:
 - (1) when he or she is incapacitated from performing duties by any cause, including injury, sickness, medication, fatigue or the effects of any psychoactive substance, or feels otherwise unfit;
 - (2) if applicable medical requirements are not fulfilled;
 - (g) refuse carriage of or disembark any person or baggage that may represent a potential hazard to the safety of the sailplane or any person carried therein;
 - (h) not allow a person to be carried in the sailplane who appears to be under the influence of psychoactive substances to the extent that the safety of the sailplane or the persons therein is likely to be endangered;
 - (i) ensure that during critical phases of flight or whenever deemed necessary in the interest of safety, all persons on board are seated and have their safety belt fastened;
 - (j) during flight:
 - (1) keep his or her safety belt fastened; and
 - (2) remain at the control of the sailplane at all times except if another pilot is taking the controls;
 - (k) take any action in an emergency situation that requires immediate decision and action which he or she considers necessary under the circumstances. In such cases, he or she may deviate from rules, operational procedures and methods to the extent necessary in the interest of safety;
 - (l) not continue a flight beyond the nearest weather-permissible aerodrome or operating site, when his or her capacity to perform his or her duties is significantly reduced because of sickness, fatigue or lack of oxygen or any other cause;
 - (m) record utilisation data and all known or suspected defects in the sailplane at the termination of the flight, or series of flights, in the aircraft technical log or journey log;
 - (n) notify the safety investigation authority of the State in the territory of which the occurrence took place and the emergency services of that State without delay by the quickest available means of any accident or serious incident involving the sailplane;
 - (o) submit a report of an act of unlawful interference without delay to the competent authority and inform the local authority designated by the State in the territory of which the unlawful interference took place; and

- (p) report to the appropriate air traffic services (ATS) unit, without delay, any hazardous weather or flight conditions encountered that are likely to affect the safety of other aircraft.

AMC1 SAO.GEN.130(c) Responsibilities of the pilot-in-command

ED Decision 2019/001/R

CHECKLISTS

- (a) The pilot-in-command should use the latest checklists provided by the type certificate holder or the operator.
- (b) If checks conducted before take-off are suspended at any point, the pilot-in-command should restart them from a safe point prior to the interruption.

AMC1 SAO.GEN.130(d)(4) Responsibilities of the pilot-in-command

ED Decision 2019/001/R

USE OF OTHER DOCUMENTS

For those sailplanes, where the current mass and the centre of gravity location are not available in the aircraft flight manual (AFM), other documents, such as the mass and balance report, should be used.

AMC1 SAO.GEN.130(f) Responsibilities of the pilot-in-command

ED Decision 2019/001/R

DIVING AND BLOOD DONATION

Diving and blood donation may be a cause of incapacitation. The pilot-in-command should not perform duties on a sailplane until a reasonable time period has elapsed after deep water diving or following blood donation.

AMC1 SAO.GEN.130(f) & SAO.GEN.135(b) Responsibilities of the pilot-in-command & responsibilities of crew members

ED Decision 2019/001/R

ALCOHOL CONSUMPTION

The pilot-in-command and any other crew member should observe the following restrictions:

- (a) no alcohol should be consumed less than 8 hours prior to a flight;
- (b) the blood alcohol level should not exceed the lower of the national requirements or 0.2 grams of alcohol in 1 litre of blood at the start of a flight; and
- (c) no alcohol should be consumed during the flight.

AMC1 SAO.GEN.130(p) Responsibilities of the pilot-in-command

ED Decision 2019/001/R

REPORTING OF HAZARDOUS FLIGHT CONDITIONS

- (a) These reports should include any detail which may be pertinent to the safety of other aircraft.
- (b) When unexpected meteorological conditions affecting other aircraft are encountered that, in the opinion of the pilot-in-command, may affect the safety or the efficiency of other aircraft

operations, he or she should advise the appropriate air traffic services (ATS) unit as soon as practicable.

GM1 SAO.GEN.130(a);(b) Responsibilities of the pilot-in-command

ED Decision 2019/001/R

GENERAL

In accordance with the essential requirements for air operations, which are laid down in Annex V to Regulation (EU) 2018/1139¹, the pilot-in-command is responsible for the operation and safety of the sailplane and for the safety of the passenger on board. This includes the following:

- (a) the safety of the passenger on board, as soon as he or she arrives on board until he or she leaves the sailplane; and
- (b) the operation and safety of the sailplane from the moment the launch procedure is started until the sailplane comes to rest at the end of the flight.

GM1 SAO.GEN.130(f) Responsibilities of the pilot-in-command

ED Decision 2019/001/R

DIVING AND BLOOD DONATION — ELAPSED TIME BEFORE RETURNING TO FLYING DUTY

24 hours is a suitable minimum length of time to allow after normal recreational (sport) diving or normal blood donation before a flight. This is considered when determining a reasonable time period.

GM1 SAO.GEN.130(f) & SAO.GEN.135(b) Responsibilities of the pilot-in-command & responsibilities of crew members

ED Decision 2019/001/R

PART-MED

Requirements and information on the effects of medication, psychoactive substances and other treatments can be found in Annex IV (Part-MED) to Regulation (EU) No 1178/2011², and its associated acceptable means of compliance and guidance material.

GM1 SAO.GEN.130(m) Responsibilities of the pilot-in-command

ED Decision 2019/001/R

RECORDING UTILISATION DATA

Where a sailplane conducts a series of flights of short duration, the utilisation data for the series of flights may be recorded in the aircraft technical log or journey log as a single entry.

¹ Regulation (EU) 2018/1139 of the European Parliament and of the Council of 4 July 2018 on common rules in the field of civil aviation and establishing a European Union Aviation Safety Agency, and amending Regulations (EC) No 2111/2005, (EC) No 1008/2008, (EU) No 996/2010, (EU) No 376/2014 and Directives 2014/30/EU and 2014/53/EU of the European Parliament and of the Council, and repealing Regulations (EC) No 552/2004 and (EC) No 216/2008 of the European Parliament and of the Council and Council Regulation (EEC) No 3922/91 (OJ L 212, 22.8.2018, p. 1).

² Commission Regulation (EU) No 1178/2011 of 3 November 2011 laying down technical requirements and administrative procedures related to civil aviation aircrew pursuant to Regulation (EC) No 216/2008 of the European Parliament and of the Council (OJ L 311, 25.11.2011, p. 1).

GM2 SAO.GEN.130(m) Responsibilities of the pilot-in-command

ED Decision 2019/001/R

SERIES OF FLIGHTS

- (a) 'Series of flights' refers to consecutive flights, which begin and end:
 - (1) within a 24-hour period; and
 - (2) at the same operating site or remain within a local area.
- (b) The term 'series of flights' is used to facilitate a single set of documentation.

SAO.GEN.135 Responsibilities of crew members

Regulation (EU) 2018/1976

- (a) Any crew member shall be responsible for the proper execution of his or her duties in respect of the operation of the sailplane.
- (b) Any crew member shall not perform duties on a sailplane when incapacitated by any cause, including injury, sickness, medication, fatigue or the effects of any psychoactive substance, or if he or she feels otherwise unfit.
- (c) Any crew member shall report to the pilot-in-command both of the following:
 - (1) any fault, failure, malfunction or defect, which he or she believes may affect the airworthiness or safe operation of the sailplane, including emergency systems;
 - (2) any incident.

GM1 SAO.GEN.135 Responsibilities of crew members

ED Decision 2019/001/R

DESIGNATION OF A PERSON AS A CREW MEMBER

- (a) A crew member may be any person designated by the pilot-in-command or the operator, provided that:
 - (1) the role, according to the reasonable expectation of the pilot-in-command or the operator, will enhance the safety of the flight or achieve an operational objective of the flight;
 - (2) the person, according to the reasonable expectation of the pilot-in-command or of the operator, is capable of fulfilling the role;
 - (3) the person has been briefed on the role as a crew member and informed that he or she is crew, not a passenger; and
 - (4) the person agrees to the role as a crew member.
- (b) A crew member may be required, by specific provisions of this Regulation and other implementing rules, to hold licences, ratings or other personnel certificates to fulfil certain roles such as instructor or examiner in certain circumstances.

SAO.GEN.140 Compliance with laws, regulations and procedures

Regulation (EU) 2018/1976

- (a) The pilot-in-command and any other crew member shall comply with the laws, regulations and procedures of those States where operations are conducted.
- (b) The pilot-in-command shall be familiar with the laws, regulations and procedures, pertinent to the performance of his or her duties, prescribed for the areas to be traversed, the aerodromes or operating sites to be used and the related air navigation facilities.

SAO.GEN.145 Portable electronic devices

Regulation (EU) 2018/1976

The pilot-in-command shall not permit any person to use a portable electronic device (PED) on board a sailplane, including an electronic flight bag (EFB), that adversely affects the performance of the sailplane's systems and equipment or the ability to operate it.

GM1 SAO.GEN.145 Portable electronic devices

ED Decision 2019/001/R

CATEGORIES OF PORTABLE ELECTRONIC DEVICES

Portable electronic devices (PEDs) are any kind of electronic device, typically but not limited to consumer electronics, brought on board the sailplane by any person and that are not included in the approved sailplane configuration. All equipment that is able to consume electrical energy falls under this definition. The electrical energy can be provided from internal sources such as batteries (rechargeable or non-rechargeable) or the devices may also be connected to specific sailplane power sources.

PEDs include the following two categories:

- (a) Non-intentional transmitters can non-intentionally radiate radio frequency (RF) transmissions, sometimes referred to as spurious emissions. This category includes but is not limited to calculators, cameras, radio receivers, audio and video players, electronic games and toys, when these devices are not equipped with a transmitting function.
- (b) Intentional transmitters (T-PEDs) radiate RF transmissions on specific frequencies as part of their intended function. In addition, they may radiate non-intentional transmissions like any PED. T-PEDs are transmitting devices such as RF-based remote control equipment, which may include some toys, two-way radios (sometimes referred to as 'private mobile radios'), mobile phones of any type, satellite phones, computers with mobile phone data connection, wireless local area network (WLAN) or Bluetooth capability. After deactivation of the transmitting capability, e.g. by activating the so-called 'flight mode' or 'flight safety mode', the T-PED remains a PED having non-intentional emissions.

GM2 SAO.GEN.145 Portable electronic devices

ED Decision 2019/001/R

GENERAL

- (a) PEDs can pose a risk of interference with electronically operated sailplane systems. Those systems could range from the electronic engine control, instruments, navigation or communication equipment to any other type of avionic equipment on the sailplane. The interference can result in on-board systems malfunctioning or providing misleading information

and communication disturbance. These can also lead to an increased workload for the flight crew.

- (b) Interference may be caused by transmitters being part of the PED's functionality or by unintentional transmissions from the PED. Due to the likely proximity of the PED to any electronically operated sailplane system and the generally limited shielding found in sailplanes, the risk of interference is to be considered higher than that for larger aircraft with metal airframes.
- (c) During certification of the sailplane, when qualifying the sailplane functions, consideration may only have been made of short-term exposure to a high-radiating field, with an acceptable mitigating measure being a return to normal function after removal of the threat. This certification assumption may not be true when operating the transmitting PED on board the sailplane.
- (d) It has been found that compliance with electromagnetic compatibility provisions and related European standards, as indicated by the CE marking, is not sufficient to exclude the existence of interference. A well-known interference is the demodulation of the transmitted signal from GSM (global system for mobile communications) mobile phones leading to audio disturbances in other systems. Similar interferences are difficult to predict during the PED design, and protecting the sailplane's electronic systems against the full range of potential interferences is practically impossible. Therefore, not operating PEDs on board the sailplane is the safest option, especially as effects may not be identified immediately but under the most inconvenient circumstances.
- (e) Guidance to follow in case of fire caused by PEDs is provided by the latest effective edition of the International Civil Aviation Organization, 'Emergency response guidance for aircraft incidents involving dangerous goods', ICAO Doc 9481-AN/928.

SAO.GEN.150 Dangerous goods

Regulation (EU) 2018/1976

- (a) The pilot-in-command shall not permit any person to carry dangerous goods on board.
- (b) Reasonable quantities of articles and substances that would otherwise be classified as dangerous goods and that are used to facilitate flight safety, where carriage on board the sailplane is advisable to ensure their timely availability for operational purposes, shall be considered authorised.

AMC1 SAO.GEN.150(b) Dangerous goods

ED Decision 2019/001/R

REASONABLE QUANTITIES

The carriage of reasonable quantities of articles and substances should be permitted regardless of whether or not such articles and substances are required to be carried or intended to be used in connection with a particular flight. The packing and loading on board should be performed, under the responsibility of the pilot-in-command, in such a way as to minimise the risks posed to crew members, passengers or the sailplane during operation.

GM1 SAO.GEN.150 Dangerous goods

ED Decision 2019/001/R

EXAMPLES

Dangerous goods include the following:

- (a) explosives (fireworks, flares, detonators, fuses, dynamite, ammunition and materials for fireworks in general);
- (b) compressed, liquefied or dissolved gases (aerosols, self-defence sprays, camping gas, extinguishers, cryogenic liquids, bottles with cooling gases and compressed gas cylinders in general);
- (c) flammable liquids and solids (fuel, equipment containing fuel, oil, adhesives, solvents, paint, petrol, varnish, torches, cigarette lighters and lighter refills);
- (d) substances that emit flammable gases in contact with water;
- (e) oxidisers and organic peroxides (oxygen generators and bleaching powder); and
- (f) substances liable to spontaneous combustion (strike-anywhere matches and phosphorous).

SAO.GEN.155 Documents, manuals and information to be carried

Regulation (EU) 2018/1976

- (a) All of the following documents, manuals and information shall be carried on each flight as originals or copies:
 - (1) the AFM, or equivalent document(s);
 - (2) details of the filed ATS flight plan, when required in accordance with Section 4 of the Annex to Commission Implementing Regulation (EU) No 923/2012¹;
 - (3) current and suitable aeronautical charts for the area of the intended flight;
 - (4) any other documentation that may be pertinent to the flight or is required by the States concerned with the flight;
 - (5) procedures and visual signals information for use by intercepting and intercepted aircraft.
- (b) In addition, when a declaration is required in accordance with point [SAO.DEC.100](#), a copy of the declaration shall be carried on each flight.
- (c) When not carried on board, all of the following documents, manuals and information shall remain available at the aerodrome or operating site as originals or copies:
 - (1) the certificate of registration;
 - (2) the certificate of airworthiness, including the annexes;
 - (3) the airworthiness review certificate;
 - (4) the noise certificate, if a noise certificate has been issued for a powered sailplane;

¹ Commission Implementing Regulation (EU) No 923/2012 of 26 September 2012 laying down the common rules of the air and operational provisions regarding services and procedures in air navigation and amending Implementing Regulation (EU) No 1035/2011 and Regulations (EC) No 1265/2007, (EC) No 1794/2006, (EC) No 730/2006, (EC) No 1033/2006 and (EU) No 255/2010 (OJ L 281, 13.10.2012, p. 1).

- (5) the aircraft radio licence, where the sailplane is equipped with radio communication equipment in accordance with point [SAO.IDE.130](#);
 - (6) the third-party liability insurance certificate(s);
 - (7) the journey log or equivalent.
- (d) By derogation from points (a) and (b), the documents, manuals and information specified therein may be retained at the aerodrome or operating site for flights:
- (1) intending to remain within the sight of the aerodrome or operating site; or
 - (2) remaining within a distance or area determined by the competent authority.
- (e) When requested by the competent authority, the pilot-in-command or the operator shall make available to that authority the original documentation in the time period specified by the authority which shall not be less than 24 hours.

AMC1 SAO.GEN.155 Documents, manuals and information to be carried

ED Decision 2019/001/R

GENERAL

- (a) In case of loss or theft of documents, manuals and information to be carried, the operation may continue until the flight reaches the base or a place where a replacement document can be provided.
- (b) The documents, manuals and information may be available in a form other than on printed paper. An electronic storage medium should be acceptable if accessibility, usability and reliability can be assured.

AMC1 SAO.GEN.155(a)(3) Documents, manuals and information to be carried

ED Decision 2019/001/R

CURRENT AND SUITABLE AERONAUTICAL CHARTS

- (a) The aeronautical charts carried should contain data appropriate to the applicable air traffic regulations, rules of the air, flight altitudes, area, route, and nature of the operation. Due consideration should be given to the carriage of textual and graphic representations of:
 - (1) aeronautical data, including, as appropriate for the nature of the operation:
 - (i) airspace structure;
 - (ii) communication frequencies;
 - (iii) prohibited, restricted and danger areas; and
 - (iv) sites of other relevant activities that may hazard the flight; and
 - (2) topographical data, including terrain and obstacle data.
- (b) A combination of different charts and textual data may be used to provide adequate and current data.
- (c) The aeronautical data should be appropriate for the current aeronautical information regulation and control (AIRAC) cycle.

- (d) The topographical data should be reasonably recent, having regard to the nature of the planned operation.

AMC1 SAO.GEN.155(c)(2) Documents, manuals and information to be carried

ED Decision 2019/001/R

CERTIFICATE OF AIRWORTHINESS

The certificate of airworthiness should be a standard certificate of airworthiness, a restricted certificate of airworthiness or a permit to fly issued in accordance with Regulation (EU) No 748/2012¹.

GM1 SAO.GEN.155(a)(1) Documents, manuals and information to be carried

ED Decision 2019/001/R

AFM OR EQUIVALENT DOCUMENT(S)

- (a) 'AFM or equivalent document(s)' refers to the flight manual for the sailplane or other documents containing information required for the operation of the sailplane within the terms of its certificate of airworthiness.
- (b) At least the operating limitations, normal and emergency procedures are available to the pilot during operation by providing the specific sections of the AFM or by other means (e.g. placards, quick reference cards) that effectively accomplish the purpose.

GM1 SAO.GEN.155(a)(4) Documents, manuals and information to be carried

ED Decision 2019/001/R

DOCUMENTS THAT MAY BE PERTINENT TO THE FLIGHT OR REQUIRED BY THE STATES CONCERNED WITH THE FLIGHT

- (a) Any other documents that may be pertinent to the flight or are required by the States concerned with the flight may include, for example, forms to comply with reporting requirements.
- (b) The States concerned are those of origin, overflight and destination of the flight.

GM1 SAO.GEN.155(a)(5) Documents, manuals and information to be carried

ED Decision 2019/001/R

PROCEDURES AND VISUAL SIGNALS FOR USE BY INTERCEPTING AND INTERCEPTED AIRCRAFT

¹ Commission Regulation (EU) No 748/2012 of 3 August 2012 laying down implementing rules for the airworthiness and environmental certification of aircraft and related products, parts and appliances, as well as for the certification of design and production organisations (OJ L 224, 21.8.2012, p.1).

The procedures and the visual signals information used in the airspace of EU Member States by intercepting and intercepted aircraft are those contained in Regulation (EU) No 923/2012¹ (the standardised European rules of the air (SERA)).

GM1 SAO.GEN.155(c)(7) Documents, manuals and information to be carried

ED Decision 2019/001/R

JOURNEY LOG OR EQUIVALENT

'Journey log or equivalent' refers to the possibility of having the required information recorded in documentation other than a logbook, such as the operational flight plan or the sailplane technical log.

SAO.GEN.160 Journey log

Regulation (EU) 2018/1976

For each flight, or series of flights, particulars of the sailplane, its crew and each journey shall be retained in the form of a journey log or an equivalent document.

AMC1 SAO.GEN.160 Journey log

ED Decision 2019/001/R

GENERAL

- (a) The journey log, or equivalent, should include the following items, where applicable:
- (1) sailplane nationality and registration;
 - (2) date;
 - (3) name of flight crew member(s);
 - (4) duty assignments of crew member(s), if applicable;
 - (5) place of departure;
 - (6) place of arrival;
 - (7) time of departure;
 - (8) time of arrival;
 - (9) hours of flight;
 - (10) nature of flight;
 - (11) incidents and observations, if any; and
 - (12) signature of the pilot-in-command.
- (b) The information or parts thereof may be recorded in a form other than on printed paper. Accessibility, usability and reliability should be assured.

¹ Commission Implementing Regulation (EU) No 923/2012 of 26 September 2012 laying down the common rules of the air and operational provisions regarding services and procedures in air navigation and amending Implementing Regulation (EU) No 1035/2011 and Regulations (EC) No 1265/2007, (EC) No 1794/2006, (EC) No 730/2006, (EC) No 1033/2006 and (EU) No 255/2010 (OJ L 281, 13.12.2012, p. 1).

SUBPART OP – OPERATING PROCEDURES

SAO.OP.100 Use of aerodromes and operating sites

Regulation (EU) 2018/1976

The pilot-in-command shall only use aerodromes and operating sites that are adequate for the type of sailplane and operation concerned.

GM1 SAO.OP.100 Use of aerodromes and operating sites

ED Decision 2019/001/R

GENERAL

If the pilot-in-command cannot fly safely to an aerodrome or operating site, he or she may decide to conduct an outlanding, i.e. a landing at an unprepared site.

SAO.OP.105 Noise abatement procedures – powered sailplanes

Regulation (EU) 2018/1976

The pilot-in-command shall take into account operating procedures to minimise the effect of powered sailplane noise, while ensuring that safety has priority over noise abatement.

SAO.OP.110 Passenger briefing

Regulation (EU) 2018/1976

The pilot-in-command shall ensure that before and, when appropriate, during the flight, the passenger is given a briefing on normal, abnormal and emergency procedures.

AMC1 SAO.OP.110 Passenger briefing

ED Decision 2019/001/R

GENERAL

The passenger briefing should include the locations and use of safety belts and, if applicable:

- (a) emergency canopy opening;
- (b) parachute;
- (c) oxygen dispensing equipment; and
- (d) other emergency equipment provided for individual passenger use.

GM1 SAO.OP.110 Passenger briefing

ED Decision 2019/001/R

GENERAL

Either the pilot-in-command or a person designated by the operator is carrying out the passenger briefing.

SAO.OP.115 Carriage of special categories of passengers

Regulation (EU) 2018/1976

The pilot-in-command shall ensure that persons requiring special conditions, assistance or devices when carried on board a sailplane are carried under conditions that ensure the safety of the sailplane and of any person or property carried therein.

SAO.OP.120 Flight preparation

Regulation (EU) 2018/1976

Before commencing a flight, the pilot-in-command shall ensure all of the following:

- (a) the facilities required for the safe operation of the sailplane are adequate for the type of operation under which the flight is to be conducted;
- (b) that the meteorological conditions will allow the flight to be completed safely;
- (c) in the case of a powered sailplane and when the engine is intended to be used, the quantity of fuel or other energy is sufficient to allow the flight to be completed safely.

GM1 SAO.OP.120(a) Flight preparation

ED Decision 2019/001/R

FACILITIES REQUIRED

Facilities include:

- (a) required communication facilities and navigation aids;
- (b) global navigation satellite system (GNSS), if applicable; and
- (c) access to airspace required for the flight.

SAO.OP.125 Refuelling and recharging or replacing of batteries with persons on board – powered sailplanes

Regulation (EU) 2018/1976

When a passenger is on board a powered sailplane:

- (a) the sailplane shall not be refuelled; and
- (b) the batteries used for propulsion shall not be recharged or replaced.

SAO.OP.130 Smoking on board

Regulation (EU) 2018/1976

No person shall smoke on board a sailplane during any phase of flight.

SAO.OP.135 Meteorological conditions

Regulation (EU) 2018/1976

The pilot-in-command shall only commence or continue a flight if the latest available meteorological information indicates that a safe landing option remains available.

GM1 SAO.OP.135 Meteorological conditions

ED Decision 2019/001/R

SAFE LANDING OPTION

- (a) 'Safe landing option' refers to an aerodrome, operating site or outlanding site that can be reached and used safely in accordance with normal operating procedures and the applicable rules of the air. The safe landing option may be the point of departure.
- (b) In order to focus on a safe landing option, the pilot-in-command considers, among other things:
 - (1) the suitability and operating requirements of the chosen landing site;
 - (2) the technical suitability of the sailplane; and
 - (3) his or her experience, including outlanding training, when applicable.

SAO.OP.140 Ice and other contaminants – ground procedures

Regulation (EU) 2018/1976

The pilot-in-command shall only commence take-off if the sailplane is clear of any deposit that might adversely affect the performance or controllability of the sailplane, except when permitted in the AFM.

SAO.OP.145 In-flight fuel or other energy management – powered sailplanes

Regulation (EU) 2018/1976

For powered sailplanes, the pilot-in-command shall check at regular intervals during the flight that the amount of usable fuel or other energy available is not less than that needed to ensure a safe landing.

GM1 SAO.OP.145 In-flight fuel or other energy management – powered sailplanes

ED Decision 2019/001/R

GENERAL

'Fuel or other energy management' refers to the pilot-in-command being aware of the fuel or other energy-used-for-propulsion state of the powered sailplane. If the pilot-in-command intends continuation of the flight in pure gliding, this includes awareness of actual range with or without expected thermals or other sources of updraft.

SAO.OP.150 Use of supplemental oxygen

Regulation (EU) 2018/1976

The pilot-in-command shall ensure that all persons on board use supplemental oxygen whenever he or she determines that, at the altitude of the intended flight, lack of oxygen might result in impairment of their faculties or harmfully affect them.

AMC1 SAO.OP.150 Use of supplemental oxygen

ED Decision 2019/001/R

GENERAL

When the pilot-in-command cannot determine how the lack of oxygen might affect the persons on board, he or she should ensure that all occupants use supplemental oxygen for any period when the pressure altitude is above 10 000 ft.

SAO.OP.155 Sailplane specialised operations

Regulation (EU) 2018/1976

- (a) Before commencing a sailplane specialised operation or a series thereof, the pilot-in-command shall conduct a risk assessment, assessing the complexity of the activity in order to determine the hazards and associated risks of the intended operation and establish mitigating measures where necessary.
- (b) A sailplane specialised operation shall be performed in accordance with a checklist. The pilot-in-command shall establish that checklist and ensure that it is appropriate to the specialised activity and sailplane used, based on the risk assessment and taking account of all requirements set out in this Annex. The checklist shall be readily accessible on each flight to the pilot-in-command and any other crew member, where it is relevant for the performance of their duties.
- (c) The pilot-in-command shall regularly review and update the checklist where necessary in order to adequately take account of the risk assessment.

AMC1 SAO.OP.155 Sailplane specialised operations

ED Decision 2019/001/R

CRITERIA FOR SAILPLANE SPECIALISED OPERATIONS

The pilot-in-command or the operator should consider the following criteria to determine whether an activity falls within the scope of sailplane specialised operations:

- (a) special equipment affecting the behaviour of the sailplane in flight is necessary to fulfil the task;
or
- (b) persons leave the sailplane during flight.

AMC1 SAO.OP.155(b) Sailplane specialised operations

ED Decision 2019/001/R

CHECKLIST – GENERAL

- (a) The checklist should take into consideration the latest technical publications and recommendations from the:
 - (1) type certification holder;
 - (2) Agency; and
 - (3) competent authority.
- (b) The use of a generic checklist, for example one developed by an association, should be acceptable, provided the pilot-in-command adapts it, if required, to address specific or local risks.

AMC2 SAO.OP.155(b) Sailplane specialised operations

ED Decision 2019/001/R

CHECKLIST FOR PARACHUTE OPERATIONS

The checklist for parachute operations should contain:

- (a) normal, abnormal and emergency procedures;
- (b) relevant performance data;
- (c) required equipment;
- (d) any limitations such as maximum take-off mass and minimum landing mass;
- (e) any possible shift of the centre of gravity; and
- (f) responsibilities and duties of the pilot-in-command and, if applicable, of any other crew member.

GM1 SAO.OP.155 Sailplane specialised operations

ED Decision 2019/001/R

LIST OF OPERATIONS

- (a) Sailplane specialised operations include the following activities:
 - (1) parachute operations;
 - (2) aerial advertising flights, i.e. banner towing with powered sailplanes;
 - (3) news media flights, television and movie flights; and
 - (4) flying display.
- (b) The following operations are not considered sailplane specialised operations, but normal operations:
 - (1) sailplane towing;
 - (2) competition flights; and
 - (3) aerobatic flights.

GM2 SAO.OP.155 Sailplane specialised operations

ED Decision 2019/001/R

CATEGORISATION OF OPERATIONS

The pilot-in-command or the operator determines whether the activity falls within the scope of a sailplane specialised operation. For this determination, the pilot-in-command or the operator considers the criteria in point [AMC1 SAO.OP.155](#) and the activities listed in point (a) of point [GM1 SAO.OP.155](#).

GM1 SAO.OP.155(b) Sailplane specialised operations

ED Decision 2019/001/R

DEVELOPMENT OF CHECKLIST

In order to develop a checklist, the pilot-in-command or the operator takes into account at least the following items:

- (a) nature and complexity of the activity:
 - (1) the nature of the flight and risk exposure;
 - (2) the complexity of the activity taking into account the necessary pilot skills and level of experience, ground support, safety, and individual protective equipment;
 - (3) the operational environment and geographical area; and
 - (4) the result of the risk assessment and evaluation;
- (b) sailplane and equipment:

All equipment required for the activity should be listed;
- (c) crew member(s):
 - (1) crew composition;
 - (2) duties of the crew member(s);
 - (3) minimum crew experience and training provisions; and
 - (4) recency provisions;
- (d) normal, abnormal and emergency procedures:
 - (1) operating procedures for the flight crew; and
 - (2) ground procedures for the crew member(s); and
- (e) records:

It should be determined which records specific to the flight(s) are to be kept, such as task details, sailplane registration, pilot-in-command, flight times, weather and any remarks, including a record of occurrences affecting flight safety or the safety of persons or property on the ground.

SUBPART POL – PERFORMANCE AND OPERATING LIMITATIONS

SAO.POL.100 Weighing

Regulation (EU) 2018/1976

- (a) The weighing of the sailplane shall be accomplished by the manufacturer of the sailplane or in accordance with Annex I to Commission Regulation (EU) No 1321/2014¹.
- (b) The operator shall ensure that the mass of the sailplane has been established by actual weighing prior to its initial entry into service. The accumulated effects of modifications and repairs on the mass shall be accounted for and properly documented. Such information shall be made available to the pilot-in-command. The sailplane shall be reweighed if the effects of modifications or repairs on the mass are not known.

GM1 POL.100 Weighing

ED Decision 2019/001/R

INSTRUCTIONS FOR CONTINUING AIRWORTHINESS AND PERSONNEL REQUIRED

- (a) The weighing is conducted in accordance with the applicable instructions for continuing airworthiness (maintenance manual), as laid down in point (b)(3) of point M.A.401 of Annex I to Regulation (EU) No 1321/2014².
- (b) The weighing is a maintenance action, which requires a release to service by personnel specified in point (b) of point M.A.801 of Annex I to Regulation (EU) No 1321/2014.

SAO.POL.105 Performance – general

Regulation (EU) 2018/1976

The pilot-in-command shall only operate the sailplane if the performance of the sailplane is adequate to comply with the requirements set out in the Annex to Implementing Regulation (EU) No 923/2012 and any other restrictions applicable to the flight, the airspace, aerodromes or operating sites used, ensuring that any charts or maps used are the latest available edition.

¹ Commission Regulation (EU) No 1321/2014 of 26 November 2014 on the continuing airworthiness of aircraft and aeronautical products, parts and appliances, and on the approval of organisations and personnel involved in these tasks (OJ L 362, 17.12.2014, p. 1).

² Commission Regulation (EU) No 1321/2014 of 26 November 2014 on the continuing airworthiness of aircraft and aeronautical products, parts and appliances, and on the approval of organisations and personnel involved in these tasks (OJ L 362, 17.12.2014, p. 1).

SUBPART IDE – INSTRUMENTS, DATA AND EQUIPMENT

SAO.IDE.100 Instruments and equipment – general

Regulation (EU) 2018/1976

- (a) Instruments and equipment required by this Subpart shall be approved in accordance with Annex I to Regulation (EU) No 748/2012 or, when registered in a third country, with the airworthiness requirements of the state of registry, if one of the following conditions is fulfilled:
- (1) they are used by the flight crew to control the flight path;
 - (2) they are used to comply with points [SAO.IDE.130](#) or [SAO.IDE.135](#);
 - (3) they are permanently installed in the sailplane.
- (b) By way of derogation from point (a), all of the following instruments or equipment, when required by this Subpart, shall not need an approval:
- (1) independent portable lights;
 - (2) an accurate timepiece;
 - (3) survival and signalling equipment.
- (c) Instruments and equipment shall be readily operable or accessible from the station where either the pilot-in-command or any other crew member, who needs to use them, is seated.

GM1 SAO.IDE.100 Instruments and equipment – general

ED Decision 2019/001/R

INSTRUMENTS AND EQUIPMENT NOT REQUIRED

- (a) Non-required instruments and equipment do not need to be approved in accordance with airworthiness requirements. However, their installation needs to be approved in accordance with these requirements, as part of which the instrument or equipment is accepted for installation on a non-hazard basis.
- (b) The failure of additional, non-installed instruments or equipment not required by this Annex or by the applicable airworthiness requirements or any applicable airspace requirements should not adversely affect the airworthiness or the safe operation of the sailplane. Examples may be PEDs carried by a crew member or a passenger.

GM1 SAO.IDE.100(a)(3) Instruments and equipment – general

ED Decision 2019/001/R

PERMANENTLY INSTALLED

‘Permanently installed’ refers to an installation that requires a release to service in accordance with point M.A.801 of Annex I to Regulation (EU) No 1321/2014.

SAO.IDE.105 Flight and navigational instruments

Regulation (EU) 2018/1976

- (a) Sailplanes shall be equipped with a means of measuring and displaying all of the following:
- (1) time in hours and minutes;

- (2) pressure altitude;
 - (3) indicated airspeed;
 - (4) in the case of powered sailplanes, magnetic heading.
- (b) In addition to (a), when operating in conditions where the sailplane cannot be maintained on a desired flight path without reference to one or more additional instruments, when conducting cloud flying or when operating at night, sailplanes shall be equipped with means of measuring and displaying all of the following:
- (1) vertical speed;
 - (2) attitude or turn and slip;
 - (3) magnetic heading.

AMC1 SAO.IDE.105 Flight and navigational instruments

ED Decision 2019/001/R

INTEGRATED INSTRUMENTS

Individual equipment requirements may be met by combinations of instruments or by integrated flight systems or by a combination of parameters on electronic displays. The information so available to each required pilot should not be less than that required in the applicable operational requirements, and the equivalent safety of the installation should be approved during type certification of the sailplane for the intended type of operation.

AMC1 SAO.IDE.105(a)(1) Flight and navigational instruments

ED Decision 2019/001/R

MEANS OF MEASURING AND DISPLAYING THE TIME

A means of measuring and displaying the time in hours and minutes may be a wristwatch capable of the same functions.

AMC1 SAO.IDE.105(a)(2) Flight and navigational instruments

ED Decision 2019/001/R

SCALING OF THE MEANS FOR MEASURING AND DISPLAYING PRESSURE ALTITUDE

- (a) The instrument measuring and displaying pressure altitude should be of a sensitive type, scaled in metres (m), with a sub-scale setting, scaled in hectopascals/millibars, adjustable for any barometric pressure likely to be set during flight.
- (b) Scaling in feet (ft) is also acceptable.

AMC1 SAO.IDE.105(a)(3) Flight and navigational instruments

ED Decision 2019/001/R

SCALING OF THE INSTRUMENT INDICATING AIRSPEED

- (a) The instrument indicating airspeed should be scaled in kilometres per hour (kph).
- (b) Scaling in knots (kt) or in miles per hour (mph) is also acceptable.

AMC1 SAO.IDE.105(a)(4);(b)(3) Flight and navigational instruments

ED Decision 2019/001/R

MEANS OF MEASURING AND DISPLAYING MAGNETIC HEADING

The means of measuring and displaying magnetic direction should be a magnetic compass or equivalent.

GM1 SAO.IDE.105(b) Flight and navigational instruments

ED Decision 2019/001/R

CONDITIONS WHERE THE SAILPLANE CANNOT BE MAINTAINED IN A DESIRED ATTITUDE WITHOUT REFERENCE TO ONE OR MORE ADDITIONAL INSTRUMENTS

Sailplanes operating in conditions where the sailplane cannot be maintained in a desired attitude without reference to one or more additional instruments refers to a condition where the sailplane is still operating under visual flight rules (VFR), under visual meteorological conditions (VMC), although there is no external reference such as the natural horizon or a coastline, that would allow the attitude to be maintained. Such conditions may occur over water, in a desert or in snow-covered areas where the colour of the surface cannot be distinguished from the colour of the sky and therefore no external reference is available. Cloud flying is not considered to be one of these conditions.

SAO.IDE.110 Operating lights

Regulation (EU) 2018/1976

Sailplanes operated at night shall be equipped with all of the following:

- (a) an anti-collision light system;
- (b) navigation/position lights;
- (c) a landing light;
- (d) lighting supplied from the sailplane's electrical system to provide adequate illumination for all instruments and equipment essential to the safe operation of the sailplane;
- (e) an independent portable light for the pilot-in-command and any other crew member station.

SAO.IDE.115 Supplemental oxygen

Regulation (EU) 2018/1976

Sailplanes operated, when an oxygen supply is required in accordance with point [SAO.OP.150](#), shall be equipped with oxygen storage and dispensing apparatus capable of storing and dispensing the required oxygen supplies.

SAO.IDE.120 Life-saving and signalling equipment – flights over water

Regulation (EU) 2018/1976

The pilot-in-command of a sailplane operated over water shall determine, before commencing the flight, the risks to survival of any person carried in the sailplane in the event of ditching. In light of those risks, he or she shall determine whether there is a need to carry life-saving and signalling equipment.

AMC1 SAO.IDE.120 Life-saving and signalling equipment – flights over water

ED Decision 2019/001/R

RISK ASSESSMENT

In order to determine the risk, the pilot-in-command should take the following operating environment and conditions into account:

- (a) water state;
- (b) water and air temperatures;
- (c) the distance from land suitable for making an emergency landing; and
- (d) the availability of search and rescue facilities.

AMC2 SAO.IDE.120 Life-saving and signalling equipment – flights over water

ED Decision 2019/001/R

SIGNALLING AND LIFE-SAVING EQUIPMENT

Based on the risk assessment, the pilot-in-command should determine the carriage of:

- (a) a life jacket or equivalent individual flotation device for each person on board that should:
 - (1) be worn or stowed in a position that is readily accessible from the seat of the person for whose use it is provided; and
 - (2) be equipped with a means of electric illumination for the purpose of facilitating the location of persons;
- (b) an emergency locator transmitter (ELT) or a personal locator beacon (PLB), capable of transmitting simultaneously at 121.5 and 406 MHz, or an equivalent registered emergency locator, carried by the pilot-in-command, any other crew member or a passenger; and
- (c) signalling equipment for making distress signals.

AMC3 SAO.IDE.120 Life-saving and signalling equipment – flights over water

ED Decision 2019/001/R

BRIEFING ON PLB USE

When a passenger carries a PLB, he or she should be briefed on its characteristics and use by the pilot-in-command or a person designated by the operator before the flight.

GM1 SAO.IDE.120 Life-saving and signalling equipment – flights over water

ED Decision 2019/001/R

TERMINOLOGY

- (a) An ELT is a generic term describing equipment that broadcasts distinctive signals on designated frequencies and, depending on application, may be activated by impact or may be manually activated.
- (b) A PLB is an emergency beacon, other than an ELT, that broadcasts distinctive signals at designated frequencies, is stand-alone, portable, and is manually activated by the survivors.

AMC4 SAO.IDE.120 Life-saving and signalling equipment – flights over water

ED Decision 2019/001/R

ELT AND PLB REGISTRATION AND OPERATION PROVISIONS

- (a) Any ELT and PLB carried should be registered with the national agency responsible for initiating search and rescue, or another nominated agency.
- (b) Any ELT carried should operate in accordance with the relevant provisions of Volume III of ICAO Annex 10 to the Chicago Convention, 'Aeronautical telecommunications'.

SAO.IDE.125 Life-saving and signalling equipment – search and rescue difficulties

Regulation (EU) 2018/1976

Sailplanes operated over areas in which search and rescue (SAR) would be especially difficult shall be equipped with such life-saving and signalling equipment as appropriate to the area overflown.

AMC1 SAO.IDE.125 Life-saving and signalling equipment – search and rescue difficulties

ED Decision 2019/001/R

GENERAL

Sailplanes operated across land areas in which search and rescue would be especially difficult should be equipped with the following:

- (a) at least one ELT, one PLB or one equivalent registered emergency locator;
- (b) signalling equipment for making distress signals; and
- (c) additional survival equipment for the route to be flown taking account of the number of persons on board.

GM1 SAO.IDE.125 Life-saving and signalling equipment – search and rescue difficulties

ED Decision 2019/001/R

AREAS IN WHICH SEARCH AND RESCUE WOULD BE ESPECIALLY DIFFICULT

The phrase ‘areas in which search and rescue would be especially difficult’ refers to:

- (a) areas so designated by the authority responsible for managing search and rescue; or
- (b) areas that are largely uninhabited and where the authority referred to in (a):
 - (1) has not published any information to confirm whether search and rescue would be or would not be especially difficult; and
 - (2) does not, as a matter of policy, designate areas as being especially difficult for search and rescue.

GM2 SAO.IDE.125 Life-saving and signalling equipment – search and rescue difficulties

ED Decision 2019/001/R

SIGNALS

The signals for making distress signals are described in Regulation (EU) No 923/2012.

SAO.IDE.130 Radio communication equipment

Regulation (EU) 2018/1976

Sailplanes shall have radio communication equipment to allow for the communication required in accordance with Appendix 4 to the Annex to Implementing Regulation (EU) No 923/2012, and, if the flight takes place in the airspace of a third country, the law of that third country.

AMC1 SAO.IDE.130 Radio communication equipment

ED Decision 2019/001/R

GENERAL

When radio communication equipment is required, it should:

- (a) be capable of conducting two-way communication with those aeronautical stations and on those frequencies prescribed for the respective airspace; and
- (b) provide for communication on the aeronautical emergency frequency 121.5 MHz.

SAO.IDE.135 Transponder

Regulation (EU) 2018/1976

Sailplanes shall have a secondary surveillance radar (SSR) transponder with all the capabilities required in accordance with point (b) of point SERA.6005 of the Annex to Implementing Regulation (EU) No 923/2012, and, if the flight takes places in airspace of a third country, the law of that third country.

GM1 SAO.IDE.135 Transponder

ED Decision 2019/001/R

GENERAL

Under point [SAO.IDE.135](#), the carriage of a secondary surveillance radar (SSR) transponder is only required, when operating in a portion of airspace designated by the competent authority as a transponder mandatory zone in accordance with point (b) of point SERA.6005 of the Annex to Regulation (EU) No 923/2012.

SUBPART DEC – DECLARATION

SAO.DEC.100 Declaration

Regulation (EU) 2018/1976

- (a) In the declaration referred to in Article 3(2), the operator shall confirm that it complies and will continue to comply with the essential requirements set out in Annex V to Regulation (EU) 2018/1139 and with the requirements of this Regulation.
- (b) The operator shall include in the declaration all of the following information:
 - (1) the name of the operator;
 - (2) the place where the operator has its principal place of business;
 - (3) the contact details of the operator;
 - (4) the starting date of the operation and, where relevant, the date at which the change to an existing declaration takes effect;
 - (5) in respect of all sailplanes used for the commercial operation, the sailplane type, registration, main base, type of operation and continuing airworthiness management organisation.
- (c) The operator shall, when making the declaration, notify to the competent authority the list of AltMoC to demonstrate compliance when so requested in accordance with point [SAO.GEN.110](#). That list shall contain references to the associated AMC.
- (d) When making the declaration, the operator shall use the form contained in the [Appendix](#) to this Annex.

GM1 SAO.DEC.100 Declaration

ED Decision 2019/001/R

GENERAL

The declaration's purposes are to:

- (a) have the operator acknowledge its responsibilities under the applicable safety regulations and that it holds all necessary approvals;
- (b) inform the competent authority of the existence of an operator; and
- (c) enable the competent authority to fulfil its oversight responsibilities.

SAO.DEC.105 Changes to the declaration and cessation of commercial operations

Regulation (EU) 2018/1976

- (a) Without delay the operator shall notify to the competent authority any changes in circumstances affecting its compliance with the essential requirements set out in Annex V to Regulation (EU) 2018/1139 and with the requirements of this Regulation, as declared to the competent authority, and of any changes in respect of the information referred to in point [SAO.DEC.100\(b\)](#) and the list of AltMoC referred to in point [SAO.DEC.100\(c\)](#), as included in or annexed to the declaration.

- (b) Without delay the operator shall notify the competent authority that it is no longer engaged in commercial operations with sailplanes.

AMC1 SAO.DEC.105(a) Changes to the declaration and cessation of commercial operations

ED Decision 2019/001/R

CHANGES

The new declaration should be submitted before the change becomes effective, indicating the date as of which the change would apply.

Appendix

Regulation (EU) 2018/1976

DECLARATION				
in accordance with Commission Implementing Regulation (EU) 2018/1976				
Operator				
Name:				
Place where the operator has its principal place of business:				
Contact details:				
Sailplane operation				
Starting date of commercial operation and, where relevant, date of change to existing commercial operation:				
Information on sailplane(s) used, commercial operation(s) and continuing airworthiness management ⁽¹⁾ :				
Sailplane type	Sailplane registration	Main base	Type(s) of operation ⁽²⁾	Continuing airworthiness management organisation ⁽³⁾
Where applicable, list of AltMoC with references to the associated AMC (annex to the declaration):				
Statements				
<input type="checkbox"/> The operator complies, and will continue to comply, with the essential requirements set out in Annex V to Regulation (EU) 2018/1139 and with the requirements of Implementing Regulation (EU) 2018/1976 In particular, the operator conducts its commercial operations in accordance with the following requirements of Annex II to Implementing Regulation (EU) 2018/1976:				
<input type="checkbox"/> All sailplanes operated have a certificate of airworthiness ⁽⁴⁾ issued in accordance with Regulation (EU) No 748/2012.				
<input type="checkbox"/> Any pilot holds a license and ratings issued or accepted in accordance with Annex I to Regulation (EU) No 1178/2011, as required by point SAO.GEN.125 of Annex II.				
<input type="checkbox"/> The operator will notify to the competent authority any changes in circumstances affecting its compliance with the essential requirements set out in Annex V to Regulation (EU) 2018/1139 and with the requirements of Implementing Regulation (EU) 2018/1976 as declared to the competent authority through this declaration and any changes to the information and lists of AltMoC included in and annexed to this declaration, as required by point SAO.DEC.100(c) of Annex II.				
<input type="checkbox"/> The operator confirms that all information included in this declaration, including its annexes, is complete and correct.				
Date, name and signature				

⁽¹⁾ Complete the table. If there is not enough space to list the information, it shall be listed in a separate annex. The annex shall be dated and signed.

⁽²⁾ 'Type(s) of operation' refers to the type of commercial operation conducted with the sailplane.

⁽³⁾ Information about the organisation responsible for the continuing airworthiness management shall include the name of the organisation, the address and the approval reference.

⁽⁴⁾ The certificate of airworthiness is a normal certificate of airworthiness, a restricted certificate of airworthiness or a permit to fly issued in accordance with the requirements of Annex I to Regulation (EU) No 748/2012.

ANNEX III — REQUIREMENTS FOR SAILPLANE FLIGHT CREW LICENSING (PART-SFCL)

SUBPART GEN – GENERAL REQUIREMENTS

SFCL.001 Scope

Regulation (EU) 2020/358

This Annex establishes the requirements for the issue of a sailplane pilot licence ('SPL') and associated privileges, ratings and certificates, and the conditions for their validity and use.

GM1 SFCL.001 Scope

ED Decision 2020/004/R

TERMINOLOGY USED REGARDING SAILPLANES, POWERED SAILPLANES AND TMGs

- (a) When requirements of Part-SFCL refer to 'sailplanes', this includes powered sailplanes as well as touring motor gliders (TMGs), unless otherwise specified.
- (b) In the context of sailplanes excluding TMGs, the term 'launch' is used, while in the context of TMGs, the term 'take-off' is used.

SFCL.005 Competent authority

Regulation (EU) 2020/358

For the purpose of this Annex, the competent authority shall be an authority designated by the Member State to which a person applies for the issue of an SPL or associated privileges, ratings or certificates.

SFCL.015 Application for and issue, revalidation and renewal of an SPL as well as associated privileges, ratings and certificates

Regulation (EU) 2020/358

- (a) The following shall be submitted to the competent authority in a form and manner established by that competent authority:
 - (1) an application for:
 - (i) the issue of an SPL and associated ratings;
 - (ii) the extension of the privileges of an SPL, except for the privileges specified in points SFCL.115(a)(2) and (a)(3), SFCL.155, SFCL.200 and SFCL.215;
 - (iii) the issue of a sailplane flight instructor ('FI(S)') certificate;
 - (iv) the issue, revalidation and renewal of a sailplane flight examiner ('FE(S)') certificate;
 - (v) any amendments to the SPL and associated privileges, ratings and certificates, except for the privileges referred to in point (ii); and

- (2) if mandated by the competent authority, a copy of the relevant logbook entries as specified in points SFCL.115(d), SFCL.155(b), SFCL.200(f) and SFCL.215(d).
- (b) An application as specified in paragraph (a) shall be accompanied by evidence that the applicant complies with the relevant requirements established in this Annex and in Annex IV (Part-MED) to Regulation (EU) No 1178/2011.
- (c) Any limitation or extension of the privileges granted by a licence, rating or certificate shall be endorsed on the licence or certificate by the competent authority, except for obtaining the privileges as specified in paragraph (a)(1)(ii).
- (d) A person shall not hold at any time more than one SPL issued in accordance with this Annex.
- (e) A licence holder shall submit applications as specified in paragraph (a) to the competent authority designated by the Member State in which any of his or her licences was issued in accordance with this Annex (Part-SFCL), or Annex I (Part-FCL) to Regulation (EU) No 1178/2011 or Annex III (Part-BFCL) to Regulation (EU) 2018/395, as applicable.
- (f) An SPL holder may apply for a change of competent authority to the competent authority designated by another Member State but in such case the new competent authority shall be the same for all the licences held.
- (g) Applicants shall apply for the issue of an SPL and associated ratings, privileges or certificates not later than six months after having successfully completed the skill test or assessment of competence.

AMC1 SFCL.015 Application for and issue, revalidation and renewal of an SPL as well as associated privileges, ratings and certificates

ED Decision 2020/004/R

APPLICATION AND REPORT FORMS

Application and report forms can be found as follows:

- (a) for skill tests and proficiency checks for the sailplane pilot licence (SPL), in AMC1 SFCL.410(b)(3); and
- (b) for the assessment of competence for the flight instructor (sailplane) FI(S), in AMC3 SFCL.345.

SFCL.030 Practical skill test

Regulation (EU) 2020/358

Applicants for a skill test shall be recommended for the skill test by the ATO or the DTO that is responsible for the training undertaken by the applicants, once the training is completed. The training records shall be made available to the examiner by the ATO or DTO.

SFCL.035 Crediting of flight time

Regulation (EU) 2020/358

Applicants for an SPL or an associated privilege, rating or certificate shall be fully credited with all solo, dual instruction or PIC flight time on sailplanes towards the requirement of a total flight time for the licence, privilege, rating or certificate.

SFCL.045 Obligation to carry and present documents

Regulation (EU) 2020/358

- (a) When exercising the privileges of SPL licence, SPL holders shall carry all of the following:
 - (1) a valid SPL;
 - (2) a valid medical certificate;
 - (3) a personal identification document containing his or her photo;
 - (4) sufficient logbook data to demonstrate compliance with the requirements of this Annex.
- (b) Student pilots shall carry on all solo cross-country flights:
 - (1) the documents as specified in paragraphs (a)(2) and (a)(3);
 - (2) evidence of the authorisation required by point SFCL.125(a).
- (c) SPL holders or student pilots shall without undue delay present the documents as specified in paragraph (a) for inspection upon request by an authorised representative of the competent authority.
- (d) By way of derogation from paragraphs (a) and (b), the documents specified therein may be retained at the aerodrome or operating site for flights that remain:
 - (1) within the sight of the aerodrome or operating site; or
 - (2) within a distance from the aerodrome or operating site determined by the competent authority.

AMC1 SFCL.045(a)(4) Obligation to carry and present documents

ED Decision 2020/004/R

SUFFICIENT LOGBOOK DATA

In order to be able to demonstrate compliance with the requirements of Part-SFCL, an SPL holder should carry either the full logbook or at least excerpts or copies (in paper or electronic format) of those parts of the logbook in which compliance with the requirements that are related to the exercised privileges is documented.

SFCL.050 Recording of flight time

Regulation (EU) 2020/358

SPL holders and student pilots shall keep a reliable record of the details of all flights flown in a form and manner established by the competent authority.

AMC1 SFCL.050 Recording of flight time

ED Decision 2020/004/R

GENERAL

- (a) The record of the flights flown should contain at least the following information:
 - (1) personal details: name(s) and address of the pilot; and
 - (2) for each flight:
 - (i) name(s) of pilot-in-command (PIC);

- (ii) date of flight;
 - (iii) place and time of departure and arrival;
 - (iv) type/model and registration of the sailplane;
 - (v) total time of flight;
 - (vi) launching method
 - (vii) accumulated total time of flight;
 - (viii) details on pilot function, namely PIC, including solo, dual, FI(S) or flight examiner (sailplane) FE(S); and
 - (ix) operational conditions (e.g. night, aerobatic, cloud flying).
- (b) Logging of time
- (1) PIC flight time
 - (i) Holders of a licence may log as PIC time all of the flight time during which they are the PIC.
 - (ii) Applicants for or holders of an SPL may log as PIC time all supervised solo flight time as well as flight time of successfully completed skill tests and proficiency checks, provided that, in the case of supervised solo flight time, the logbook entry is signed by the supervising instructor.
 - (iii) Holders of an FI(S) certificate may log as PIC all flight time during which they act as an instructor in a sailplane.
 - (iv) Holders of an FE(S) certificate may log as PIC all flight time during which they act as an examiner in a sailplane.
 - (v) If the holder of an SPL carries out a number of flights upon the same day returning on each occasion to the same place of departure, such series of flights may be recorded as a single entry.
 - (2) Instruction time

A summary of all time logged by an applicant for a licence or rating as flight instruction may be logged if certified by the appropriately rated or authorised instructor from whom it was received.
- (c) Format of the record
- A suitable format should be used that contains the relevant items mentioned in (a) and additional information specific to the type of operation.

SFCL.065 Curtailment of privileges of SPL holders aged 70 years or older in commercial passenger sailplane operations

Regulation (EU) 2020/358

SPL holders who have attained the age of 70 years shall not act as pilots of sailplanes engaged in commercial passenger sailplane operations.

SFCL.070 Limitation, suspension and revocation of licences, privileges, ratings and certificates

Regulation (EU) 2020/358

- (a) An SPL as well as associated privileges, ratings and certificates issued in accordance with this Annex may be limited, suspended or revoked by the competent authority in accordance with the conditions and procedures laid down in Annex VI (Part-ARA) to Regulation (EU) No 1178/2011 if an SPL holder does not comply with the essential requirements set out in Annex IV to Regulation (EU) 2018/1139 or with the requirements of this Annex as well as of Annex II (Part-SAO) to this Regulation or with Annex IV (Part-MED) to Regulation (EU) No 1178/2011.
- (b) SPL holders shall immediately return the licence or certificate to the competent authority if their licence, privilege, rating or certificate has been limited, suspended or revoked.

SUBPART SPL – SAILPLANE PILOT LICENCE ('SPL')

SFCL.115 SPL – Privileges and conditions

Regulation (EU) 2020/358

- (a) Subject to compliance with point SFCL.150, the privileges of SPL holders are to act as PIC in sailplanes:
- (1) without remuneration in non-commercial operations;
 - (2) including the carriage of passengers only if they:
 - (i) comply with point SFCL.160(e); and
 - (ii) either:
 - (A) have completed, after the issue of the SPL, at least 10 hours of flight time or 30 launches or take-offs and landings as PIC on sailplanes and, additionally, one training flight during which holders shall demonstrate to an FI(S) the competence required for the carriage of passengers; or
 - (B) hold an FI(S) certificate in accordance with Subpart FI;
 - (3) in operations other than those specified in paragraph (1), only if they have:
 - (i) attained the age of 18 years;
 - (ii) completed, after the issue of the licence, 75 hours of flight time or 200 launches or take-offs and landings as PIC on sailplanes.
- (b) By way of derogation from paragraph (a), SPL holders who have instructor or examiner privileges may receive remuneration for:
- (1) the provision of flight instruction for the SPL;
 - (2) the conduct of skill tests and proficiency checks for the SPL;
 - (3) the training, testing and checking for the privileges, ratings and certificates attached to an SPL.
- (c) SPL holders shall exercise SPL privileges only if they comply with the applicable recency requirements and only if their medical certificate, appropriate to the privileges exercised, is valid.
- (d) The completion of the training flight as specified in paragraph (a)(2)(ii)(A) shall be entered in the logbook of the pilot and signed by the instructor who is responsible for the training flight.

AMC1 SFCL.115(a)(2)(ii)(A) SPL – Privileges and conditions

ED Decision 2020/004/R

EXPERIENCE AFTER THE ISSUE OF THE SPL NECESSARY FOR THE CARRIAGE OF PASSENGERS

In cases where an SPL has been issued on the basis of a conversion report as per Article 3b(3) of Regulation (EU) 2018/1976, the date of the issue of the originally national sailplane pilot licence or equivalent document should be deemed as the date of the issue of the SPL.

SFCL.120 SPL – Minimum age

Regulation (EU) 2020/358

Applicants for an SPL shall be at least 16 years old.

SFCL.125 SPL – Student pilot

Regulation (EU) 2020/358

- (a) Student pilots shall not fly solo unless authorised to do so and supervised by an FI(S).
- (b) Student pilot shall be at least 14 years of age to be allowed on solo flights.

SFCL.130 SPL – Training course and experience requirements

Regulation (EU) 2020/358

- (a) Applicants for an SPL shall complete a training course at an ATO or a DTO. The course shall be tailored to the privileges sought and shall include:
 - (1) theoretical knowledge as specified in point SFCL.135;
 - (2) at least 15 hours of flight instruction in sailplanes, including at least:
 - (i) 10 hours of dual flight instruction which shall include the dual flight instruction as specified in paragraphs (iv) (A) or (v)(A), as applicable;
 - (ii) two hours of supervised solo flight time;
 - (iii) 45 launches or take-offs and landings;
 - (iv) if privileges for sailplanes, excluding TMGs, are sought, at least seven hours of flight instruction in sailplanes, excluding TMGs, and including at least:
 - (A) three hours of dual flight instruction;
 - (B) either:
 - (a) one solo cross-country flight of at least 50 km (27 NM); or
 - (b) one dual cross-country flight of at least 100 km (55 NM) which, by way of derogation from paragraph (2)(iv), may be completed in a TMG;
 - (v) if privileges for TMGs are sought, at least six hours of flight instruction in TMGs, including at least:
 - (A) four hours of dual flight instruction;
 - (B) one solo cross-country flight of at least 150 km (80 NM) in a TMG, during which one full-stop landing at an aerodrome different from the aerodrome of departure shall be performed.
- (b) Applicants who hold a pilot licence for another category of aircraft, with the exception of balloons licence, shall be credited with 10 % of total flight time as PIC on such aircraft and up to a maximum of seven hours. The amount of credit given shall in any case:
 - (1) not include the requirements of paragraphs (a)(2)(ii), (a)(2)(iv)(B) and (a)(2)(v)(B); and
 - (2) with regard to paragraph (a)(2)(iii), not exceed 10 launches or take-offs and landings.

AMC1 SFCL.130 SPL – Training course and experience requirements

ED Decision 2020/004/R

THEORETICAL KNOWLEDGE INSTRUCTION FOR THE SPL

(a) General

The training should cover aspects related to non-technical skills in an integrated manner, taking into account the particular risks associated with the licence and the activity. The theoretical knowledge instruction provided by the declared training organisation (DTO) or approved training organisation (ATO) should include a certain element of formal classroom work but may also include other methods of delivery — for example, interactive video, slide or tape presentation, computer-based training and other media distance-learning courses. The training organisation responsible for the training has to check whether all the appropriate elements of the training course of theoretical knowledge instruction have been completed to a satisfactory standard before recommending the applicant for the examination.

(b) Syllabus

The following table contains the syllabus for theoretical knowledge instruction for the SPL:

1.	AIR LAW AND ATC PROCEDURES
1.1.	International law: conventions, agreements and organisations
1.2.	Airworthiness of aircraft
1.3.	Aircraft nationality and registration marks
1.4.	Personnel licensing
1.5.	Rules of the air
1.6.	Procedures for air navigation: aircraft operations
1.7.	Air traffic regulations: airspace structure
1.8.	Air traffic service (ATS) and air traffic management (ATM)
1.9.	Aeronautical information services (AIS)
1.10.	Aerodromes, external take-off sites
1.11.	Search and rescue
1.12.	Security
1.13.	Accident reporting
1.14.	National law
2.	HUMAN PERFORMANCE
2.1.	Human factors: basic concepts
2.2.	Basic aviation physiology and health maintenance
2.3.	Basic aviation psychology
2.4.	Use of oxygen
3.	METEOROLOGY
3.1.	The atmosphere
3.2.	Wind
3.3.	Thermodynamics
3.4.	Clouds and fog
3.5.	Precipitation
3.6.	Air masses and fronts
3.7.	Pressure systems
3.8.	Climatology

3.9.	Flight hazards
3.10.	Meteorological information
4.	COMMUNICATIONS
4.1.	Definitions
4.2.	VFR communications
4.2.1.	VFR communication at uncontrolled airfields
4.2.2.	VFR communication at controlled airfields
4.2.3.	VFR communication with ATC (en-route)
4.3.	General operating procedures
4.4.	Relevant weather information terms (VFR)
4.5.	Action required to be taken in case of communication failure
4.6.	Distress and urgency procedures
4.7.	General principles of VHF propagation and allocation of frequencies
5.	PRINCIPLES OF FLIGHT
5.1.	Aerodynamics (airflow)
5.2.	Flight mechanics
5.3.	Stability
5.4.	Control
5.5.	Limitations (load factor and manoeuvres)
5.6.	Stalling and spinning
5.7.	Spiral dive
6.	OPERATIONAL PROCEDURES
6.1.	General requirements
6.2.	Launch methods
6.3.	Soaring techniques
6.4.	Circuits and landing
6.5.	Outlanding
6.6.	Special operational procedures and hazards
6.7.	Emergency procedures
6.8.	Emergency parachute operation and landing
7.	FLIGHT PERFORMANCE AND PLANNING
7.1.	Mass and balance
7.2.	Speed polar of sailplanes or cruising speed
7.3.	Flight planning and task setting
7.4.	ICAO flight plan (ATS flight plan)
7.5.	Flight monitoring and in-flight re-planning
8.	AIRCRAFT GENERAL KNOWLEDGE, AIRFRAME AND SYSTEMS AND EMERGENCY EQUIPMENT
8.1.	Airframe
8.2.	System design, loads and stresses
8.3.	Landing gear, wheels, tyres and brakes
8.4.	Mass and balance
8.5.	Flight controls
8.6.	Instruments
8.7.	Rigging of aircraft, connection of control surfaces
8.8.	Manuals and documents

8.9.	Airworthiness and maintenance
8.10.	Airframe, engines and propellers
8.11	Water ballast systems
8.12	Batteries (performance and operational limitations)
8.13	Emergency parachutes
8.14	Emergency bail-out aid
9.	NAVIGATION
9.1.	Basics of navigation
9.2.	Magnetism and compasses
9.3.	Charts
9.4.	Dead reckoning navigation
9.5.	In-flight navigation
9.6.	Use of GNSS
9.7.	Use of ATS

AMC2 SFCL.130 SPL – Training course and experience requirements

ED Decision 2020/004/R

FLIGHT INSTRUCTION FOR THE SPL

(a) Entry to training

Before being accepted for training, an applicant should be informed that the appropriate medical certificate must be obtained before solo flying is permitted.

(b) Flight instruction — general

- (1) The SPL flight instruction syllabus should take into account the principles of threat and error management (TEM) and also cover:
 - (i) pre-flight operations, including verifying mass and balance, aircraft inspection and servicing, airspace and weather briefing;
 - (ii) rigging of sailplanes, including control surface connections;
 - (iii) aerodrome and traffic pattern operations, collision avoidance precautions and procedures;
 - (iv) control of the aircraft by external visual reference;
 - (v) flight at high angle of attack (critically low air speeds), recognition of, and recovery from, incipient and full stalls and spins;
 - (vi) flight at critically high air speeds, recognition of, and recovery from spiral dive;
 - (vii) normal and crosswind take-offs in respect of the different launch methods;
 - (viii) normal and crosswind landings;
 - (ix) short field landings and outlandings: field selection, circuit and landing hazards and precautions;
 - (x) cross-country flying using visual reference, dead reckoning and available navigation aids;

- (xi) soaring techniques as appropriate to site conditions;
 - (xii) emergency actions;
 - (xiii) considerations for soaring at high altitudes; and
 - (xiv) compliance with air traffic services procedures and communication procedures.
- (2) Before allowing applicants to undertake their first solo flight, the FI should ensure that they can operate the required systems and equipment.
- (c) Syllabus of flight instruction
- (1) The numbering of exercises should be used primarily as an exercise reference list and as a broad instructional sequencing guide; therefore, the demonstrations and practices need not necessarily be given in the order listed. The actual order and content will depend upon the following interrelated factors:
- (i) the applicant's progress and ability;
 - (ii) the weather conditions affecting the flight;
 - (iii) the flight time available;
 - (iv) the instructional technique considerations;
 - (v) the local operating environment; and
 - (vi) the applicability of the exercises to the sailplane type.
- (2) At the discretion of the instructors, some of the exercises may be combined and some other exercises may be done in several flights.
- (3) At least, Exercises 1 to 12 have to be completed before the first solo flight.
- (4) Each of the exercises requires the applicant to be aware of the need for as well as the principles of good airmanship and look-out, which should be emphasised at all times.
- (5) List of exercises
- Exercise 1: Familiarisation with the sailplane**
- (i) characteristics of the sailplane;
 - (ii) cockpit layout: instruments and equipment;
 - (iii) flight controls: stick, pedals, airbrakes, flaps (if available) and trim;
 - (iv) cable release and undercarriage; and
 - (v) checklists, drills and controls.
- Exercise 2: Emergency procedures**
- (i) use of safety equipment (parachute);
 - (ii) reaction to system failures and errors;
 - (iii) bail-out procedure drills; and
 - (iv) parachute landing fall drills.

Exercise 3: Preparation for flight

- (i) pre-flight briefings;
- (ii) required documents on board;
- (iii) equipment required for the intended flight;
- (iv) ground handling, rigging including connection of control surfaces, movements, tow out, parking and security;
- (v) pre-flight external and internal checks;
- (vi) verifying in-limits mass and balance;
- (vii) harness, seat or rudder pedal adjustments; and
- (viii) pre-launch checks.

Exercise 4: Initial air experience

- (i) area familiarisation; and
- (ii) look-out procedures.

Exercise 5: Effects of controls

- (i) look-out procedures;
- (ii) use of visual references;
- (iii) primary effects when laterally level and when banked;
- (iv) reference attitude and effect of elevator;
- (v) relationship between attitude and speed; and
- (vi) effects of:
 - (A) flaps (if available);
 - (B) airbrakes or spoilers (as applicable); and
 - (C) undercarriage (if available).

Exercise 6: Coordinated rolling to and from moderate angles of bank

- (i) look-out procedures;
- (ii) further effects of aileron (adverse yaw) and rudder (roll);
- (iii) coordination; and
- (iv) rolling to and from moderate angles of bank and return to straight flight.

Exercise 7: Straight flying

- (i) look-out procedures;
- (ii) maintaining straight flight;
- (iii) flight at critically high air speeds;
- (iv) demonstration of inherent longitudinal stability;

- (v) control of pitch, including use of trim;
- (vi) lateral level, direction and balance and trim; and
- (vii) air speed: monitoring and control.

Exercise 8: Turning

- (i) look-out procedures;
- (ii) demonstration and correction of adverse yaw;
- (iii) entry to turn (medium turns);
- (iv) stabilised turns;
- (v) exiting turns;
- (vi) faults in the turn (slipping, skidding and speed control);
- (vii) maintaining appropriate look-out procedures;
- (viii) turns on to selected headings and use of compass; and
- (ix) use of instruments (ball indicator or slip string) for precision.

Exercise 9a: Slow flight

Note: The objective is to improve the student's ability to recognise inadvertent flight at critically low speeds (high angle of attack) and to provide practice in maintaining the sailplane in a normal attitude at low speed.

- (i) safety checks;
- (ii) introduction to characteristics of slow flight; and
- (iii) controlled flight down to critically high angle of attack (slow air speed).

Exercise 9b: Stalling

- (i) safety checks;
- (ii) pre-stall symptoms, recognition and recovery;
- (iii) stall symptoms, recognition and recovery in straight flight and in turn;
- (iv) recovery when a wing drops;
- (v) approach to stall in the approach and in the landing configurations; and
- (vi) recognition and recovery from accelerated stalls.

Exercise 10: Recognition and avoidance of spins and spiral dives

- (i) safety checks;
- (ii) stalling and recovery at the incipient spin stage (stall with un-commanded roll/wing drop to about 45 ° and associated yaw);
- (iii) recognition of entry into fully developed spins;
- (iv) recognition of full spins;

- (v) standard spin recovery;
- (vi) instructor induced distractions during the spin entry;
- (vii) recognition of spiral dives;
- (viii) spiral dive recovery; and
- (ix) differentiation between spins and spiral dives.

Note: Consideration of manoeuvre limitations and the need to refer to the sailplane manual and mass and balance calculations.

Note (Exercises 11a to 11e): At least one launch method must be taught containing all the subjects below. A briefing that follows TEM principles should be conducted before every launch.

Exercise 11a: Winch launch

- (i) signals or communication before and during launch;
- (ii) use of the launching equipment;
- (iii) pre-take-off checks;
- (iv) into wind take-off;
- (v) crosswind take-off;
- (vi) safe and adequate profile of winch launch and limitations;
- (vii) release procedures; and
- (viii) launch failure procedures, simulated during the winch launch.

Exercise 11b: Aero tow

- (i) signals or communication before and during launch;
- (ii) use of the launch equipment;
- (iii) pre-take-off checks;
- (iv) into wind take-off;
- (v) crosswind take-off;
- (vi) on tow: straight flight, turning and slip stream;
- (vii) out of position in tow and recovery;
- (viii) descending on tow (towing aircraft and sailplane);
- (ix) release procedures; and
- (x) launch failure and abandonment, simulated by releasing the cable at a suitable height, with and without response to a signal from the tow plane.

Exercise 11c: Self-launch

- (i) review of the flight manual for the sailplane used;

- (ii) engine extending and retraction procedures;
- (iii) engine starting and safety precautions;
- (iv) pre-take-off checks;
- (v) in-flight engine start checks;
- (vi) noise abatement procedures;
- (vii) checks during and after take-off;
- (viii) into wind take-off;
- (ix) crosswind take-off;
- (x) power failures and procedures;
- (xi) abandoned take-off;
- (xii) maximum performance (short field and obstacle clearance) take-off;
- (xiii) short field take-off, soft field procedure or techniques and performance calculations;
- (xiv) in-flight retraction of engine and engine cooling;
- (xv) propeller drag;
- (xvi) effects of reduction and increase of power;
- (xvii) pitch nose-up tendency in case of engine shutdown (in case of over-wing propeller installation);
- (xviii) approach with extended retractable engine inoperative (may be simulated by extended airbrakes);
- (xix) decision process and reasons to terminate the soaring flight and to switch to powered flight; and
- (xx) decision process and reasons for not starting the engine and to end the flight as a non-powered sailplane.

Exercise 11d: Car launch

- (i) signals before and during launch;
- (ii) use of the launch equipment;
- (iii) pre-take-off checks;
- (iv) into wind take-off;
- (v) crosswind take-off;
- (vi) safe and adequate launch profile and limitations;
- (vii) release procedures; and
- (viii) launch failure procedures.

Exercise 11e: Bungee launch

- (i) signals before and during launch;
- (ii) use of the launch equipment;
- (iii) pre-take-off checks; and
- (iv) into wind take-off.

Exercise 12: Circuit, approach and landing

- (i) procedures for rejoining the circuit;
- (ii) collision avoidance, look-out techniques and procedures;
- (iii) pre-landing checks: circuit procedures, downwind and base leg;
- (iv) effect of wind and wind shear on approach and touchdown speeds;
- (v) use of flaps (if applicable);
- (vi) visualisation of an aiming point;
- (vii) approach control and use of airbrakes;
- (viii) normal and crosswind approach and landing; and
- (ix) short landing procedures or techniques.

Exercise 13: First solo flight

- (i) instructor's briefing including limitations;
- (ii) awareness of local area and restrictions;
- (iii) use of required equipment;
- (iv) effects of the centre of gravity (CG) on controllability of sailplane; and
- (v) observation of flight and debriefing by instructor.

Exercise 14: Advanced turning

- (i) steep turns (45 ° or more);
- (ii) stalling and spin avoidance in the turn and recovery; and
- (iii) recoveries from unusual attitudes, including spiral dives.

Note (exercises 15a to 15c): At least one of the three soaring techniques must be taught containing all subjects below.

Exercise 15a: Thermalling

- (i) look-out procedures;
- (ii) detection and recognition of thermals;
- (iii) use of audio soaring instruments;

- (iv) joining a thermal and giving way;
- (v) flying in close proximity to other sailplanes;
- (vi) centring in thermals;
- (vii) leaving thermals; and
- (viii) considerations for use of oxygen.

Exercise 15b: Ridge flying

- (i) look-out procedures;
- (ii) practical application of ridge flying rules;
- (iii) optimisation of flight path;
- (iv) speed control;
- (v) wind shear; and
- (vi) considerations for change of turning radius at same indicated airspeed at different altitudes.

Exercise 15c: Wave flying

- (i) look-out procedures;
- (ii) considerations and techniques for wave access and exit;
- (iii) speed limitations with increasing height; and
- (iv) considerations for use of oxygen.

Exercise 16: Out-landings

- (i) gliding range;
- (ii) restart procedures (only for self-launching and self-sustaining sailplanes);
- (iii) decision process to not start the engine and to outland;
- (iv) selection of landing area;
- (v) circuit judgement and key positions;
- (vi) circuit and approach procedures;
- (vii) actions after landing;
- (viii) determination of wind direction;
- (ix) selection of landing direction; and
- (x) considerations for landing at high slope landing sites.

Note (exercises 17a to 17c): If the required cross-country flight will be conducted as a solo cross-country flight, all the subjects below must be taught before.

Exercise 17a: Flight planning

- (i) weather forecast and actuals;
- (ii) notices to airmen (NOTAMs) and airspace considerations;
- (iii) map selection and preparation;
- (iv) route planning;
- (v) radio frequencies (if applicable);
- (vi) pre-flight administrative procedure, including preparation of additional required equipment, as applicable (e.g. life vest, personal locator beacon);
- (vii) ICAO flight plan where required;
- (viii) mass and performance;
- (ix) mass and balance;
- (x) alternate aerodromes and landing areas; and
- (xi) safety altitudes.

Exercise 17b: In-flight navigation

- (i) maintaining track and re-routing considerations;
- (ii) use of radio and phraseology (if applicable);
- (iii) in-flight planning;
- (iv) procedures for transiting regulated airspace or ATC liaison where required;
- (v) uncertainty of position procedure;
- (vi) lost procedure;
- (vii) use of additional equipment where required; and
- (viii) joining, arrival and circuit procedures at remote aerodrome.

Exercise 17c: Cross-country techniques

- (i) look-out procedures;
- (ii) maximising potential cross-country performance; and
- (iii) risk reduction and threat reaction.

AMC3 SFCL.130 SPL – Training course and experience requirements*ED Decision 2020/004/R***TRAINING ELEMENTS FOR THE INITIAL ISSUE OF AN SPL WITH TMG PRIVILEGES**

For initial SPL training that includes training for TMG privileges, the theoretical knowledge instruction and flight instruction should include the elements specified in points (b) and (c) of AMC1 SFCL.150(b).

GM1 SFCL.130(a)(2)(iv) SPL – Training course and experience requirements

ED Decision 2020/004/R

USE OF TMGs DURING TRAINING FOR THE INITIAL ISSUE OF AN SPL WITHOUT TMG PRIVILEGES

For initial SPL training that does not include training for TMG privileges, TMGs can be used for a maximum of 8 hours (point [SFCL.130\(a\)\(2\)\(iv\)](#)). It follows from the objective of such a training course that all training exercises completed on a TMG must consist of pure gliding manoeuvres, without any TMG-specific manoeuvres. Such pure gliding training in a TMG can be provided by FI(S) certificate holders who do not hold the TMG instructional privileges as specified in point [SFCL.315\(a\)\(4\)](#), provided that the instructor occupies the pilot seat from which all PIC functions can be executed.

SFCL.135 SPL – Theoretical knowledge examination

Regulation (EU) 2020/358

(a) Theoretical knowledge

Applicants for an SPL shall demonstrate a level of theoretical knowledge that is appropriate to the privileges sought through examinations on the following:

- (1) common subjects:
 - (i) air law;
 - (ii) human performance;
 - (iii) meteorology;
 - (iv) communications;
- (2) specific subjects concerning sailplanes:
 - (i) principles of flight;
 - (ii) operational procedures;
 - (iii) flight performance and planning;
 - (iv) aircraft general knowledge related to sailplanes;
 - (v) navigation.

(b) Responsibilities of the applicant

- (1) The applicant shall take the entire set of theoretical knowledge examinations for the SPL under the responsibility of the same Member State's competent authority.
- (2) The applicant shall take the theoretical knowledge examination only if recommended by the ATO or the DTO that is responsible for his or her training and once he or she has completed the appropriate elements of the training course of theoretical knowledge instruction to a satisfactory standard.
- (3) The recommendation by the ATO or the DTO shall be valid for 12 months. If the applicant has failed to take at least one theoretical knowledge examination paper within this validity period, the need for further training shall be determined by the ATO or the DTO, based on the needs of the applicant.

(c) Pass standards

- (1) A pass in a theoretical knowledge examination shall be awarded to the applicant when achieving at least 75 % of the marks allocated to that paper. No penalty marking shall be applied.
- (2) Unless otherwise specified in this Annex, an applicant is considered to have successfully completed the required theoretical knowledge examination for the SPL if he or she has passed all the required theoretical knowledge examination papers within a period of 18 months counted from the end of the calendar month when the applicant first attempted to take the examination.
- (3) If an applicant has failed to pass one of the theoretical knowledge examination papers within four attempts or has failed to pass all papers within the period mentioned in paragraph (2), he or she shall retake the complete set of theoretical knowledge examination papers.
- (4) Before retaking the theoretical knowledge examinations, the applicant shall undertake further training at an ATO or a DTO. The extent and scope of the training needed shall be determined by the ATO or the DTO, based on the needs of the applicant.

(d) Validity period

The successful completion of the theoretical knowledge examinations shall be valid for a period of 24 months, counted from the day when the applicant successfully completed the theoretical knowledge examination, in accordance with paragraph (c)(2).

AMC1 SFCL.135 SPL – Theoretical knowledge examinations

ED Decision 2020/004/R

- (a) The theoretical knowledge examinations for the SPL follow the syllabus for theoretical knowledge instruction for the SPL set out in [AMC1 SFCL.130](#).
- (b) The examinations should be in written form. However, for the subject Communications practical classroom testing may be conducted.
- (c) The examinations should comprise a total of 120 multiple-choice questions, covering all the subjects, with the following arrangements for questions and allocated time per subject:

Subject	Number of questions	Duration (in minutes)
Air law	20	40
Human performance	10	20
Meteorology	20	40
Communications	10	20
Navigation	20	75
Principles of flight*	10	20
Operational procedures*	10	20
Flight performance and planning*	10	20
Aircraft general knowledge*	10	20

* These four subjects may be combined in one single examination paper that comprises 10 questions per subject (40 in total) and has a duration of 80 minutes. In any case, the pass rate as per point SFCL.135(c)(1) needs to be achieved for each subject.

- (d) The period of 18 months mentioned in point [SFCL.135\(c\)\(2\)](#) should be counted from the end of the calendar month when the applicant first attempted an examination.
- (e) The competent authority should inform applicants of the language(s) in which the examination will be conducted.

GM1 SFCL.135 SPL – Theoretical knowledge examinations

ED Decision 2020/004/R

TERMINOLOGY

The meaning of the following terms used in [SFCL.135](#) is as follows:

- (a) ‘Entire set of examinations’: an examination in all subjects required by the licence level.
- (b) ‘Examination’: the demonstration of knowledge in one or more examination papers.
- (c) ‘Examination paper’: a set of questions that covers one subject required by the licence level, to be answered by a candidate for examination.
- (d) ‘Attempt’: a try to pass a specific examination paper.

SFCL.140 SPL – Crediting of theoretical knowledge

Regulation (EU) 2020/358

Applicants for the issue of an SPL shall be credited towards the theoretical knowledge requirements for the common subjects as specified in point [SFCL.135\(a\)\(1\)](#) if they:

- (a) hold a licence in accordance with Annex I (Part-FCL) to Regulation (EU) No 1178/2011 or with Annex III (Part-BFCL) to Regulation (EU) 2018/395; or
- (b) have passed the theoretical knowledge examinations for a licence as specified in paragraph (a), as long as this is done within the validity period specified in point SFCL.135(d).

SFCL.145 SPL – Practical skill test

Regulation (EU) 2020/358

- (a) Applicants for an SPL shall demonstrate through the completion of a skill test the ability to perform, as PIC on sailplanes, the relevant procedures and manoeuvres with competency appropriate to the privileges sought.
- (b) Applicants shall complete the skill test in a sailplane, excluding TMGs, or a TMG, depending on the privileges sought and provided that the training course in accordance with point [SFCL.130](#) included the necessary training elements for the relevant aircraft. An applicant who has completed a training course, including the necessary training elements for both sailplanes and TMGs, may complete 2 skill tests, 1 in a sailplane, excluding TMGs, and 1 in a TMG, in order to obtain privileges for both aircraft.
- (c) To take a skill test for the issue of an SPL the applicant shall first pass the required theoretical knowledge examinations.
- (d) Pass standards
 - (1) The skill test shall be divided into different sections, representing all the different phases of a sailplane flight.

- (2) Failure in any item of a section shall cause the applicant to fail the entire section. If the applicant fails in only one section, he or she shall repeat only that section. Failure in more than one section shall require the applicant to retake the entire test.
 - (3) If the applicant needs to retake the test in accordance with paragraph (2) and fails in any section, including those sections that have been passed at a previous attempt, the applicant shall retake the entire test.
- (e) If the applicant fails to achieve a pass in all sections of the test within two attempts he or she shall receive further practical training.

AMC1 SFCL.145 SPL – Practical skill test

ED Decision 2020/004/R

- (a) GENERAL
- (1) An applicant should be responsible for the flight planning and should ensure that all equipment and documentation for the execution of the flight are available.
 - (2) The applicant should indicate to the FE the checks and duties carried out.
Checks should be completed in accordance with the flight manual or the authorised checklist for the sailplane in which the test is being taken.
- (b) ADDITIONAL ARRANGEMENTS FOR SKILL TESTS IN TMGs
- (1) The route to be flown for the skill test should be chosen by the FE. The route should end at the point of departure or another aerodrome or operating site. The navigation section of the test should have a duration of at least 30 minutes which allows the pilot to demonstrate the ability to complete a route with at least two identified waypoints and may, as agreed between applicant and FE, be flown as a separate test.
 - (2) When indicating to the FE the checks and duties to be carried out, the applicant should include the identification of radio facilities that are intended to be used. During pre-flight preparation for the test, the applicant should be required to determine power settings and speeds. Performance data for take-off, approach and landing should be calculated by the applicant in compliance with the aircraft flight manual for the TMG used.
- (c) FLIGHT TEST TOLERANCE
- (1) The applicant should demonstrate the ability to:
 - (i) operate the sailplane within its limitations;
 - (ii) complete all manoeuvres with smoothness and accuracy;
 - (iii) exercise good judgment and airmanship;
 - (iv) apply aeronautical knowledge; and
 - (v) maintain control of the sailplane at all times in such a manner that the successful outcome of a procedure or manoeuvre is never seriously in doubt.
 - (2) In the case of skill tests in TMGs, the following limits are for general guidance. The FE should make allowance for turbulent conditions and the handling qualities and performance of the TMG used:
 - (i) height: normal flight \pm 150 ft

- (ii) speed:
 - (A) take-off and approach +15/-5 knots
 - (B) all other flight regimes \pm 15 knots

(d) CONTENT OF THE SKILL TEST

- (1) The following skill test contents and sections should be used for the skill test for the issue of an SPL in a sailplane, excluding TMGs:

Note: Use of checklist(s), airmanship, control of sailplane by external visual reference, look-out procedures etc. apply in all sections.

SECTION 1: PRE-FLIGHT OPERATIONS AND DEPARTURE	
a	Pre-flight sailplane (daily) inspection, documentation, flight planning, NOTAM(s) and weather briefing
b	Verifying in-limits mass and balance and performance calculation
c	Sailplane servicing compliance
d	Pre-take-off checks
Note for SECTION 2A-2C: At least for one of the three launch methods, all the mentioned items are fully exercised during the skill test.	
SECTION 2A: WINCH OR CAR LAUNCH	
a	Signals before and during launch, including messages to winch driver
b	Adequate profile of winch launch
c	Simulated launch failure (during launch or in free flight)
d	Situational awareness
SECTION 2B: AEROTOW LAUNCH	
a	Signals before and during launch, including signals to or communications with the tow plane pilot for any problems
b	Initial roll and take-off climb
c	Launch abandonment (simulation only or 'talk-through')
d	Correct positioning during straight flight and turns
e	Out of position and recovery
f	Correct release from tow
g	Look-out and airmanship through the whole launch phase
SECTION 2C: SELF-LAUNCH (powered sailplanes only)	
a	ATC compliance (if applicable)
b	Aerodrome departure procedures
c	Initial roll and take-off climb
d	Look-out and airmanship during the whole take-off
e	Simulated engine failure after take-off
f	Engine shut down and stowage
SECTION 3: GENERAL AIRWORK	
a	Maintain straight flight: attitude and speed control
b	Coordinated medium (30 ° bank) turns, look-out procedures and collision avoidance
c	Turning on to selected headings visually and with use of compass
d	Flight at high angle of attack (critically low air speed)
e	Clean stall and recovery

f	Spin avoidance and recovery*
g	Steep (45 ° bank) turns, look-out procedures and collision avoidance
h	Local area navigation and awareness

SECTION 4: CIRCUIT, APPROACH AND LANDING

a	Aerodrome circuit joining procedure
b	Collision avoidance: look-out procedures
c	Pre-landing checks
d	Circuit, approach control and landing
e	Precision landing (simulation of out-landing and short field)
f	Crosswind landing if suitable conditions are available

(*) If no suitable training aircraft is available to demonstrate the fully developed spin including spin recovery, or if such spin manoeuvres cannot be performed due to bad weather constraints, the applicant should demonstrate the competence in all the aspects related to this exercise during a discussion with the examiner.

- (2) The following skill test contents and sections should be used for the skill test for the issue of an SPL in a TMG:

Note: Use of checklist(s), airmanship, control of TMG by external visual reference, de-icing procedures, etc. apply in all sections.

SECTION 1: PRE-FLIGHT OPERATIONS AND DEPARTURE

a	Pre-flight documentation, flight planning, NOTAM(s) and weather briefing
b	Mass and balance and performance calculation
c	TMG inspection and servicing
d	Engine starting and after starting procedures
e	Taxiing and aerodrome procedures, pre-take-off procedures
f	Take-off and after take-off checks
g	Aerodrome departure procedures
h	ATC liaison: compliance

SECTION 2A: GENERAL AIRWORK (WITH ENGINE POWER)

a	ATC liaison
b	Straight and level flight, with speed changes
c	Climbing: <ol style="list-style-type: none"> i. best rate of climb; ii. climbing turns; and iii. levelling off.
d	Medium (30 ° bank) turns, look-out procedures and collision avoidance
e	Steep (45 ° bank) turns
f	Flight at critically low air speed with and without flaps
g	Stalling: <ol style="list-style-type: none"> i. clean stall and recover with power; ii. approach to stall descending turn with bank angle 20 °, approach configuration; and iii. approach to stall in landing configuration.
h	Descending: <ol style="list-style-type: none"> i. with and without power; ii. descending turns (steep gliding turns); and

	iii. levelling off.
SECTION 2B: GENERAL AIRWORK (WITHOUT ENGINE POWER)	
a	Straight and level flight, with speed changes
b	Medium (30 ° bank) turns, look-out procedures and collision avoidance
c	In-flight engine start and stop procedures
d	Stall in turns
SECTION 3: EN-ROUTE PROCEDURES	
a	Flight plan, dead reckoning and map reading
b	Maintenance of altitude, heading and speed
c	Orientation, airspace structure, timing and revision of estimated times of arrival (ETAs), log keeping
d	Diversion to alternate aerodrome (planning and implementation)
e	Flight management (checks, fuel systems, carburettor icing, etc.)
f	ATC liaison: compliance
SECTION 4: APPROACH AND LANDING PROCEDURES	
a	Aerodrome arrival procedures
b	Collision avoidance (look-out procedures)
c	Precision landing (short field landing) and crosswind, if suitable conditions are available
d	Flapless landing (if applicable)
e	Approach to landing with idle power
f	Touch and go
g	Go-around from low height
h	ATC liaison
i	Actions after flight
SECTION 5: ABNORMAL AND EMERGENCY PROCEDURES	
This section may be combined with Sections 1 through 4.	
a	Simulated engine failure after take-off
b	* Simulated forced landing
c	* Simulated precautionary landing
d	Simulated emergencies
e	Oral questions

* These items may be combined, at the discretion of the FE.

SFCL.150 SPL – Sailplane and TMG privileges

Regulation (EU) 2020/358

- (a) If the skill test as specified in point [SFCL.145](#) has been completed in a sailplane, excluding TMGs, the privileges of an SPL shall be limited to sailplanes, excluding TMGs.
- (b) In the case specified in paragraph (a), the privileges of an SPL shall be extended to TMGs upon application if a pilot has:
- (1) completed at an ATO or a DTO the training elements specified in point [SFCL.130\(a\)\(2\)\(v\)](#);
 - (2) passed a skill test to demonstrate an adequate level of practical skill in a TMG. During this skill test, the applicant shall also demonstrate to the examiner an adequate level of theoretical knowledge for TMGs in the following subjects:

- (i) principles of flight;
 - (ii) operational procedures;
 - (iii) flight performance and planning;
 - (iv) aircraft general knowledge; and
 - (v) navigation.
- (c) Holders of a licence issued in accordance with Annex I (Part-FCL) to Regulation (EU) No 1178/2011 shall receive full credit towards the requirements in paragraph (b) provided that they:
- (1) hold a class rating for TMGs; or
 - (2) have TMG privileges and comply with the recency requirements in point FCL.140.A of Annex I (Part-FCL) to Regulation (EU) No 1178/2011.
- (d) If the skill test as specified in point [SFCL.145](#) has been completed in a TMG, the privileges of the SPL shall be limited to TMGs.
- (e) In the case specified in paragraph (d), the privileges of the SPL shall be extended to sailplanes upon application if a pilot has:
- (1) completed at an ATO or a DTO the training elements specified in point [SFCL.130\(a\)\(2\)\(iv\)](#) and at least 15 launches and landings in a sailplane, excluding TMGs; and
 - (2) passed a skill test to demonstrate an adequate level of practical skill in a sailplane, excluding TMGs. During this skill test, the pilot shall also demonstrate to the examiner an adequate level of theoretical knowledge for sailplanes, excluding TMGs, in the following subjects:
 - (i) principles of flight;
 - (ii) operational procedures;
 - (iii) flight performance and planning;
 - (iv) aircraft general knowledge; and
 - (v) navigation.
- (f) The completion of the training as specified in paragraphs (b)(1) and (e)(1) shall be entered in the logbook of the pilot and signed by the head of training of the ATO or the DTO that is responsible for the training.

AMC1 SFCL.150(b) SPL – Sailplane and TMG privileges

ED Decision 2020/004/R

EXTENSION TO TMG PRIVILEGES

- (a) Once the training set out in this AMC is completed, the ATO or the DTO should issue a certificate of satisfactory completion of the training.
- (b) Theoretical knowledge

In preparation for the demonstration of additional theoretical knowledge as stipulated in point SFCL.150(b)(2), the training course at an ATO or at an DTO should include theoretical knowledge instruction that should at least cover the revision or explanation of:

-
- (1) Principles of flight
 - (i) operating limitations (addition: TMG);
 - (ii) propellers; and
 - (iii) flight mechanics.
 - (2) Operational procedures for TMGs
 - (i) special operational procedures and hazards; and
 - (ii) emergency procedures.
 - (3) Flight performance and planning
 - (i) mass and balance considerations;
 - (ii) loading;
 - (iii) CG calculation;
 - (iv) load and trim sheet;
 - (v) performance of TMGs;
 - (vi) flight planning for VFR flights;
 - (vii) fuel planning;
 - (viii) pre-flight preparation;
 - (ix) ICAO flight plan; and
 - (x) flight monitoring and in-flight re-planning.
 - (4) Aircraft general knowledge
 - (i) system designs, loads, stresses, maintenance;
 - (ii) airframe;
 - (iii) landing gear, wheels, tyres, brakes;
 - (iv) fuel system;
 - (v) electrics;
 - (vi) piston engines;
 - (vii) propellers; and
 - (viii) instrument and indication systems.
 - (5) Navigation
 - (i) dead reckoning navigation (addition: powered flying elements);
 - (ii) in-flight navigation (addition: powered flying elements);
 - (iii) basic radio propagation theory;
 - (iv) radio aids (basics);
 - (v) radar (basics); and
 - (vi) GNSS.

(c) Flight instruction

- (1) The numbering of exercises should be used primarily as an exercise reference list and as a broad instructional sequencing guide; therefore, the demonstrations and practices need not necessarily be given in the order listed.
- (2) The training elements as per point SFCL.150(b)(1) should cover the revision or explanation of the following exercises:

Exercise 1: Familiarisation with the TMG

- (i) characteristics of the TMG;
- (ii) cockpit layout;
- (iii) systems; and
- (iv) checklists, drills and controls.

Exercise 1e: Emergency drills

- (i) action if fire on the ground and in the air;
- (ii) engine cabin and electrical system fire;
- (iii) systems failure; and
- (iv) escape drills, location and use of emergency equipment and exits.

Exercise 2: Preparation for and action after flight

- (i) serviceability documents;
- (ii) equipment required, maps, etc.;
- (iii) external checks;
- (iv) internal checks;
- (v) harness and seat or rudder panel adjustments;
- (vi) starting and warm-up checks;
- (vii) power checks;
- (viii) running down system checks and switching off the engine;
- (ix) parking, security and picketing (for example, tie down); and
- (x) completion of authorisation sheet and serviceability documents.

Exercise 3: Taxiing

- (i) pre-taxi checks;
- (ii) starting, control of speed and stopping;
- (iii) engine handling;
- (iv) control of direction and turning;
- (v) turning in confined spaces;

- (vi) parking area procedure and precautions;
- (vii) effects of wind and use of flying controls;
- (viii) effects of ground surface;
- (ix) freedom of rudder movement;
- (x) marshalling signals;
- (xi) instrument checks;
- (xii) air traffic control procedures (if applicable).

Exercise 3e: Emergencies: brake and steering failure**Exercise 4: Straight and level**

- (i) at normal cruising power, attaining and maintaining straight and level flight;
- (ii) flight at critically high air speeds;
- (iii) demonstration of inherent stability;
- (iv) control of pitch, including use of trim;
- (v) lateral level, direction and balance and trim;
- (vi) at selected air speeds (use of power);
- (vii) during speed and configuration changes; and
- (viii) use of instruments for precision.

Exercise 5: Climbing

- (i) entry, maintaining the normal and max rate climb and levelling off;
- (ii) levelling off at selected altitudes;
- (iii) en-route climb (cruise climb);
- (iv) climbing with flap down (if available);
- (v) recovery to normal climb;
- (vi) maximum angle of climb; and
- (vii) use of instruments for precision.

Exercise 6: Descending

- (i) entry, maintaining and levelling off;
- (ii) levelling off at selected altitudes;
- (iii) glide, powered and cruise descent (including effect of power and air speed);
- (iv) side slipping (on suitable types);
- (v) use of instruments for precision flight; and
- (vi) descending with engine inoperative.

Exercise 7: Turning

- (i) entry and maintaining medium level turns;
- (ii) resuming straight flight;
- (iii) faults in the turn (incorrect pitch, bank and balance);
- (iv) climbing turns;
- (v) descending turns;
- (vi) slipping turns (on suitable types);
- (vii) turns onto selected headings, use of gyro heading indicator or compass; and
- (viii) use of instruments for precision.

Exercise 8a: Slow flight

Note: The objective is to improve the pilot's ability to recognise inadvertent flight at critically low speeds and provide practice in maintaining the TMG in balance while returning to normal air speed.

- (i) safety checks;
- (ii) introduction to slow flight;
- (iii) controlled flight down to critically slow air speed; and
- (iv) application of full power with correct attitude and balance to achieve normal climb speed.

Exercise 8b: Stalling

- (i) airmanship;
- (ii) safety checks;
- (iii) symptoms;
- (iv) recognition;
- (v) clean stall and recovery without power and with power;
- (vi) recovery when a wing drops; and
- (vii) approach to stall in the approach and in the landing configurations, with and without power, recovery at the incipient stage.

Exercise 9: Take-off and climb to downwind position

- (i) pre-take-off checks;
- (ii) into wind take-off;
- (iii) safeguarding the nose wheel (if applicable);
- (iv) crosswind take-off;
- (v) drills during and after take-off;

- (vi) short take-off and soft field procedure or techniques including performance calculations; and
- (vii) noise abatement procedures.

Exercise 10: Circuit, approach and landing

- (i) circuit procedures, downwind and base leg;
- (ii) approach and landing with and without (idle) engine power;
- (iii) safeguarding the nose wheel (if applicable);
- (iv) effect of wind and wind shear on approach and touchdown speeds;
- (v) use of airbrakes, flaps, slats or spoilers (if available);
- (vi) crosswind approach and landing;
- (vii) glide approach and landing (engine stopped);
- (viii) short landing and soft field procedures or techniques;
- (ix) flapless approach and landing (if applicable);
- (x) wheel landing;
- (xi) missed approach and go-around; and
- (xii) noise abatement procedures.

Note: In the interests of safety, it will be necessary for pilots who are trained on nose wheel TMGs to undergo dual conversion training before flying tail wheel TMGs, and vice versa.

Exercise 9/10e: Emergencies

- (i) abandoned take-off;
- (ii) engine failure after take-off;
- (iii) mislanding and go-around; and
- (iv) missed approach.

Exercise 11: Advanced turning

- (i) steep turns (45 °), level and descending;
- (ii) stalling in the turn and recovery; and
- (iii) recoveries from unusual attitudes, including spiral dives.

Exercise 12: Stopping and restarting the engine

- (i) engine cooling procedures;
- (ii) switching off procedure in-flight;
- (iii) sailplane operating procedures;

- (iv) restarting procedure; and
- (v) decision process to start or not start the engine.

Exercise 13: Forced landing without power

- (i) forced landing procedure;
- (ii) choice of landing area, provision for change of plan;
- (iii) gliding distance;
- (iv) descent plan;
- (v) key positions;
- (vi) engine failure checks;
- (vii) use of radio;
- (viii) base leg;
- (ix) final approach;
- (x) landing; and
- (xi) actions after landing.

Exercise 14: Precautionary landing

- (i) full procedure away from aerodrome to break-off height;
- (ii) occasions necessitating;
- (iii) in-flight conditions;
- (iv) landing area selection:
 - (A) normal aerodrome;
 - (B) disused aerodrome; and
 - (C) ordinary field;
- (v) circuit and approach; and
- (vi) actions after landing.

Exercise 15a: Navigation

- (i) Flight planning
 - (A) weather forecast and actuals;
 - (B) map selection and preparation:
 - (1) choice of route;
 - (2) airspace structure; and
 - (3) safety altitudes;
 - (C) calculations:

- (1) magnetic heading(s) and time(s) en-route;
- (2) fuel consumption;
- (3) mass and balance; and
- (4) mass and performance;
- (D) flight information:
 - (1) NOTAMs, etc.;
 - (2) radio frequencies; and
 - (3) selection of alternate aerodromes;
- (E) TMG documentation;
- (F) notification of the flight:
 - (1) pre-flight administrative procedures; and
 - (2) ICAO flight plan form;
- (ii) Departure:
 - (A) organisation of cockpit workload;
 - (B) departure procedures:
 - (1) altimeter settings;
 - (2) ATC liaison in regulated airspace (may be simulated in case of unavailability of regulated airspace);
 - (3) setting heading procedure; and
 - (4) noting of ETAs;
- (iii) En-route:
 - (A) maintenance of altitude and heading;
 - (B) revisions of ETAs and heading;
 - (C) log keeping;
 - (D) use of radio or compliance with ATC procedures;
 - (E) minimum weather conditions for continuation of flight;
 - (F) in-flight decisions;
 - (G) transiting controlled or regulated airspace;
 - (H) diversion procedures;
 - (I) uncertainty of position procedure; and
 - (J) lost procedure; and
- (iv) Arrival, aerodrome joining procedure:
 - (A) ATC liaison in regulated airspace (may be simulated in case of unavailability of regulated airspace);
 - (B) altimeter setting;

- (C) entering the traffic pattern;
- (D) circuit procedures;
- (E) parking;
- (F) security of TMG;
- (G) refuelling;
- (H) closing of flight plan, if appropriate; and
- (I) post-flight administrative procedures.

Exercise 15b: Navigation problems at lower levels and in reduced visibility

- (i) actions before descending;
- (ii) hazards (for example, obstacles and terrain);
- (iii) difficulties of map reading;
- (iv) effects of wind and turbulence;
- (v) vertical situational awareness (avoidance of controlled flight into terrain);
- (vi) avoidance of noise sensitive areas;
- (vii) joining the circuit; and
- (viii) bad weather circuit and landing.

Exercise 15c: Radio navigation (basics)

- (i) Use of GNSS or VOR/NDB:
 - (A) selection of waypoints;
 - (B) to or from indications or orientation; and
 - (C) error messages;
- (ii) Use of VHF/DF and other radio facilities, as available:
 - (A) availability, AIP and frequencies;
 - (B) R/T procedures and ATC liaison; and
 - (C) obtaining a QDM and homing; and
- (iii) Use of en-route or terminal radar:
 - (A) availability and AIP;
 - (B) procedures and ATC liaison;
 - (C) pilot's responsibilities; and
 - (D) secondary surveillance radar:
 - (1) transponders;
 - (2) code selection; and
 - (3) interrogation and reply.

GM1 SFCL.150(c) SPL – Sailplane and TMG privileges

ED Decision 2020/004/R

FAMILIARISATION WITH ENGINE START/STOP PROCEDURES

SPL holders who obtain TMG privileges through a credit in accordance with point [SFCL.150\(c\)](#) should make themselves familiar with the procedures set out in the aircraft flight manual (AFM) for starting and stopping the engine in flight.

AMC1 SFCL.150(e) SPL – Sailplane and TMG privileges

ED Decision 2020/004/R

EXTENSION TO SAILPLANE PRIVILEGES

(a) Once the training set out in this AMC is completed, the ATO or the DTO should issue a certificate of satisfactory completion of the training.

(b) Theoretical knowledge

In preparation for the demonstration of additional theoretical knowledge as stipulated in point [SFCL.150\(e\)\(2\)](#), the training course at an ATO or at an DTO should include theoretical knowledge instruction that should at least cover the revision or explanation of:

(1) Principles of flight

Operating limitations

(2) Operational procedures

(i) special operational procedures and hazards; and

(ii) emergency procedures.

(3) Flight performance and planning

(i) mass and balance considerations;

(ii) loading;

(iii) CG calculation;

(iv) load and trim sheet; and

(v) performance of sailplanes.

(4) Aircraft general knowledge

(i) system designs, loads, stresses, maintenance;

(ii) airframe;

(iii) landing gear, wheels, tyres, brakes; and

(iv) instrument and indication systems.

(5) Navigation

(i) dead reckoning navigation (addition: powered flying elements);

(ii) in-flight navigation; and

(iii) GNSS.

(c) Flight instruction

The flight instruction should include at least the training syllabus specified in point (c) of [AMC2 SFCL.130](#). However, credit may be given for exercises 4 to 8, 10 and 14.

SFCL.155 SPL – Launching methods

Regulation (EU) 2020/358

- (a) SPL holders shall exercise their privileges only by using those launching methods for which they have completed a specific training either during the training course in accordance with point [SFCL.130](#) or point SFCL.150(e)(1) or during additional training provided by an instructor after the issue of the SPL. This specific training shall consist of the following:
 - (1) in the case of winch launch and car launch, a minimum of 10 launches in dual flight instruction, and five solo launches under supervision;
 - (2) in the case of aerotow or self-launch, a minimum of five launches in dual flight instruction, and five solo launches under supervision. In the case of self-launch, dual flight instruction may be conducted in TMGs;
 - (3) in the case of bungee launch, a minimum of three launches performed in dual flight instruction or solo under supervision; and
 - (4) in case of further launching methods, training as required by the competent authority.
- (b) The completion of the training as specified in paragraph (a) shall be entered in the logbook of the pilot and signed by the head of training of the ATO or the DTO or the instructor that is responsible for the training, as applicable.
- (c) In order to maintain the privileges for each launching method and in accordance with the requirements of paragraphs (a) and (b), SPL holders shall complete a minimum of five launches during the last two years, except for bungee launch, in which case they shall complete only two launches. In the case of self-launch, launches may be done in self-launch or through take-offs in TMGs or a combination of these.
- (d) If SPL holders do not comply with the requirement in paragraph (c), in order to renew their privileges they shall perform the additional number of launches flying dual or solo under the supervision of an instructor.

AMC1 SFCL.155(a)(2) SPL – Launching methods

ED Decision 2020/004/R

INSTRUCTION FOR SELF-LAUNCH

- (a) The training for the self-launch method should include the syllabus for self-launch set out in point (c)(5) of [AMC2 SFCL.130](#) (Exercise 11c).
- (c) At the end of the training, the applicant should demonstrate to the instructor the ability to perform all of the following:
 - (1) a self-launch;
 - (2) appropriate actions in the event of engine failures; and
 - (3) the decision processes referred to in items (xix) and (xx) of Exercise 11c in point (c)(5) of [AMC2 SFCL.130](#).

GM1 SFCL.155(a)(4) SPL – Launching methods

ED Decision 2020/004/R

FURTHER LAUNCHING METHODS

In addition to the launching methods specified in points (b)(1) to (b)(3) of point [SFCL.155](#), further launching methods (e.g. ‘gravity launch’ – launching the sailplane by running it down a slope) may be practised in some Member States. Such additional launching methods can be exercised, after applicants have complied with specific training requirements as established by the competent authority.

SFCL.160 SPL – Recency requirements

Regulation (EU) 2020/358

- (a) Sailplanes, excluding TMGs SPL holders shall exercise SPL privileges, excluding TMGs, only if in the last 24 months before the planned flight they:
 - (1) completed, on sailplanes, at least five hours of flight time as PIC or flying dual or solo under the supervision of an FI(S), including, on sailplanes, excluding TMGs, at least:
 - (i) 15 launches; and
 - (ii) two training flights with an FI(S); or
 - (2) passed a proficiency check with an FE(S) on a sailplane, excluding TMGs; the proficiency check shall be based on the skill test for SPL.
- (b) TMGs SPL holders shall exercise their TMG privileges only if in the last 24 months before the planned flight they:
 - (1) completed at least 12 hours of flight time as PIC or flying dual or solo under the supervision of an FI(S), including, on TMGs, at least:
 - (i) six hours flight time;
 - (ii) 12 take-offs and landings; and
 - (iii) a training flight of at least one hour total flight time with an instructor; or
 - (2) passed a proficiency check with an examiner; the proficiency check shall be based on the skill test as specified in point [SFCL.150\(b\)\(2\)](#).
- (c) SPL holders with privileges to fly on TMGs who also hold a licence including the privileges to fly on TMGs in accordance with the provisions of Annex I (Part-FCL) to Regulation (EU) No 1178/2011 shall be exempted from complying with paragraph (b).
- (d) The completion of the dual flights, the flights under supervision and the training flights as specified in paragraphs (a)(1) and (b)(1), as well as the proficiency checks as specified in paragraph (a)(2) and (b)(2) shall be entered in the logbook of the pilot and signed by the responsible FI(S) in the case of paragraphs (a)(1) and (b)(1), and by the responsible FE(S) in the case of paragraphs (a)(2) and (b)(2).
- (e) Carriage of passengers SPL holders shall carry passengers only if in the preceding 90 days they have carried out as PIC, at least:
 - (1) three launches in sailplanes, excluding TMGs, if passengers are to be carried in sailplanes, excluding TMGs; or

- (2) three take-offs and landings in TMGs, if passengers are to be carried in a TMG. For carrying passengers at night in a TMG, at least one of those take-offs and landings shall be carried out at night.

AMC1 SFCL.160 SPL – Recency requirements

ED Decision 2020/004/R

CREDITS FOR FLIGHT TIME COMPLETED ON SAILPLANES AS PER ARTICLE 2(8) OF AS WELL AS ANNEX I TO THE BASIC REGULATION

All hours flown on sailplanes that are subject to a decision as per Article 2(8) of the Basic Regulation or that are specified in Annex I to the Basic Regulation should count in full towards fulfilling the hourly requirements of point [SFCL.160](#) of Part-SFCL under the following conditions:

- (a) the sailplane matches the definition and criteria of the respective Part-SFCL sailplane or TMG, as applicable;
- (b) a sailplane that is used for a training flight with an instructor is an aircraft as per points (a), (b), (c) or (d) of Annex I to the Basic Regulation that is subject to an authorisation specified in point ORA.ATO.135 of Annex VII (Part-ORA) or point DTO.GEN.240 of Annex VIII (Part-DTO) to Regulation (EU) No 1178/2011.

AMC1 SFCL.160(a)(1)(ii) SPL – Recency requirements

ED Decision 2020/004/R

TRAINING FLIGHTS

- (a) The content of the two training flights, as stipulated in point SFCL.160(a)(1)(ii), should include elements from the skill test for the SPL, as set out in AMC1 SFCL.145, selected by the instructor in accordance with point (b).
- (b) Each training flight should be preceded with a briefing and closed with a debriefing between the instructor and the candidate. In order to add value to the training flight, any element of flying a sailplane where candidates feel they would benefit from instruction should be discussed. The flight should then be focused on those specific elements with an instructor demonstration prior to candidate practice being performed.
- (c) If the instructor considers that the candidate during the training flight did not perform to an adequate standard, they should not sign the logbook of the candidate but recommend further training flights instead.
- (d) The 24-month period should be counted from the last day of the month in which the respective training flight took place.

AMC1 SFCL.160(e) Recency requirements

ED Decision 2020/004/R

RECENT EXPERIENCE FOR THE CARRIAGE OF PASSENGERS

When a pilot needs to carry out one or more flights with an instructor or an examiner in order to comply with the requirement of point [SFCL.160\(e\)](#) before the pilot can carry passengers, the instructor or examiner on board those flights will not be considered as a passenger.

SUBPART ADD – ADDITIONAL RATINGS AND PRIVILEGES

SFCL.200 Aerobatic privileges

Regulation (EU) 2020/358

- (a) SPL holders shall only undertake aerobatic flights in sailplanes with any engine stopped, or, in the case of paragraph (d) and (e), with engine power, if they hold the appropriate aerobatic privileges in accordance with this point.
- (b) Basic aerobatic privileges:
- (1) entitle its holder to undertake aerobatic flights limited to the following manoeuvres:
 - (i) 45-degree climbing and diving lines performed as aerobatic manoeuvres;
 - (ii) inside loops;
 - (iii) wingover;
 - (iv) lazy eight;
 - (v) spins;
 - (2) are included in the privileges of an SPL after a pilot has completed:
 - (i) after the issue of the SPL, at least 30 hours of flight time or 120 launches as PIC on sailplanes;
 - (ii) a training course at an ATO or a DTO, including:
 - (A) theoretical knowledge instruction appropriate for the privileges sought;
 - (B) aerobatic flight instruction on the manoeuvres specified in paragraph (1).
- (c) Advanced aerobatic privileges:
- (1) entitle its holder to undertake aerobatic flights not limited to manoeuvres as specified in paragraph (b)(1);
 - (2) are included in the privileges of an SPL after a pilot has:
 - (i) complied with the requirements of paragraph (b)(2)(i);
 - (ii) completed a training course at an ATO or a DTO, including:
 - (A) theoretical knowledge instruction appropriate for the privileges sought;
 - (B) at least five hours or 20 flights of aerobatic flight instruction.
- (d) The basic or advanced aerobatic privileges shall include aerobatic flights in sailplanes with engine power, if a pilot has received a training in aerobatic flight in sailplanes with engine power during a training course in accordance with paragraphs (b)(2)(ii) or (c)(2)(ii), as applicable.
- (e) The privileges of an SPL shall include advanced aerobatic privileges for TMGs flown with engine power if a pilot also has or has had an aerobatic rating in accordance with point FCL.800 of Annex I (Part-FCL) to Regulation (EU) No 1178/2011, including privileges for aerobatic flight on TMGs.
- (f) The completion of the training course as specified in paragraphs (b)(2)(ii) and (c)(2)(ii) and, as applicable, the inclusion of training specified in paragraph (d), shall be entered in the logbook and signed by the head of training of the ATO or the DTO that is responsible for the training.

AMC1 SFCL.200(b) Aerobatic privileges

ED Decision 2020/004/R

TRAINING FOR THE BASIC AEROBATIC PRIVILEGES

(a) The aim of the basic aerobatic training is to qualify SPL holders to perform the aerobatic manoeuvres specified in point [SFCL.200\(b\)\(1\)](#).

(b) Theoretical knowledge

The syllabus for the theoretical knowledge instruction as per point [SFCL.200\(b\)\(2\)\(ii\)\(A\)](#) should cover at least all of the following:

(1) human factors and body limitations

- (i) spatial disorientation;
- (ii) airsickness;
- (iii) body stress and G-forces, positive and negative; and
- (iv) effects of grey- and blackouts.

(2) technical subjects

- (i) legislation affecting aerobatic flying to include environmental and noise subjects;
- (ii) principles of aerodynamics to include slow flight, stalls and spins, flat and inverted; and
- (iii) general airframe and engine limitations (if applicable).

(3) limitations applicable to the specific aircraft category (and type)

- (i) air speed limitations (sailplane);
- (ii) symmetric load factors (type-related, as applicable); and
- (iii) rolling Gs (type-related, as applicable).

(4) aerobatic manoeuvres and recovery

- (i) entry parameters;
- (ii) planning systems and sequencing of manoeuvres;
- (iii) rolling manoeuvres;
- (iv) looping manoeuvres;
- (v) combination manoeuvres; and
- (vi) entry and recovery from developed spins, flat, accelerated and inverted.

(5) emergency procedures

- (i) recovery from unusual attitudes; and
- (ii) drills to include the use of parachutes (if worn) and aircraft abandonment.

(d) Flying training

The exercises of the basic aerobatic flying training syllabus should be repeated as necessary until the applicant achieves a safe and competent standard. Having completed the flight training, the student pilot should be able to perform a solo flight containing the manoeuvres

specified in point [SFCL.200\(b\)\(1\)](#). The dual training and the supervised solo training flights should be limited to the permitted manoeuvres of the type of sailplane used. The exercises should comprise at least the following practical training items:

- (1) confidence manoeuvres and recoveries
 - (i) slow flights and stalls;
 - (ii) steep turns;
 - (iii) side slips;
 - (iv) engine restart in-flight (if applicable);
 - (v) spins and recovery;
 - (vi) recovery from spiral dives; and
 - (vii) recovery from unusual attitudes.
- (2) aerobatic manoeuvres as per point [SFCL.200\(b\)\(1\)](#).

AMC1 SFCL.200(c) Aerobatic privileges

ED Decision 2020/004/R

TRAINING FOR THE ADVANCED AEROBATIC PRIVILEGES

- (a) The aim of the advanced aerobatic training is to qualify SPL holders to perform aerobatic manoeuvres.
- (b) Theoretical knowledge

The syllabus for the theoretical knowledge instruction as per point [SFCL.200\(c\)\(2\)\(ii\)\(A\)](#) should cover at least the elements specified in point (b) of [AMC1 SFCL.200\(b\)](#).

- (c) Flying training

The exercises of the advanced aerobatic flying training syllabus should be repeated as necessary until the applicant achieves a safe and competent standard. Having completed the flight training, the student pilot should be able to perform a solo flight containing a sequence of aerobatic manoeuvres. The dual training and the supervised solo training flights should be limited to the permitted manoeuvres of the type of sailplane used. The exercises should comprise at least the following practical training items:

- (1) confidence manoeuvres and recoveries as specified in point (d)(1) of [AMC1 SFCL.200\(b\)](#);
- (2) aerobatic manoeuvres:
 - (i) Chandelle;
 - (ii) Lazy Eight;
 - (iii) rolls;
 - (iv) loops;
 - (v) inverted flight;
 - (vi) Hammerhead turn; and
 - (vii) Immelmann.

- (d) For applicants who already hold basic aerobatic privileges as per point [SFCL.200\(b\)](#), the theoretical knowledge instruction as per point (b) may consist of a repetition of the elements specified in point (b) of [AMC1 SFCL.200\(b\)](#), and the flying training as per point (c) may focus on the aerobatic manoeuvres that are outside the scope of the basic aerobatic privileges.

AMC1 SFCL.200(d) Aerobatic privileges

ED Decision 2020/004/R

TRAINING FOR AEROBATIC FLIGHT WITH ENGINE POWER

Applicants who seek privileges for aerobatic flights with engine power in accordance with point [SFCL.200\(d\)](#) should complete, under engine power, all manoeuvres specified in point (d) of [AMC1 SFCL.200\(b\)](#) or point (c) of [AMC1 SFCL.200\(c\)](#), as applicable, that can be completed with engine power.

AMC1 SFCL.200(e) Aerobatic privileges

ED Decision 2020/004/R

CREDITS FOR AEROBATIC RATING AS PER REGULATION (EU) No 1178/2011

SPL holders who wish to make use of the credit established in point [SFCL.200\(e\)](#) should, when exercising aerobatic privileges, carry one of the following:

- (a) the aeroplane licence with the aerobatic rating, issued in accordance with Part-FCL; and
- (b) a confirmation (e.g. logbook entry) by the competent authority that an aerobatic rating in accordance with Part-FCL is or was held.

SFCL.205 Sailplane towing and banner towing rating

Regulation (EU) 2020/358

- (a) SPL holders who have privileges to fly TMGs shall tow sailplanes or banners only if they hold an appropriate sailplane towing or banner towing rating in accordance with this point.
- (b) Applicants for a sailplane towing rating shall have completed:
 - (1) at least 30 hours of flight time as PIC and 60 take-offs and landings in TMGs, after obtaining TMG privileges;
 - (2) a training course at an ATO or a DTO, including:
 - (i) theoretical knowledge instruction on sailplane towing operations and procedures;
 - (ii) at least 10 training flights towing a sailplane, including at least 5 dual training flights;
 - (iii) in the case of an SPL holder with privileges restricted to TMG in accordance with point [SFCL.150\(d\)](#), five familiarisation flights in a sailplane which is launched by an aircraft.
- (c) Applicants for a banner towing rating shall have completed:
 - (1) at least 100 hours of flight time and 200 take-offs and landings as PIC on TMGs, after obtaining TMG privileges;
 - (2) a training course at an ATO or a DTO, including:
 - (i) theoretical knowledge instruction on banner towing operations and procedures;

- (ii) at least 10 instruction flights towing a banner, including at least five dual flights.
- (d) Applicants for a sailplane towing rating or a banner towing rating in accordance with this point who already hold a sailplane towing or banner towing rating in accordance with point FCL.805(b) of Annex I (Part-FCL) to Regulation (EU) No 1178/2011 or who have fulfilled all the requirements for the issue of that rating, as applicable, shall:
 - (1) receive full credit towards the requirements in paragraph (b) or (c) for obtaining the sailplane towing or the banner towing rating, as applicable, if their relevant towing rating as specified in paragraph (d) includes privileges for towing with TMGs; or
 - (2) have completed at least three dual instruction flights covering the full sailplane towing or banner towing training syllabus, as applicable, in TMGs.
- (e) The completion of the training course as specified in paragraphs (b)(2), (c)(2) and (d)(2) shall be entered in the logbook and signed by the head of training of the ATO or the DTO or the instructor who is responsible for the training, as applicable.
- (f) To exercise the privileges of the sailplane towing or banner towing rating, the holder of the rating shall complete a minimum of five tows during the last two years.
- (g) If a holder of the sailplane towing rating does not comply with the requirement in paragraph (f), before resuming the exercise of his or her privileges, he or she shall complete the missing tows with or under the supervision of an instructor.

AMC1 SFCL.205 Sailplane towing and banner towing rating

ED Decision 2020/004/R

TRAINING FOR THE SAILPLANE TOWING AND BANNER TOWING RATING

(a) General

The aim of the towing instruction is to qualify SPL holders with TMG privileges to tow a sailplane or a banner. The theoretical knowledge and flight instruction should cover the relevant elements as set out in this AMC.

(b) Theoretical knowledge: towing of sailplanes

The theoretical knowledge syllabus for towing of sailplanes should cover the revision or explanation of:

- (1) regulations about towing flights;
- (2) equipment for the towing activity;
- (3) sailplane towing techniques, including:
 - (i) signals and communication procedures;
 - (ii) take-off (normal and crosswind);
 - (iii) in-flight launch procedures;
 - (iv) descending on tow;
 - (v) sailplane release procedure;
 - (vi) tow rope release procedure;
 - (vii) landing with tow rope connected (if applicable);

- (viii) emergency procedures during tow, including equipment malfunctions;
 - (ix) safety procedures;
 - (x) flight performance of the applicable aircraft type when towing sailplanes;
 - (xi) look-out and collision avoidance;
 - (xii) performance data sailplanes, including:
 - (A) suitable speeds; and
 - (B) stall characteristics in turns;
 - (xiii) effects of wake turbulence and downwash on the towed sailplane's performance, handling characteristics and stall speed; and
 - (xiv) effects of propeller wash in the initial phase of the take-off roll at crosswind.
- (c) Theoretical knowledge: banner towing
- The theoretical knowledge syllabus for banner towing should cover the revision or explanation of:
- (1) regulations about banner towing;
 - (2) equipment for the banner towing activity;
 - (3) ground crew coordination;
 - (4) pre-flight procedures;
 - (5) banner towing techniques, including:
 - (i) take-off launch;
 - (ii) banner pickup manoeuvres;
 - (iii) flying with a banner in tow;
 - (iv) release procedure;
 - (v) landing with a banner in tow (if applicable);
 - (vi) emergency procedures during tow, including equipment malfunctions;
 - (vii) safety procedures;
 - (viii) flight performance of the applicable aircraft type when towing a heavy or light banner; and
 - (ix) prevention of stall during towing operations.
- (d) Flying training: towing of sailplanes
- The exercises of the towing training syllabus for towing sailplanes should be repeated as necessary until the student achieves a safe and competent standard and should comprise at least the following practical training items:
- (1) take-off procedures (normal and crosswind take-offs);
 - (2) 360 ° circles on tow with a bank of 30 ° and more;
 - (3) descending on tow;
 - (4) release procedure of the sailplane;

- (5) landing with the tow rope connected (if applicable);
 - (6) tow rope release procedure in-flight;
 - (7) emergency procedures (simulation); and
 - (8) signals and communication during tow.
- (e) Flying training: banner towing

The exercises of the towing training syllabus for banner towing should be repeated as necessary until the student achieves a safe and competent standard and should comprise at least the following practical training items:

- (1) pickup manoeuvres;
- (2) towing in-flight techniques;
- (3) release procedures;
- (4) flight at critically low air speeds;
- (5) maximum performance manoeuvres;
- (6) emergency manoeuvres to include equipment malfunctions (simulated);
- (7) specific banner towing safety procedures;
- (8) go-around with the banner connected; and
- (9) loss of engine power with the banner attached (simulated).

SFCL.210 TMG night rating

Regulation (EU) 2020/358

- (a) SPL holders with privileges to fly TMGs shall only exercise their TMG privileges in VFR conditions at night if they hold a TMG night rating in accordance with this point.
- (b) Applicants for a TMG night rating shall first complete a training course at an ATO or a DTO. The course shall comprise:
 - (1) theoretical knowledge instruction in flying in visual flight rules (VFR) conditions at night;
 - (2) at least five hours of flight time in TMGs at night, including at least three hours of dual instruction, including at least:
 - (i) One hour of cross-country navigation with at least 1 dual cross-country flight of at least 50 km (27 NM);
 - (ii) Five solo take-offs; and
 - (iii) Five solo full-stop landings.
- (c) To complete the training at night, an SPL holder shall first complete the basic instrument flight training necessary for the issue of a private pilot licence (PPL) in accordance with the provisions of Annex I (Part-FCL) to Regulation (EU) No 1178/2011.
- (d) Applicants for a TMG night rating in accordance with this point shall receive full credit towards the requirements of paragraphs (b) and (c) if they hold a night rating in accordance with point FCL.810 of Annex I (Part-FCL) to Regulation (EU) No 1178/2011 or if they have fulfilled all the requirements for the issue of that rating.

AMC1 SFCL.210 TMG night rating

ED Decision 2020/004/R

TRAINING FOR THE TMG NIGHT RATING

(a) General

The aim of the TMG night instruction is to qualify SPL holders with TMG privileges to operate TMGs in visual meteorological conditions (VMC) at night. The theoretical knowledge and flight instruction should follow the syllabus set out in this AMC.

(b) Theoretical knowledge instruction

The theoretical knowledge syllabus should cover the revision or explanation of:

- (1) night VMC minima;
- (2) rules about airspace control at night and facilities available;
- (3) rules about aerodrome ground, runway, landing site and obstruction lighting;
- (4) aircraft navigation lights and collision avoidance rules;
- (5) physiological aspects of night vision and orientation;
- (6) dangers of disorientation at night and recovery techniques;
- (7) dangers of weather deterioration at night and escape procedures;
- (8) instrument systems (functions and errors);
- (9) instrument lighting and emergency cockpit lighting systems;
- (10) map marking for use under cockpit lighting;
- (11) practical navigation principles;
- (12) radio navigation principles;
- (13) planning and use of safety altitude; and
- (14) danger from icing conditions, avoidance and escape manoeuvres.

(d) Flying training

The exercises of the flight training syllabus should be repeated as necessary until the student achieves a safe and competent standard. Starred items (*) should be completed in simulated instrument meteorological conditions (IMC) and may be completed in daylight.

Exercise 1

- (i) Revise basic manoeuvres when flying by sole reference to instruments*;
- (ii) Explain and demonstrate transition from visual flight to instrument flight*; and
- (iii) Explain and revise recovery from unusual attitudes by sole reference to instruments*.

Exercise 2

Explain and demonstrate the use of radio navigation aids when flying by sole reference to instruments, to include position finding and tracking*.

Exercise 3:

Explain and demonstrate the use of radar assistance*.

Exercise 4

- (i) Explain and demonstrate night take-off techniques;
- (ii) Explain and demonstrate night circuit technique;
- (iii) Explain and demonstrate night approaches with or without visual approach aids; and
- (iv) Practise take-offs, circuits, and approaches and landings.

Exercise 5

Explain and demonstrate night emergency procedures to include:

- (i) simulated engine failure (to be terminated with recovery at a safe altitude);
- (ii) simulated engine failure at various phases of flight;
- (iii) simulated inadvertent entry to IMC (not on base leg or final);
- (iv) internal and external lighting failure; and
- (v) other malfunctions and emergency procedures as required by the AFM.

Exercise 6

Solo night circuits

Exercise 7

- (i) Explain and demonstrate night cross-country techniques; and
- (ii) Practise night cross-country dual and either as student PIC (SPIC) or supervised solo to a satisfactory standard.

SFCL.215 Sailplane cloud flying privileges

Regulation (EU) 2020/358

- (a) SPL holders shall operate a sailplane within cloud only if:
 - (1) any engine is stopped; and
 - (2) they have sailplane cloud flying privileges in accordance with this point.
- (b) The privileges of an SPL shall include sailplane cloud flying privileges if a pilot has completed at least:
 - (1) 30 hours as PIC in sailplanes after the issue of the licence;
 - (2) a training course at an ATO or a DTO, including:
 - (i) theoretical knowledge instruction;
 - (ii) at least two hours of dual flight instruction in sailplanes with any engine stopped, controlling the aircraft solely by reference to instruments. However, a maximum

of 50 % of the dual flight instruction may be completed in TMGs flown with engine power, provided that these training flights are conducted in VMC.

- (c) In order to obtain sailplane cloud flying privileges, an SPL holder who also holds a basic instrument rating (BIR) or an IR(A) in accordance with Annex I (Part-FCL) to Regulation (EU) No 1178/2011 or who has fulfilled all the requirements for the issue of one of these ratings, shall:
- (1) be credited towards the requirement of paragraph (b)(2)(i);
 - (2) by way of derogation from paragraph (b)(2)(ii), complete at least one hour of dual flight instruction in a sailplane, controlling it solely by reference to instruments.
- (d) The completion of the training course as specified in paragraphs (b)(2) or (c)(2), as applicable, shall be entered in the logbook and signed by the head of training of the ATO or the DTO that is responsible for the training.
- (e) SPL holders shall exercise their sailplane cloud flying privileges only if in the last two years before the planned cloud flight they have completed at least one hour of flight time, or five flights, as PIC exercising cloud flying privileges in sailplanes.
- (f) If SPL holders with sailplane cloud flying privileges do not comply with the requirements in paragraph (e) and they wish to resume the exercise of their sailplane cloud flying privileges they shall: (1) pass a proficiency check with an FE(S); or (2) perform the additional flight time or flights required in paragraph (e) with an FI(S).
- (g) SPL holders with sailplane cloud flying privileges who also hold a BIR or an IR(A) in accordance with Annex I (Part-FCL) to Regulation (EU) No 1178/2011 shall be fully credited towards the requirements of paragraph (e).

AMC1 SFCL.215 Sailplane cloud flying privileges

ED Decision 2020/004/R

TRAINING FOR THE SAILPLANE CLOUD FLYING PRIVILEGES

- (a) Theoretical knowledge instruction

The syllabus for theoretical knowledge instruction as per point SFCL.215(b)(2)(i) should cover the revision and/or explanation of:

- (1) Human factors and body limitations
 - (i) basic aviation physiology as regards cloud flying aspects
 - (ii) basic aviation psychology
 - (iii) spatial disorientation
- (2) Principles of flight
 - (i) stability
 - (ii) control
 - (iii) limitations (load factor and manoeuvres)
- (3) Aircraft instrumentation
 - (i) sensors and instruments

-
- (ii) measurement of air data parameters
 - (iii) gyroscopic instruments
 - (4) Navigation
 - (i) use of charts
 - (ii) dead reckoning navigation
 - (iii) use of GNSS
 - (iv) air traffic regulations — airspace structure
 - (v) aeronautical information service
 - (vi) Member State regulations regarding cloud flying
 - (5) Communications
 - (i) VHF communications
 - (ii) relevant weather information terms
 - (6) Hazards and emergency procedures
 - (i) icing
 - (ii) cloud escape procedures
 - (iii) anti-collision instruments/avionics
 - (b) Flight instruction

The exercises of the sailplane cloud flight instruction syllabus should be repeated as necessary until the student achieves a safe and competent standard and should comprise at least the following practical training items, flown solely by reference to instruments:

 - (1) straight flight;
 - (2) turning;
 - (3) achieving and maintaining heading;
 - (4) return to straight flight from steeper angle of bank;
 - (5) position fixing using GNSS and aeronautical charts;
 - (6) position estimating using DR;
 - (7) basic cloud escape manoeuvre/unusual attitude; and
 - (8) advanced cloud escape manoeuvre on nominated heading.
 - (c) When using a TMG with engine power for training exercises with sole reference to instruments, the student should wear an IFR training hood or other suitable vision limiting devices.
 - (d) Course completion standards

The course is successfully completed when the applicant demonstrates, during the course:

 - (1) sufficient knowledge in the items specified in point (a); and
 - (2) a sufficient level of competence to safely perform the exercises specified in point (b) while complying with the following limits:

	Artificial horizon	Turn & slip
Straight flight	Heading $\pm 10^\circ$ IAS ± 10 kt	Heading $\pm 20^\circ$ IAS ± 15 kt
Turning	Angle of bank $\pm 15^\circ$ IAS ± 10 kt	Small deviations in rate of turn with a maximum deviation between $\frac{1}{2}$ & full scale IAS ± 15 kt
Position fixing given: GPS displaying range and bearing to a point	± 2 NM	± 3 NM

SUBPART FI – FLIGHT INSTRUCTORS

SECTION 1 – GENERAL REQUIREMENTS

SFCL.300 Flight instructor certificate

Regulation (EU) 2020/358

(a) General

An instructor shall only carry out flight instruction in a sailplane if he or she:

- (1) holds:
 - (i) an SPL including the privileges, ratings and certificates for which flight instruction is to be provided;
 - (ii) a sailplane flight instructor (FI(S)) certificate appropriate to the instruction carried out, and issued in accordance with this Subpart;
- (2) is entitled to act as PIC in the sailplane during flight instruction.

(b) Instruction provided outside the territory of the Member States

- (1) By way of derogation from paragraph (a)(1), in the case of flight instruction provided during a training course approved in accordance with this Annex (Part-SFCL) outside the territory for which Member States are responsible under the Chicago Convention, the competent authority shall issue a flight instructor certificate to an applicant who holds a sailplane pilot licence that is compliant with Annex 1 to the Chicago Convention, provided that the applicant:
 - (i) holds at least a licence including, where relevant, privileges, ratings or certificates equivalent to those for which he or she is authorised to instruct;
 - (ii) complies with the requirements established in this Subpart for the issue of the FI(S) certificate with the relevant instructional privileges;
 - (iii) demonstrates to the competent authority an adequate level of knowledge of European aviation safety rules to be able to exercise his or her instructional privileges in accordance with this Annex.
- (2) The certificate shall be limited to the provision of flight instruction:
 - (i) outside the territory for which Member States are responsible under the Chicago Convention;
 - (ii) to a student pilot who has sufficient knowledge of the language in which flight instruction is provided.

SECTION 2 — FLIGHT INSTRUCTOR CERTIFICATE FOR SAILPLANES — FI(S)

SFCL.315 FI(S) certificate – Privileges and conditions

Regulation (EU) 2020/358

- (a) Subject to compliance of the applicants with point SFCL.320 and with the following conditions, an FI(S) certificate shall be issued with privileges to conduct flight instruction for:
- (1) an SPL;
 - (2) additional sailplane privileges in accordance with point [SFCL.150\(e\)](#);
 - (3) launching methods in accordance with point [SFCL.155](#), provided that the applicant has completed as PIC:
 - (i) in the case of aerotow launch, at least 30 launches; or
 - (ii) in the case of winch launch, at least 50 launches;
 - (4) additional TMG privileges in accordance with point [SFCL.150\(b\)](#), provided that the applicant has:
 - (i) completed at least 30 hours of flight time as PIC on TMGs;
 - (ii) completed the training as specified in point SFCL.330(b)(2);
 - (iii) demonstrated the ability to instruct on TMGs to an FI(S) who is qualified in accordance with paragraph (7) and nominated by the head of training of the ATO or the DTO;
 - (5) basic aerobatic, advanced aerobatic or sailplane cloud flying privileges or the sailplane towing or the banner towing rating, provided that the applicant:
 - (i) in the case of instruction for basic aerobatic or advanced aerobatic privileges, holds advanced aerobatic privileges in accordance with point [SFCL.200\(c\)](#);
 - (ii) has demonstrated the ability to instruct for the relevant privileges or rating to an FI(S) who is qualified in accordance with paragraph (a)(7) and nominated by the head of training of an ATO or a DTO;
 - (6) TMG flight at night, provided that the applicant:
 - (i) complies with the night experience requirement in point [SFCL.160\(e\)\(2\)](#);
 - (ii) has demonstrated the ability to instruct on TMGs at night to an FI(S) who is qualified in accordance with paragraph (7) and nominated by the head of training of an ATO or a DTO;
 - (7) an FI(S) certificate, provided that the applicant has:
 - (i) completed at least 50 hours or 150 launches of flight instruction in sailplanes;
 - (ii) in accordance with the procedures established for that purpose by the competent authority, demonstrated the ability to instruct for the FI(S) certificate to an FI(S) who is qualified in accordance with this paragraph and nominated by the head of training of an ATO or a DTO.
- (b) The privileges listed in paragraph (a) shall include the privileges to conduct flight instruction for:
- (1) the issue of the relevant licence, privileges, ratings or certificate; and

- (2) the revalidation, renewal or compliance with the relevant recency requirements of this Annex, as applicable.

AMC1 SFCL.315(a)(7)(ii) FI(S) certificate – Privileges and conditions

ED Decision 2020/004/R

DEMONSTRATION OF ABILITY TO INSTRUCT IN FI(S) TRAINING COURSES

The demonstration of the ability to provide instruction during FI(S) training courses, as required in point [SFCL.315\(a\)\(7\)\(ii\)](#), should consist of exercises from the FI(S) training course, as selected by the supervising FI(S), and should, in any case, include all of the following:

- (a) one launch and one landing exercise;
- (b) a selection of air exercises; and
- (c) one emergency exercise.

SFCL.320 FI(S) certificate – Prerequisites and requirements

Regulation (EU) 2020/358

Applicants for an FI(S) certificate shall:

- (a) be at least 18 years of age;
- (b) comply with the requirements of point (a)(1)(i) and paragraph (2) of point [SFCL.300](#);
- (c) have completed 100 hours of flight time and 200 launches as PIC on sailplanes;
- (d) have completed an instructor training course in accordance with point [SFCL.330](#) at an ATO or a DTO; and
- (e) have passed an assessment of competence in accordance with point [SFCL.345](#).

SFCL.325 FI(S) competencies and assessment

Regulation (EU) 2020/358

Applicants for an FI(S) certificate shall be trained to achieve the following competencies:

- (a) prepare resources;
- (b) create a climate conducive to learning;
- (c) present knowledge;
- (d) integrate threat and error management (TEM) and crew resource management (CRM);
- (e) manage time to achieve training objectives;
- (f) facilitate learning;
- (g) assess trainee performance;
- (h) monitor and review progress;
- (i) evaluate training sessions; and
- (j) report outcome.

AMC1 SFCL.325 FI(S) competencies and assessment

ED Decision 2020/004/R

- (a) Training should be both theoretical and practical. Practical elements should include the development of specific instructor skills, particularly in the area of teaching and assessing TEM.
- (b) The training and assessment of instructors should be made against the following performance standards:

Competency	Performance	Knowledge/understanding of
Prepare resources	(a) ensures adequate facilities; (b) prepares briefing material; (c) manages available tools;	(a) objectives; (b) available tools; (c) competency-based training methods;
Create a climate conducive to learning	(a) establishes credentials, role models appropriate behaviour; (b) clarifies roles; (c) states objectives; (d) ascertains and supports student pilot’s needs.	(a) barriers to learning; (b) learning styles.
Present knowledge	(a) communicates clearly; (b) creates and sustains realism; (c) looks for training opportunities.	teaching methods
Integrate Human Factors and TEM	makes Human Factors and TEM links with technical training;	(a) Human Factors and TEM; (b) Causes and countermeasures against undesired aircraft states
Manage time to achieve training objectives	Allocates the appropriate time to achieve competency objective.	syllabus time allocation
Facilitate learning	(a) encourages trainee participation; (b) shows motivating, patient, confident and assertive manner; (c) conducts one-to-one coaching; (d) encourages mutual support.	(a) facilitation; (b) how to give constructive feedback; (c) how to encourage trainees to ask questions and seek advice.
Assesses trainee performance	(a) assesses and encourages trainee self-assessment of performance against competency standards; (b) makes assessment decision and provides clear feedback;	(a) observation techniques; (b) methods for recording observations.
Monitor and review progress	(a) compares individual outcomes to defined objectives; (b) identifies individual differences in learning rates; (c) applies appropriate corrective action.	(a) learning styles; (b) strategies for training adaptation to meet individual needs.
Evaluate training sessions	(a) elicits feedback from student pilots; (b) tracks training session processes against competency criteria; (c) keeps appropriate records.	(a) competency unit and associated elements; (b) performance criteria.
Report outcome	Reports accurately using only observed actions and events.	(a) training phase objectives; (b) individual versus systemic weaknesses.

SFCL.330 FI(S) – Training course

Regulation (EU) 2020/358

- (a) Applicants for an FI(S) certificate shall first pass a specific pre-entry assessment at an ATO or a DTO, which shall take place within the 12 months preceding the start of the training course, to assess their ability to undertake the course.
- (b) The FI(S) training course shall include:
 - (1) on sailplanes, excluding TMGs:
 - (i) the elements specified in point [SFCL.325](#);
 - (ii) 25 hours of teaching and learning;
 - (iii) 30 hours of theoretical knowledge instruction, including progress tests;
 - (iv) at least six hours, of which a maximum of three hours may be completed in TMGs, or 20 launches of flight instruction;
 - (2) additionally, if the privileges of the FI(S) certificate will include the privileges as specified in point [SFCL.315\(a\)\(4\)](#) and (a)(6), at least six hours of dual flight instruction on TMGs.
- (c) Applicants who already hold an instructor certificate in accordance with Annex III (Part-BFCL) to Regulation (EU) 2018/395 or with Annex I (Part-FCL) to Regulation (EU) No 1178/2011 shall be fully credited towards the requirement in paragraph (b)(1)(ii).
- (d) When applying for an FI(S) certificate, a pilot who holds or has held an FI(A), (H) or (As) shall be credited with 18 hours towards the requirements in paragraph (b)(1)(iii).

AMC1 SFCL.330(a) FI(S) – Training course

ED Decision 2020/004/R

PRE-ENTRY ASSESSMENT

The content of the pre-entry assessment should be determined by the ATO or the DTO, taking into account the experience of a particular candidate. It may include interviews and/or an assessment during a simulated training session with the candidate being in the role of the instructor.

AMC1 SFCL.330(b) FI(S) – Training course

ED Decision 2020/004/R

- (a) GENERAL
 - (1) The aim of the FI(S) training course is to train SPL holders to the level of competence defined in point [SFCL.325](#).
 - (2) Throughout the training course, its content and structure should allow the student instructor to develop safety awareness by teaching the knowledge, skills and attitudes relevant to the FI(S) task including at least the following:
 - (i) refresh the technical knowledge of the student instructor;
 - (ii) train the student instructor to teach:
 - (A) the ground subjects and air exercises; and
 - (B) how to access all related sources of information;

- (iii) ensure that the student instructor's flying is of a sufficiently high standard; and
 - (iv) teach the student instructor the principles of basic instruction and to apply them at all training levels.
- (3) With the exception of the section on teaching and learning, all the subject details contained in the ground and flight training syllabus is complementary to the SPL course syllabus.
 - (4) The FI(S) training course should give particular stress to the role of the individual in relation to the importance of human factors in the man-machine interface as well as in the instructor-student interaction during theoretical knowledge instruction. Special attention should be paid to the applicant's maturity and judgement including an understanding of adults, their behavioural attitudes and variable levels of education.
 - (5) During the training course, the applicants should be made aware that their own attitudes are key to flight safety. Identifying and avoiding complacency and improving safety awareness should be a fundamental objective throughout the training course. It is of major importance for the training course to aim at giving applicants the knowledge, skills and attitudes relevant to a flight instructor's task.

(b) CONTENT

The training course consists of two parts:

(1) PART 1 — THEORETICAL KNOWLEDGE INSTRUCTION

Part 1 includes the training specified in points (ii) and (iii) of point [SFCL.330\(b\)\(1\)](#).

The content of the teaching and learning part of the FI(S) course, as established in [AMC1 SFCL.325](#), should be used as guidance to develop the syllabus for the training specified in point [SFCL.325\(b\)\(1\)\(ii\)](#).

(2) PART 2 — FLIGHT INSTRUCTION

Part 2 includes the training specified in point [SFCL.330\(b\)\(1\)\(iv\)](#) and, as applicable, point [SFCL.330\(b\)\(2\)](#).

(i) General

- (A) The air exercises are similar to those of the SPL training course but with additional items designed to cover the needs of a flight instructor.
- (B) The numbering of exercises should be used primarily as an exercise reference list and as a broad instructional sequencing guide. Therefore, the demonstrations and practices need not necessarily be given in the order listed. The actual order and content will depend upon the following interrelated factors:
 - (a) the applicant's progress and ability;
 - (b) the weather conditions affecting the flight;
 - (c) the flight time available;
 - (d) the instructional technique considerations;
 - (e) the local operating environment; and
 - (f) the applicability of the exercises to the aircraft type.

- (C) At the discretion of the instructors, some of the exercises may be combined whereas some other exercises may be done in several flights.
 - (D) It follows that student instructors will eventually be faced with similar inter-related factors. They should be shown and taught how to develop flight lesson plans, taking these factors into account, so as to make the best use of each flight lesson, combining parts of the set exercises as necessary.
- (ii) Briefings and debriefings
- (A) The briefing normally includes a statement of the aim and a brief allusion to principles of flight only if relevant. An explanation is to be given of exactly which air exercises are to be taught by the instructor and practised by the student during the flight. It should include how the flight will be conducted with regard to who is to fly the aircraft and what airmanship, weather and flight safety aspects currently apply. The nature of the lesson will govern the order in which the constituent parts are to be taught.
 - (B) The five basic components of the briefing will be:
 - (a) the aim;
 - (b) the air exercise(s) (what, and how and by whom);
 - (c) flight briefing;
 - (d) check of understanding; and
 - (e) airmanship.
 - (C) After each exercise, the student instructor will debrief the FI(S) in the role of the student pilot. The debriefing is to evaluate:
 - (a) whether the objectives have been fulfilled;
 - (b) whether the errors are minor or major;
 - (c) what can be corrected or improved; and
 - (d) whether the student pilot has reached the required level of competence or the exercise must be done again.

The FI(S) instructor will validate the debriefing.

(iii) Planning of flight lessons

The development of lesson plans is an essential prerequisite of good instruction and the student instructor is to be given supervised practice in the development and practical application of flight lesson plans.

(iv) General considerations

- (A) The student instructor should complete flight training in order to practise the principles of basic instruction at the SPL level. During this training, the student instructor occupies the seat normally occupied by the FI(S).
- (B) The instructor providing this instructor training is normally taking over the role of the student pilot.

- (C) It is to be noted that airmanship is a vital ingredient of all flight operations. Therefore, in the following air exercises, the relevant aspects of airmanship are to be stressed at the appropriate times during each flight.
- (D) The student instructor should learn how to identify common errors and how to correct them properly, which should be emphasised at all times.
- (v) Long briefings and air exercises

Exercise 1: Familiarisation with the sailplane

(a) Objective

To advise the student instructor on how to familiarise the student with the sailplane which will be used for the training and to test the student's position in the sailplane for comfort, visibility, and ability to use all controls and equipment. Furthermore, the student instructor should learn how to identify student errors and how to correct them properly.

(b) Briefing and exercise

The student instructor has to:

- (1) present the type of sailplane which will be used;
- (2) explain the cockpit layout: instruments and equipment;
- (3) explain the flight controls: stick, pedals, airbrakes, flaps (if available), cable release, undercarriage (if available);
- (4) check the position of the student on the seat for comfort, visibility, ability to use all controls;
- (5) explain the use of the harness;
- (6) demonstrate how to adjust the rudder pedal;
- (7) explain the differences when occupying the instructor's position; and
- (8) explain all checklists, drills, and controls.

(c) Debriefing

Exercise 2: Procedure in the event of emergencies

(a) Objective

To advise the student instructor on how to familiarise the student with the use of the parachute and how to explain the bail-out procedure in case of emergency. Furthermore, the student instructor should learn how to identify student errors and how to correct them properly.

(b) Briefing and exercise

The student instructor has to:

- (1) explain how to handle the parachute with care (transport, storage and drying after use);
- (2) demonstrate the adjustment of the parachute harness;

- (3) aid the student to perform the adjustment of the parachute harness;
 - (4) demonstrate the attachment of the static line of the parachute (may be simulated);
 - (5) explain the bail-out procedure (especially from a sailplane in unusual attitude);
 - (6) practise the bail-out procedure;
 - (7) explain the procedure for landing with a parachute in normal conditions and with a strong wind; and
 - (8) demonstrate and practise parachute landing fall drills.
- (c) Debriefing

Exercise 3: Preparation for flight

(a) Objective

To advise the student instructor on how to explain all the operations to be completed prior to flight. Furthermore, the student instructor should learn how to identify student errors and how to correct them properly.

(b) Briefing

The student instructor has to explain:

- (1) the need for a pre-flight briefing;
- (2) the structure and the content of this briefing;
- (3) which documents are required on board;
- (4) which equipment is required for a flight;
- (5) how to handle the sailplane on the ground, how to move it, how to tow it out and how to park it;
- (6) how to do the pre-flight external and internal checks;
- (7) the procedure for verifying in-limits mass and balance; and
- (8) the pre-launch checks (checklist).

(c) Air exercise

The student instructor has to demonstrate:

- (1) the need for a pre-flight briefing;
- (2) that the required documents are on board;
- (3) that the equipment required for the intended flight is on board;
- (4) how to handle the sailplane on the ground, move it to the start position, tow it out and park it;
- (5) how to perform a pre-flight external and internal check;
- (6) how to verify in-limits mass and balance;
- (7) how to adjust harness as well as seat or rudder pedals;

- (8) the pre-launch checks;
 - (9) how to advise the student pilot in performing the pre-flight preparation; and
 - (10) how to analyse and correct pre-flight preparation errors as necessary.
- (d) Debriefing

Exercise 4: Initial experience

- (a) Objective

To advise the student instructor on how to familiarise the student with being in the air, with the area around the airfield, to note the student's reactions in this situation, and to draw the student's attention to safety and look-out procedures. Furthermore, the student instructor should learn how to identify student errors and how to correct them properly.

- (b) Briefing

The student instructor has to explain:

- (1) the area around the airfield;
- (2) the need for looking out; and
- (3) the change of aircraft control.

- (c) Air exercise

The student instructor has to:

- (1) show the noteworthy references on the ground;
- (2) analyse the reactions of the student; and
- (3) check that the student looks out (safety).

- (d) Debriefing

Exercise 5: Primary effects on controls

- (a) Objective

To advise the student instructor on how to:

- (1) demonstrate the primary effects of each control with the help of visual references;
- (2) train the student pilot to recognise when the sailplane is no longer in a normal attitude along one of the axes and to return to the normal attitude;
- (3) train continuous and efficient look-out during these exercises; and
- (4) analyse and correct errors and student pilot mistakes as necessary.

- (b) Briefing

The student instructor has to explain:

- (1) the definitions of the axes of a sailplane;
 - (2) the look-out procedures;
 - (3) the visual references along each axis;
 - (4) the primary effects of controls when laterally level;
 - (5) the relationship between attitude and speed;
 - (6) the use of flaps; and
 - (7) the use of airbrakes.
- (c) Air exercise
- The student instructor has to demonstrate:
- (1) the visual references in flight;
 - (2) the primary effect of the elevator;
 - (3) the relationship between attitude and speed (inertia);
 - (4) the primary effect of rudder on the rotation of the sailplane around the vertical axis;
 - (5) the primary effect of ailerons on banking;
 - (6) the effect of airbrakes (including changes in pitch when airbrakes are extended or retracted);
 - (7) the effects of flaps (provided the sailplane has flaps);
 - (8) the look-out procedures during all the exercises;
 - (9) how to advise the student pilot to recognise the primary effects of each control; and
 - (10) how to analyse and correct errors as necessary.
- (d) Debriefing

Exercise 6: Co-ordinated rolling to and from moderate angles of bank

- (a) Objective
- To advise the student instructor on secondary effects of controls and on how to teach the student to coordinate ailerons and rudder in order to compensate for the adverse yaw effect. Furthermore, the student instructor should learn how to identify student errors and how to correct them properly.
- (b) Briefing
- The student instructor has to explain:
- (1) the secondary effects of controls;
 - (2) the adverse yaw effect;
 - (3) how to compensate for the adverse yaw; and
 - (4) the further effect of the rudder (roll).

(c) Air exercise

The student instructor has to demonstrate:

- (1) the adverse yaw effect with a reference on ground;
- (2) the further effect of the rudder (roll);
- (3) the coordination of ruder and aileron controls to compensate for the adverse yaw effects;
- (4) rolling to and from moderate angles of bank (20 to 30 °) and returning to the straight flight;
- (5) how to advise the student pilot to coordinate ailerons and rudder; and
- (6) how to analyse and correct errors as necessary.

(d) Debriefing

Exercise 7: Straight flight

(a) Objective

To advise the student instructor on how to train the student to maintain straight flight with a constant heading without slipping and skidding. Furthermore, the student instructor should learn how to identify student errors and how to correct them properly.

(b) Briefing

The student instructor has to explain:

- (1) how to maintain straight flight;
- (2) the different air speed limitations;
- (3) the pitch stability of the sailplane; and
- (4) the effect of trimming.

(c) Air exercise

The instructor student has to demonstrate:

- (1) maintaining straight flight;
- (2) inherent pitch stability;
- (3) the control of the sailplane in pitch, including use of trim with visual references and speed;
- (4) how to perform the instrument monitoring;
- (5) the control of level attitude with visual references;
- (6) the control of the heading with a visual reference on the ground;
- (7) the look-out procedures during all the exercises;
- (8) how to advise the student pilot to maintain straight flight; and
- (9) how to analyse and correct errors as necessary.

- (d) Debriefing

Exercise 8: Turning

- (a) Objective

To advise the student instructor on how to teach students to fly turns and circles with a moderate constant bank of about 30 ° with constant attitude (speed) and coordinated flight. Furthermore, the student instructor should learn how to identify student errors and how to correct them properly.

- (b) Briefing

The student instructor has to explain:

- (1) the forces on the sailplane during a turn;
- (2) the need to look out before turning;
- (3) the sequences of a turn (entry, stabilising and exiting);
- (4) the common faults during a turn;
- (5) how to turn on to selected headings, use of compass; and
- (6) the use of instruments (ball indicator or slip string) for precision.

- (c) Air exercise

The student instructor has to demonstrate:

- (1) the look-out procedure before turning;
- (2) entering a turn (correction of adverse yaw);
- (3) the stabilisation of a turn (keeping the attitude and compensating the induced roll);
- (4) the exit from a turn;
- (5) the most common faults in a turn;
- (6) turns on to selected headings (use landmarks as reference);
- (7) the use of instruments (ball indicator or slip string) for precision;
- (8) how to advise the student pilot to fly a turn or circle with a moderate bank; and
- (9) how to analyse and correct errors as necessary.

- (d) Debriefing

Exercise 9a: Slow flight

- (a) Objective

To advise the student instructor on how to improve the student's ability to recognise inadvertent flight at critically low speeds (high angle of attack) and to provide practice in maintaining the sailplane in balance while returning to normal attitude (speed). Furthermore, the student instructor should learn how to identify student errors and how to correct them properly.

(b) Briefing

The student instructor has to explain:

- (1) the characteristics of slow flight; and
- (2) the risks of stalling.

(c) Air exercise

The student instructor has to check that the airspace below the sailplane is free of other aircraft before starting the exercise.

The student instructor has to demonstrate:

- (1) a controlled flight down to critically high angle of attack (slow air speed), and draw the attention of the student to the nose up attitude, reduction of noise, reduction of speed;
- (2) a return to the normal attitude (speed);
- (3) how to advise the student pilot to recognise inadvertent flight at critically low speeds;
- (4) how to provide practice in maintaining the sailplane in balance while returning to normal attitude; and
- (5) how to analyse and correct errors as necessary.

(d) Debriefing

Exercise 9b: Stalling

(a) Objective

To advise the student Instructor on how to improve the student's ability to recognise a stall and to recover from it. This includes stall from a level flight and stalls when a wing drops. Furthermore, the student instructor should learn how to identify student errors and how to correct them properly.

(b) Briefing

The student instructor has to explain:

- (1) the mechanism of a stall;
- (2) the effectiveness of the controls at the stall;
- (3) pre-stall symptoms, recognition and recovery;
- (4) factors affecting the stall (importance of the angle of attack and high speed stall);
- (5) effect of flaps if any on the sailplane;
- (6) the effects of unbalance at the stall safety checks;
- (7) stall symptoms, recognition and recovery;
- (8) recovery when a wing drops; and
- (9) approach to stall in the approach and in the landing configurations;

(10) recognition and recovery from accelerated stalls.

(c) Air exercise

The student instructor has to check that the airspace below the sailplane is free of other aircraft or traffic before starting the exercise.

The student instructor has to demonstrate:

- (1) stall from straight flight;
- (2) pre-stall symptoms, recognition and recovery;
- (3) stall symptoms, recognition and recovery;
- (4) recovery when a wing drops;
- (5) approach to stall in the approach and in the landing configurations;
- (6) recognition and recovery from accelerated stalls;
- (7) stalling and recovery at the incipient stage with 'instructor induced' distractions;
- (8) how to improve the student pilot's ability to recognise a stall and to recover from it; and
- (9) how to analyse and correct errors as necessary.

Note: Consideration is to be given to manoeuvre limitations and references to the flight manual or equivalent document (for example, owner's manual or pilot's operating handbook) in relation to mass and balance limitations. The safety checks should take into account the minimum safe altitude for initiating such exercises in order to ensure an adequate margin of safety for the recovery. If specific procedures for stalling or spinning exercises and for the recovery techniques are provided by the flight manual or equivalent document (for example, owner's manual or pilot's operating handbook), they have to be taken into consideration. These factors are also covered in the next exercise.

(d) Debriefing

Exercise 10a: Spin recognition and avoidance

(a) Objective

To advise the student instructor on how to improve the student's ability to recognise a spin at the incipient stage and to recover from it. Furthermore, the student instructor should learn how to identify student errors and how to correct them properly.

(b) Briefing

The student instructor has to explain:

- (1) why a sailplane spins;
- (2) how to recognise the symptoms of a spin (not to be confused with spiral dive);

- (3) what are the parameters influencing the spin; and
 - (4) how to recover from a spin.
- (c) Air exercise
- The student instructor has to check that the airspace below the sailplane is free of other aircraft or traffic before starting the exercise.
- The student instructor has to:
- (1) demonstrate stalling and recovery at the incipient spin stage (stall with excessive wing drop, about 45 °);
 - (2) make sure that the student recognises the spin entry;
 - (3) make sure that the student pilot is able to recover from the spin;
 - (4) check whether the student still reacts properly if the instructor induces distractions during the spin entry;
 - (5) demonstrate how to analyse and correct errors as necessary.
- Note: Consideration of manoeuvre limitations and the need to refer to the sailplane manual and mass and balance calculations.
- (d) Debriefing

Exercise 10b: Developed spins: entry and recovery

- (a) Objective
- To advise the student instructor on how to recognise a developed spin and to recover from it. Furthermore, the student instructor should learn how to identify student errors and how to correct them properly.
- (b) Briefing
- The student instructor has to explain:
- (1) the spin entry;
 - (2) the symptoms of a real spin and the recognition and identification of spin direction;
 - (3) the spin recovery;
 - (4) use of controls;
 - (5) effects of flaps (flap restriction applicable to type);
 - (6) the effect of the CG upon spinning characteristics;
 - (7) the spinning from various flight attitudes;
 - (8) the sailplane limitations;
 - (9) safety checks; and
 - (10) common errors during recovery.
- (c) Air exercise

The student instructor has to check that the airspace below the sailplane is free of other aircraft or traffic before starting the exercise.

The student instructor has to demonstrate:

- (1) safety checks;
 - (2) the spin entry;
 - (3) the recognition and identification of the spin direction;
 - (4) the spin recovery (reference to flight manual);
 - (5) the use of controls;
 - (6) the effects of flaps (restrictions applicable to sailplane type);
 - (7) spinning and recovery from various flight attitudes;
 - (8) how to improve the student pilot's ability to recognise a spin and how to recover from it; and
 - (9) how to analyse and correct errors as necessary.
- (d) Debriefing

Note (exercises 11a to 11c): The student instructor has to teach at least one of the following launch methods: winch launch, aero tow, and self-launch. At least three launch failure exercises should be completed. Furthermore, the student instructor should learn how to identify student errors and how to correct them properly.

Exercise 11a: Winch launch

(a) Objective

To advise the student instructor on how to teach winch launches and on how to make sure that their student will manage an aborted launch. Furthermore, the student instructor should learn how to identify student errors and how to correct them properly.

(b) Briefing

The student instructor has to explain:

- (1) the signals or communication before and during launch;
- (2) the use of the launching equipment;
- (3) the pre-take-off checks;
- (4) the procedure for into wind take-off;
- (5) the procedure for crosswind take-off;
- (6) the safe and adequate profile of winch launch and limitations; and
- (7) the launch failure procedures.

(c) Air exercise

The student instructor has to demonstrate:

- (1) the use of the launching equipment;
 - (2) the pre-take-off checks;
 - (3) the into wind take-off;
 - (4) the crosswind take-off;
 - (5) the safe and adequate profile of winch launch and limitations;
 - (6) the procedure in case of cable break or aborted launch, launch failure procedures simulated during the winch launch;
 - (7) how to teach the student pilot to perform safe winch launches;
 - (8) how to teach the student pilot to manage an aborted launch (different altitudes and speeds); and
 - (9) how to analyse and correct errors as necessary.
- (d) Debriefing

Exercise 11b: Aero tow

(a) Objective

To advise the student instructor on how to teach aero towing and on how to make sure that their student will manage an aborted launch. Furthermore, the student instructor should learn how to identify student errors and how to correct them properly.

(b) Briefing

The student instructor has to explain:

- (1) the signals or communication before and during launch;
- (2) the use of the launch equipment;
- (3) the pre-take-off checks;
- (4) the procedure for into wind take-off;
- (5) the procedure for crosswind take-off;
- (6) the procedure on tow: straight flight, turning and slip stream;
- (7) the recovery from out-of-position on tow;
- (8) the procedures in case of launch failure and abandonment;
- (9) the descending procedure on tow (towing aircraft and sailplane); and
- (10) the reasons for launch failures and abandonment or procedures.

(c) Air exercise

The student instructor has to demonstrate:

- (1) the signals before and during launch;
- (2) the use of the launch equipment;
- (3) the pre-take-off checks;

- (4) the procedure for into wind take-off;
 - (5) the procedure for a crosswind take-off;
 - (6) the procedures on tow: straight flight, turning and slip stream;
 - (7) the recovery from out-of-position on tow;
 - (8) the procedure in case of launch failure and abandonment simulated by releasing the cable at a suitable height, with and without response to a signal from the tow plane.;
 - (9) the descending procedure on tow;
 - (10) how to teach the student pilot to perform safe aero tow launches;
 - (11) how to teach the student pilot to manage an aborted launch; and
 - (12) how to analyse and correct errors as necessary.
- (d) Debriefing

Exercise 11c: Self launch

(a) Objective

To advise the student instructor on how to teach launching with a self-launching sailplane and on how to make sure that the student will manage an aborted launch. Furthermore, the student instructor should learn how to identify student errors and how to correct them properly.

(b) Briefing

The student instructor has to explain:

- (1) the engine extending and retraction procedures;
- (2) the engine starting and safety precautions;
- (3) the pre-take-off checks;
- (4) the noise abatement procedures;
- (5) the checks during and after take-off;
- (6) the into wind take-off;
- (7) the crosswind take-off;
- (8) the procedure in case of power failure;
- (9) the procedure in case of abandoned take-off;
- (10) the maximum performance (short field and obstacle clearance) take-off; and
- (11) the short take-off and soft field procedure or techniques and performance calculations.

(c) Air exercise

The student instructor has to demonstrate:

- (1) the engine extending and retraction procedures;

- (2) the engine starting and safety precautions;
 - (3) the pre-take-off checks;
 - (4) the noise abatement procedures;
 - (5) the checks during and after take-off;
 - (6) the into wind take-off;
 - (7) the crosswind take-off;
 - (8) the power failures and procedures;
 - (9) the procedure in case of abandoned take-off;
 - (10) the maximum performance (short field and obstacle clearance) take-off;
 - (11) the short take-off and soft field procedure or techniques and performance calculations;
 - (12) how to teach the student pilot to perform safe self-launches;
 - (13) how to teach the student pilot to manage an aborted launch (different altitudes); and
 - (14) how to analyse and correct errors as necessary.
- (d) Debriefing

Exercise 12: Circuit approach and landing

- (a) Objective

To advise the student instructor on how to teach the student to fly a safe circuit approach and to land the sailplane. Furthermore, the student instructor should learn how to identify student errors and how to correct them properly.

- (b) Briefing

The student instructor has to explain:

- (1) the procedures for rejoining the circuit;
- (2) the procedures for collision avoidance and the look-out techniques;
- (3) the pre-landing check;
- (4) the normal circuit procedures, downwind, base leg;
- (5) the effect of wind on approach and touchdown speeds ;
- (6) the visualisation of a reference point;
- (7) the approach control and use of airbrakes;
- (8) the use of flaps (if applicable); and
- (9) the procedures for normal and crosswind approach and landing.

(c) Air exercise

The student instructor has to demonstrate:

- (1) the procedures for rejoining the circuit;
- (2) the procedures for collision avoidance and the look-out techniques;
- (3) the pre-landing check;
- (4) the standard circuit and contingency planning (for example, running out of height);
- (5) the effect of wind on approach and touchdown speeds;
- (6) the visualisation of an aiming point;
- (7) the approach control and use of airbrakes;
- (8) the use of flaps (if applicable);
- (9) the procedures for normal and crosswind approaches and landings;
- (10) how to teach the student pilot to fly a safe circuit approach;
- (11) how to improve the student pilot's ability to perform a safe landing; and
- (12) how to analyse and correct errors as necessary.

(d) Debriefing

Exercise 13: First solo flight

(a) Objective

To advise the student instructor on how to prepare their students for the first solo flight.

(b) Briefing

The student instructor has to explain:

- (1) the limitations of the flight (awareness of local area and restrictions);
- (2) the use of required equipment; and
- (3) the effect of the CG on the longitudinal stability of the sailplane.

(c) Air exercise

The student instructor has to:

- (1) check with another or more senior instructor if the student can fly solo;
- (2) monitor the flight; and
- (3) debrief the flight with the student.

(d) Debriefing

Exercise 14: Advanced turning

(a) Objective

To advise the student instructor on how to teach steep turns or circles (45 ° banking) at constant attitude (speed) and with the yaw string centred. Furthermore, the student instructor should learn how to identify student errors and how to correct them properly.

(b) Briefing

The student instructor has to explain:

- (1) the relationship between banking and speed;
- (2) how to master steep turns or circles;
- (3) the unusual attitudes which can occur (stalling or spinning and spiral dive); and
- (4) how to recover from these unusual attitudes.

(c) Air exercise

The student has to demonstrate:

- (1) steep turns (45 °) at constant speed and with the yaw string centred;
- (2) common errors (slipping and skidding);
- (3) unusual attitudes and how to recover from them;
- (4) how to teach the student pilot to fly steep turns or circles; and
- (5) how to analyse and correct errors as necessary.

(d) Debriefing

Note (exercises 15a to 15c): If the weather conditions during the instructor training course do not allow the practical training of soaring techniques, all items of the air exercises have to be discussed and explained during a long briefing exercise only.

Exercise 15a: Soaring techniques: thermalling

(a) Objective

To advise the student instructor on how to teach the student to recognise and detect thermals, on how to join a thermal and on how to look out, in order to avoid mid-air collisions. Furthermore, the student instructor should learn how to identify student errors and how to correct them properly.

(b) Briefing

The student instructor has to explain:

- (1) the look-out procedures;
- (2) the detection and recognition of thermals;
- (3) the use of audio soaring instruments;

- (4) the procedure for joining a thermal and giving way;
 - (5) how to fly in close proximity to other sailplanes;
 - (6) how to centre in thermals; and
 - (7) how to leave thermals.
- (c) Air exercise
- The student instructor has to demonstrate:
- (1) the look-out procedures;
 - (2) the detection and recognition of thermals;
 - (3) the use of audio soaring instruments;
 - (4) the procedure for joining a thermal and giving way;
 - (5) the procedure for flying in close proximity to other sailplanes;
 - (6) the centring in thermals;
 - (7) the procedure for leaving thermals;
 - (8) how to improve the student pilot's ability to recognise and detect thermals;
 - (9) how to improve the student pilot's ability to join a thermal and how to look out; and
 - (10) how to analyse and correct errors as necessary.
- (d) Debriefing

Exercise 15b: Soaring techniques: ridge flying

- (a) Objective
- To advise the student instructor on how to teach the student to fly safely on ridges, to control their speed, and to apply the rules in order to avoid mid-air collisions. Furthermore, the student instructor should learn how to identify student errors and how to correct them properly.
- (b) Briefing
- The student instructor has to explain:
- (1) the look-out procedures;
 - (2) the ridge flying rules;
 - (3) the recognition of safe and adequate flight path; and
 - (4) speed control.
- (c) Air exercise (if applicable during training and, if possible, at training site)
- The student instructor has to demonstrate:
- (1) the look-out procedures;
 - (2) the practical application of ridge flying rules;

- (3) the recognition of safe and adequate flight path;
 - (4) speed control;
 - (5) how to teach the student pilot to fly safely on ridges; and
 - (6) how to analyse and correct errors as necessary.
- (d) Debriefing

Exercise 15c: Soaring techniques: wave flying

- (a) Objective

To advise the student instructor on how to introduce students to wave flying and to teach them to fly safely at high altitude. Furthermore, the student instructor should learn how to identify student errors and how to correct them properly.

- (b) Briefing

The student instructor has to explain:

- (1) the look-out procedures;
- (2) the techniques to be used to access a wave;
- (3) the speed limitations with increasing height; and
- (4) the risks of hypoxia and the use of oxygen.

- (c) Air exercise (if applicable during training and if possible at training site)

The student instructor has to demonstrate:

- (1) the look-out procedures;
- (2) the wave access techniques;
- (3) the speed limitations with increasing height;
- (4) the use of oxygen (if available);
- (5) how to improve the student pilot's ability to recognise and detect waves;
- (6) how to teach the student pilot to fly safely in a wave; and
- (7) how to analyse and correct errors as necessary.

- (d) Debriefing

Exercise 16: Out-landings

Note: If the weather conditions during the instructor training do not allow the practical training of out-landing procedures (a TMG may be used), all items of the air exercise have to be discussed and explained during a long briefing exercise only. Instructors may only teach the safe out-landing exercise after they have demonstrated the practical ability to do so.

(a) Objective

To advise the student instructor on how to teach students to select an out-landing field, to fly the circuit and how to master the unusual landing situation. Furthermore, the student instructor should learn how to identify student errors and how to correct them properly.

(b) Briefing

The student instructor has to explain:

- (1) the gliding range at max glide ratio;
- (2) the engine re-start procedures (only for self-launching and self-sustaining sailplanes);
- (3) the selection of a landing area;
- (4) the circuit judgement and key positions;
- (5) the circuit and approach procedures; and
- (6) the actions to be performed after landing.

(c) Air exercise

The student instructor has to demonstrate:

- (1) precision landings on the airfield;
- (2) the gliding range;
- (3) the procedures for joining, arrival and circuit at a remote aerodrome;
- (4) the selection of an out-landing area;
- (5) the procedures for circuit and approach on an out-landing field;
- (6) the actions to be performed after landing.

The student instructor also has to be trained on:

- (7) how to advise the student pilot to do perform a safe out-landing;
- (8) how to master an unusual landing situation; and
- (9) how to analyse and correct errors as necessary.

(d) Debriefing

Note (Exercises 17a to 17c): If the weather conditions during the instructor training do not allow a cross-country training flight, the items of the air exercise have to be discussed and explained during a long briefing exercise only.

Exercise 17a: Flight planning

(a) Objective

To advise the student instructor on how to plan and prepare a cross-country flight.

(b) Briefing

The student instructor has to explain:

- (1) the weather forecast and current situation;
- (2) the selection of the amount of water to be carried as a function of the weather forecast;
- (3) the method for selecting a task, taking into account the average speed to be expected;
- (4) the map selection and preparation;
- (5) the NOTAMs and airspace considerations;
- (6) the radio frequencies (if applicable);
- (7) the pre-flight administrative procedures;
- (8) the procedure for filing an ICAO flight plan where required; and
- (9) alternate aerodromes and landing areas.

(c) Debriefing

Exercise 17b: In-flight navigation

(a) Objective

To advise the student instructor on how to teach performing a cross-country flight.

(b) Briefing

The student instructor has to explain:

- (1) how to maintain track and re-route if necessary;
- (2) the altimeter settings;
- (3) the use of radio and phraseology;
- (4) the in-flight planning;
- (5) the procedures for transiting regulated airspace or ATC liaison where required;
- (6) the procedure in case of uncertainty of position; and
- (7) the procedure in case of becoming lost;

(c) Air exercise

The student instructor has to demonstrate:

- (1) maintaining track and re-routing if necessary;
- (2) altimeter settings;
- (3) the use of radio and phraseology;
- (4) in-flight planning;

- (5) procedures for transiting regulated airspace or ATC liaison where required;
 - (6) uncertainty of position procedure;
 - (7) lost procedure;
 - (8) use of additional equipment where required;
 - (9) joining, arrival and circuit procedures at remote aerodrome;
 - (10) how to teach the student pilot to perform a cross-country flight; and
 - (11) how to analyse and correct errors as necessary.
- (d) Debriefing

Exercise 17c: Cross-country soaring techniques

- (a) Objective
- To advise the student instructor on the techniques for an efficient cross-country flight.
- (b) Briefing
- The student instructor has to explain:
- (1) the speed to fly at maximal glide ratio;
 - (2) the speed to fly to maximise the cruise speed (MacCready theory);
 - (3) how to select the optimal track (efficient use of cloud streets, etc.);
 - (4) how to calculate the final glide; and
 - (5) how to perform a safe out-landing.
- (c) Air exercise
- The student instructor has to demonstrate:
- (1) a cross-country flight;
 - (2) the selection of the optimal track (efficient use of cloud streets, etc.);
 - (3) methods for determining optimal speed to fly;
 - (4) use of final glide computers;
 - (5) how to reduce risk and to react to potential dangers;
 - (6) how to plan and perform an out-landing;
 - (7) how to teach the student pilot techniques for an efficient cross-country flight; and
 - (8) how to analyse and correct errors as necessary.
- (d) Debriefing

- (vi) Additional training elements for TMG instructional privileges as per point [SFCL.330\(b\)\(2\)](#)

Additional training for TMG instructional privileges should include, following the principles of briefing, exercise and debriefing as established in points (b)(2)(ii) and (b)(2)(v), the training syllabus set out in point (c) of [AMC1 SFCL.150\(b\)](#).

SFCL.345 FI(S) – Assessment of competence

Regulation (EU) 2020/358

- (a) Applicants for the issue of an FI(S) certificate shall pass an assessment of competence to demonstrate to an examiner qualified in accordance with point SFCL.415(c) the ability to instruct a student pilot to the level required for the issue of an SPL.
- (b) The assessment shall include:
- (1) the demonstration of the competencies described in point [SFCL.325](#), during pre-flight, post-flight and theoretical knowledge instruction;
 - (2) oral theoretical examinations on the ground, pre-flight and post-flight briefings, and in-flight demonstrations in sailplanes;
 - (3) exercises adequate to evaluate the instructor's competencies.
- (c) The assessment of competence for the initial issue of an FI(S) certificate shall be conducted in sailplanes, excluding TMGs.

AMC1 SFCL.345 FI(S) – Assessment of competence

ED Decision 2020/004/R

GENERAL

- (a) The format and application form for the assessment of competence are determined by the competent authority.
- (b) The sailplane that is used for the assessment should meet the requirements for training aircraft.
- (c) The FE(S) acts as the PIC.
- (d) During the skill test the applicant occupies the seat normally occupied by the instructor. The FE(S) functions as the 'student'. The applicant is required to explain the relevant exercises and to demonstrate their conduct to the 'student', where appropriate. Thereafter, the 'student' executes the same manoeuvres which can include typical mistakes of inexperienced students. The applicant is expected to correct mistakes orally or, if necessary, by intervening physically.
- (e) All relevant exercises should be completed within a period of 6 months. However, all exercises should, where possible, be completed on the same day. In principle, failure in any exercise requires a retest covering all exercises, with the exception of those that may be retaken separately. The FE(S) may terminate the assessment at any stage if they consider that a retest is required.

AMC2 SFCL.345 FI(S) – Assessment of competence

ED Decision 2020/004/R

CONTENT OF THE ASSESSMENT OF COMPETENCE

- (a) The content of the assessment of competence for the FI(S) should be the following:

SECTION 1: ORAL THEORETICAL KNOWLEDGE EXAMINATION	
1.1	Air law
1.2	Aircraft general knowledge
1.3	Flight performance and planning
1.4	Human performance and limitations
1.5	Meteorology
1.6	Navigation
1.7	Operational procedures
1.8	Principles of flight
1.9	Training administration

SECTION 2: PRE-FLIGHT BRIEFING	
2.1	Visual presentation
2.3	Technical accuracy
2.4	Clarity of explanation
2.5	Clarity of speech
2.6	Instructional technique
2.7	Use of models and aids
2.8	Student participation

SECTION 3: FLIGHT	
3.1	Arrangement of demonstration
3.2	Synchronisation of speech with demonstration
3.3	Correction of faults
3.4	Aircraft handling
3.5	Instructional technique
3.6	General airmanship and safety
3.7	Positioning and use of airspace

SECTION 4: POST-FLIGHT DE-BRIEFING	
4.1	Visual presentation
4.2	Technical accuracy
4.3	Clarity of explanation
4.4	Clarity of speech
4.5	Instructional technique
4.6	Use of models and aids
4.7	Student participation

- (b) Section 1, the oral theoretical knowledge examination part of the assessment of competence, is divided into two parts:

- (1) The applicant is required to give a lecture under test conditions to other ‘student(s)’, one of whom will be the FE(S). The test lecture is to be selected from items of Section 1. The amount of time for preparation of the test lecture is agreed upon beforehand with the FE(S). Appropriate literature may be used by the applicant. The test lecture should not exceed 45 minutes.
- (2) The applicant is tested orally by an FE(S) for knowledge of items of Section 1 and the core instructor competencies (teaching and learning content given in the FI(S) training course).
- (c) Sections 2, 3 and 4 comprise exercises to demonstrate the ability to be an FI(S) (for example, instructor demonstration exercises) chosen by the FE(S) from the flight syllabus of the FI(S) training course. The applicant is required to demonstrate FI(S) abilities, including briefing, flight instruction and de-briefing.

AMC3 SFCL.345 FI(S) – Assessment of competence

ED Decision 2020/004/R

APPLICATION AND REPORT FORM FOR THE FI(S) ASSESSMENT OF COMPETENCE

APPLICATION AND REPORT FORM FOR THE FI(S) ASSESSMENT OF COMPETENCE		
I hereby apply for the issue of a flight instructor certificate for sailplanes (FI(S)) in accordance with Annex III (Part-SFCL) to Regulation (EU) 2018/1976.		
1 Applicant’s personal particulars		
Applicant’s last name(s):		First name(s):
Date of birth:	Telephone:	Email:
Address:		Country:
Date:		Signature of the applicant:
2 Licence details		
Licence number (SPL):		
Additional privileges: <i>(tick as applicable)</i>	<input type="checkbox"/> TMG extension <input type="checkbox"/> TMG night rating <input type="checkbox"/> Advanced aerobatic privileges	<input type="checkbox"/> Sailplane cloud flying privileges <input type="checkbox"/> Sailplane towing rating <input type="checkbox"/> Banner towing rating
Launching methods: <i>(tick as applicable)</i>	<input type="checkbox"/> Aero tow launch <input type="checkbox"/> Winch launch	<input type="checkbox"/> Bungee launch <input type="checkbox"/> Self-launch
3 Pre-course flying experience		
	Sailplanes	TMG
PIC hours:		
Total hours:		
Number of launches / take-offs:	Aero tow launch:	
	Winch launch:	
4 Pre-entry assessment		
I recommend for the FI(S) course.		
Name of ATO/DTO:		Date of pre-entry assessment:
Name (capital letters) of HT of the ATO/DTO:		

Name (capital letters), licence number and signature of the FI(S) conducting the flight assessment (if applicable):			
5 Declaration by the ATO/DTO			
I certify that has satisfactorily completed an approved course of training for the FI(S) certificate in accordance with the relevant syllabus.			
Flying hours during the course:		Take-offs during the course:	
Sailplanes, powered sailplanes or TMGs used:			
Name(s) of HT:			
Signature:			
Name of ATO/DTO:			
FROM HERE TO BE COMPLETED BY THE EXAMINER			
6 Result of the assessment of competence			
Oral theoretical knowledge examination:	<input type="checkbox"/> Passed <input type="checkbox"/> Partially passed <input type="checkbox"/> Failed	Practical part:	<input type="checkbox"/> Passed <input type="checkbox"/> Partially passed <input type="checkbox"/> Failed
Reasons and details in case of fail or partial pass/other remarks as necessary:			
In case of fail: (tick as applicable)	<input type="checkbox"/> I recommend further ground training before retest. <input type="checkbox"/> I recommend further flight training with an FI(S) before retest. <input type="checkbox"/> I do not consider further flight or theoretical instruction necessary before retest.		
I, the undersigning examiner:			
<ul style="list-style-type: none"> — have received information from the applicant regarding their experience and instruction, and found that experience and instruction comply with the applicable requirements of Annex III (Part-SFCL) to Regulation (EU) 2018/1976; — confirm that all the required manoeuvres and exercises have been completed, unless specified otherwise above in the case of fail; and — where applicable, have reviewed and applied the national procedures and requirements of the applicant's competent authority which is different from the competent authority that issued my examiner certificate. 			
Examiner's certificate number:		Examiner's SPL number:	
Examiner's name (capital letters):		Date and examiner's signature:	
7 Attachments			
Detailed report as per AMC2 SFCL.345 to be attached			
Copy of the FE(S) certificate (in cases where the competent authority of the applicant is different from the competent authority of the examiner)			

SFCL.350 FI(S) – Restricted privileges

Regulation (EU) 2020/358

- (a) An FI(S) shall have his or her privileges limited to conducting flight instruction under the supervision of an unrestricted FI(S) nominated by the ATO or the DTO for this purpose, in the following cases:
- (1) for the issue of an SPL;
 - (2) for extending the privileges of an SPL to additional sailplane or TMG privileges in accordance with point [SFCL.150](#);
 - (3) for extending the privileges of an SPL to additional launching methods in accordance with point [SFCL.155](#); and
 - (4) for basic aerobatic, advanced aerobatic or sailplane cloud flying privileges or for the sailplane towing or banner towing rating.
- (b) Whilst conducting training under supervision, in accordance with paragraph (a), the FI(S) shall not have the privilege to authorise a student pilot to conduct his or her first solo flight or first solo cross-country flight.
- (c) The limitations in (a) and (b) shall be removed from the FI(S) certificate after the FI(S) has completed at least 15 hours or 50 launches of flight instruction covering all phases of a sailplane flight. In the case of a restricted FI(S) who complied with point [SFCL.330\(b\)\(2\)](#), 5 out of those 15 hours may be completed in TMGs, and 15 out of those 50 launches may be replaced by take-offs and landings in TMGs.

SFCL.360 FI(S) certificate – Recency requirements

Regulation (EU) 2020/358

- (a) An FI(S) certificate holder shall only exercise the privileges of his or her certificate if before the planned exercise of those privileges he or she has:
- (1) within the last three years, completed:
 - (i) instructor refresher training at an ATO, a DTO, or a competent authority during which the holder shall receive theoretical knowledge instruction for refreshing and updating the knowledge relevant for sailplane instructors; and
 - (ii) when providing flight instruction as FI(S), at least:
 - (A) 30 hours; or
 - (B) 60 launches or take-offs and landings; and
 - (2) within the last nine years and in accordance with the procedures established for that purpose by the competent authority, demonstrated the ability to instruct on sailplanes to an FI(S) who is qualified in accordance with point [SFCL.315\(a\)\(7\)](#) and nominated by the head of training of an ATO or a DTO.
- (b) The hours flown as an FE(S) during skill tests, proficiency checks and assessments of competence shall be fully credited towards the requirement in paragraph (a)(1)(ii).
- (c) If the FI(S) certificate holder has failed to complete the instruction flight under supervision to the satisfaction of the FI(S) in accordance with paragraph (a)(2), he or she shall not exercise the

privileges of the FI(S) certificate until he or she has successfully completed an assessment of competence in accordance with point [SFCL.345](#).

- (d) To resume the exercise of the privileges of the FI(S) certificate, an FI(S) certificate holder who does not comply with all the requirements in paragraph (a) shall comply with the requirements of paragraph (a)(1)(i) and of point [SFCL.345](#).

AMC1 SFCL.360(a)(1)(i) FI(S) certificate – Recency requirements

ED Decision 2020/004/R

INSTRUCTOR REFRESHER TRAINING

- (a) The FI(S) refresher training should be held in the form of a seminar. Such seminars made available in Member States should have due regard to geographical location, number of participants, and frequency throughout the territory of the Member State concerned.
- (b) Such seminars should run for at least 1 day (with a minimum of 6 hours of teaching time), and attendance from participants will be required for the whole duration of the seminar including breakout groups and workshops. Different aspects, such as inclusion of participants holding certificates in other categories of aircraft should be considered.
- (c) Some experienced FI(S)s currently involved with flying training and with a practical understanding of the recency requirements and the current instructional techniques should be included as speakers at these seminars.
- (d) The attendance form will be completed and signed by the organiser of the seminar as approved by the competent authority, following attendance and satisfactory participation by the FI(S).
- (e) The content of the FI(S) refresher seminar should be selected from the following:
- (1) new or current rules or regulations, with emphasis on knowledge of Part-SFCL and operational requirements;
 - (2) teaching and learning;
 - (3) instructional techniques;
 - (4) the role of the instructor;
 - (5) national regulations (as applicable);
 - (6) human factors;
 - (7) flight safety, incident and accident prevention;
 - (8) airmanship;
 - (9) legal aspects and enforcement procedures;
 - (10) navigational skills including new or current radio navigation aids;
 - (11) teaching sailplane cloud flying (if applicable);
 - (12) weather-related topics including methods of distribution; and
 - (13) any additional topic selected by the competent authority.
- (f) Formal sessions should allow for a presentation time of 45 minutes, with 15 minutes for questions. The use of visual aids is recommended, with interactive video and other teaching aids (where available) for breakout groups and workshops.

GM1 SFCL.360(a)(1)(i) FI(S) certificate – Recency requirements

ED Decision 2020/004/R

FREQUENCY OF INSTRUCTOR REFRESHER TRAINING

In order to maintain instructor privileges, point [SFCL.360\(a\)\(1\)\(i\)](#) requires FI(S) certificate holders to complete instructor refresher training once in 3 years. However, ATOs or DTOs may decide to provide more frequent internal standardisation/refresher training to their instructors.

AMC1 SFCL.360(a)(2) FI(S) certificate – Recency requirements

ED Decision 2020/004/R

DEMONSTRATION OF ABILITY TO INSTRUCT

- (a) The aim of the demonstration flight as per point [SFCL.360\(a\)\(2\)](#) is to confirm continued instructor competency.
- (b) The demonstration flight should be arranged to ensure that the FI(S) being checked demonstrates, on the ground and during at least one flight, knowledge, skills and attitudes relevant to the FI(S) task including at least all of the following:
 - (1) technical knowledge;
 - (2) ability to teach a sample of the ground course subjects and air exercises from the SPL training course;
 - (3) a sufficiently high standard of flying;
 - (4) application of instructing principles; and
 - (5) application of TEM.
- (c) The checking instructor should enter the successful completion of the demonstration flight into the logbook of the applicant.

SUBPART FE – FLIGHT EXAMINERS

SECTION 1 – GENERAL REQUIREMENTS

SFCL.400 Sailplane flight examiner certificates

Regulation (EU) 2020/358

(a) General

An examiner shall only carry out skill tests, proficiency checks or assessments of competence in accordance with this Annex if he or she:

- (1) holds:
 - (i) an SPL including privileges, ratings and certificates for which he or she is authorised to conduct skill tests, proficiency checks or assessments of competence, and the privileges to instruct for them;
 - (ii) an FE(S) certificate including privileges appropriate to the skill test, proficiency check or assessment of competence conducted, issued in accordance with this Subpart;
- (2) is entitled to act as PIC in a sailplane during the skill test, proficiency check or assessment of competence.

(b) Examinations conducted outside the territory of the Member States

- (1) By way of derogation from paragraph (a)(1), in the case of skills tests and proficiency checks performed outside the territory for which Member States are responsible under the Chicago Convention, the competent authority shall issue an examiner certificate to an applicant who holds a sailplane pilot licence that is compliant with Annex 1 to the Chicago Convention, provided that the applicant:
 - (i) holds at least a licence including, where relevant, privileges, ratings or certificates equivalent to those for which he or she is authorised to conduct skill tests or proficiency checks;
 - (ii) complies with the requirements established in this Subpart for the issue of the relevant examiner certificate;
 - (iii) demonstrates to the competent authority an adequate level of knowledge of Union aviation safety rules to be able to exercise the examiner privileges in accordance with this Annex.
- (2) The certificate referred to in paragraph (1) shall be limited to performing skill tests and proficiency checks:
 - (i) outside the territory for which Member States are responsible under the Chicago Convention; and
 - (ii) to a pilot who has sufficient knowledge of the language in which the test/check is provided.

SFCL.405 Limitation of privileges in case of vested interests

Regulation (EU) 2020/358

A sailplane examiner shall not conduct:

- (a) a skill test or assessment of competence of an applicant for the issue of a licence, rating or certificate to whom he or she has provided more than 50 % of the required flight instruction for the licence, rating or certificate for which the skill test or assessment of competence is taken; or
- (b) a skill test, proficiency check or assessment of competence whenever he or she feels that his or her objectivity may be affected.

GM1 SFCL.405 Limitation of privileges in case of vested interests

ED Decision 2020/004/R

Examples of a situation where the examiner should consider if their objectivity is affected are when the applicant is a relative or a friend of the examiner, or when they are linked by economic interests or political affiliations, etc.

GM1 SFCL.405(a) Limitation of privileges in case of vested interests

ED Decision 2020/004/R

EXAMINERS WHO PROVIDED INSTRUCTION TO THE CANDIDATE

Point [SFCL.405\(a\)](#) allows an examiner to have been involved, as flight instructor, into 50 % of the candidate's flight instruction. It is recommended that in such cases that 50 % should be spread throughout the course, and not performed towards the end of the course. ATOs and DTOs should plan and arrange assignments between instructors and students appropriately.

SFCL.410 Conduct of skill tests, proficiency checks and assessments of competence

Regulation (EU) 2020/358

- (a) When conducting skill tests, proficiency checks and assessments of competence, a sailplane examiner shall do all of the following:
 - (1) ensure that communication with the applicant can be established without language barriers;
 - (2) verify that the applicant complies with all the qualification, training and experience requirements of this Annex for the issue, revalidation or renewal of the licence, privileges, rating or certificate for which the skill test, proficiency check or assessment of competence is taken;
 - (3) make the applicant aware of the consequences of providing incomplete, inaccurate or false information related to his or her training and flight experience.
- (b) After completion of the skill test, proficiency check or assessment of competence, the sailplane examiner shall:
 - (1) inform the applicant of the results of the skill test, proficiency check or assessment of competence;

-
- (2) in the event of a pass in an assessment of competence for the revalidation or renewal, endorse the new expiry date on the applicant's licence or certificate, if specifically authorised for that purpose by the competent authority that is responsible for the applicant's licence;
 - (3) provide the applicant with a signed report of the skill test, proficiency check or assessment of competence and submit without undue delay copies of the report to the competent authority that is responsible for the applicant's licence, and to the competent authority that issued the examiner certificate. The report shall include:
 - (i) a declaration that the sailplane examiner has received information from the applicant regarding his or her experience and instruction, and found that experience and instruction comply with the applicable requirements of this Annex;
 - (ii) confirmation that all the required manoeuvres and exercises have been completed, as well as information on the verbal theoretical knowledge examination, when applicable. If an item of those categories has been failed, the examiner shall record the reasons for this assessment;
 - (iii) the result of the skill test, proficiency check or assessment of competence;
 - (iv) a declaration that the sailplane examiner has reviewed and applied the national procedures and requirements of the applicant's competent authority if the competent authority that is responsible for the applicant's licence is not the one that issued the examiner's certificate;
 - (v) a copy of the sailplane examiner certificate containing the scope of his or her privileges as sailplane examiner in the case of skill tests, proficiency checks or assessments of competence of an applicant whose competent authority is not the one that issued the examiner's certificate.
 - (c) The sailplane examiner shall maintain the records for five years with details of all skill tests, proficiency checks and assessments of competence performed and their results.
 - (d) Upon request by the competent authority that is responsible for the sailplane examiner certificate, or the competent authority that is responsible for the applicant's licence, the sailplane examiner shall submit all records and reports, and any other information, as required, for oversight activities.

AMC1 SFCL.410(b)(3) Conduct of skill tests, proficiency checks and assessments of competence

ED Decision 2020/004/R
APPLICATION AND REPORT FORM FOR THE SPL SKILL TEST OR PROFICIENCY CHECK

APPLICATION AND REPORT FORM FOR THE SPL SKILL TEST OR PROFICIENCY CHECK			
Tick as applicable	I hereby, in accordance with Annex III (Part-SFCL) to Regulation (EU) 2018/1976: <ul style="list-style-type: none"> <input type="checkbox"/> apply for the issue of a sailplane pilot licence (SPL). <input type="checkbox"/> report the completion of a proficiency check for SPL — recency. <input type="checkbox"/> report the completion of a proficiency check for sailplane cloud flying — recency. 		
1 Applicant's personal particulars:			
Applicant's last name(s):		First name(s):	
Date of birth:	Telephone:	Email:	
Address:		Country:	
Date:		Signature:	
2 Licence details			
Licence number (if applicable):			
Privileges: (tick as applicable)	<input type="checkbox"/> Sailplanes <input type="checkbox"/> TMGs		
FROM HERE TO BE COMPLETED BY THE EXAMINER			
3 Details of the skill test/proficiency check flight			
Date:	Sailplane/powered sailplane/TMG:	Registration:	
Aerodrome or site:	Take-off time:	Landing time:	Flight time:
Total flight time:			
4 Result of the test or check			
Skill test/proficiency check details (including information on oral theoretical knowledge examination, where applicable):			
Passed <input type="checkbox"/>	Partially passed <input type="checkbox"/>	Failed <input type="checkbox"/>	
5 Remarks			
Reasons and details in case of fail or partial pass/other remarks as necessary:			

6	Examiner's declarations and details	
I, the undersigning examiner: <ul style="list-style-type: none"> — have received information from the applicant regarding their experience and instruction, and found that experience and instruction comply with the applicable requirements of Annex III (Part-SFCL) to Regulation (EU) 2018/1976; — confirm that all the required manoeuvres and exercises have been completed, unless specified otherwise above in the case of fail or partial pass; — where applicable, have reviewed and applied the national procedures and requirements of the applicant's competent authority which is different from the competent authority that issued my examiner certificate. 		
Examiner's certificate number:		Examiner's SPL number:
Examiner's name (capital letters):		Date and examiner's signature:
7	Attachments	
Detailed report of skill test or proficiency check as per AMC1 SFCL.145 to be attached		
Copy of the FE(S) certificate (in cases where the competent authority of the applicant is different from the competent authority of the examiner)		

SECTION 2 – FLIGHT EXAMINER CERTIFICATE FOR SAILPLANES – FE(S)

SFCL.415 FE(S) certificate – Privileges and conditions

Regulation (EU) 2020/358

Subject to compliance of the applicant with point [SFCL.420](#) and with the following conditions, an FE(S) certificate shall be issued upon application with privileges to conduct:

- (a) skill tests and proficiency checks for the SPL, provided that the applicant has completed, on sailplanes, excluding TMGs, 300 hours of flight time as a pilot, including 150 hours or 300 launches of flight instruction;
- (b) skill tests for the extension of the SPL privileges to TMG in accordance with point [SFCL.150\(e\)](#), provided that the applicant has completed 300 hours of flight time on sailplanes, including 50 hours of flight instruction in TMGs;
- (c) assessments of competence for the issue of FI(S) certificates on sailplanes, provided that the applicant has:
 - (1) completed at least 500 hours of flight time as pilot on sailplanes, including, if the privileges of the FE(S) certificate will be exercised in:
 - (i) sailplanes, excluding TMGs, at least 10 hours or 30 launches instructing the applicant for an FI(S) certificate in sailplanes, excluding TMGs;
 - (ii) TMGs, at least 10 hours or 30 take-offs and landings instructing the applicant for an FI(S) certificate in TMGs;
 - (2) received specific training during an examiner standardisation course in accordance with point SFCL.430.

AMC1 SFCL.415(c)(2) FE(S) certificate – Privileges and conditions

ED Decision 2020/004/R

SPECIFIC TRAINING FOR EXAMINER PRIVILEGES RELATED TO THE FI(S) CERTIFICATE

Specific training for examiner privileges related to the FI(S) certificate should:

- (a) be completed under the supervision of an FE(S) who holds the privileges in accordance with point [SFCL.415\(c\)](#); and
- (b) include at least all of the following:
 - (1) the requirements of Part-SFCL for the FI(S) certificate;
 - (2) the contents of [AMC1 SFCL.345](#), [AMC2 SFCL.345](#) and [AMC3 SFCL.345](#); and
 - (3) the conduct of one assessment of competence for the FI(S) certificate which, if conducted during an initial examiner standardisation course in accordance with point [SFCL.430](#), should be completed in addition to the skill test or proficiency check for the SPL, as required by point SFCL.430(b)(1).

SFCL.420 FE(S) certificate – Prerequisites and requirements

Regulation (EU) 2020/358

Applicants for an FE(S) certificate shall:

- (a) comply with the requirements of point (a)(1)(i) and paragraph (a)(2) of point SFCL.400;
- (b) have completed the FE(S) standardisation course in accordance with point SFCL.430;
- (c) have completed an assessment of competence in accordance with point SFCL.445;
- (d) demonstrate relevant background related to the privileges of the FE(S) certificate; and
- (e) demonstrate that they have not been subject to any sanctions, including the suspension, limitation or revocation of any of his or her licences, ratings or certificates issued in accordance with this Annex, with Annex I (Part-FCL) to Regulation (EU) No 1178/2011, or with Annex III (Part-BFCL) to Regulation (EC) No 2018/395, for non-compliance with Regulation (EU) 2018/1139 and its delegated and implementing acts during the last three years.

AMC1 SFCL.420(d) FE(S) certificate – Prerequisites and requirements

ED Decision 2020/004/R

EVALUATION OF THE RELEVANT BACKGROUND OF AN APPLICANT

When evaluating the applicant's background, the competent authority should evaluate the personality and character of the applicant, and their cooperation with the competent authority.

The competent authority may also take into account whether the applicant has been convicted of any relevant criminal or other offenses, taking into account national law and principles of non-discrimination.

SFCL.430 FE(S) certificate – Standardisation course

Regulation (EU) 2020/358

- (a) Applicants for an FE(S) certificate shall take a standardisation course which is provided either by the competent authority or by an ATO or a DTO and approved by that competent authority.
- (b) The standardisation course shall be tailored to the sailplane flight examiner privileges sought and shall consist of theoretical and practical instruction, including, at least:
 - (1) the conduct of two skill tests, proficiency checks or assessments of competence for the SPL or associated ratings or certificates;
 - (2) instruction on the applicable requirements of this Annex and the applicable air operations requirements, the conduct of skill tests, proficiency checks and assessments of competence, and their documentation and reporting;
 - (3) a briefing on the following:
 - (i) national administrative procedures;
 - (ii) requirements for the protection of personal data;
 - (iii) examiner's liability;
 - (iv) examiner's accident insurance;

- (v) national fees; and
 - (vi) information on how to access the information contained in points (i) to (v) when conducting skill tests, proficiency checks or assessments of competence of an applicant whose competent authority is not the one that issued the examiner certificate.
- (c) An FE(S) certificate holder shall not conduct skill tests, proficiency checks or assessments of competence of an applicant whose competent authority is not the one that issued the examiner certificate, unless he or she has reviewed the latest available information containing the relevant national procedures of the applicant's competent authority.

AMC1 SFCL.430 FE(S) certificate – Standardisation course

ED Decision 2020/004/R

- (a) GENERAL
- (1) When issuing an approval for the conduct of FE(S) standardisation courses to an ATO or a DTO, the competent authority should monitor the execution of these courses through appropriate oversight measures.
 - (2) An FE(S) standardisation course should last at least 1 day, divided into theoretical and practical training.
 - (3) The competent authority, the ATO or the DTO should determine any further training required before presenting the candidate for the examiner assessment of competence.
- (b) CONTENT
- (1) Theoretical training
 - (i) The theoretical training should cover at least:
 - (A) the contents of [AMC2 SFCL.430](#) and the flight examiner manual (FEM);
 - (B) Part-SFCL and the related AMC and GM that are relevant to their duties;
 - (C) operational requirements and the related AMC and GM that are relevant to their duties;
 - (D) national requirements that are relevant to their examination duties;
 - (E) fundamentals of human performance and limitations that are relevant to flight examination;
 - (F) fundamentals of evaluation that are relevant to an applicant's performance; and
 - (G) the management system of ATOs and the organisational structure of DTOs;
 - (ii) Examiners should also be briefed on the protection requirements for personal data, liability, accident insurance and fees, as applicable in the Member State concerned.
 - (iii) All items above are the core knowledge requirements for an examiner and are recommended as the core course material. This core course material may be studied before the recommended examiner training is commenced. The core course may utilise any suitable training format.

- (2) Practical training
 - (i) Practical training should include at least:
 - (A) knowledge and management of the test for which the certificate is to be sought. These are described in the relevant modules in the FEM; and
 - (B) knowledge of the administrative procedures pertaining to that test or check.
 - (ii) For an initial examiner certificate, practical training should include the examination of the test profile sought, consisting of the conduct of at least two test or check profiles in the role of an examiner, including briefing, conduct of the skill test and proficiency check, assessment of the applicant to whom the test or check is given, debriefing and recording or documentation under the supervision of an examiner.

AMC2 SFCL.430 FE(S) certificate – Standardisation course

ED Decision 2020/004/R

STANDARDISATION ARRANGEMENTS FOR EXAMINERS

- (a) General
 - (1) An examiner should allow an applicant adequate time to prepare for a test or check.
 - (2) An examiner should plan a test or check flight so that all required exercises can be performed while allowing sufficient time for each of the exercises and with due regard to the weather conditions, traffic situation, ATC requirements and local procedures.
- (b) Purpose of a test or check
 - (1) Determination through practical demonstration during a test or check that an applicant has acquired or maintained the required level of knowledge and skill or proficiency.
 - (2) Improvement of training and flight instruction in ATOs or DTOs through feedback from examiners about items or sections of tests or checks that are most frequently failed.
 - (3) Assistance in maintaining and, where possible, improving air safety standards by having examiners display good airmanship and flight discipline during tests or checks.
- (c) Conduct of a test or check
 - (1) An examiner will ensure that an applicant completes a test or check in accordance with the Part-SFCL requirements and is assessed against the required test or check standards.
 - (2) Each item within a test or check section should be completed and assessed separately. The test or check schedule, as briefed, should normally not be altered by an examiner.
 - (3) A marginal or questionable performance of a test or check item should not influence an examiner's assessment of any subsequent items.
 - (4) An examiner should verify the requirements and limitations of a test or check with an applicant during the pre-flight briefing.
 - (5) When a test or check is completed or discontinued, an examiner should debrief the applicant and give reasons for items or sections failed. In case of a failed or discontinued skill test and proficiency check, the examiner should provide appropriate advice to assist the applicant in retests or rechecks.

- (6) Any comment on, or disagreement with, an examiner's test or check evaluation or assessment made during a debriefing will be recorded by the examiner on the test or check report, and will be signed by the examiner and countersigned by the applicant.
- (d) Examiner preparation
- (1) An examiner should supervise all aspects of the test or check flight preparation, including, where necessary, obtaining or assuring an ATC clearance/liaison.
 - (2) An examiner will plan a test or check in accordance with the Part-SFCL requirements. Only the manoeuvres and procedures set out in the appropriate test or check form will be undertaken. The same examiner should not re-examine a failed applicant without the agreement of the applicant.
- (e) Examiner approach
- An examiner should encourage a friendly and relaxed atmosphere both before and during a test or check flight. A negative or hostile approach should not be used. During the test or check flight, the examiner should avoid negative comments or criticisms and all assessments should be reserved for the debriefing.
- (f) Assessment system
- Although test or checks may specify flight test tolerances, an applicant should not be expected to achieve these at the expense of smoothness or stable flight. An examiner should make due allowance for unavoidable deviations due to turbulence, ATC instructions, etc. An examiner should terminate a test or check only either when it is clear that the applicant has not been able to demonstrate the required level of knowledge, skill or proficiency and that a full retest will be necessary or for safety reasons. An examiner will use one of the following terms for assessment:
- (1) a 'pass' provided that the applicant demonstrates the required level of knowledge, skill or proficiency and, where applicable, remains within the flight test tolerances for the licence or rating;
 - (2) a 'fail' provided that any of the following apply:
 - (i) the flight test tolerances have been exceeded after the examiner has made due allowance for turbulence or ATC instructions;
 - (ii) the aim of the test or check is not met;
 - (iii) the aim of exercise is met but at the expense of safe flight, violation of a rule or regulation, poor airmanship or rough handling;
 - (iv) an acceptable level of knowledge is not demonstrated;
 - (v) an acceptable level of flight management is not demonstrated; and
 - (vi) the intervention of the examiner is required in the interest of safety; and
 - (3) a 'partial pass' in accordance with the criteria shown in the relevant skill test appendix to Part-SFCL.
- (g) Method and contents of the test or check
- (1) Before undertaking a test or check, an examiner will verify that the sailplane intended to be used is suitable and appropriately equipped for the test or check. Aircraft that fall under points (a), (b), (c), or (d) of Annex I to the Basic Regulation can be used, provided

that they are subject to an authorisation as per point ORA.ATO.135 of Annex VII (Part-ORA) or point DTO.GEN.240 of Annex VIII (Part-DTO) to Regulation (EU) No 1178/2011.

- (2) A test or check flight will be conducted in accordance with the AFM.
- (3) A test or check flight will be conducted within the limitations contained in the operations manual of an ATO, or, if available, within the limitations placed by the DTO.
- (4) Contents

A test or check is comprised of:

- (i) oral examination on the ground (where applicable) which should include:
 - (A) sailplane general knowledge and performance;
 - (B) planning and operational procedures;
 - (C) theoretical knowledge in the common subjects as per point [SFCL.135\(a\)\(1\)](#) in cases where the applicant receives a credit in accordance with point [SFCL.140\(a\)](#), based on a licence the privileges of which were not exercised for more than 2 years; and
 - (D) other relevant items or sections of the test or check;
- (ii) pre-flight briefing which should include:
 - (A) test or check sequence;
 - (B) safety considerations.
- (iii) in-flight exercises which should include each relevant item or section of the test or check; and
- (iv) post-flight debriefing which should include:
 - (A) assessment or evaluation of the applicant;
 - (B) documentation of the test or check with the applicant's FI(S) present, if possible.
- (5) A test or check is intended to simulate a practical flight. Thus, an examiner may set practical scenarios for an applicant while ensuring that the applicant is not confused and air safety is not compromised.
- (6) When manoeuvres are to be flown by sole reference to instruments (proficiency check for sailplane cloud flying privileges), the examiner should ensure that a suitable method of screening is used to simulate flying in cloud.
- (7) An examiner should maintain a flight log and assessment record during the test or check for reference during the post-flight debriefing.
- (8) An examiner should be flexible with regard to the possibility of changes arising to pre-flight briefings due to ATC instructions, or other circumstances affecting the test or check.
- (9) Where changes arise to a planned test or check, an examiner should be satisfied that the applicant understands and accepts the changes. Otherwise, the test or check flight should be terminated.
- (10) Should an applicant choose not to continue a test or check for reasons considered inadequate by an examiner, the applicant will be assessed as having failed those items or

sections not attempted. If the test or check is terminated for reasons considered adequate by the examiner, only these items or sections not completed will be tested during a subsequent test or check.

- (11) An examiner may terminate a test or check at any stage, if it is considered that the applicant's competency requires a complete retest or recheck.

GM1 SFCL.430 FE(S) certificate – Standardisation course

ED Decision 2020/004/R

PLANNING OF TESTS AND CHECKS

- (a) An FE(S) should plan per day not more than:
- (1) a total of four skill tests or proficiency checks for the SPL; or
 - (2) a total of two assessments of competence for the FI(S) or FE(S) certificate.
- (b) An FE(S) should plan at least 2 hours for a skill test, proficiency check or assessment of competence, including pre-flight briefing and preparation, conduct of the test, check or assessment of competence, de-briefing, evaluation of the applicant and documentation.
- (c) The flight time for the skill test, proficiency check or assessment of competence must be sufficient to allow that all the test, check or assessment items can be completed. If this is not possible in one flight, additional flights have to be conducted. For the total duration of the flight time for the skill test, proficiency check or assessment of competence, the following values may be used as guidance:
- (1) 30 minutes or three launches or take-offs, as applicable, for an SPL skill test or proficiency check;
 - (2) 45 minutes or four launches or take-offs, as applicable, for an FI(S) assessment of competence.

SFCL.445 FE(S) certificate – Assessment of competence

Regulation (EU) 2020/358

An applicant for the initial issue of an FE(S) certificate shall demonstrate his or her competence as an FE(S), to an inspector from the competent authority or to a senior examiner specifically authorised to do so by the competent authority that is responsible for the FE(S) certificate. During the assessment of competence, the applicant shall conduct a skill test, proficiency check or assessment of competence, including briefing, conduct of the skill test, proficiency check or assessment of competence, and assessment of the person to whom the test, check or assessment is given, debriefing and recording documentation.

AMC1 SFCL.445 FE(S) certificate – Assessment of competence

ED Decision 2020/004/R

- (a) GENERAL
- The competent authority may nominate either one of its inspectors or a senior examiner to assess the competence of applicants for the FE(S) certificate.
- (b) DEFINITIONS

- (1) 'Inspector/senior examiner': the inspector of the competent authority or the senior examiner who is conducting the examiner competence assessment.
- (2) 'Examiner applicant': the person seeking certification as an examiner.
- (3) 'Candidate': the inspector/senior examiner who, for the purpose of conducting the assessment of competence, plays the role of a person being tested or checked by the examiner applicant.

(c) CONDUCT OF THE ASSESSMENT

An inspector/senior examiner will observe all examiner applicants conducting a test on a 'candidate' in a sailplane for which examiner certificate is sought. Items from the related training course and test or check schedule will be selected by the inspector/senior examiner for examination of the 'candidate' by the examiner applicant. Having agreed with the inspector/senior examiner the content of the test, the examiner applicant will be expected to manage the entire test. This will include briefing, the conduct of the flight, assessment and debriefing of the 'candidate'. The inspector/senior examiner will discuss the assessment with the examiner applicant before the 'candidate' is debriefed and informed of the result.

(d) BRIEFING THE 'CANDIDATE'

- (1) The 'candidate' should be given time and facilities to prepare for the test flight. The briefing should cover the following:
 - (i) the objective of the flight;
 - (ii) licensing checks, as necessary;
 - (iii) freedom for the 'candidate' to ask questions;
 - (iv) operating procedures to be followed;
 - (v) weather assessment;
 - (vi) operating capacity of 'candidate' and examiner;
 - (vii) aims to be identified by 'candidate';
 - (viii) simulated weather assumptions (for example, wind speed and visibility cloud base);
 - (ix) use of screens (if applicable);
 - (x) contents of the exercise to be performed;
 - (xi) agreed speed and handling parameters (e.g. maximum launch speeds);
 - (xii) use of R/T;
 - (xiii) respective roles of 'candidate' and examiner (for example, during emergency); and
 - (xiv) administrative procedures (for example, submission of a flight plan).
- (2) The examiner applicant should maintain the necessary level of communication with the 'candidate'. The following check details should be followed by the examiner applicant:
 - (i) the need to give the 'candidate' precise instructions;
 - (ii) responsibility for the safe conduct of the flight;
 - (iii) intervention by the examiner, when necessary;

- (iv) use of screens;
 - (v) liaison with ATC (where required) and the need for concise, easily understood intentions;
 - (vi) prompting the 'candidate' about required sequence of events (for example, following a launch failure); and
 - (vii) keeping brief, factual and unobtrusive notes.
- (e) **ASSESSMENT**
- The examiner applicant should refer to the flight test tolerances given in the relevant skill test. Attention should be paid to the following points:
- (1) questions from the 'candidate';
 - (2) giving the results of the test and any sections failed; and
 - (3) giving the reasons for failure.
- (f) **DEBRIEFING**
- The examiner applicant should demonstrate to the inspector the ability to conduct a fair, unbiased debriefing of the 'candidate' based on identifiable factual items. A balance between friendliness and firmness should be evident. The following points should be discussed with the 'candidate', at the applicant's discretion:
- (1) advising the candidate on how to avoid or correct mistakes;
 - (2) mentioning any other points of criticism noted;
 - (3) giving any advice considered helpful.
- (g) **RECORDING OR DOCUMENTATION**
- The examiner applicant should demonstrate to the inspector the ability to complete the relevant records correctly. These records may be:
- (1) the relevant test or check form;
 - (2) the licence entry; and
 - (3) the notification of failure form.
- (h) **DEMONSTRATION OF THEORETICAL KNOWLEDGE**
- The examiner applicant should demonstrate to the inspector a satisfactory knowledge of the regulatory requirements associated with the function of an examiner.

SFCL.460 FE(S) certificate – Validity, revalidation and renewal

Regulation (EU) 2020/358

- (a) An FE(S) certificate shall be valid for five years.
- (b) An FE(S) certificate shall be revalidated if its holder has:
 - (1) during the validity period of the FE(S) certificate, completed an examiner refresher course which is provided either by the competent authority or by an ATO or a DTO and approved by that competent authority, during which the holder shall receive theoretical knowledge instruction for refreshing and updating the knowledge relevant for sailplane examiners;

- (2) within the last 24 months preceding the end of the validity period of the certificate, demonstrated the ability to conduct skill tests, proficiency checks or assessments of competence to an inspector from the competent authority or an examiner specifically authorised to do so by the competent authority that is responsible for the FE(S) certificate.
- (c) An FE(S) certificate holder who also holds one or more examiner certificates for other aircraft categories in accordance with Annex I (Part-FCL) to Regulation (EU) No 1178/2011 or with Annex III (Part-BFCL) to Regulation (EU) 2018/395 may achieve combined revalidation of all examiner certificates held, in agreement with the competent authority.
- (d) If an FE(S) certificate has expired, its holder shall comply with the requirements of paragraph (b)(1) and of point [SFCL.445](#) before he or she can resume the exercise of the privileges of the FE(S) certificate.
- (e) An FE(S) certificate shall only be revalidated or renewed if the applicant demonstrates continued compliance with the requirements of point [SFCL.410](#) as well as with the requirements of point [SFCL.420\(d\)](#) and (e).

AMC1 SFCL.445; SFCL.460 FE(S) certificate – Assessment of competence; FE(S) certificate – Validity, revalidation and renewal

ED Decision 2020/004/R

QUALIFICATION OF SENIOR EXAMINERS

- (a) A senior examiner specifically tasked by the competent authority to observe skill tests or proficiency checks for the revalidation of examiner certificates should:
 - (1) hold a valid or current examiner certificate appropriate to the privileges being granted;
 - (2) have examiner experience level acceptable to the competent authority;
 - (3) have conducted a number of skill tests or proficiency checks as an FE(S).
- (b) The competent authority may conduct a pre-assessment of the applicant or candidate carrying out a skill test and proficiency check under the supervision of an inspector of the competent authority.
- (c) Applicants should be required to attend a senior examiner briefing, course or seminar arranged by the competent authority. The content and duration will be determined by the competent authority and should include:
 - (1) pre-course self-study;
 - (2) legislation;
 - (3) the role of the senior examiner;
 - (4) an examiner assessment; and
 - (5) national administrative requirements.
- (d) The validity of the authorisation should not exceed the validity of the examiner's certificate, and in any case should not exceed 5 years. The authorisation may be revalidated in accordance with procedures established by the competent authority.

AMC1 SFCL.460(b)(1) FE(S) certificate – Validity, revalidation and renewal

ED Decision 2020/004/R

EXAMINER REFRESHER COURSE

An FE(S) refresher course should be organised as a seminar that follows the content of the examiner standardisation course set out in [AMC1 SFCL.430](#).

AMC1 SFCL.460(b)(2) FE(S) certificate – Validity, revalidation and renewal

ED Decision 2020/004/R

DEMONSTRATION OF ABILITY TO CONDUCT SKILL TESTS, PROFICIENCY CHECKS AND ASSESSMENTS OF COMPETENCE

For the demonstration of the ability to conduct skill tests, proficiency checks and assessments of competence during a sailplane flight, the supervision by the senior examiner or the inspector from the competent authority may consist of:

- (a) monitoring of briefing, de-briefing as well as observing the flight from the ground; or
- (b) a role-played event where the senior examiner or the inspector from the competent authority will act as an 'examiner applicant' who is assessed by the applicant for revalidation or renewal of the examiner certificate.

CHAPTER 2 — CONTINUING AIRWORTHINESS

Please refer to [Easy Access Rules for Continuing Airworthiness \(Regulation \(EU\) No 1321/2014\)](#).

CHAPTER 3 — INITIAL AIRWORTHINESS

CS-22

PREAMBLE

ED Decision 2009/009/R

CS-22 Amendment 2

The following is a list of paragraphs affected by this amendment:

Subpart D	
CS 22.807	Amended (NPA 2008-11)
AMC 22.807(a)	Created (NPA 2008-11)

ED Decision 2008/008/R

CS-22 Amendment 1

The following is a list of paragraphs affected by this amendment:

Preamble	Preamble added (NPA 2007-12)
Subpart C	
CS 22.561	Amended (NPA 2007-12)
AMC 22.561	Created (NPA 2007-12)
AMC 22.561(b)(2)	Created (NPA 2007-12)
Subpart D	
CS 22.785	Amended (NPA 2007-12)
AMC 22.785(f)	Amended (NPA 2007-12)
CS 22.787	Amended (NPA 2007-12)

SUBPART A — GENERAL

CS 22.1 Applicability

ED Decision 2003/13/RM

- (a) This Airworthiness Code is applicable to sailplanes and powered sailplanes in the utility U and aerobatic A categories:—
- (1) sailplanes the maximum weight of which does not exceed 750 kg;
 - (2) single engined (spark- or compression-ignition) powered sailplanes the design value W/b^2 (weight to span²) of which is not greater than $3(W[\text{kg}], b[\text{m}])$ and the maximum weight of which does not exceed 850 kg; and
 - (3) sailplanes and powered sailplanes the number of occupants of which does not exceed two.
- (b) Reserved
- (c) Those requirements in this CS-22 which apply only to powered sailplanes are marginally annotated with the letter P. Requirements not so marked apply both to sailplanes and to powered sailplanes with engines stopped and engine or propeller retracted where appropriate. In these requirements the word 'sailplane' means both 'sailplane' and 'powered sailplane'.
- (d) Unless specifically stated otherwise, the term 'powered sailplane' includes those powered sailplanes which may be incapable of complying with [CS 22.51](#) and/or [CS 22.65\(a\)](#) and which must consequently be prohibited from taking off solely by means of their own power by a limitation in the Flight Manual. These are referred to in the text as 'Self-Sustaining Powered Sailplanes'. For Self-Sustaining Powered Sailplanes the additional requirements in [Appendix I](#) are applicable.

AMC 22.1(a) Applicability

ED Decision 2003/13/RM

CS-22 is not applicable to aeroplanes classified as hang-gliders and ultralights or microlights. The definitions of these aeroplanes differ from country to country. However, hang-gliders can be broadly defined as sailplanes that can take-off and land by using the pilot's muscular energy and potential energy.

Ultralights or microlights can be described as very low-energy aeroplanes, as some of their main characteristics are strictly limited. The following criteria are often used (alone or in combination): stalling speed, weight to surface area ratio, maximum take-off weight, maximum empty weight, fuel quantity, number of seats.

In addition, both hang-gliders and ultralights/microlights are usually not type-certificated, and CS-22 prescribes minimum standards for the issue of type certificates.

Appendix I – Self-sustaining powered sailplanes

ED Decision 2003/13/RM

(see [CS 22.1\(d\)](#))

1. Engine conditions & speeds

Two Conditions must be considered -

- (a) Engine extended and stopped (for cases related to engine idling).
- (b) Engine running at maximum power (for cases related to maximum continuous power, or all allowable power settings and also to [CS 22.175\(d\)\(5\)](#)).

2. Structure

[CS 22.361\(a\)\(1\)](#) is not applicable.

3. Equipment

[CS 22.1305](#) Power-plant instruments.

- (a) A tachometer or a suitable substitute -
 - (1) A simple indication (e.g. a green light) that the engine is producing the power upon which the performance information is based; and
 - (2) A simple indication (e.g. a red light) that the limiting engine r.p.m. has been reached except where it has been shown that the maximum engine r.p.m. cannot be exceeded at all speeds up to V_{NE} .
- (b) A fuel quantity indicator for each fuel tank. The installation of a simple device, e.g. a transparent tank, a sight gauge or a floating type of indicator is acceptable.
- (c) An oil temperature indicator or an oil temperature warning device (red light). (Except for two-stroke engines).
- (d) An oil pressure indicator or warning device (red light). (Except for two-stroke engines).
- (e) A cylinder head temperature indicator or warning device (red light) for each air-cooled engine when cowl flaps are fitted.
- (f) An elapsed-engine-time indicator is not required.
- (g) An oil quantity indicator, e.g. dipstick, unless the engine is a two-stroke type operating on pre-mixed fuel and oil.

CS 22.3 Sailplane categories

ED Decision 2003/13/RM

- (a) The Utility Category is limited to sailplanes intended for normal soaring flight. The following aerobatic manoeuvres may be permitted if demonstrated during type certification –
 - (1) spins;
 - (2) lazy eights, chandelles, stall turns and steep turns;
 - (3) positive loops.
- (b) Sailplanes intended for aerobatic manoeuvres additional to those permitted in the Utility Category must be certificated in the Aerobatic Category. The permitted aerobatic manoeuvres must be established during type certification.

- (c) Sailplanes may be certified in more than one category if the requirements of each requested category are met.
- (d) Powered sailplanes may be used for aerotowing sailplanes if they comply with [Appendix K](#).

AMC 22.3 Sailplane categories





ED Decision 2003/13/RM

- (1) Sailplanes may be used for cloud flying if permitted by the applicable operating rules if the equipment specified therein is installed and if they comply with [CS 22.73\(a\)](#).
- (2) See CS-22, Book 1, [Appendix E](#), Glossary of Aerobatic Manoeuvres.

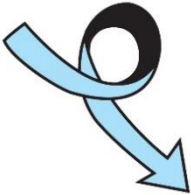
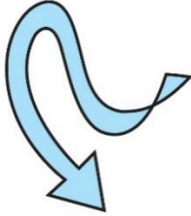
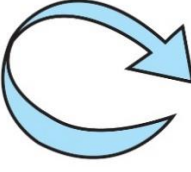
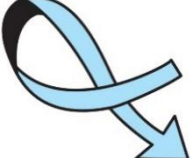
Appendix F – Glossary of aerobatic manoeuvres

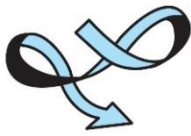
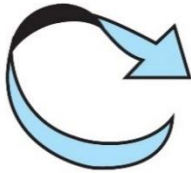
ED Decision 2003/13/RM

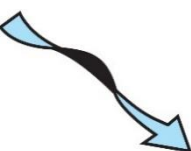
Manoeuvre	Belgium	France	Germany	Italy	Netherlands	Switzerland	United Kingdom
	Vrille	Vrille	Trudeln	Vite	Spin	Vrille	Spin
	Looping	Boucle	Looping	Gran volta	Loop	Looping	Loop
	Ranversement	Ranversement	Turn	Stall turn	Stall turn	Ranversement	Stall turn
	Chandelle (climbing)	Chandelle	Chandelle	Chandelle	Chandelle (climbing)	Chandelle	Chandelle (climbing)
	Chandelle (dive out)	Virage vertical	Kehre	Virata sfogata	Chandelle (dive out)	Kehre	Chandelle (dive out)

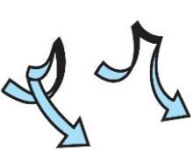
Manoeuvre	Belgium	France	Germany	Italy	Netherlands	Switzerland	United Kingdom
	Lazy eight	Huit paresseux	Lazy eight	Otto lento	Lazy eight	Lazy eight	Lazy eight
	Rétablissement normal	Rétablissement normal	Aufschwung	Imperiale	Half loop and half roll	Aufschwung	Half loop and half roll
	Retourne-ment	Retourne-ment	Abschwung	Rovescia-mento	Half roll and half loop	Retourne-ment	Half roll and half loop
	Tonneau	Tonneay	Rolle gesteuerte	Tonneau	Slow roll	Rolle gesteuerte	Slow roll
	Tonneau déclenché	Tonneay déclenché	Gerissene Rolle	Frullino	Flick roll	Gerissene rolle	Flick roll
	Tonneau barriqué	Tonneau barriqué	Fass- rolle	Tonneau lento	Barrel roll	Fassrolle	Barrel roll
	Cloche manche arrière et manche avant	Cloche manche arrière et manche avant	Männchen vorwärts und rückwärts	Scampanata	Tail slide	Männchen vorwärts und rückwärts	Tail slide

Appendix K – Aerotowing of Sailplanes by Powered Sailplanes

ED Decision 2003/13/RM

Applicability:

For powered sailplanes used for aerotowing sailplanes and for the powered sailplane - sailplane aerotowing combination itself (hereafter the combination is referred to as the “aerotow”), the following requirements apply in addition to those in the main code:

Notes: In the following the term “sailplane” is used for aerotowed sailplanes as well as for aerotowed powered sailplanes.

Aerotowing of more than one sailplane at a time needs further consideration and is not covered by this Appendix.

1. Subpart B - FLIGHT

1.1 (See [AMC 22 Appendix K paragraph 1.1](#))

1.2 [CS 22.51](#) is applicable to the aerotow, except that [22.51\(b\)\(2\)](#) is not applicable. Compliance must be shown at 500 m above sea level.

1.3 [CS 22.65](#) is applicable to the aerotow.
Compliance must be shown at 500 m above sea level.

1.4 A new paragraph CS 22.77 is added:

CS 22.77 AEROTOWING SPEEDS

The minimum aerotowing speed and the best-rate-of-climb aerotowing speed must be determined by flight test.

The minimum aerotowing speed must not be less than 1.3 V_{S1} of either the powered sailplane or the aerotowed glider, whichever is the higher.

1.5 [CS 22.143](#), except the sideslip condition under subpara (a), is to be applied also to the aerotow.

1.6 [CS 22.151\(c\) and \(d\)](#) are applicable to the aerotow.

1.7 [CS 22.207\(b\)](#) is amended to read:

(b) An audible artificial stall warning giving a clear and distinctive indication must be provided for the powered sailplane unless the stall warning is sufficiently clear and distinctive for the pilot, even under the additional work load when aerotowing.

1.8 [CS 22.207\(d\)](#) does not apply to the aerotowing powered sailplane.

1.9 [CS 22.233\(c\)](#) Powered sailplanes used for aerotowing sailplanes must be able to taxi and take-off without additional ground assistance.

2. Subpart C - STRUCTURE

2.1 [CS 22.307](#) applies to the aerotow.

2.2 [CS 22.581](#) is amended to read:

(a) It must be assumed that the aerotow initially is in stabilised level flight and that an aerotowing cable load of 50 daN (in the absence of a more rational analysis) acts at the aerotowing hook in the following directions:

(1) rearwards in the direction of the fuselage longitudinal axis;

- (2) in the plane of symmetry rearwards and downwards at an angle of 20° to the fuselage longitudinal axis;
 - (3) in the plane of symmetry rearwards and upwards at an angle of 40° to the fuselage longitudinal axis; and
 - (4) rearwards and sideways at an angle of 30° to the fuselage longitudinal axis.
- (b) It must be assumed that the aerotow is initially subjected to the same conditions as specified in [CS 22.581\(a\)](#) and the cable load due to surging suddenly increases to 1.0 Q_{nom} .

Note: It is assumed that only textile aerotowing cables are used.

- (1) The resulting cable load increment must be balanced by linear and rotational inertia forces. These additional loads must be superimposed on those arising from the conditions of [CS 22.581\(a\)](#).
- (2) Q_{nom} is the rated ultimate strength of the weak links to be used for the aerotowed sailplanes and shown to be suitable in operation.

2.3 [CS 22.585](#) is amended to read:

[CS 22.585](#) Strength of the Aerotowing Hook Attachment

The aerotowing hook attachment must be designed to carry a limit load of 1.5 Q_{nom} as defined in [CS 22.581\(b\)](#) acting in the directions specified in [CS 22.581](#).

3. Subpart D - DESIGN AND CONSTRUCTION

3.1 [CS 22.689](#) applies also for the aerotow release system of the powered sailplane.

3.2 [CS 22.711](#) applies also for the aerotowing powered sailplane and is amended by adding paragraphs (h) and (i):

- (h) Release mechanisms for aerotowing sailplanes must be installed so that there is no interference between the aerotow rope and any control surface throughout their full angular movement, with the aerotowed sailplane in any position as defined in [CS 22.581\(a\)](#).
- (i) The release mechanism of the aerotowing powered sailplane must be suitably protected against general degradation caused by mud and dirt, etc..
- (j) It must be possible for the pilot to visually check the aerotow cable situation.

3.3 [CS 22.713\(c\)](#) is applicable to the release mechanism of the aerotowing powered sailplane.

3.4 [CS 22.780](#) is amended by adding the following requirement:

Aerotowing cable release and throttle must be located and arranged to be capable of operation by the same hand.

3.5 A Note is added:

The requirements in [Appendix K](#) do not constitute all the requirements necessary to cover the installation of cable retracting devices. Compliance with further requirements may become necessary.

4. Subpart E - POWERPLANT INSTALLATION

4.1 A new paragraph CS 22.991 is added:

CS 22.991 Fuel Pumps

- (a) If for the purpose of [CS 22.951](#) a fuel pump is required for proper engine operation, an emergency pump must be provided to immediately supply fuel if the main pump fails. The power supply for the emergency pump must be independent of the power supply for the main pump.
- (b) If both the normal pump and the emergency pump operate continuously, a means or a procedure must be provided to indicate failure of either pump.
- (c) The operation of any fuel pump may not affect the engine operation so as to create a hazard regardless of the engine power setting or the functioning of the other fuel pump.

4.2 [CS 22.1047](#) must be applied to the aerotow.

5. Subpart F - EQUIPMENT

5.1 [CS 22.1305\(e\)](#) is amended to read:

- (e) a cylinder head temperature indicator or an indicator for the critical temperature determined in the cooling test.

5.2 [CS 22.1307](#) is amended by adding the following sentence:

- An easily removable rear-view mirror of sufficient strength and rigidity must be attached and so located that the pilot, when seated with the seat belts fastened, has full and unobstructed view of the aerotowed sailplane in any position as defined in [CS 22.581\(a\)](#). It must be possible to permanently observe the aerotowed sailplane without other pilot's tasks being affected and without major turning movements of the head.
- An Aerotow rope as specified by the applicant.

6. Subpart G - OPERATING LIMITATIONS AND INFORMATION

Note: This information should normally be furnished under Section 9 of the Flight Manual.

6.1 [CS 22.1529](#) applies to powered sailplanes equipped for aerotowing.

6.2 [CS 22.1583](#) is amended by adding the following paragraph (k):

- (k) Aerotowing of sailplanes

The following information concerning aerotowing of sailplanes must be furnished:

- (1) Maximum weight of the powered sailplane (if different from the value under (b)(1))
- (2) Maximum weight of the aerotowed sailplanes
- (3) Maximum weight of the combination powered sailplane and sailplane
- (4) The minimum value for the maximum allowable aerotow speed of the aerotowed sailplane (V_T)
- (5) Information that the powered sailplane shall lift off only after lift-off of the aerotowed sailplane
- (6) Rated ultimate strength for the weak link to be used for the aerotowing cable.
- (7) The specification of the aerotow rope (length, material, weak link)

6.3 As far as applicable for the intended purpose, [CS 22.1585](#) must be applied to the aerotow. In addition, the minimum aerotowing speed and the best-rate-of-climb speed for the

aerotow must be furnished. Furthermore, sailplane types whose relevant characteristics are comparable to those of the types used in the flight tests must be furnished as examples.

- 6.4 [CS 22.1587\(c\)](#) must be applied to the aerotow and is amended by the following requirements:

In addition, information about the degradation of performance in take-off distance due to long grass, rain drops or contamination of the wing (leading edge), as specified by the applicant, must be furnished.

AMC 22 - Appendix K paragraph 1.1

ED Decision 2003/13/RM

[AMC 22.21](#) applies to the aerotow and is amended by introducing a new paragraph (4):

- (4) For the proof of compliance with the requirements of CS-22, Book 1, Subpart B during the aerotowing of sailplanes by powered sailplanes, tests with at least three different representative sailplane types covering the whole permissible range of aerotowed sailplanes should be conducted. During these tests, the weights of the aerotowing powered sailplane and of the sailplane, the aerodynamic characteristics, speed range and ground handling characteristics should be combined appropriately so as to obtain conservative results.

SUBPART B — FLIGHT

GENERAL

CS 22.21 Proof of compliance

ED Decision 2003/13/RM

- (a) Each requirement of this Subpart must be met at each appropriate combination of weight and c.g. within the range of loading conditions for which certification is requested. This must be shown:
 - (1) by test upon a sailplane of the type for which certification is requested or by calculations based on and equal in accuracy to the result of testing; and,
 - (2) by systematic investigation of each critical combination of weight and c.g.
- (b) Compliance must be established for all configurations (such as position of air brakes, wing-flaps, landing gear etc.) at which the sailplane will be operated except as otherwise stated. In demonstrating compliance, the power-plant or propeller, if retractable, must be retracted, except as otherwise stated.

AMC 22.21 Proof of compliance

ED Decision 2003/13/RM

- (1) Instrumentation for flight test
 - (a) For test purposes the sailplane should be equipped with suitable instruments for conducting the required measurements and observations in a simple manner. If reliable results cannot be obtained otherwise, the Agency may request the installation of special test equipment.
 - (b) At an early stage in the programme the accuracy of the instruments and their correction curves should be determined, and particular attention should be paid to the position error of the air-speed indication system; the influence of the configuration of the sailplane should also be accounted for.
- (2) Prior to flight test, the following ground tests should be conducted:
 - (a) Measurement of:
 - (i) control circuit stiffness;
 - (ii) friction of controls;
 - (iii) control cable tension of closed control circuits; and
 - (iv) maximum deflection of control surfaces and wing-flaps.

- (3) Functioning tests.

Before starting the flight tests all ground functioning tests should be carried out; especially the functioning of the towing hook should be tested in operation for all cable angles and forces which may occur.

CS 22.23 Load distribution limits

ED Decision 2003/13/RM

- (a) The ranges of weight and c.g. within which the sailplane may be safely operated must be established and must include the range for lateral c.g. if possible loading conditions can result in significant variation. Compliance must be shown over the lateral c.g. range and over a longitudinal c.g. range between the foremost limit of the c.g. and 1% of the standard mean chord or 10 mm, whichever is greater, aft of the aftmost limit of the c.g.
- (b) The c.g. range must not be less than that which corresponds to the weight of each occupant, including parachute, varying between 110 kg and 70 kg, without the use of ballast as defined in [CS 22.31\(c\)](#).

AMC 22.23 Load distribution limits

ED Decision 2003/13/RM

Significant variations of lateral c.g. are only likely to occur on sailplanes equipped for the carriage of expendable ballast in the wings. Such variations may result from any permitted intentional asymmetric loading or from levels of asymmetric loading which might realistically be expected to occur unintentionally, particularly if flight is permitted with partly-filled tanks. In this case, the range of lateral c.g. considered should not be less than the greater of:-

- (1) Any intentional asymmetric loading that is permitted; and
- (2) The level of asymmetry that might realistically be expected to occur inadvertently, taking account of the design of the system and the likely accuracy of loading. In the absence of a more rational analysis to establish any greater or lesser value, an asymmetry of 10 litres, or 10% of the combined capacity of each symmetrical pair of tanks, whichever is the greater, may be assumed.

CS 22.25 Weight limits

ED Decision 2003/13/RM

- (a) *Maximum weight.* The maximum weight must be established so that it is:
 - (1) Not more than:
 - (i) the highest weight selected by the applicant;
 - (ii) the design maximum weight, which is the highest weight at which compliance with each applicable structural loading condition of this Part is shown; or
 - (iii) the highest weight at which compliance with each applicable flight requirement of this Part is shown.
 - (2) Not less than the weight which results from the empty weight of the sailplane, plus a weight of occupant(s) and parachute(s) of 110 kg for a single seat sailplane or 180 kg for a two seat sailplane, plus the required minimum equipment, plus any expendable ballast and for a powered sailplane sufficient fuel for at least half an hour of flight at maximum continuous power.
- (b) The minimum weight must be established so that it is not more than the sum of:
 - (1) the empty weight determined under [CS 22.29](#); and
 - (2) a weight of occupant and parachute of 55 kg, plus any ballast as defined in [CS 22.31\(c\)](#).

CS 22.29 Empty weight and corresponding c.g.

ED Decision 2003/13/RM

- (a) The empty weight and corresponding c.g. must be determined by weighing the sailplane:
- (1) with:
 - (i) fixed ballast;
 - (ii) required minimum equipment;
 - (iii) for a powered sailplane, unusable fuel, maximum oil and, where appropriate, engine coolant and hydraulic fluid.
 - (2) excluding:
 - (i) weight of occupant(s) and parachute(s);
 - (ii) other readily removable items of load.
- (b) The condition of the sailplane at the time of determining empty weight must be one that is well defined and easily repeated.

CS 22.31 Ballast

ED Decision 2003/13/RM

There are three types of ballast:

- (a) fixed ballast intended for correcting a deficiency in the sailplane's balance;
- (b) expendable ballast which can be jettisoned in flight and which serves to increase the weight and consequently the speed of the sailplane; and
- (c) removable ballast used to supplement the weight of an occupant and parachute (when lower than 70 kg) in order to keep the c.g. position within limits. This ballast can be adjusted before, but not during, flight.

PERFORMANCE

CS 22.45 General

ED Decision 2003/13/RM

Compliance with performance requirements of this Subpart must be shown for still-air in standard atmosphere and at sea-level.

CS 22.49 Stalling speed

ED Decision 2003/13/RM

- (a) V_{S0} is the stalling speed (CAS), if obtainable, or the minimum steady speed at which the sailplane is controllable, with:
- (1) landing gear extended;
 - (2) wing-flaps in the landing position;
 - (3) air brakes retracted or extended whichever position results in the lowest value of V_{S0} ;
 - (4) maximum weight; and
 - (5) c.g. in the most unfavourable position within the allowable range.
 - (6) For a powered sailplane:
 - (i) the engine idling (throttle closed);
 - (ii) propeller in the take-off position;
 - (iii) cowl flaps closed.
- (b) The stalling speed in the landing configuration must not exceed:
- (1) 80 km/h with:
 - (i) air brakes retracted; and at
 - (ii) maximum weight with water ballast tanks empty.
 - (2) 90 km/h with:
 - (i) airbrakes retracted, and at
 - (ii) maximum weight with water ballast.
 - (3) 95 km/h with:
 - (i) airbrakes fully extended; and at
 - (ii) maximum weight with water ballast.
- (c) V_{S1} is the stalling speed (CAS), if obtainable, or the minimum steady speed at which the sailplane is controllable with the:
- (1) sailplane in the configuration existing in the test in which V_{S1} is being used; and
 - (2) weight used when V_{S1} is being used as a factor to determine compliance with a required performance standard.
 - (3) For a powered sailplane:
 - (i) the engine idling (throttle closed);

- (ii) propeller in the take-off position;
 - (iii) cowl flaps closed.
- (d) Reserved.
- (e) V_{S0} and V_{S1} must be determined by flight tests using the procedure specified in [CS 22.201](#).

CS 22.51 Take-off

ED Decision 2003/13/RM

- (a) For a powered sailplane the take-off distance at maximum weight and in zero wind, from rest to attaining a height of 15 m must be determined and must not exceed 500 m when taking off from a dry, level, hard surface. In demonstration of the take-off distance, the powered sailplane must be allowed to reach the selected speed promptly after lifting off and this speed must be maintained throughout the climb.
- (b) The selected speed must not be less than;
- (1) $1.3 V_{S1}$, or
 - (2) any lesser speed, not less than $1.15 V_{S1}$, that is shown to be safe under all reasonably expected operating conditions, including turbulence and complete engine failure.

CS 22.65 Climb

ED Decision 2003/13/RM

- (a) For a powered sailplane the time for climb from leaving the ground up to 360 m above the field must not exceed four minutes with:
- (1) not more than take-off power;
 - (2) landing gear retracted;
 - (3) wing-flaps in take-off position;
 - (4) cowl flaps (if any) in the position used in the cooling tests.
- (b) For self-sustaining powered sailplanes, the maximum altitude that can be sustained must be determined.

CS 22.71 Rate of descent

ED Decision 2003/13/RM

For a powered sailplane the smallest rate of descent in power-off configuration at maximum weight and most unfavourable c.g. position must not exceed the following limits:

- (a) with a single-seater powered sailplane, 1.0 m/s;
- (b) with a two-seater powered sailplane, 1.2 m/s.

CS 22.73 Descent, high speed

ED Decision 2003/13/RM

It must be shown that the sailplane with the airbrakes extended, will not exceed V_{NE} in a dive at an angle to the horizon of:

-
- (a) 45° when the sailplane is approved for cloud flying and/or aerobatics when certificated in the Aerobatic or Utility Category;
 - (b) in other cases
 - (i) 30°
 - (ii) less than 30° when a rate of descent of more than 30 m/s can be achieved.

CS 22.75 Descent, approach

ED Decision 2003/13/RM

It must be shown that the sailplane has a glide slope not flatter than one in seven at a speed of $1.3 V_{S0}$ with air brakes extended at maximum weight.

CONTROLLABILITY AND MANOEUVRABILITY

CS 22.143 General

ED Decision 2003/13/RM

- (a) It must be possible to make a smooth transition from one flight condition to another (including turns and slips) without exceptional piloting skill, alertness or strength, and without danger of exceeding the limit load factor, under any probable operating condition, and, additionally, in the case of a powered sailplane, with the engine running at all allowable power settings. (See [AMC 22.143\(a\)](#))
- (b) Any unusual flying characteristics observed during the flight tests required to determine compliance with the flight requirements and any significant variations in flight characteristics caused by rain must be determined. In the case of a powered sailplane this requirement must be met with the engine running at all allowable powers. (See [AMC 22.143\(b\)](#))
- (c) If marginal conditions exist with regard to required pilot strength, the 'strength of pilots' limits must be shown by quantitative tests. In no case may the limits exceed those prescribed in the following table. In the case of a powered sailplane this requirement must be met with the engine running at all allowable powers.

Force applied at hand grip or rudder pedal	Pitch	Roll	Yaw	Air brakes, towing, release, wing-flaps, landing gear
	daN	daN	daN	daN
(a) temporary application				
hand	20	10		20
feet			40	
(b) prolonged application				
hand	2.0	1.5		
feet			10	

AMC 22.143(a) Controllability and Manoeuvrability

ED Decision 2003/13/RM

General

Compliance with [22.143\(a\)](#) should include the extension of airbrakes at speeds up to $1.05 V_{NE}$. The time to extend airbrakes should not exceed 2 seconds.

AMC 22.143(b) Controllability and Manoeuvrability

ED Decision 2003/13/RM

General

The characteristics to be noted should include stalling speeds and stalling behaviour.

CS 22.145 Longitudinal control

ED Decision 2003/13/RM

- (a) It must be possible at any speed below $1.3 V_{S1}$ to pitch the nose downwards so that a speed equal to $1.3 V_{S1}$ can be reached promptly.
 - (1) Test conditions: all possible configurations and trimmed at $1.3 V_{S1}$.
- (b) It must be possible throughout the appropriate flight envelope to change the configuration (landing gear, air brakes, wing-flaps etc.) without exceptional piloting skill and without exceeding the control forces defined in [CS 22.143\(c\)](#).
- (c) It must be possible, without exceptional piloting skill, to maintain the sailplane in steady straight flight:
 - (1) in towed flight, when the wing-flap configuration is changed within the range of permissible flap settings during steady straight flight;
 - (2) when retraction or extension of the airbrakes is made at speeds between $1.1 V_{S1}$ and $1.5 V_{S1}$, where V_{S1} is the stalling speed with airbrakes retracted or extended, whichever is the higher, for a given flap position.
 - (3) when gradual change of the wing-flap configuration within the range of permissible flap settings is made during steady horizontal flight at $1.1 V_{S1}$ with simultaneous application of maximum continuous power.

CS 22.147 Lateral and directional control

ED Decision 2003/13/RM

Using an appropriate combination of controls it must be possible to reverse the direction of a turn with a 45° bank in the opposite direction within $b/3$ seconds (b is the span in metres) when the turns are made at a speed of $1.4 V_{S1}$ with wing-flaps in the most positive en-route position, air brakes and, where applicable, landing gear retracted and without significant slip or skid.

CS 22.151 Aerotowing

ED Decision 2003/13/RM

- (a) If the sailplane is equipped for aerotowing, aerotows must be demonstrated at speeds up to V_T without:
 - (1) excessive control forces and displacements for maintaining the wings at zero bank angle and in keeping a steady flight path;
 - (2) control forces exceeding those given in [CS 22.143](#) at speeds up to V_T ;
 - (3) difficulty being experienced in regaining normal towing position after the sailplane has been displaced laterally or vertically; and
 - (4) any possibility, at the release, of the cable end or ends catching onto any part of the sailplane.
- (b) Tests must be carried out with crosswind components not less than $0.2 V_{S0}$ or 15 km/h, whichever is the greater.
- (c) Compliance with the following requirements must be shown:
 - (1) With the sailplane on tow in the normal towing position it must be displaced laterally relative to the towing aircraft by the use of rudder and aileron, to give an initial

disturbance in bank of 30°. The pilot must then be able to regain the normal towing position without exceptional piloting skill.

- (2) The sailplane must be flown in a high towing position (approximately 15° above the flight path of the towing aircraft), and also in a low towing position (below the wake of the towing aircraft). In each case the pilot must be able to regain the normal towing position without exceptional piloting skill.
 - (3) In conditions associated with the early stages of the aerotow, any pitching tendency of the sailplane must be immediately controllable, without exceptional piloting skill, under any combinations of allowable towing conditions.
- (d) A suitable range of cable lengths must be determined.
- (e) Tests must be repeated for each location of the towing release mechanism and each configuration for which certification for aerotowing is requested.

AMC 22.151(c)(3) Aerotowing

ED Decision 2003/13/RM

In demonstrating compliance with this requirement, in addition to the requirements of [CS 22.21\(a\) and \(b\)](#), the effects of at least the following should be investigated:

- (1) Variations of tow cable length
- (2) Variations of pitch trim settings
- (3) Acceleration along the longitudinal axis of the sailplane
- (4) Snatch loads on tow
- (5) Wind gradient due to ground boundary layer effects.

CS 22.152 Winch-launching and auto-tow launching

ED Decision 2003/13/RM

- (a) If the sailplane is equipped for winch-launching, or auto-tow launching, such launches must be demonstrated at speeds up to V_w , without:
- (1) difficulty being experienced in maintaining the wings at zero bank angle when leaving the ground and in effecting a release;
 - (2) control forces exceeding those given in [CS 22.143](#) or excessive control displacements;
 - (3) excessive pitching oscillation;
 - (4) push forces during the climb. If a trimming device is fitted, the position used during the climb must be stated.
- (b) Tests must be carried out with crosswind components not less than $0.2 V_{S0}$ or 15 km/h, whichever is the greater.
- (c) Tests must be made for each location and arrangement of the release mechanism and for each configuration for which certification for winch-launching or auto-tow launching is requested.

AMC 22.152 Winch-launching and auto-tow launching

ED Decision 2003/13/RM

For showing compliance with the winch-launching requirements at least 6 winch-launches should be made, covering the range of speeds up to V_w . During these launches a range of release points should be selected along the flight path to cover the normal operating range and the release in emergency.

CS 22.153 Approach and landing

ED Decision 2003/13/RM

- (a) With a crosswind component of not less than $0.2 V_{S0}$ or 15 km/h, whichever is the greater, it must be possible to perform normal approaches and landings until the sailplane comes to a stop, without exceptional piloting skill and without encountering any uncontrollable ground-looping tendency.
- (b) After touchdown there must be no undue tendency to ground loop, pitching oscillation or nose over.
- (c) The use of air brakes during the approach must not cause excessive variation of control force or control displacement nor affect the controllability of the sailplane, when it is brought into use at any allowable speed down to $1.2 V_{S1}$, where V_{S1} is appropriate to the configuration with air brakes retracted or extended, whichever gives the greater value.

CS 22.155 Elevator control force in manoeuvres

ED Decision 2003/13/RM

The elevator control forces during turns or when recovering from manoeuvres must be such that an increase in load factor causes an increase in control force. The minimum value of this force for a stabilized turn with a 45° bank at $1.4 V_{S1}$ must be 0.5 daN, with the controls trimmed to maintain the sailplane in equilibrium at $1.4 V_{S1}$ in steady straight flight with wing-flaps in the most critical position, air brakes and, where applicable, landing gear retracted.

TRIM

CS 22.161 Trim

ED Decision 2003/13/RM

- (a) *General.* Each sailplane must meet the trim requirements of this paragraph after being trimmed and without further pressure upon, or movement of, the primary controls or their corresponding trim controls by the pilot.
- (b) Lateral and directional trim
- (1) *Lateral trim.* The sailplane must be capable of being so trimmed that there is no tendency for the sailplane when in straight flight at $1.4 V_{S1}$ with wing-flaps in all en-route positions, air brakes, and where applicable, landing gear retracted, to turn or bank, when the aileron control is released and the rudder control held fixed in the neutral position.
- (2) *Directional trim.* The sailplane must be capable of being so trimmed that there is no tendency for the sailplane, when in straight flight at $1.4 V_{S1}$ with wing-flaps in all en-route positions, air brakes, and where applicable, landing gear retracted, to yaw when the rudder control is released and the aileron control held fixed in the neutral position.
- (c) Longitudinal trim
- (1) If the sailplane has no in-flight adjustable trimming device, the trim speed must be between $1.2 V_{S1}$ and $2.0 V_{S1}$ for all c.g. positions.
- (2) If the sailplane has an in-flight adjustable trimming device, the following requirements must be met without further pressure upon or movement of the primary control or the corresponding trim control:
- (i) the sailplane must maintain trim with wing-flaps in the landing position, the air brakes retracted and landing gear extended within the speed range between $1.2 V_{S1}$ and $2.0 V_{S1}$;
- (ii) in towed flight the sailplane must maintain trim within the speed range between $1.4 V_{S1}$ and V_T ;
- (iii) In the most adverse out-of-trim condition, the control force must be less than 20 daN between $1.1 V_{S1}$ and $1.5 V_{S1}$.
- (3) For powered sailplanes, retraction and extension of the power-plant or propeller must not produce excessive trim changes.
- (4) The powered sailplane, with the engine operating, must maintain longitudinal trim during;
- (i) a climb with maximum continuous power at a speed V_Y with landing gear retracted and wing-flaps in the take-off position;
- (ii) level flight at all speeds between V_Y and $0.9 V_H$, with the landing gear retracted and wing-flaps in positions appropriate to each speed.

STABILITY

CS 22.171 General

ED Decision 2003/13/RM

The sailplane must meet the conditions of [CS 22.173](#) through [CS 22.181](#) inclusive. In addition the sailplane must show suitable stability and control ‘feel’ in any condition normally encountered in service.

CS 22.173 Static longitudinal stability

ED Decision 2003/13/RM

- (a) Under the conditions and throughout the speed range specified in [CS 22.175](#):
- (1) The slope of the curve, stick force versus speed, must be positive and have a value such that any significant speed change will cause a variation in stick force plainly perceptible to the pilot.
 - (2) The slope of the curve, stick displacement versus speed, must not be negative, except that a negative slope may be acceptable provided that it can be demonstrated that there is no difficulty in control. (See [AMC 22.173\(a\)](#))
- (b) The air speed must return to within $\pm 15\%$ or ± 15 km/h of the original trimmed speed, whichever is the greater when the control force is slowly released at any trimmable speed up to V_{NE} and where applicable V_{NE} and down to the appropriate minimum speed for steady unstalled flight. In addition, for a powered sailplane with the engine running, this requirement must be met at all allowable power settings. (See [AMC 22.173\(b\)](#))

AMC 22.173(a)(1) Static longitudinal stability

ED Decision 2003/13/RM

Compliance with this requirement can be assumed, if the slope of the curve, stick force versus speed, is at least 1 N per 10 km/h at all speeds up to V_{NE} .

AMC 22.173(b) Static longitudinal stability

ED Decision 2003/13/RM

- (1) In flight demonstration, the sailplane should be trimmed in steady flight and the speed should be increased by approximately 20% by moving the control column. The force on the column should then be relaxed very slowly, so as to avoid speed oscillation, and the speed at which the sailplane settles should be noted. The test should be repeated with the speed being decreased by approximately 20%.
- (2) Suitable minimum and maximum trimmed speeds are:
 - (a) Wing-flaps neutral (see [AMC 22.335](#)): $1.3 V_{S1}$ and the maximum trim speed but not exceeding $0.84 V_{NE}$.
 - (b) Wing-flaps in the landing position: $1.3 V_{S0}$ and the minimum trim speed, but not exceeding $0.84 V_{FE}$.
- (3) Where no in-flight trimming device is fitted, the test should be made at the trimmed speed. In such case, the speed at which the force on the column is relaxed need not exceed V_{NE} or V_{FE} as appropriate, and need not be less than the minimum speed for steady unstalled flight.

CS 22.175 Demonstration of static longitudinal stability

ED Decision 2003/13/RM

The stick force/speed curve must have a stable slope in the following conditions:

- (a) *Cruising configuration:*
 - (1) at all speeds between $1.1 V_{S1}$ and V_{NE} ;
 - (2) wing-flaps in the position for cruising and for circling flight;
 - (3) landing gear retracted;
 - (4) sailplane trimmed at $1.4 V_{S1}$ and $2 V_{S1}$ (if fitted with a trimming device); and
 - (5) air brakes retracted.
- (b) *Approach:*
 - (1) at all speeds between $1.1 V_{S1}$ and V_{FE} ;
 - (2) wing-flaps in the landing position;
 - (3) landing gear extended;
 - (4) sailplane trimmed at $1.4 V_{S1}$ (if fitted with a trimming device); and
 - (5) air brakes both retracted and extended.
- (c) *Climb for powered sailplane:*
 - (1) at all speeds between $0.85 V_Y$ or $1.05 V_{S1}$, whichever is higher, and $1.15 V_Y$.
 - (2) landing gear retracted;
 - (3) wing-flaps in the position for climb;
 - (4) maximum weight;
 - (5) maximum continuous power; and
 - (6) sailplane trimmed at V_Y (if fitted with a trimming device).
- (d) *Cruise for powered sailplane:*
 - (1) at all speeds between $1.3 V_{S1}$ and V_{NE} ;
 - (2) landing gear retracted;
 - (3) wing-flaps retracted or, in the case of flaps approved for use in en-route flying, in all appropriate positions;
 - (4) maximum weight,
 - (5) power for level flight at $0.9 V_H$; and
 - (6) sailplane trimmed for level flight (if fitted with a trimming device).
- (e) *Approach for powered sailplane:*
 - (1) at all speeds between $1.1 V_{S1}$ and V_{FE} ;
 - (2) wing-flaps in the landing position;
 - (3) landing gear extended;
 - (4) sailplane trimmed at $1.5 V_{S1}$ (if fitted with a trimming device);

- (5) air brakes both retracted and extended;
- (6) engine idling (throttle closed); and
- (7) propeller in take-off position.

AMC 22.175 Demonstration of static longitudinal stability

ED Decision 2003/13/RM

- (1) With air brakes extended, qualitative tests are normally acceptable.
- (2) Wing-flap positions should include negative positions, where provided. (See [AMC 22.335](#))

CS 22.177 Lateral and directional stability

ED Decision 2003/13/RM

- (a) With the sailplane in straight steady flight, and when the aileron and rudder controls are gradually applied in opposite direction, any increase in sideslip angle must correspond to an increased deflection of the lateral control. This behaviour need not follow a linear law.
- (b) In a sideslip any control force reversal must not be such as to require exceptional piloting skill to control the sailplane.

CS 22.181 Dynamic stability

ED Decision 2003/13/RM

Any short period oscillations occurring between the stalling speed and V_{DF} , must be heavily damped with the primary controls:

- (a) Free.
- (b) Fixed.

In the case of a powered sailplane this requirement must be met with the engine running at all allowable powers.

STALLS

CS 22.201 Wings level stall

ED Decision 2003/13/RM

- (a) Stall demonstrations must be conducted by reducing the speed by approximately 2 km/h per second until either a stall results as evidenced by a downward pitching motion or rolling motion not immediately controllable or until the longitudinal control reaches the stop. It must be possible to produce and correct roll and yaw by unreversed use of the controls until the stall occurs.
- (b) It must be possible to prevent more than 30° of roll by normal use of the controls during recovery. There must be no uncontrollable tendency of the sailplane to spin.
- (c) Stalling behaviour must not be unduly sensitive to sideslip. (See [AMC 22.201\(c\)](#))
- (d) The loss of altitude from the beginning of the stall until regaining level flight by applying normal procedures and the maximum pitch attitude below the horizon must be determined. (See [AMC 22.201\(d\)](#))
- (e) With the sailplane in straight flight at $1.2 V_{S1}$ in the configuration appropriate to winch-launching by pulling rapidly on the control stick, a pitch attitude approximately 30° above the horizon must be achieved and the resulting stall must not be severe and such as to make prompt recovery difficult.
- (f) Compliance with the requirements of sub-paragraphs (a) through (d) and (g) of this paragraph must be shown under the following conditions:
 - (1) wing-flaps in any position;
 - (2) air brakes retracted and extended;
 - (3) landing gear retracted and extended;
 - (4) sailplane trimmed to $1.5 V_{S1}$ (if fitted with a trimmer);
 - (5) additionally, for powered sailplanes:—
 - (i) cowl flaps in appropriate configuration;
 - (ii) power:
 - engine idling, and
 - 90% of maximum continuous power;
 - (iii) propeller in take-off position
- (g) For sailplanes equipped to carry water ballast, it must be shown that it is possible to regain level flight without encountering uncontrollable rolling or spinning tendencies in the stall demonstration of sub-paragraph (a) of this paragraph with the asymmetry that may result from any single malfunction of the system.

AMC 22.201(c) Wings level stall

ED Decision 2003/13/RM

Yawing angles up to 5° should not appreciably change the stalling characteristics.

AMC 22.201(d) Wings level stall

ED Decision 2003/13/RM

The loss of altitude during the stall is the difference between the altitude at which the stall occurs and that altitude at which level flight is regained.

CS 22.203 Turning flight stalls

ED Decision 2003/13/RM

- (a) When stalled during a co-ordinated 45° banked turn, it must be possible to regain normal level flight without encountering uncontrollable rolling or spinning tendencies. Compliance with this requirement must be shown under the conditions of [CS 22.201\(f\)](#) that result in the most critical stall behaviour of the sailplane. In any case the landing configuration, with airbrakes retracted and extended, must be investigated.
- (b) The loss of altitude from beginning of the stall until regaining level flight by applying normal procedures must be determined.

CS 22.207 Stall warning

ED Decision 2003/13/RM

- (a) Except as provided by 22.207(d), there must be a clear and distinctive stall warning with air brakes, wing-flaps and landing gear in any normal position, both in straight and in turning flight. In the case of a powered sailplane compliance with this requirement must also be shown with the engine running in the conditions prescribed in [CS 22.201\(f\)\(5\)](#).
- (b) The stall warning may be furnished either through the inherent aerodynamic qualities of the sailplane (e.g. buffeting) or by a device that will give clearly distinguishable indications.
- (c) The stall warning must begin:
 - (1) at a speed between $1.05 V_{S1}$ and $1.1 V_{S1}$, or
 - (2) between 2 and 5 seconds before the stall occurs when longitudinal control is moved at a pace corresponding to approximately 2 km/h per second rate of reduction of speed and must continue until the stall occurs.
- (d) Compliance with 22.207(a) through (c) is not required for a sailplane, a self-launching powered sailplane with the engine stopped, or a self-sustaining powered sailplane with the engine stopped or running if the following are met with air brakes, wing-flaps and landing gear in any normal position:
 - (1) recovery from a stall is prompt in both straight and turning flight;
 - (2) when a stall occurs from straight flight:
 - (i) it is possible to produce and correct roll by using the ailerons, the rudder being held neutral; and
 - (ii) no appreciable wingdropping occurs when both ailerons and rudder are held natural;
 - (3) when a stall occurs in a coordinated 45° banked turn, any subsequent rolling or yawing motion is not rapid and is readily controllable.

AMC 22.207(b) Stall warning*ED Decision 2003/13/RM*

A visual stall warning alone is not acceptable.

SPINNING

CS 22.221 General

ED Decision 2003/13/RM

- (a) Compliance with the following requirements must be shown in all configurations and, for a powered sailplane, with the engine idling.

For sailplanes equipped to carry water ballast, the demonstrations of sub-paragraphs (b) to (g) must also be made for the most critical water ballast asymmetry that might occur due to any single malfunction or due to lateral accelerations during a spin.

- (b) The sailplane must be able to recover from spins of at least five turns or such lesser number at which the spin changes into a spiral dive, by applying the controls in a manner normal for recovery and without exceeding either the limiting air-speed nor the limiting positive manoeuvring load factor for the sailplane. Tests must be conducted with wing-flaps and airbrakes neutral (see [AMC 22.335](#)) and with:

- (1) controls held in the position normal for spins;
- (2) ailerons and rudder used in opposite directions;
- (3) ailerons applied in the direction of rotation.

In addition and where applicable, tests must be conducted in critical combinations of airbrake extension, wing-flap deflection, waterballast including trim water-ballast and with the powerplant extended or retracted.

For wing-flap positions for which a V_{FE} limitation is established, the flap position may be adjusted during recovery after the auto-rotation has stopped. (See [AMC 22.221\(b\)](#))

- (c) A sailplane, in the configurations certificated for intentional spinning, must be able to recover from any point in a spin as defined in [CS 22.221\(b\)](#) in not more than one additional turn. In those configurations not approved for intentional spinning, sub-paragraph (d) must be applied. (See [AMC 22.221\(c\), \(d\), \(e\) and \(f\)](#))
- (d) A sailplane in the configurations not certificated for intentional spinning, must still be able to recover from a spin as defined in [CS 22.221\(b\)](#) in not more than one and a half additional turns.
- (e) In addition, any sailplane must be able to recover from a one turn spin in any configuration in not more than one additional turn.
- (f) The loss of altitude from the point at which recovery is initiated to the point at which horizontal flight is first regained must be determined in all of the above mentioned cases.
- (g) It must be impossible to obtain uncontrollable spins with any use of the controls.

AMC 22.221(b) Spinning

ED Decision 2003/13/RM

General

It will normally be sufficient to conduct a number of spins of about two turns in each of the conditions of [CS 22.221\(b\)](#) and subsequently to conduct spins of five turns in the most adverse cases.

AMC 22.221(c),(d),(e) and (f) Spinning

ED Decision 2003/13/RM

General

The standard procedure to recover from a spin is as follows:

Where applicable, close throttle.

Sequentially:

- (1) Check ailerons neutral.
- (2) Apply rudder opposite to the direction of the spin.
- (3) Ease the control column forward until rotation ceases.
- (4) Centralise rudder and ease out of the ensuing dive.

CS 22.223 Spiral dive characteristics

ED Decision 2003/13/RM

If there is any tendency for the spin to turn into a spiral dive the stage at which this tendency occurs, must be determined. It must be possible to recover from the condition without exceeding either the limiting air speed or the limiting positive manoeuvring factor for the sailplane. Compliance with this requirement must be shown without the use of air brakes.

GROUND HANDLING CHARACTERISTICS

CS 22.233 Directional stability and control

ED Decision 2003/13/RM

- (a) With cross-wind components not less than $0.2 V_{S0}$ or 15 km/h, whichever is the greater, there must be no uncontrollable ground-loop tendency at any speed at which the powered sailplane may be expected to be operated on the ground.
- (b) The powered sailplane must have adequate directional control during taxiing.

MISCELLANEOUS FLIGHT REQUIREMENTS

CS 22.251 Vibration and buffeting

ED Decision 2003/13/RM

Each part of the sailplane must be free from excessive vibration at all speeds up to at least V_{DF} . In addition, there must be no buffeting, in any normal flight condition including the use of air brakes, severe enough to interfere with the satisfactory control of the sailplane, cause excessive fatigue to the crew, or result in structural damage. Stall warning buffeting within these limits is allowable. In the case of a powered sailplane this requirement must be met with the engine running at all allowable powers.

CS 22.255 Aerobatic manoeuvres

ED Decision 2003/13/RM

- (a) Each Aerobatic and Utility Category sailplane must be able to perform safely the aerobatic manoeuvres for which certification is requested.
- (b) It must be shown that aerobatic manoeuvres can be carried out with adequate margins between the speeds and accelerations attained therein and the proof strength and design speed of the sailplane.
- (c) When determining the flight characteristics, account must be taken of the possibility of exceeding the recommended entry speeds for the manoeuvres and errors which are likely to be made by the pilot while being trained for aerobatic manoeuvres.
- (d) During the flight tests it is not permitted to use any means (e.g. air brakes, wing-flaps) to restrict the speed in aerobatic manoeuvres.
- (e) The recommended entry speed and where appropriate, the maximum acceleration must be determined for each manoeuvre approved.

AMC 22.255(a) Aerobatic manoeuvres

ED Decision 2003/13/RM

In the case of a powered sailplane this applies with the engine being operated in an appropriate manner.

SUBPART C — STRUCTURE

GENERAL

CS 22.301 Loads

ED Decision 2003/13/RM

- (a) Strength requirements are specified in terms of limit loads (the maximum loads to be expected in service) and ultimate loads (limit loads multiplied by prescribed factors of safety). Unless otherwise provided, prescribed loads are limit loads.
- (b) Unless otherwise provided, the air and ground loads must be placed in equilibrium with inertia forces, considering each item of mass in the sailplane. These loads must be distributed so as to represent actual conditions or a conservative approximation to them.
- (c) If deflections under load would significantly change the distribution of external or internal loads, this redistribution must be taken into account.

CS 22.303 Factor of safety

ED Decision 2003/13/RM

Unless otherwise provided, a factor of safety of 1.5 must be used.

CS 22.305 Strength and deformation

ED Decision 2003/13/RM

- (a) The structure must be able to support limit loads without permanent deformation. At any load up to limit loads, the deformation may not interfere with safe operation. This applies in particular to the control system.
- (b) The structure must be able to support ultimate loads without failure for at least three seconds. However, when proof of strength is shown by dynamic tests simulating actual load conditions, the three second limit does not apply.

CS 22.307 Proof of structure

ED Decision 2003/13/RM

- (a) Compliance with the strength and deformation requirements of [CS 22.305](#) must be shown for each critical load condition. Structural analysis may be used only if the structure conforms to those for which experience has shown this method to be reliable. In other cases, substantiating load tests must be made.
- (b) Certain parts of the structure must be tested as specified in Subpart D.

AMC 22.307(a) Proof of structure

ED Decision 2003/13/RM

- (1) Substantiating load tests made in accordance with [CS 22.307\(a\)](#) should normally be taken to ultimate design load.
- (2) The results obtained from strength tests should be so corrected for departures from the mechanical properties and dimensions assumed in the design calculations as to establish that the possibility of any structure having a strength less than the design value, owing to material and dimensional variation, is extremely remote.

FLIGHT LOADS

CS 22.321 General

ED Decision 2003/13/RM

- (a) Flight load factors represent the ratio of the aerodynamic force component (acting normal to the flight path of the sailplane) to the weight of the sailplane. A positive flight load factor is one in which the aerodynamic force acts upward, with respect to the sailplane.
- (b) Compliance with the flight load requirements of this Subpart must be shown:
 - (1) at each critical altitude within the range in which the sailplane may be expected to operate; and
 - (2) at each practicable combination of weight and disposable load.

AMC 22.321(b) Flight loads

ED Decision 2003/13/RM

General

For sailplanes altitude is not normally critical for flight loads; for powered sailplanes propeller torque and thrust are normally greatest at sea-level.

CS 22.331 Symmetrical flight conditions

ED Decision 2003/13/RM

- (a) The appropriate balancing horizontal tail load must be accounted for in a rational or conservative manner when determining the wing loads and linear inertia loads corresponding to any of the symmetrical flight conditions specified in [CS 22.333](#) through [22.345](#).
- (b) The incremental horizontal tail loads due to manoeuvring and gusts must be reacted by the angular inertia of the sailplane in a rational or conservative manner.
- (c) In computing the loads arising in the prescribed conditions, the angle of attack is assumed to be changed suddenly without loss of flight speed until the prescribed load factor is attained. Angular accelerations may be disregarded.
- (d) Aerodynamic data required for the establishment of the loading conditions must be verified by tests, calculations or by conservative estimation.
 - (1) In the absence of better information the maximum negative lift coefficient in the normal configuration may be taken as -0.8
 - (2) If the pitching moment coefficient C_{m0} is less than ± 0.025 , a coefficient of at least -0.025 must be used for the wing and horizontal tail.

CS 22.333 Flight envelope

ED Decision 2003/13/RM

- (a) *General.* Compliance with the strength requirements of this Subpart must be shown at any combination of air speed and load factor on and within the boundaries of the flight envelopes specified by the manoeuvring and gust criteria of sub-paragraphs (b) and (c) of this paragraph respectively.
- (b) *Manoeuvring envelope.* Wing-flaps in the en-route setting, air brakes closed. (See Figure 1.)

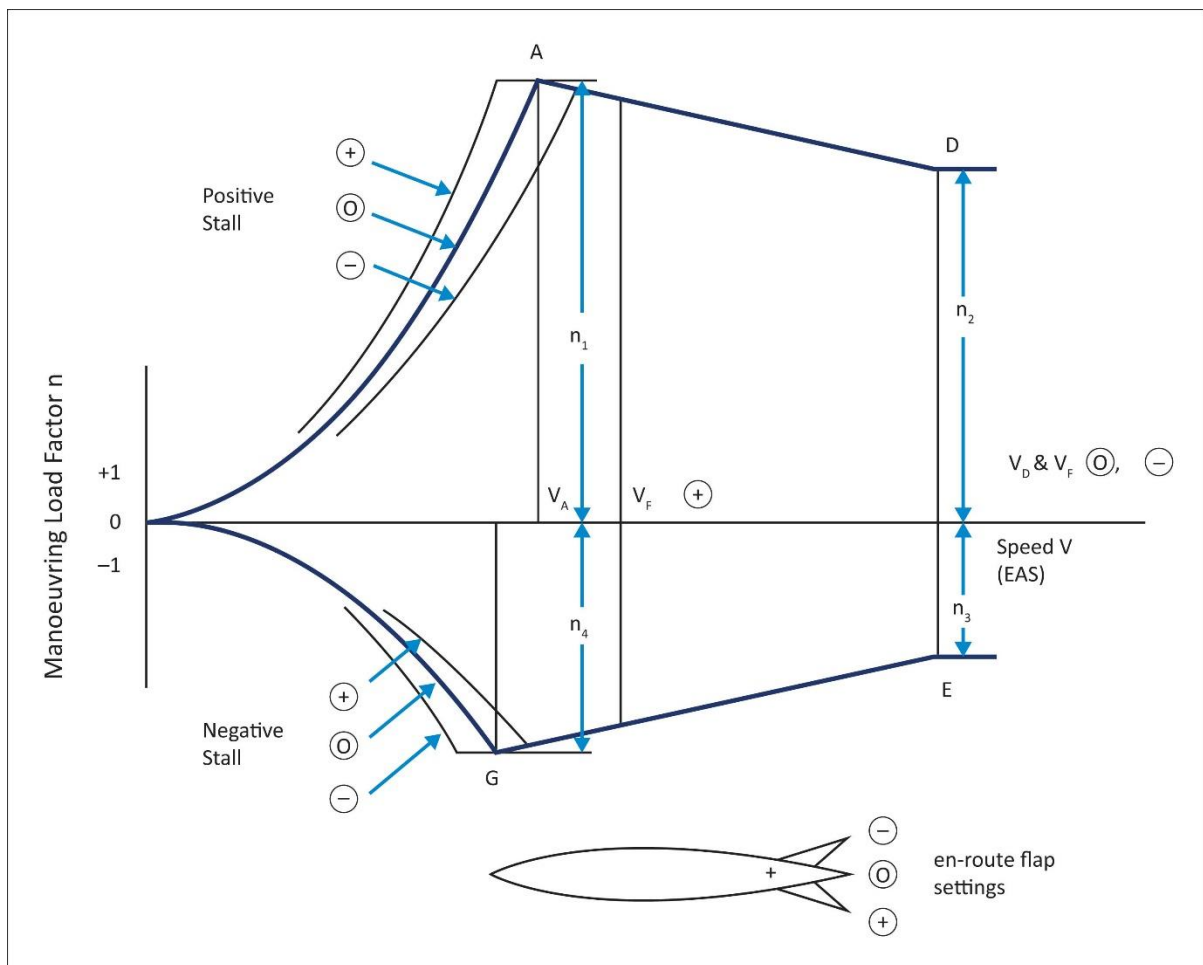

Figure 1 MANOEUVRING ENVELOPE

(c) *Gust envelope.* Wing-flaps in the enroute setting. (See Figure 2.)

- (1) At the design gust speed V_B , the sailplane must be capable of withstanding positive (up) and negative (down) gusts of 15 m/s acting normal to the flight path.
- (2) At the design maximum speed V_D , the sailplane must be capable of withstanding positive (up) and negative (down) gusts of 7.5 m/s acting normal to the flight path.

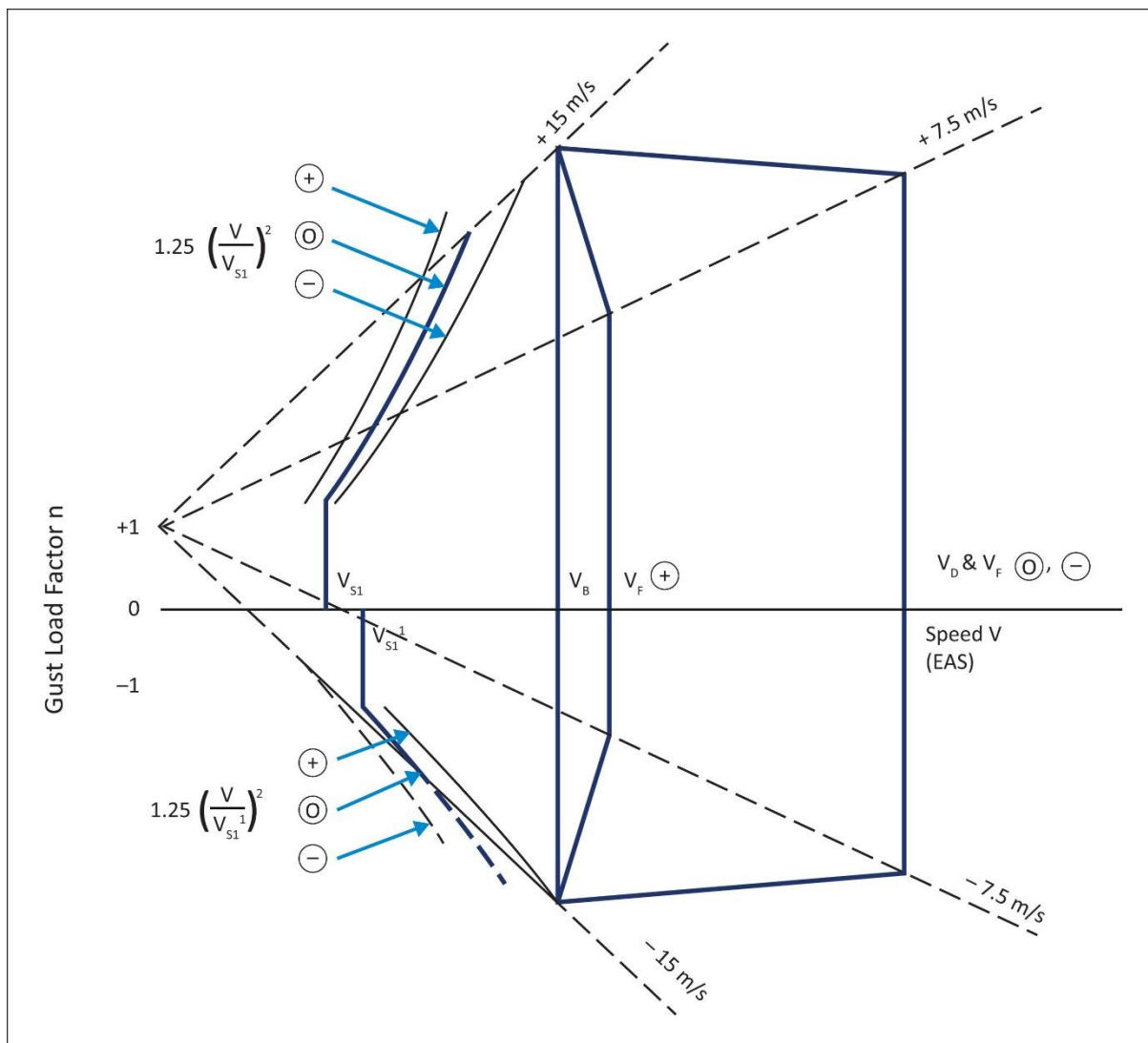

Figure 2 GUST ENVELOPE

CS 22.335 Design air speeds

ED Decision 2003/13/RM

The selected design air speeds are equivalent air speeds (EAS):

- (a) Design manoeuvring speed V_A

$$V_A = V_{S1} \sqrt{n_1}$$

where:

V_{S1} = estimated stalling speed at design maximum weight with wing flaps neutral and air brakes retracted

- (b) Design flap speed, V_F

(1) For each landing setting, V_F must not be less than the greater of:

- (i) $1.4 V_{S1}$, where V_{S1} is the computed stalling speed with wing-flaps neutral at the maximum weight.

- (ii) $2.0 V_{SF}$, where V_{SF} is the computed stalling speed with wing-flaps fully extended at the maximum weight.
- (2) For each positive en-route setting, V_F must not be less than the greater of:
 - (i) $2.7 V_{S1}$, where V_{S1} is the computed stalling speed at design maximum weight with wing flaps in the particular positive en-route setting.
 - (ii) $1.05 V_A$, where V_A is determined in accordance with sub-paragraph (a) of this paragraph, i.e. for wing-flaps neutral.
- (3) For all other settings, V_F must equal V_D .
- (c) *Design Gust Speed V_B* . V_B must not be less than V_A .
- (d) *Design Aerotow Speed V_T* . V_T must not be less than 125 km/h.
- (e) *Design Winch-launching Speed V_W* . V_W must not be less than 110 km/h.
- (f) *Design Maximum Speed V_D* . The design maximum speed may be chosen by the applicant but must not be lower than:

$$V_D = 18 \sqrt[3]{\left(\frac{W}{S}\right) \left(\frac{1}{Cd_{min}}\right)} \text{ (km/h) for sailplanes of Category U}$$

$$V_D = 3.5 \left(\frac{W}{S}\right) + 200 \text{ (km/h) for sailplanes of Category A}$$

where:

$\frac{W}{S}$ = Wing loading (daN/m²) at design

Cd_{min} = The lowest possible drag coefficient of the sailplane

For a powered sailplane, V_D must also not be lower than $1.35 V_H$.

AMC 22.335 Design air speeds

ED Decision 2003/13/RM

- (1) For flaps, the controls for which are intended to be operated in both high and low speed flight, the term ‘wing-flaps neutral’ in [CS 22.335\(a\)](#) and [CS 22.335\(b\)](#) is defined (unless a recognised aerofoil profile is adopted which thus defines the neutral position) as that wing-flap setting which results when one third of the total range of en-route wing-flap settings is subtracted from the most negative setting.
- (2) For flaps, the controls for which are intended to be operated during low speed flight only, i.e. slotted flaps, split flaps and other flaps where extension is conventional and only in the positive direction, ‘wing-flaps neutral’ is the retracted or most-upwardly-deflected setting.

CS 22.337 Limit manoeuvring load factors

ED Decision 2003/13/RM

The limit manoeuvring load factors on the V_n diagram (see Figure 1) must have at least the following values:

Category	U	A
n ₁	+5.3	+7.0
n ₂	+4.0	+7.0
n ₃	-1.5	-5.0

Category	U	A
n4	-2.65	-5.0

CS 22.341 Gust load factors

ED Decision 2003/13/RM

(a) In the absence of a more rational analysis, the gust load factors must be computed as follows:

$$n = 1 \pm \left[\frac{\left(\frac{k}{2}\right) \rho_0 UVa}{\left(\frac{mg}{S}\right)} \right]$$

where:

ρ_0 = density of air at sea-level (kg/m³)

U = gust velocity (m/s)

V = equivalent air speed (m/s)

a = slope of wing lift curve per radian

m = mass of the sailplane (kg)

G = acceleration due to gravity (m/s²)

S = design wing area (m²)

k = gust alleviation factor calculated from the following formula:

$$k = \frac{0.88\mu}{5.3+\mu} \text{ where:}$$

$$\mu = \frac{2\frac{m}{S}}{\rho l m a} \text{ (non-dimensional sailplane mass ratio)}$$

where:

ρ = density of air (kg/m³) at the altitude considered

1m = mean geometric chord of wing (m)

(b) The value of n calculated from the expression given above need not exceed:

$$n = 1.25 \left(\frac{V}{V_{S1}} \right)^2$$

CS 22.345 Loads with air brakes and wing-flaps extended

ED Decision 2003/13/RM

(a) *Loads with air brakes extended*

(1) The sailplane structure including airbrake system, must be capable of withstanding the most unfavourable combination of the following parameters:

Equivalent Air speed	VD (EAS)
Air brakes	from the retracted to the fully extended position
Manoeuvring load factor	from -1.5 to 3.5

- (2) The horizontal tail load is assumed to correspond to the static condition of equilibrium.
 - (3) In determining the spanwise load distribution, changes in this distribution due to the presence of the air brakes must be accounted for.
- (b) *Load with wing-flaps extended.* If wing-flaps are installed, the sailplane must be assumed to be subjected to manoeuvres and gusts as follows:
- (1) With wing-flaps in all landing settings, at speeds up to V_F :
 - (i) manoeuvring up to a positive limit load factor of 4.0;
 - (ii) positive and negative gusts of 7.5 m/s acting normal to the flight path.
 - (2) With wing-flap positions from the most positive en-route setting to the most negative setting, the manoeuvring conditions of [CS 22.333\(b\)](#) and the gust conditions of [CS 22.333\(c\)](#), except that the following need not be considered:
 - (i) speeds greater than the V_F appropriate to the wing-flap setting;
 - (ii) manoeuvring load factors corresponding to points above the line AD or below the line GE of Figure 1.
- (c) *Speed limiting flaps.* If wing-flaps are to be used as a drag-increasing device for the purpose of speed limitation (air-brake) conditions specified in [CS 22.345\(a\)](#) must be met for all wing-flap positions.
- (d) When an automatic wing-flap load limiting device is used, the sailplane must be designed for the critical combination of air speed and wing-flap position allowed by that device.

CS 22.347 Unsymmetrical flight conditions

ED Decision 2003/13/RM

The sailplane is assumed to be subjected to the unsymmetrical flight conditions of [CS 22.349](#) and [CS 22.351](#). Unbalanced aerodynamic moments about the c.g. must be reacted in a rational or conservative manner, considering the principal masses furnishing the reacting inertia forces.

AMC 22.347 Unsymmetrical flight conditions

ED Decision 2003/13/RM

The sailplane is assumed to maintain its attitude after the control surfaces have been activated to initiate roll or yaw until the resulting incremental loads have reached their highest value.

CS 22.349 Rolling conditions

ED Decision 2003/13/RM

The sailplane must be designed for the rolling loads resulting from the aileron deflections and speeds specified in [CS 22.455](#) in combination with a load factor of at least two-thirds of the positive manoeuvring load factors prescribed in [CS 22.337](#).

CS 22.351 Yawing conditions

ED Decision 2003/13/RM

The sailplane must be designed for yawing loads on the vertical tail surface specified in [CS 22.441](#) and [CS 22.443](#).

CS 22.361 Engine torque

ED Decision 2003/13/RM

- (a) The engine mount and its supporting structure must be designed for the effects of:
- (1) the limit torque corresponding to take-off power and propeller speed, acting simultaneously with 75% of the limit loads from flight condition A of [CS 22.333\(b\)](#);
 - (2) the limit torque corresponding to the maximum continuous power and propeller speed, acting simultaneously with the limit loads from flight condition A of [CS 22.333\(b\)](#).
- (b) For reciprocating engines the limit torque to be accounted for in [CS 22.361\(a\)](#) is obtained by multiplying the mean torque by one of the following factors:
- (1) 1.33 for engines with 5 or more cylinders;
 - (2) 2 for engines with 4 cylinders;
 - (3) 3 for engines with 3 cylinders;
 - (4) 4 for engines with 2 cylinders.

CS 22.363 Side load on engine mount

ED Decision 2003/13/RM

- (a) The engine mount and its supporting structure must be designed for a limit load factor in a lateral direction, for the side load on the engine mount, of not less than one-third of the limit load factor for flight condition A (1/3 n₁).
- (b) The side load prescribed in (a) may be assumed to be independent of other flight conditions.

CS 22.371 Gyroscopic Loads

ED Decision 2003/13/RM

For powered sailplanes of airworthiness Category A, the engine mount and its supporting structure must be designed for gyroscopic loads resulting from maximum continuous r.p.m.

CS 22.375 Winglets

ED Decision 2003/13/RM

- (a) When winglets are installed the sailplane must be designed for -
- (1) The side loads due to maximum sideslip angle of the winglet at V_A;
 - (2) Loads resulting from gusts acting perpendicularly to the surface of the winglet at V_B and V_D;
 - (3) Mutual interaction effects of winglets and wing on aerodynamic loads;
 - (4) Hand forces on the winglets; and
 - (5) Loads due to wingtip landing as specified in [CS 22.501](#), if the winglet can touch the ground. (See [AMC 22.375\(a\)](#))
- (b) In the absence of more rational analysis the loads must be computed as follows:
- (1) The lift at the winglets due to sideslip at V_A -

$$L_{W_m} = 1.25 C_{L_{max}} S_W \frac{\rho_0}{2} V_A^2$$

where:

$C_{L_{max}}$ = maximum lift coefficient of winglet profile

S_W = area of winglet

- (2) The lift at the winglets due to lateral gust at V_B and V_D –

$$L_{W_g} = a_W S_W \frac{\rho_0}{2} V U k$$

where:

U = lateral gust velocity at the values as described in [CS 22.333\(c\)](#)

a_W = slope of winglet lift curve per radian

k = Gust alleviation factor as defined in [CS 22.443\(b\)](#)

The above-described load L_{W_g} need not exceed the value

$$L_{W_{max}} = 1.25 C_{L_{max}} S_W \frac{\rho_0}{2} V_{max}^2$$

- (3) Hand forces of 15 daN must be assumed to act at the tip of the winglet -
- (i) In horizontal inboard and outboard direction parallel to the spanwise axis of the wing; and
 - (ii) In horizontal forward and backward direction parallel to the longitudinal axis of the fuselage.

In addition, the rigging loads as specified in [CS 22.591](#) must be applied if the winglet plane is not normal to the plane of the wing.

AMC 22.375(a) Winglets

ED Decision 2003/13/RM

For the wing the interactive effects between the winglets and the wing should be taken into account, as there are:

- (1) Changes in wing lift distribution;
- (2) Additional bending and torsion moments at the attachment point of the winglet due to aerodynamic and mass loads on the winglet;
- (3) Effects of inertia; and
- (4) Effects of drag on wing torsion.

CONTROL SURFACES AND SYSTEMS

CS 22.395 Control system loads

ED Decision 2003/13/RM

- (a) Each flight control system, including stops, and its supporting structure must be designed for the loads corresponding to at least 125% of the computed hinge moments of the movable control surfaces in the conditions prescribed in [CS 22.415](#) through [CS 22.455](#). In computing the hinge moments reliable aerodynamic data must be used. The effects of tabs must be taken into account. In no case must the loads in any part of the system be less than those resulting from the application of 60% of the pilot efforts specified in [CS 22.397\(a\)](#).
- (b) Pilot forces used for design are assumed to act at the appropriate control grips or pads as they would in flight, and to be reacted at the attachments of the control system to the control surface horns.

CS 22.397 Loads resulting from limit pilot forces

ED Decision 2003/13/RM

- (a) In addition to [CS 22.395\(a\)](#) the control systems for the direct control of the sailplane about its longitudinal, lateral, or yaw-axis (main control system) and other control systems affecting flight behaviour and supporting points must be designed to withstand as far as to the stops (these included) limit loads arising from the following pilot forces:

Control	Pilot force daN	Method of force application assuming single lever control systems
Elevator	35	Push and pull handgrip of control stick
Ailerons	20	Move handgrip of control stick sideways
Rudder	90	Apply forward pressure on one rudder pedal
Airbrakes Spoilers Wing-flaps	35	Push and pull handgrip of control lever
Towing cable release	35	Pull control handle

- (b) The rudder control system must be designed to a load of 100 daN per pedal acting simultaneously on both pedals in forward direction.

CS 22.399 Dual control systems

ED Decision 2003/13/RM

Dual control systems must be designed for:

- (a) the pilots acting together in the same direction; and
- (b) the pilots acting in opposition, each pilot applying 0.75 times the load specified in [CS 22.397\(a\)](#).

CS 22.405 Secondary control systems

ED Decision 2003/13/RM

Secondary control systems such as those for landing gear retraction or extension, trim control, etc., must be designed for supporting the maximum forces that a pilot is likely to apply to those controls.

AMC 22.405 Secondary control systems

ED Decision 2003/13/RM

Hand and foot loads assumed for design should not be less than the following:

- (1) Hand loads on small hand-wheels, cranks, etc., applied by finger or wrist-force: P = 15 daN.
- (2) Hand loads on levers and hand-wheels applied by the force of an unsupported arm without making use of the body weight: P = 35 daN.
- (3) Hand loads on levers and hand-grips applied by the force of a supported arm or by making use of the body weight: P = 60 daN.
- (4) Foot loads applied by the pilot when sitting with his back supported (e.g. toe-brake operating loads): P = 75 daN.

CS 22.411 Control system stiffness and stretch

ED Decision 2003/13/RM

- (a) The amount of movement available to the pilot of any aerodynamic control surface may not, in any condition of flight, be excessively reduced by elastic stretch of the control circuits.
If there are cables in the system and tension can be adjusted, the minimum value must be used for demonstrating compliance with all appropriate requirements.
- (b) For cable operated systems, the allowable rigging tension in the cables must be established, taking into consideration the variations in temperature (see [CS 22.689](#)) which may occur.

AMC 22.411(a) Control system stiffness and stretch

ED Decision 2003/13/RM

Control systems will normally be accepted as complying with paragraph [CS 22.411\(a\)](#) if they meet the following:

Under the application of the loads prescribed in [CS 22.395](#), no part of the control system should stretch or shorten by more than 25%. The stretch percentage is defined as $D_e = 100 a/A$ where:

- a = comparable movement of the cockpit controls when the pilot effort is resisted by fixing the control surfaces at their zero settings
- A = available positive or negative movement of the cockpit controls (measured from their neutral position) when the control surface and the control mechanism are free.

However, stretch or shortening greater than 25% may be acceptable provided special attention is given to compliance with [CS 22.143](#) and [CS 22.629](#) in these conditions.

CS 22.415 Ground gust conditions

ED Decision 2003/13/RM

The control system from the control surfaces to the stops, or when installed, the arresting devices must be designed for limit loads corresponding to hinge moments calculated from the expression:

$$M_R = k l_R S_R q$$

where :

M_R = limit hinge moment

l_R = mean chord of control surface aft of hinge line

S_R = area of control surface aft of hinge line

q = dynamic pressure corresponding to an air speed of 100 km/h

k = limit hinge moment factor due to ground gust, taken from the following table:

Control Surface	k	Remarks
Aileron	± 0.75	Control column secured in mid-position
	± 0.50	Ailerons at full travel + moment at the one, – moment at the other aileron
Elevator	± 0.75	Elevator fully up (–) or fully down (+) or in the position in which it can be locked
Rudder	± 0.75	Rudder at full travel right or left, or locked in neutral

HORIZONTAL TAIL SURFACES

CS 22.421 Balancing loads

ED Decision 2003/13/RM

- (a) A horizontal tail balancing load is the load necessary to maintain equilibrium in any specified flight condition with no pitching acceleration.
- (b) The horizontal tail must be designed for the balancing loads occurring at any point of the limit manoeuvring envelope and in the air-brake and wing-flap positions as specified in [CS 22.333](#) and [CS 22.345](#).

CS 22.423 Manoeuvring loads

ED Decision 2003/13/RM

The horizontal tail must be designed for the most severe loads likely to occur in pilot-induced pitching manoeuvres, at all speeds up to V_D .

AMC 22.423 Manoeuvring loads

ED Decision 2003/13/RM

Method I – The loads should be calculated for instantaneous deflection of the elevator, the following cases being considered:

- (a) speed V_A , maximum upward deflection;
- (b) speed V_A , maximum downward deflection;
- (c) speed V_D , one-third maximum upward deflection;
- (d) speed V_D , one-third maximum downward deflection.

The following assumptions should be made:

- (1) The sailplane is initially in level flight, and its attitude and air speed do not change.
- (2) The loads are balanced by inertia forces.

The sailplanes of Category A, initial conditions of both erect and inverted flight should be considered.

Method II – The loads should be calculated for instantaneous deflection of the elevator such as to cause the normal acceleration to change from an initial value to a final value, the following cases being considered (see Figure 3).

Category U and A:			
Speed	Initial Condition	Final Condition	Load Factor Increment
V_A	A_1	A	$n_1 - 1$
	A	A_1	$1 - n_1$
	A_1	G	$n_4 - 1$
	G	A_1	$1 - n_4$
V_D	D_1	D	$n_2 - 1$
	D	D_1	$1 - n_2$
	D_1	E	$n_3 - 1$
	E	D_1	$1 - n_3$

Category A – Additional cases:			
Speed	Initial Condition	Final Condition	Load Factor Increment
V _A	A ₋₁	A	n ₁ + 1
	A	A ₋₁	-(1 + n ₁)
	A ₋₁	G	n ₄ + 1
	G	A ₋₁	-(1 + n ₄)
V _D	D ₋₁	D	n ₂ + 1
	D	D ₋₁	-(1 + n ₂)
	D ₋₁	E	n ₃ + 1
	E	D ₋₁	-(1 + n ₃)

For the purpose of this [AMC 22.423](#) the difference in air speed between V_A and the value corresponding to point G on the manoeuvring envelope should be ignored.

The following assumptions should be made:

- (1) the sailplane is initially in level flight, and its altitude and air speed do not change;
- (2) the loads are balanced by inertia forces;
- (3) The aerodynamic tail load increment is given by

$$\Delta P = \Delta n \, m g \left[\frac{x_{cg}}{l_t} - \frac{S_t}{S} \frac{a_h}{a} \left(1 - \frac{d\varepsilon}{d\alpha} \right) - \frac{\rho_o}{2} \left(\frac{S_t a_h l_t}{m} \right) \right]$$

where:

ΔP = horizontal tail load increment, positive upwards (N)

Δn = load factor increment

m = mass of the sailplane (kg)

g = acceleration due to gravity (m/s²)

x_{cg} = longitudinal distance of sailplane c.g. aft of aerodynamic centre of sailplane less horizontal tail (m)

S_t = horizontal tail area (m²)

a_h = slope of horizontal tail lift curve per radian

$\frac{d\varepsilon}{d\alpha}$ = rate of change of downwash angle with angle of attack

ρ_o = density of air at sea-level (kg/m³)

l_t = tail arm (m)

S = wing area (m²)

a = slope of wing lift curve per radian

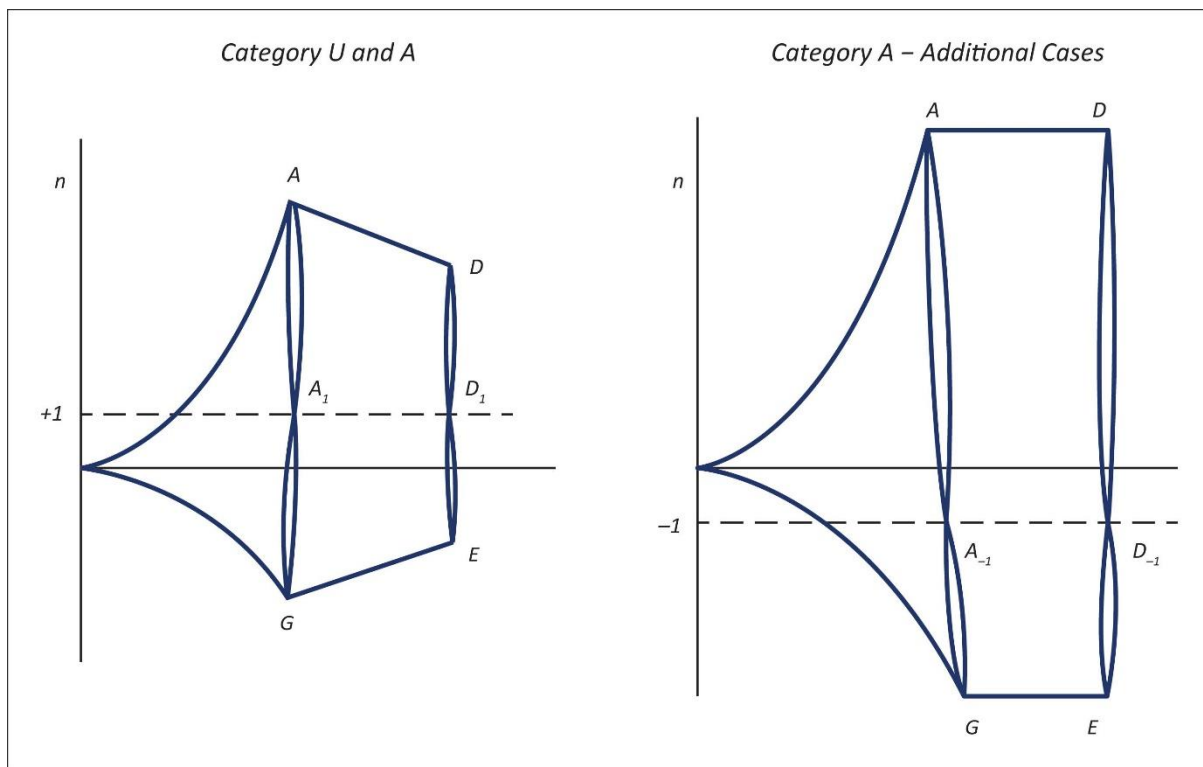

Figure 3 PITCHING MANOEUVRES

CS 22.425 Gust loads

ED Decision 2003/13/RM

In the absence of a more rational analysis, the horizontal tail loads must be computed as follows:

$$P = P_o + \frac{P_o}{2} S_t a_h U kH V \left(1 - \frac{d\varepsilon}{d\alpha} \right)$$

where:

P = horizontal tail load (N)

P_o = horizontal tail balancing load acting on the horizontal tail before the appearance of the gust (N)

ρ_o = density of air at sea-level (kg/m³)

S_t = area of horizontal tail (m²)

a_h = slope of horizontal tail lift curve per radian

U = gust speed (m/s)

kH = gust factor. In the absence of a rational analysis the same value may be taken as for the wing.

V = speed of flight (m/s)

$\frac{d\varepsilon}{d\alpha}$ = rate of change of downwash angle with wing angle of attack

CS 22.427 Unsymmetrical loads for powered sailplanes

ED Decision 2003/13/RM

The slipstream effect on fixed surfaces and on rudder loads must be accounted for if such loading is to be expected.

VERTICAL TAIL SURFACES

CS 22.441 Manoeuvring loads

ED Decision 2003/13/RM

The vertical tail surfaces must be designed for manoeuvring loads imposed by the following conditions:

- (a) At speed the greater of V_A and V_T , full deflection of the rudder.
- (b) At speed V_D , one-third of full deflection of the rudder.

AMC 22.441 Vertical tail surfaces

ED Decision 2003/13/RM

Manoeuvring load

For sailplanes where the horizontal tail is supported by the vertical tail, the tail surfaces and their supporting structure including the rear portion of the fuselage should be designed to withstand the prescribed loadings on the vertical tail and the rolling moment induced by the horizontal tail acting in the same direction.

For T-tails in the absence of a more rational analysis, the rolling moment induced by side-slip or deflection of the vertical rudder may be computed as follows:

$$M_r = 0.4 S_t \frac{\rho_o}{2} \beta V^2 b_v$$

where:

M_r = induced rolling moment at horizontal tail (Nm)

b_v = span of vertical tail, measured from the bottom of the fuselage

β = side-slip angle (radian)

This formula is only valid for vertical tail aspect ratios between 1 and 1.8 (with span and area measured from the bottom of the fuselage) and horizontal tail with no dihedral and aspect ratio 6 or less. For configurations in excess of these limits more detailed rational analysis will be required.

CS 22.443 Gust loads

ED Decision 2003/13/RM

- (a) Vertical tail surfaces must be designed to withstand lateral gusts to the values described in [CS 22.333\(c\)](#).
- (b) In the absence of a more rational analysis, the gust load must be computed as follows:

$$P_f = a_v S_f \frac{\rho_o}{2} V U k$$

where:

P_f = gust load (N)

a_v = slope of vertical tail lift curve per radian

S_f = area of vertical tail (m²)

ρ_o = density of air at sea-level (kg/m³)

- V = speed of flight (m/s)
 U = gust speed (m/s)
 K = gust factor, should be taken as 1.2

AMC 22.443 Vertical tail surfaces

ED Decision 2003/13/RM

Gust loads

For sailplanes where the horizontal tail is supported by the vertical tail, the tail surfaces and their supporting structure including the rear portion of the fuselage should be designed to withstand the prescribed loadings on the vertical tail and the rolling moment induced by the horizontal tail acting in the same direction.

For T-tails in the absence of a more rational analysis, the rolling moment induced by gust load may be computed as follows:

$$M_r = 0.4 S_t \frac{\rho_o}{2} V U b_v k$$

where:

- M_r = induced rolling moment horizontal tail (Nm)
 b_v = span of vertical tail, measured from the bottom of the fuselage

This formula is only valid for vertical tail aspect ratios between 1 and 1.8 (with span and area measured from the bottom of the fuselage) and horizontal tail with no dihedral and aspect ratio 6 or less. For configurations in excess of these limits more detailed rational analysis will be required.

SUPPLEMENTARY CONDITIONS FOR TAIL SURFACES

CS 22.447 Combined loads on tail surfaces

ED Decision 2003/13/RM

- (a) The unsymmetrical distribution of the balancing load on the horizontal tail which arises in flight conditions A and D of the V-n envelope must be combined with the appropriate manoeuvring load on the vertical surface as specified in [CS 22.441](#) acting in such a direction as to increase the rolling torque.
- (b) 75% for Category U and 100% for Category A of the loads according to [CS 22.423](#) for the horizontal tail and [CS 22.441](#) for the vertical tail must be assumed to be acting simultaneously.

AMC 22.447(a) Combined loads on tail surfaces

ED Decision 2003/13/RM

- (1) In the absence of rational data the unsymmetrical distribution shall be obtained by multiplying the air load on one side of the plane of symmetry by (1+x) and on the other side by (1-x).
- (2) For point A of the V-n envelope the value of x shall be 0.34 and in the case of an aerobatic category sailplane certificated for flick manoeuvres x shall be 0.5. For point D the value of x shall be 0.15.
- (3) The unsymmetrical horizontal tail load must not be combined with the induced rolling moment at the T-tail.

CS 22.449 Additional loads applicable to V-tails*ED Decision 2003/13/RM*

A sailplane with V-tail, must be designed for a gust acting perpendicularly with respect to one of the tail surfaces at speed V_B .

AILERONS

CS 22.455 Ailerons

ED Decision 2003/13/RM

The ailerons must be designed for control loads corresponding to the following conditions:

- (a) at speed the greater of V_A and V_T the full deflection of the aileron; and
- (b) at speed V_D , one-third of the full deflection of the aileron.

GROUND LOADS

CS 22.471 General

ED Decision 2003/13/RM

The limit ground loads specified in this Subpart are considered to be external loads and inertia forces that act upon a sailplane structure. In each specified ground load condition, the external reactions must be placed in equilibrium with the linear and angular inertia forces in a rational or conservative manner.

CS 22.473 Ground load conditions and assumptions

ED Decision 2003/13/RM

- (a) The ground load requirements of this Subpart, must be complied with at the design maximum weight.
- (b) The selected limit vertical inertia load factor at the c.g. of the sailplane for the ground load conditions prescribed in this Subpart
 - (i) may not be less than that which would be obtained when landing with a descent velocity of 1.77 m/s.
 - (ii) may not be less than 3.
- (c) Wing lift balancing the weight of the sailplane may be assumed to exist throughout the landing impact and to act through the c.g. The ground reaction load factor may be equal to the inertia load factor minus one.

CS 22.477 Landing gear Arrangement

ED Decision 2003/13/RM

[CS 22.479](#) through [CS 22.499](#) apply to sailplanes with conventional arrangements of landing gear. For unconventional types it may be necessary to investigate additional landing conditions depending on the arrangement and design of the landing gear units.

AMC 22.477 Landing gear arrangement

ED Decision 2003/13/RM

For the purpose of these requirements landing gears are considered conventional if they consist of:

- (1) A single wheel or twin coaxial wheels at the bottom of the fuselage or two laterally separated single wheels (with or without shock absorbers) located directly, or nearly so, below the c.g. of the sailplane, together with a nose wheel or with auxiliary skids attached to the bottom of the fuselage, one auxiliary skid running from the main wheel (or wheels) forward to the nose and the other running aft to a point approximately below the wing trailing edge. The rear skid may be replaced or supplemented by a suitable tail skid. Both skids may be replaced by suitable reinforcements of the fuselage structure.
- (2) A single elastic main skid at the bottom of the fuselage extending from the nose to a point approximately below the wing trailing edge. This skid may be supplemented by a tail skid or wheel.
- (3) Wing-tip skids

CS 22.479 Level landing condition

ED Decision 2003/13/RM

- (a) For a level landing, the sailplane is assumed to be in the following attitudes:
- (1) For sailplanes with a tail skid and/or wheel, a normal level flight attitude.
 - (2) For sailplanes with nose wheels, attitudes in which –
 - (i) The nose and main wheels contact the ground simultaneously; and (ii) The main wheels contact the ground and the nose wheel is just clear of the ground.
- (b) The main gear vertical load component P_{VM} must be determined to the conditions in [CS 22.725](#).
- (c) The main gear vertical load component P_{VM} must be combined with a rearward acting horizontal component P_H so that the resultant load acts at an angle at 30° with the vertical.
- (d) For sailplanes with nose wheels the vertical load component P_{VN} on the nose wheel in the attitude of sub-paragraph (a)(2)(i) of this paragraph must be computed as follows and must be combined with a rearward acting horizontal component according to sub-paragraph (c) of this paragraph taking into account [CS 22.725\(a\)](#):

$$P_{VN} = 0.8 m g$$

where:

m = mass of the sailplane (kg)

g = acceleration of gravity (m/s^2).

CS 22.481 Tail-down landing conditions

ED Decision 2003/13/RM

For design of tail skid and affected structure and empennage including balancing weight attachment, the tail skid load in a tail down landing (main landing gear free from ground) must be calculated as follows:

$$P = 4 m g \left(\frac{i_y^2}{i_y^2 + L^2} \right)$$

where:

P = tail skid load (N)

m = mass of the sailplane (kg)

g = acceleration of gravity (m/s^2)

i_y = radius of gyration of the sailplane (m)

L = distance between tail skid and sailplane c.g. (m)

AMC 22.481 Tail-down landing conditions

ED Decision 2003/13/RM

Where i_y cannot be determined by more rational means, a value of:

$$i_y = 0.225 L_R$$

may be used:

L_R in this case to be taken as the overall length of the fuselage without rudder.

In designing the tail skid, side loads should be accounted for in addition to the vertical load determined as above.

CS 22.483 One-wheel landing condition

ED Decision 2003/13/RM

If the two wheels of a main landing gear arrangement are laterally separated (see [AMC 22.477\(1\)](#)) the conditions under [CS 22.479\(a\)\(2\), \(b\) and \(c\)](#) must be applied also to each wheel separately taking into account limiting effects of bank. In the absence of a more rational analysis the limit kinetic energy must be computed as follows:

$$A = \frac{1}{2} m_{red} V_V^2$$

where:

$$m_{red} = m \frac{1}{1 + \frac{a^2}{i_x^2}}$$

V_V = rate of descent

m = mass of the sailplane (kg)

a = half the track (m)

i_x = radius of gyration of the sailplane (m)

CS 22.485 Side load conditions

ED Decision 2003/13/RM

A side load acting on one side of the main landing gear (both from right and left) normal to the plane of symmetry at the centre of the contact area of the tyre or skid with the ground, must be assumed. The applied load is equal to $0.3 P_V$ and must be combined with a vertical load of $0.5 P_V$ where P_V is the vertical load determined in accordance with [CS 22.473](#).

CS 22.497 Tail skid impact

ED Decision 2003/13/RM

- (a) Except as provided in (b), if the c.g. of the unloaded sailplane – in side view – is situated behind the ground contact area of the main landing gear, the rear portion of the fuselage, the tail skid and the empennage must be designed to withstand the loads arising when the tail landing gear is raised to its highest possible position, consistent with the main wheel remaining on the ground, and is then released and allowed to fall freely.
- (b) If the c.g. in all loading conditions is situated behind the ground contact area of the main landing gear (a) need not be applied.

CS 22.499 Supplementary conditions for nose wheels

ED Decision 2003/13/RM

In determining the ground loads on the nose wheel and affected supporting structures, and assuming that the shock absorber and tyre are in their static positions, the following conditions must be met:

- (a) For forward loads, the limit force components at the axle must be:
 - (1) A vertical component of 2.25 times the static load on the wheel; and

- (2) A forward component of 0.4 times the vertical component.
- (b) For side loads, the limit force components at ground contact must be:
 - (1) A vertical component of 2.25 times the static load on the wheel; and
 - (2) A side component of 0.7 times the vertical component.

CS 22.501 Wing-tip landing

ED Decision 2003/13/RM

There must be means to ensure that ground loads acting at the wing tips are adequately resisted. A limit load $T = 40 \text{ daN}$ must be assumed to act rearward at the point of contact of one wing-tip with the ground, in a direction parallel to the longitudinal axis of the sailplane, the yawing moment so generated must be balanced by side load R at the tail skid/wheel or nose skid/wheel (see Figure 4).

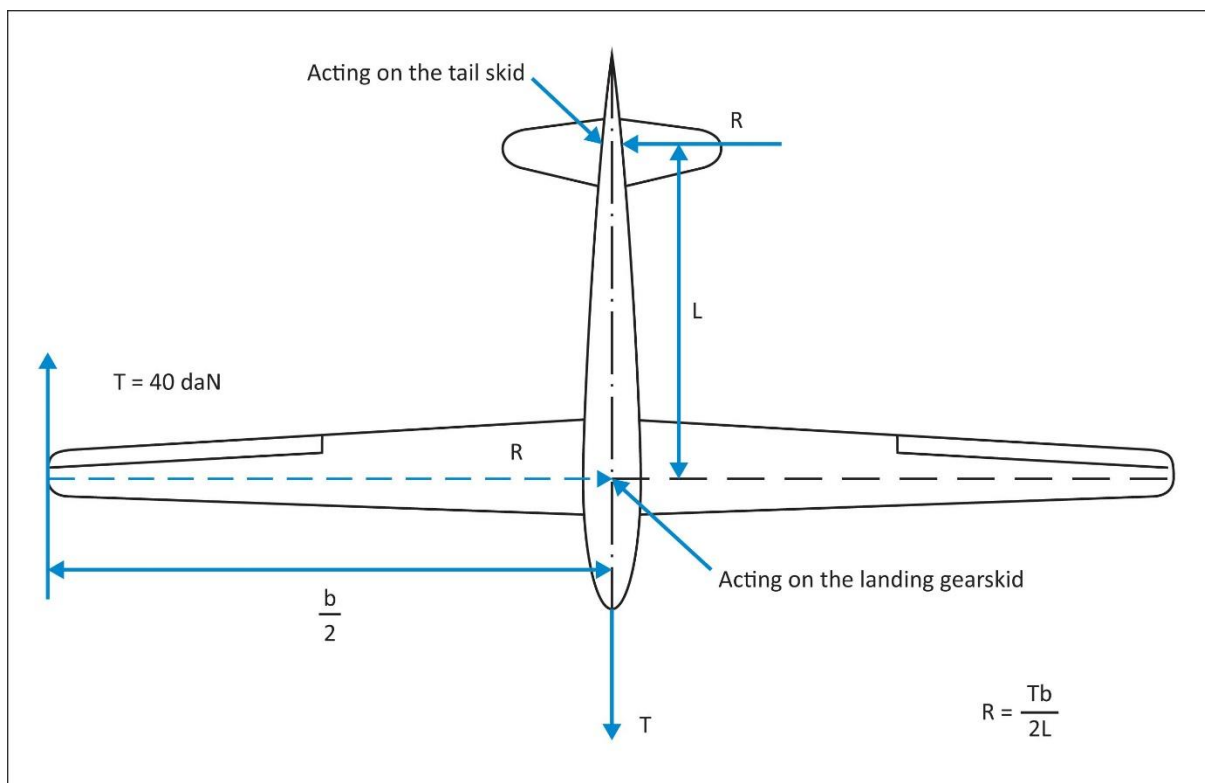

Figure 4 WING-TIP LANDING

EMERGENCY LANDING CONDITIONS

CS 22.561 General

ED Decision 2008/008/R

 (See [AMC 22.561](#))

- (a) The sailplane although it may be damaged in emergency landing conditions must be designed as prescribed in this paragraph to protect each occupant under those conditions.
- (b) The structure must be designed to give each occupant every reasonable chance of escaping serious injury in a crash landing when proper use is made of belts and harnesses provided for in the design, in the following conditions:
 - (1) The occupant experiences, separately, ultimate inertia forces corresponding to the accelerations shown in the following:

Upward	7.5 g
Forward	15.0 g
Sideward	6.0 g
Downward	9.0 g

- (2) An ultimate load of 9 times the weight of the sailplane acting rearwards and upwards at an angle of 45° to the longitudinal axis of the sailplane and sideward at an angle of 5° acts on the forward portion of the fuselage at a suitable point not behind the pedals. (See [AMC 22.561\(b\)\(2\)](#))
- (c) Each sailplane with a retractable landing gear must be designed to protect each occupant in a landing with wheel(s) retracted under the following conditions:
 - (1) a downward ultimate inertia force corresponding to an acceleration of 3 g;
 - (2) a coefficient of friction of 0.5 at the ground.
- (d) Except as provided in [CS 22.787](#), the supporting structure must be designed to restrain, under loads up to those specified in sub-paragraph (b)(1) of this paragraph each item of mass that could injure an occupant if it came loose in a crash landing.
- (e) For a powered sailplane with the engine located behind and above the pilot's seat, an ultimate inertia load of 15 g in the forward direction must be assumed.

[Amdt 22/1]

AMC 22.561 Emergency Landing Conditions - General

ED Decision 2008/008/R

For maximum protection of the occupants in survivable crash landings, the main part of the cockpit, defined in [AMC 22.561\(b\)\(2\)](#), should constitute a safety cell strong enough to comply with paragraph [CS 22.561\(b\)\(2\)](#).

The forward part should be sufficiently weaker for it to yield before the main part, but stiff enough for it to absorb considerable energy in doing so. (ref. 2, 4, 5, 8, 9, 11)

Energy-absorbing seats, seat cushions or seat mountings constitute another means of improving safety by reducing the load on the occupants head and spine in a crash (ref. 1, 3, 10) and /or landing with retracted wheels ([CS 22.561\(c\)](#)).

The wording „give every reasonable chance” expresses the limited possibility to determine the quantitative probability of injuries in the process, which is affected by many random inputs (e.g.: physical weight and height of the occupant, his age, influencing the spinal load resistance, specific characteristics of the particular accident etc.).

The required load level has been chosen partly on medical grounds and partly in consideration of what is currently practicable. The objective is to design a cockpit structure that does not collapse under survivable emergency landing conditions.

Furthermore the sailplane design should consider:

- Maximum energy absorption, and
- Occupant protection against serious injuries, namely injuries of head and spine.

For maximum protection of the foremost part of legs during the front part deformation, the feet should have adequate space to move slightly backwards together, without twisting or rocking.

The conditions specified in this paragraph are considered to be most representative of the wide envelope of possible crash loads and impact directions (ref. 5, 9). However the design should be such that the strength is not unduly sensitive to load direction in pitch or yaw.

Further information about different aspects of the crashworthiness of small aircraft design has been accumulated for small airplanes (ref. 6). Published data and procedures are also applicable for sailplane designs.

Applicable information on dynamic computer modelling contained in (ref. 7) might be used to assess applicability of such methods for sailplanes crashworthiness tasks.

Note: Compliance with the revised [CS 22.561](#) requirements would also assure the adequate structural characteristics for safe ground impact when Sailplane Parachute Rescue System is applied. (ref. 4,12)

References:

- (1) Chandler. R.F.
Injury Criteria Relative to Civil Aircraft Seat and Restraint Human Systems. SAE TP Series No. 851847. (Publication 1985)
- (2) Hansman, R.J., Crawley, E.F., Kampf, K.P.
Experimental Investigation of the Crashworthiness of Scaled Composite Sailplane Fuselages.
Technical Soaring Vol. 14 No 4. ISSN #0744-8996 (1990)
- (3) Segal, A.M., McKenzie, L., Neil, L., Rees, M.
Dynamic Testing of Highly Damped Foam.
Technical Soaring Vol. 19 No 4. ISSN #0744-8996 (1995)
- (4) Róger, W., Conradi, M., Ohnimus, T
Insassensicherheit bei Luftfahrtgerät. Fachhochschule Aachen. Forschungsbericht im Auftrag des Bundesministerium für Verkehr 1996 (Publication December 1996)
- (5) Sperber, M.
Crashworthiness in Glider Cockpits.
OSTIV XXV Congress paper 1997, St Auban

- Untersuchung des Insassenschutzes bei Unfällen mit Segelflugzeugen und Motorsegler
Forschungsauftrag Nr.L-2/93-50112/92, TÜV Rheinland, Köln/Rh. Germany, 1998
- (6) Hurley, T.R., Vandenburg, J.M.
Small Airplane Crashworthiness Design Guide, AGATE-WP3.4-034043-036
Simula Technologies, Phoenix AZ, USA. (Publication April 2002)
- (7) FAA ACE 100
FAA Methodology for Dynamic Seats Certification by Analysis. AC 20 -146, FAA, USA (Publication date 5/19/03)
- (8) Boermans, L., Nicolossi, F., Kubrynski, K.,
Aerodynamic Design of High Performance Sailplane Wing Fuselage Combination. ICAS-98-2, 9,
2 Publication. (Publication 1998)
- (9) Sperber, M. et al.
Energy absorption on landing accidents with sailplanes and powered sailplanes Rep. No. FE-
Nr.L-2/2005-50.0304/2004, TÜV Rheinland, Köln /Rh., Germany, 2007
- (10) Segal, A.M.,
Energy Absorbing Seat Cushions for use in Gliders. Technical Soaring Vol. 32, No 1/2.
ISSN #0744-8996 (2008)
- (11) Röger, W.
Safe and Crashworthy Cockpit
Fachhochschule Aachen, Fachbereich Luft-und Raumfahrttechnik,Germany, 2007
- (12) Röger, W.
Verbesserung der Insassensicherheit bei Segelflugzeugen und Motorsegler durch integrierte
Rettungssysteme, Forschungsauftrag Nr. L-2/90-50091/90, Fachhochschule Aachen, Germany,
1994.

[Amdt 22/1]

AMC 22.561(b)(2) Emergency Landing Conditions

ED Decision 2008/008/R

Compliance with [CS 22.561\(b\)\(2\)](#) can be shown either by static tests or by analysis using methods validated by previous static test evidence from structures of similar design. The analysis should, at minimum, show that ultimate material strength properties and stability limits, such as buckling of the canopy sill, are not exceeded. The weight used when showing compliance to [CS 22.561\(b\)\(2\)](#) should represent the maximum weight derived from [CS 22.25\(a\)\(2\)](#) as far as these weights contribute to the loading of the safety cell.

For conventional (semi-reclined) seating configurations it is sufficient to demonstrate, that the main part of the cockpit, extending at least from the front control pedals (adjusted to the intermediate longitudinal position) to the rearmost headrest mounting or the wing attachment section whichever is further aft, including the harness attachments (ref. 1), meets the requirements of [CS 22.561\(b\)](#).

References:

- (1) Sperber, M.

Restraint Systems in Gliders under Biomechanical Aspects.

Technical Soaring Vol. 19 No 2. ISSN #0744-8996 (1995)

[Amdt 22/1]

TOWING AND LAUNCHING LOADS

CS 22.581 Aerotowing

ED Decision 2003/13/RM

- (a) The sailplane must be initially assumed to be in stabilized level flight at speed V_T with a cable load acting at the launching hook in the following directions:
- (1) horizontally forwards;
 - (2) in plane of symmetry forwards and upwards at an angle of 20° with the horizontal;
 - (3) in plane of symmetry forwards and downwards at an angle of 40° with the horizontal; and
 - (4) horizontally forwards and sideways at an angle of 30° with the plane of symmetry.
- (b) With the sailplane initially assumed to be subjected to the same conditions as specified in [CS 22.581\(a\)](#), the cable load due to surging suddenly increases to Q_{nom} , assuming the use of a textile rope.
- (1) The resulting cable load increment must be balanced by linear and rotational inertia forces. These additional loads must be superimposed on those arising from the conditions of [CS 22.581\(a\)](#).
 - (2) Q_{nom} is the rated ultimate strength of the towing cable (or weak link if employed). For the purpose of these requirements it must be assumed to be not less than 1.3 times the sailplane maximum weight and not less than 500 daN.

CS 22.583 Winch-launching

ED Decision 2003/13/RM

- (a) The sailplane must be initially assumed to be in level flight at speed V_W with a cable load acting at the launching hook in a forward and downward direction at an angle ranging from 0° to 75° with the horizontal.
- (b) The cable load must be determined as the lesser of the following two values:
- (1) $1.2 Q_{nom}$ as defined in [CS 22.581\(b\)](#), or
 - (2) the loads at which equilibrium is achieved, with either:
 - (i) the elevator fully deflected in upward direction, or
 - (ii) the wing at its maximum lift.

A horizontal inertia force may be assumed to complete the equilibrium of horizontal forces.

- (c) In the conditions of [CS 22.583\(a\)](#), a sudden increase of the cable load to the value of $1.2 Q_{nom}$ as defined in [CS 22.581\(b\)](#), is assumed. The resulting incremental loads must be balanced by linear and rotational inertia forces.

CS 22.585 Strength of launching hook attachment

ED Decision 2003/13/RM

- (a) The launching hook attachment must be designed to carry a limit load of $1.5 Q_{nom}$, as defined in [CS 22.581\(b\)](#), acting in the directions specified in [CS 22.581](#) and [CS 22.583](#).

- (b) The launching hook attachment must be designed to carry a limit load equal to the maximum weight of the sailplane, acting at an angle of 90° to the plane of symmetry.

OTHER LOADS

CS 22.591 Rigging and de-rigging loads

ED Decision 2003/13/RM

A rigging limit load of plus and minus twice the wing-tip reaction, determined when either a semi-span wing is simply supported at root and tip or when the complete wing is simply supported at the tips, where this would be representative of the rigging procedure, must be assumed to be applied at the wing tip and reacted by the wing when supported by a reaction and couple at the wing root.

CS 22.593 Hand forces at the horizontal tail surfaces

ED Decision 2003/13/RM

A limit hand force of 3% of the design maximum weight of the sailplane but not less than 15 daN must be assumed to act on either tip of the horizontal tail surface:

- (a) in the vertical direction;
- (b) in the horizontal direction, parallel to the longitudinal axis.

CS 22.595 Load on the attachment point of the parachute ripcord

ED Decision 2003/13/RM

The attachment point for the parachute ripcord (if provided) must be designed for a limit load of 300 daN acting in all possible directions.

CS 22.597 Loads from single masses

ED Decision 2003/13/RM

The attachment means for all single masses, which are part of the equipment of the sailplane, must be designed to withstand loads corresponding to the maximum design load factors to be expected from the established flight and ground loads.

SUBPART D — DESIGN AND CONSTRUCTION

GENERAL

CS 22.601 General

ED Decision 2003/13/RM

The suitability of each questionable design detail and part having an important bearing on safety in operations must be established by test.

CS 22.603 Materials

ED Decision 2003/13/RM

The suitability and durability of materials used for parts, the failure of which could adversely affect safety, must –

- (a) be established by experience or tests; and
- (b) meet approved specifications that ensure their having the strength and other properties assumed in the design data.

CS 22.605 Fabrication methods

ED Decision 2003/13/RM

The methods of fabrication used must produce consistently sound structures. If a fabrication process (such as glueing, spot welding, heattreating, or processing of plastic materials) requires close control to reach this objective, the process must be performed under an approved process specification.

CS 22.607 Locking of connections

ED Decision 2003/13/RM

An approved means of locking must be provided on all connecting elements in the primary structure and in control and other mechanical systems which are essential to safe operation of the sailplane. In particular selflocking nuts may not be used in any bolt subject to rotation in operation, unless a non-friction locking device is used in addition to the selflocking device.

CS 22.609 Protection of structure

ED Decision 2003/13/RM

Each part of the structure must –

- (a) be suitably protected against deterioration or loss of strength in service due to any cause, including –
 - (1) weathering;
 - (2) corrosion; and
 - (3) abrasion; and
- (b) have adequate provisions for ventilation and drainage.

CS 22.611 Accessibility

ED Decision 2003/13/RM

Means must be provided to allow:

- (a) inspection of principal structural elements and control systems;
- (b) replacement of parts normally requiring replacement; and
- (c) adjustment and lubrication as necessary for continued airworthiness.

The means of inspection must be practicable for the inspection intervals established for the item during certification. This must be stated in the maintenance manual required under [CS 22.1529](#).

AMC 22.611 Accessibility

ED Decision 2003/13/RM

The provision of access panels suitably located and in sufficient numbers to enable the proper inspection of structural elements, to allow inspection, adjustment and lubrication of critical parts of the control system, as necessary for continued airworthiness, and the replacement of parts as required, is an acceptable interpretation of, and means of compliance with [CS 22.611](#). 'Inspection' is meant to include daily and other periodic checks.

Where it is impracticable to provide means for direct visual inspection, non destructive inspection aids or special inspection methods may be used to inspect structural elements, when the inspection can be shown to be effective, if such inspection aids are easily obtainable.

CS 22.612 Provisions for rigging and derigging

ED Decision 2003/13/RM

The design of the sailplane must be such that during rigging and de-rigging by untrained persons, the probability of damage or permanent deformation, especially when this is not readily visible, is extremely remote. Incorrect assembly must be avoided by proper design provisions. It must be possible to inspect the sailplane easily for correct rigging.

CS 22.613 Material strength properties and design values

ED Decision 2003/13/RM

- (a) Material strength properties must be based on enough tests to establish design values on a statistical basis.
- (b) The design values must be chosen so that the probability of any structure being understrength because of material variations is extremely remote. (See [AMC 22.613\(b\)](#))
- (c) Where the temperature attained in an essential component or structure in normal operating conditions has a significant effect on strength, that effect must be taken into account. (See [AMC 22.613\(c\)](#))

AMC 22.613(b) Material strength properties and design values

ED Decision 2003/13/RM

Material specifications should be those contained in documents accepted either specifically by the Agency or by having been prepared by an organisation or person which the Agency accepts has the necessary capabilities. In defining design properties these material specification values should be

modified and/or extended as necessary by the constructor to take account of manufacturing practices (for example method of construction, forming, machining and subsequent heat treatment).

AMC 22.613(c) Material strength properties and design values

ED Decision 2003/13/RM

Temperatures up to 54°C are considered to correspond to normal operating conditions.

CS 22.619 Special factors

ED Decision 2003/13/RM

- (a) The factor of safety prescribed in [CS 22.303](#) must be multiplied by appropriate combinations of the special factors prescribed in [CS 22.621](#) through [CS 22.625](#), [CS 22.657](#), [CS 22.693](#) and CS 22.619(b).
- (b) For each part of the structure not covered by [CS 22.621](#) through [CS 22.625](#), [CS 22.657](#) and [CS 22.693](#) but whose strength is
 - (1) uncertain;
 - (2) likely to deteriorate in service before normal replacement; or
 - (3) subject to appreciable variability because of uncertainties in manufacturing processes or inspection methods; the special factor must be chosen so that failure of the part due to inadequate strength is improbable.

AMC 22.619(a) Special factors

ED Decision 2003/13/RM

Appropriate combinations of the special factors should include all those of the following appropriate to the part:

- (1) the casting factor derived in accordance with [CS 22.621](#);
- (2) the highest pertinent special factor prescribed in [CS 22.623](#), [CS 22.625](#), [CS 22.657](#), [CS 22.693](#) or [CS 22.619\(b\)](#); and
- (3) the two-hinge factor prescribed in [CS 22.625\(e\)](#).

CS 22.621 Casting factors

ED Decision 2003/13/RM

For castings the strength of which is substantiated by at least one static test and which are inspected by visual methods, a casting factor of 2.0 must be applied. This factor may be reduced to 1.25 providing the reduction is substantiated by tests on not less than three sample castings and if these and all production castings are subjected to an approved visual and radiographic inspection or an approved equivalent non-destructive inspection method.

CS 22.623 Bearing factors

ED Decision 2003/13/RM

- (a) The factor of safety for bearings at bolted or pinned joints must be multiplied by a special factor of 2.0 to provide for:
 - (1) relative motion in operation; and

- (2) joints with clearance (free fit) subject to pounding and/or vibration.
- (b) For control surface hinges and control system joints, compliance with the factors prescribed in [CS 22.657](#) and [CS 22.693](#), respectively, meets sub-paragraph (a) of this paragraph.

CS 22.625 Fitting factors

ED Decision 2003/13/RM

For each fitting (a part or terminal used to join one structural member to another), the following apply:

- (a) For each fitting whose strength is not proven by limit and ultimate load tests in which actual stress conditions are simulated in the fitting and surrounding structures, a fitting factor of at least 1.15 must be applied to each part of –
 - (1) the fitting;
 - (2) the means of attachment; and
 - (3) the bearing on the joined members.
- (b) No fitting factor need be used for joint designs based on comprehensive test data (such as continuous joints in metal plating, welded joints, and scarf joints in wood).
- (c) For each integral fitting, the part must be treated as a fitting up to the point at which the section properties become typical of the member.
- (d) For each seat, safety belt, and harness, its attachment to the structure must be shown, by analysis, tests, or both, to be able to withstand the inertia forces prescribed in [CS 22.561](#) multiplied by a fitting factor of 1.33.
- (e) When using only two hinges at each control surface, or wing-flap, the safety factor for these hinges and the attached parts of the primary structure must be multiplied by a factor of 1.5.

CS 22.627 Fatigue strength

ED Decision 2003/13/RM

The structure must be designed, as far as practicable, to avoid points of stress concentration where variable stresses above the fatigue limit are likely to occur in normal service.

CS 22.629 Flutter

ED Decision 2003/13/RM

- (a) The sailplane must be free from flutter, aerofoil divergence, and control reversal in each configuration and at each appropriate speed up to at least V_D . Sufficient damping must be available at any appropriate speed so that aeroelastic vibration dies away rapidly.
- (b) Compliance with sub-paragraph (a) must be shown by:
 - (1) a ground vibration test which includes an analysis and an evaluation of the established vibration modes and frequencies for the purpose of recognising combinations critical for flutter, either by:
 - (i) an analytical method, which will determine any critical speed in the range up to $1.2 V_D$, or
 - (ii) any other approved method.

- (2) systematic flight tests to induce flutter at speeds up to V_{DF} . These tests must show that a suitable margin of damping is available and that there is no rapid reduction of damping as V_{DF} is approached.
- (3) flight tests to show that when approaching V_{DF} :
 - (i) control effectiveness around all three axes is not decreasing in an unusually rapid manner, and
 - (ii) no signs of approaching aerofoil divergence of wings, tailplane and fuselage result from the trend of the static stabilities and trim conditions.

CONTROL SURFACES

CS 22.655 Installation

ED Decision 2003/13/RM

- (a) Movable control surfaces must be installed so that there is no interference between any surfaces or their bracings when one surface is held in any position and the others are operated through their full angular movement. This requirement must be met:
 - (1) under limit load (positive or negative) conditions for all control surfaces through their full angular range; and
 - (2) under limit load on the sailplane structure other than control surfaces.
- (b) If an adjustable stabilizer is used, it must have stops that will limit its range of travel to that allowing safe flight and landing.

CS 22.657 Hinges

ED Decision 2003/13/RM

- (a) Control surface hinges, except ball and roller bearing hinges, must have a factor of safety of not less than 6.67 with respect to the ultimate bearing strength of the softest material used as a bearing.
- (b) For ball or roller bearing hinges, the approved rating of the bearing may not be exceeded.
- (c) Hinges must have enough strength and rigidity for loads parallel to the hinge line.

CS 22.659 Mass balance

ED Decision 2003/13/RM

The supporting structure and the attachment of concentrated mass balance weights used on control surfaces must be designed for -

- (a) 24 g normal to the plane of the control surface;
- (b) 12 g fore and aft; and
- (c) 12 g parallel to the hinge line.

CONTROL SYSTEMS

CS 22.671 General

ED Decision 2003/13/RM

Each control must operate easily, smoothly, and positively enough to allow proper performance of its functions.

CS 22.675 Stops

ED Decision 2003/13/RM

- (a) Each control system must have adjustable stops that positively limit the range of motion of each movable aerodynamic surface controlled by the system.
- (b) Each stop must be located so that wear, slackness, or take-up adjustments will not adversely affect the control characteristics of the sailplane because of a change in the range of surface travel.
- (c) Each stop must be able to withstand any loads corresponding to the design conditions for the control system.

CS 22.677 Trim system

ED Decision 2003/13/RM

- (a) Proper precautions must be taken to prevent inadvertent, improper, or abrupt trim tab operation. There must be means near the trim control to indicate to the pilot the direction of trim control movement relative to sailplane motion. In addition, there must be means to indicate to the pilot the position of the trim device with respect to the range of adjustment. This means must be visible to the pilot and must be located and designed to prevent confusion.
- (b) Tab controls must be irreversible unless the tab is properly balanced and has no unsafe flutter characteristics. Irreversible tab systems must have adequate rigidity and reliability in the portion of the system from the tab to the attachment of the irreversible unit to the sailplane structure.

CS 22.679 Control system locks

ED Decision 2003/13/RM

If there is a device to lock the control system on the ground, there must be means to –

- (a) give unmistakable warning to the pilot when the lock is engaged; and
- (b) prevent the lock from engaging in flight.

CS 22.683 Operation tests

ED Decision 2003/13/RM

It must be shown by functional tests that the system designed to the loads specified in [CS 22.397](#) is free from:

- (a) jamming;
- (b) excessive friction; and
- (c) excessive deflection; when operating the controls from the cockpit.

CS 22.685 Control system details

ED Decision 2003/13/RM

- (a) Each detail of each control system must be designed and installed to prevent jamming, chafing, and interference from baggage, passengers, loose objects, or the freezing of moisture.
- (b) There must be means in the cockpit to prevent the entry of foreign objects into places where they would jam the system.
- (c) There must be means to prevent the slapping of cables or rods against other parts.
- (d) Each element of the flight control system must have design features, or must be distinctively and permanently marked, to minimize the possibility of incorrect assembly that could result in malfunctioning of the control system.
- (e) In sailplanes certificated for aerobatic manoeuvres, where necessary the rudder pedals must be provided with loops to prevent the feet from slipping off the pedals.

AMC 22.685(d) Control system details

ED Decision 2003/13/RM

- (1) An automatic connection device in each part of the primary pitch control system which is connected during the rigging of the sailplane is an acceptable means of compliance with this requirement. Means should be provided to guarantee the proper functioning of the primary pitch control system. Normally this should be provided by visual inspection.
- (2) For the other control systems it should be shown that no hazardous situation can occur, due to restrictive movement or jamming of the control system, when a part of the control system is not connected during the rigging of the sailplane.

CS 22.687 Spring devices

ED Decision 2003/13/RM

The reliability of any spring device used in the control system must be established by tests simulating service conditions unless failure of the spring will not cause flutter or unsafe flight characteristics.

CS 22.689 Cable systems

ED Decision 2003/13/RM

- (a) Each cable, cable fitting, turnbuckle, splice, and pulley used must meet approved specifications. In addition –
 - (1) no cable smaller than 3 mm diameter may be used in primary control systems;
 - (2) each cable system must be designed so that there will be no hazardous change in cable tension throughout the range of travel under operating conditions and temperature variations; and
 - (3) there must be means for visual inspection at each fairlead, pulley, terminal, and turnbuckle. The need for this requirement may be waived when it can be shown that airworthiness will not be affected within the service life of these components.
- (b) Each kind and size of pulley must correspond to the cable with which it is used. Each pulley must have closely fitted guards to prevent the cables from being misplaced or fouled, even when slack. Each pulley must lie in the plane passing through the cable so that the cable does not rub against the pulley flange.

- (c) Fairleads must be installed so that they do not cause a change in cable direction of more than 3°, except where tests or experience indicate that a higher value would be satisfactory. The radius of curvature of fairleads must not be smaller than the radius of a pulley for the same cable.
- (d) Turnbuckles must be attached to parts having angular motion in a manner that will positively prevent binding throughout the range of travel.
- (e) Tab control cables are not part of the primary control system and may be less than 3 mm diameter in sailplanes that are safely controllable with the tabs in the most adverse positions.

AMC 22.689(b) Cable systems

ED Decision 2003/13/RM

The inside diameter of the pulley groove should not be less than 300 times the diameter of each elemental strand.

CS 22.693 Joints

ED Decision 2003/13/RM

Control system joints (in push-pull systems) that are subject to angular motion, except those in ball and roller bearing systems, must have a special factor of safety of not less than 3.33 with respect to the ultimate bearing strength of the softest material used as a bearing. This factor may be reduced to 2.0 for joints in cable control systems. For ball or roller bearings, the approved ratings may not be exceeded.

CS 22.697 Wing-flap and air-brake controls

ED Decision 2003/13/RM

- (a) Each wing-flap control must be designed so that, when the wing-flap has been placed in any position upon which compliance with the performance requirements of this Part is based, the wing-flap will not move from that position except when:
 - (1) the control is adjusted; or
 - (2) the wing-flap is moved by the automatic operation of a wing-flap load limiting device; or
 - (3) movement other than in accordance with (1) or (2) is demonstrated not to be hazardous.
- (b) Each wing-flap and air brake must be designed to prevent inadvertent extension or movement. The pilot forces and the rate of movement at any approved flight speed must not be such as to impair the operating safety of the sailplane.
- (c) The air brake or other drag increasing device necessary to show compliance with [CS 22.73](#) and/or [CS 22.75](#) must comply with the following:
 - (1) Where the device is divided into several parts, all parts must be operated by a single control.
 - (2) It must be possible to extend the device at any speed up to 1.05 V_{NE} and to retract the device at any speed up to V_T , but not less than 1.8 V_{S1} , with a hand force not exceeding 20 daN.
 - (3) The time required for extension as well as retraction of the device may not exceed 2 seconds.

CS 22.699 Wing-flap position indicator

ED Decision 2003/13/RM

There must be means near the wing-flap control to indicate to the pilot the position of the wing-flaps during and after operation.

CS 22.701 Wing-flap interconnection

ED Decision 2003/13/RM

The motion of wing-flaps on opposite sides of the plane of symmetry must be synchronized by a mechanical interconnection unless the sailplane has safe flight characteristics with the wing-flaps retracted on one side and extended on the other.

CS 22.711 Release mechanisms

ED Decision 2003/13/RM

- (a) Release mechanisms to be used for winch-launching must be so designed and installed as to release the towing cable automatically (i.e. to back-release) if the sailplane overruns the cable while it is carrying any appreciable load.
- (b) The release mechanisms must be approved.
- (c) It must be extremely improbable for bolts or other projections on the release mechanism itself or the structure surrounding the mechanism, including the landing gear, to foul the towing cable or its parachute.
- (d) It must be shown that the release force will not exceed that prescribed in [CS 22.143\(c\)](#) when a cable load Q_{nom} is applied in any direction (see [CS 22.583](#)), and that the release mechanism functions properly under any operating condition.
- (e) The range of travel of the release lever in the cockpit, including free travel, must not exceed 120 mm.
- (f) The release lever in the cockpit must be arranged and designed so that the pilot force as defined in [CS 22.143\(c\)](#) can be easily applied.
- (g) A visual inspection of the release mechanism must be easily possible.

CS 22.713 Launching hook

ED Decision 2003/13/RM

Depending on the launching method(s) for which certification is requested, the sailplane must be fitted with one or more launching hooks complying with the following:

- (a) Each hook to be used for aerotow launching must be –
 - (1) Designed to minimise the possibility of inadvertent release, and;
 - (2) Installed to minimise the possibility of dangerous upsets during aerotowing (see [CS 22.151\(a\)\(3\)](#)) and to produce a nose-down pitching moment on the sailplane under the conditions of [CS 22.581\(a\)\(3\)](#), but with an angle of not more than 25°.
- (b) Each hook to be used for winch and/or auto-tow launching must be equipped with a release device which is automatically activated when the sailplane overflies the towing winch or auto-tow vehicle.

- (c) The release control system must be designed to actuate the release mechanism of each launching hook at the same time, where more than one launching hook is fitted.

LANDING GEAR

CS 22.721 General

ED Decision 2003/13/RM

- (a) The sailplane must be so designed that it can land on unprepared soft ground without endangering its occupants.
- (b) Each sailplane fitted with retractable landing gear must be designed and constructed so that normal landings with the landing gear retracted are possible.
- (c) The design of wheels, skids and tail skid and their installation must be such as to minimize the possibility of fouling by the towing cable.
- (d) If the main landing gear consists only of one or more wheels, the sailplane must be equipped with mechanical braking devices, such as wheel brakes.
- (e) A shock-absorbing element must be fitted to the tail skid.

CS 22.723 Shock absorption test

ED Decision 2003/13/RM

The proof of sufficient shock absorption capacity must be determined by test. The landing gear must be able to absorb 1.44 times the energy described in [CS 22.473](#) without failure although it may yield during the test.

AMC 22.723 Shock absorption test

ED Decision 2003/13/RM

Where the shock absorption characteristics are not essentially affected by the rate of compression, static tests may be used, but where the characteristics are so affected dynamic tests should be done.

CS 22.725 Level landing

ED Decision 2003/13/RM

- (a) The shock absorbing elements (including tyres) must be capable of absorbing the kinetic energy developed in a landing without being fully depressed.
- (b) The value of kinetic energy must be determined under the assumption that the weight of the sailplane corresponds to the design maximum weight with a constant rate of descent equalling the value given in [CS 22.473\(b\)](#) and the wing lift balancing the weight of the sailplane.
- (c) Under the assumption of (b) the c.g. acceleration must not exceed 4.5 g.

CS 22.729 Retracting mechanism

ED Decision 2003/13/RM

- (a) Each landing gear retracting mechanism and its supporting structure must be designed for the maximum flight load factors occurring with the gear retracted.
- (b) For retractable landing gears it must be shown that extension and retraction of the landing gear are possible without difficulty up to V_{LO} .
- (c) A sailplane equipped with a nonmanually operated landing gear must have an auxiliary means of extending the gear.

CS 22.731 Wheels and tyres

ED Decision 2003/13/RM

- (a) Each landing gear main wheel must be approved.
- (b) The maximum limit load rating of each wheel must equal or exceed the maximum radial limit load determined under the applicable ground load requirements. Each individual wheel of twin and tandem landing gears must be designed to support 70% of the maximum allowable weight.

COCKPIT DESIGN

CS 22.771 General

ED Decision 2003/13/RM

- (a) The cockpit and its equipment must allow each pilot to perform his duties without unreasonable concentration or fatigue.
- (b) A means must be provided to enable ballast provided in accordance with [CS 22.31\(c\)](#) to be stowed safely in the sailplane.

CS 22.773 Cockpit view

ED Decision 2003/13/RM

Each cockpit must be free from glare and reflections that could interfere with the pilot's vision, and designed so that:

- (a) the pilot's vision is sufficiently extensive, clear and undistorted for safe operation; and
- (b) each pilot is protected from the elements. Rain and icing may not unduly impair his view along the flight path in normal flight and during landing.

AMC 22.773(b) Cockpit view

ED Decision 2003/13/RM

Compliance with [CS 22.773\(b\)](#) may be provided by the canopy having a suitable opening.

CS 22.775 Windshields and windows

ED Decision 2003/13/RM

- (a) Windshields and windows must be constructed of a material that will not result in serious injuries due to splintering.
- (b) Windshields and side windows of the canopy must have a luminous transmittance value of at least 70% and must not significantly alter the natural colours.

AMC 22.775(a) Windshields and windows

ED Decision 2003/13/RM

Windshields and windows made of synthetic resins are accepted as complying with this requirement.

CS 22.777 Cockpit controls

ED Decision 2003/13/RM

- (a) Each cockpit control must be located to provide convenient operation, and to prevent confusion and inadvertent operation. (See [AMC 22.777\(a\)](#))
- (b) The controls must be located and arranged so that the pilot, when strapped in his seat, has full and unrestricted movement of each control without interference from either his clothing (including winter clothing) or from the cockpit structure. The pilot must be able to operate all the controls necessary for the safe operation of the aeroplane from the seat designated to be used for solo flying.

- (c) In sailplanes with dual controls it must be possible to operate the following secondary controls from each of the two pilots' seats –
- (1) release mechanism;
 - (2) air brakes;
 - (3) wing-flaps;
 - (4) trim;
 - (5) opening and jettisoning device of the canopy;
 - (6) throttle lever.
- (See [AMC 22.777\(c\)](#))
- (d) Controls must maintain any desired position without requiring constant attention by the pilot(s), and must not tend to creep under system loads or vibration. A means of adjusting the freedom of operation of the throttle control during flight to achieve this must be provided. Controls must have adequate strength to withstand the loads without failure or excessive deflection. (See [AMC 22.777\(d\)](#))

AMC 22.777(a) Cockpit controls

ED Decision 2003/13/RM

The preferred arrangement of the powerplant controls is, from left to right, carburettor heat or alternate air control (if required), power, propeller, and mixture control.

AMC 22.777(c) Cockpit controls

ED Decision 2003/13/RM

The need for a dual trim control may be waived when it is demonstrated that, with the trimmer in the most adverse position, the elevator control forces are sufficiently small and that there is no difficulty in control.

AMC 22.777(d) Cockpit controls

ED Decision 2003/13/RM

Throttle control systems which have been demonstrated to have inherently constant friction levels throughout their life such as Bowden type push/pull cables, are accepted as providing an equivalent level of safety to that of a 'means of adjusting the freedom of operation of the throttle control in flight'.

CS 22.779 Motion and effect of cockpit controls

ED Decision 2003/13/RM

Cockpit controls must be designed so that they operate as follows:

Controls	Motion and effect
Aileron	right (clockwise) for right wing down
Elevator	rearward for nose up
Rudder	right pedal forward for nose right
Trim	corresponding to sense of motion of the controls
Air brakes	pull to extend

Controls	Motion and effect
Wing-flaps	pull for wing-flaps down or extended
Towing cable release	pull to release
Canopy jettisoning	not prescribed, preferably pull to jettison
Throttle control	forward to increase power
Propeller pitch	forward to increase r.p.m.
Mixture	forward, or up for rich
Carburettor air heat or Alternate air	forward or upward for cold, or alternate air off

CS 22.780 Colour marking and arrangement of cockpit controls

ED Decision 2003/13/RM

Cockpit controls must be marked and located as follows:

Control	Colour	Location
Towing cable release	yellow	for left hand operation.
Air brakes	blue	for left hand operation, or, in the case of a two-seat sailplane between the two pilot positions.
Trimmer (longitudinal trim)	green	preferably for left hand operation.
Canopy operating handle	white *	not prescribed.
Canopy jettison handle	red *.	not prescribed but must be within easy reach.
Other controls,	to be clearly marked but not yellow, red	

*If canopy opening and jettison are combined in one handle, the colour must be red.

AMC 22.780 Color marking and arrangement of cockpit controls

ED Decision 2003/13/RM

When two controls are necessary to jettison the canopy and one of those is also used as the normal canopy opening control, its colour should be white with a red ring or band around the handle.

CS 22.781 Cockpit control knob shape

ED Decision 2003/13/RM

The towing cable release control must be so designed to be capable of operation by a gloved hand exerting the force specified in [CS 22.143\(c\)](#).

AMC 22.781 Cockpit control knob shape

ED Decision 2003/13/RM

The control should take the form of a T-shaped handle.

CS 22.785 Seats and safety harnesses

ED Decision 2008/008/R

- (a) Each seat and its supporting structure must be designed for an occupant weight in accordance with [CS 22.25\(a\)\(2\)](#) and for the maximum load factors corresponding to the specified flight and ground conditions including the emergency landing conditions prescribed in [CS 22.561](#). Each

seat and its supporting structure must also be designed to withstand the reaction to the load specified in [CS 22.397\(b\)](#).

- (b) Seats including cushions may not deform to such an extent that the pilot when subjected to loads corresponding to [CS 22.581](#) and [CS 22.583](#), is unable to reach the controls safely, or that the wrong controls are operated.
- (c) Each seat in a sailplane must be designed so that an occupant is comfortably seated, whether he wears a parachute or not. The seat design must allow the accommodation of a parachute worn by an occupant.
- (d) The strength of the safety harness must not be less than that following from the ultimate loads for the flight and ground load conditions and for the emergency landing conditions according to [CS 22.561\(b\)](#) taking into account the geometry of the harness and seat arrangement.
- (e) Each safety harness installation must be designed so that each occupant is safely retained in his initial sitting or reclining position under any acceleration occurring in operation.
- (f) Each seat and safety harness installation must be designed to give each occupant every reasonable chance of escaping serious injury under the conditions of [CS 22.561\(b\)\(1\)](#) and [\(b\)\(2\)](#).

[Amdt 22/1]

AMC 22.785(f) Seats and safety harnesses

ED Decision 2008/008/R

- (1) The arrangement of the safety harness installation should minimise the probability of the occupant's body from either sliding underneath the belts or sliding laterally when subjected to inertia loads acting in the forward or sideward direction, respectively.
- (2) For semi-reclined seating positions the anchorage points of the lap belt should be located well below and behind the H-Point at an angle between 80 ± 10 degrees to the datum line through the H-Point parallel to the longitudinal axis of the sailplane.

The H-Point (Hip-point) is the pivot between the torso centre line and the thigh centre line of the occupant.

The determination of the H-Point, or the anchorage point of the lap belt, should be made by a rational method. An acceptable means is contained in CS-22, Book 1, [Appendix J](#).

- (3) The anchorage points of the shoulder belts should be located below and behind the pilots shoulders at an angle of $15^\circ +2^\circ/-0^\circ$ to a line parallel to the longitudinal axis of the sailplane for a 50 percentile male. The lateral separation should be not more than 200 mm.

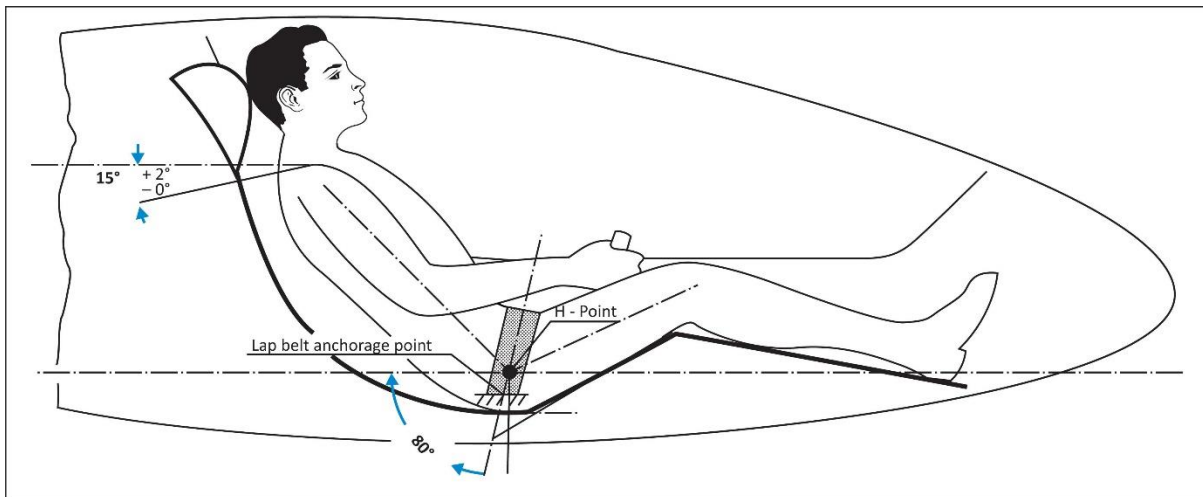

- (4) The design of the shoulder harness supporting structure has to consider the combination of the occupant ultimate inertia forces corresponding to a forward acceleration from [CS 22.561\(b\)\(1\)](#) combined with fuselage loads and possible side deformation resulting from the ultimate load defined under [CS 22.561\(b\)\(2\)](#).

[Amdt 22/1]

Appendix J – Process of H-point determination

ED Decision 2003/13/RM

(see [CS 22.785\(f\)](#))

For the H-point determination, the thigh contact area and the seat level are the two reference areas in a cockpit.

- a) Levelling the sailplane

The sailplane should be adjusted with the longitudinal axis horizontal and the wings level

- b) Placing and adjusting of the device

With the thighs below the transitional area of seat level and thigh contact area, the device is placed in the centre of the thigh contact area. The device is then slowly pushed down to the thigh contact area until the two lower ends of the thighs touch the seat pan at the same time. This process should ensure that the thighs fully touch the thigh contact area at all times.

When both of the thighs have optimum contact with the thigh contact area or seat level, the device should be adjusted with the use of a spirit level until horizontal at the contact point and fixed in that position.

- c) Marking of H-point and determination of optimum location of lap belt anchorage points

When the device is adjusted, the H-point device axis is pushed to one side until a felt-tip pen that is attached to the device touches the side wall of the seat pan. The H-point should be marked at this position. The same procedures should be repeated for the other side.

Continued adjustment of the device should enable the marking of the H-point for each adjusted position.

A rectangle should be drawn around all H-points marked on the side wall of the seat pan, which should be as small as possible. The intersecting point of the rectangle's diagonal shows the "determined H-point".

For the determination of optimum area for the anchorage point of the lap belts, the device is placed on the seat pan in such a way that the H-point of the device corresponds with the "determined H-point" of the seat pan.

The stencil should then be adjusted with the spirit level attached to it allowing the H-point axis to be fixed with the locking device in the connecting part. The area required for the anchorage point of the lap belt can then be identified on the stencil.

H-Point device

The device is basically composed of the two thighs, the connecting part, and the H-Point axis (see figure 1).

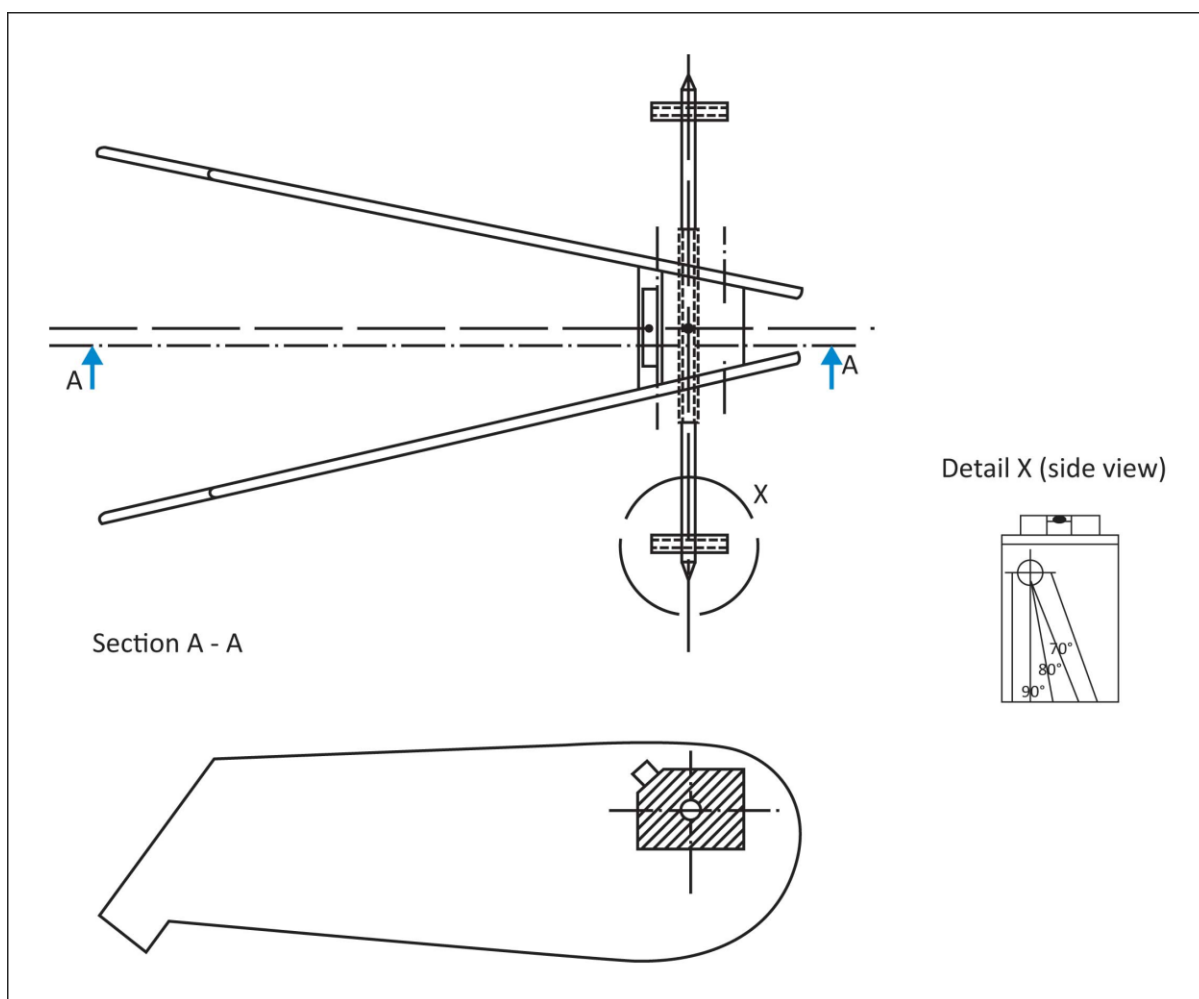

Figure 1

The original constructional drawing of the H-Point device can be ordered by

TÜV Rheinland Kraftfahrt GmbH
 Institut für Verkehrssicherheit
 Abteilung Luftfahrttechnik
 Am Grauen Stein
 D-51105 Köln

CS 22.786 Protection from injury

ED Decision 2003/13/RM

- (a) Rigid structural members or rigidly mounted items of equipment, must be padded where necessary to protect the occupant(s) from injury during minor crash conditions.
- (b) Structural members, which by the nature of their size or shape are capable of piercing the instrument panel, must be designed or positioned such that injury to occupants is unlikely, under the conditions of [CS 22.561\(b\)\(2\)](#).

CS 22.787 Baggage compartment

ED Decision 2008/008/R

- (a) Each baggage compartment must be designed for its placarded maximum weight of contents and for the critical load distributions at the appropriate maximum load factors corresponding to the flight and ground load conditions of this Part.
- (b) Means must be provided to protect occupants from injuries by movement of the contents of baggage compartments under an ultimate forward acceleration of 15.0 g.

[Amdt 22/1]

CS 22.788 Headrests

ED Decision 2003/13/RM

- (a) A headrest must be provided to protect each occupant from rebound injuries in the event of a crash landing. It must be equipped with energy absorbent padding protected against wear and weathering encountered in normal operation. If an adjustable headrest is provided it must be capable of being positioned such that the point of head contact is at eye level. (See [AMC 22.788\(a\)](#))
- (b) Each headrest must be so designed to minimize the possibility of clothing or the parachute becoming caught when bailing out. (See [AMC 22.788\(b\)](#))
- (c) Each headrest in its most critical position must be designed for an ultimate load of at least 135 daN normal to a vertical plane which touches the contact point of the head.
- (d) The width and design of the headrest must not unduly restrict vision from either seat.

AMC 22.788 Headrests

ED Decision 2003/13/RM

- (a) If possible, the structure of the headrest should be integrated into the backrest of each seat.
- (b) Each headrest should be so designed that protection from injuries referred to in paragraph [CS 22.788\(a\)](#) is ensured for each occupant irrespective of whether or not a parachute is worn.

CS 22.807 Emergency exit

ED Decision 2009/009/R

- (a) The cockpit must be so designed that unimpeded and rapid escape in emergency situations during flight and in any normal or crash attitude on the ground is possible with the occupant wearing a parachute. (See [AMC 22.807\(a\)](#))
- (b) The opening, and where appropriate jettisoning, of each canopy or emergency exit must not be prevented by the presence of the appropriate aerodynamic forces and/or the weight of the

canopy at speeds up to V_{DF} or by jamming of the canopy with other parts of the sailplane. The canopy or emergency exit attachment fittings must be designed to permit easy jettisoning, where jettisoning is a necessary feature of the design.

- (c) The opening system must be designed for simple and easy operation. It must function rapidly and be designed so that it can be operated by each occupant strapped in his seat and also from outside the cockpit.
- (d) A canopy or emergency exit jettison system must be actuated by not more than two controls, either or both of which must remain in the open position. The canopy jettisoning controls must be capable of being operated with a pilot effort of between 5 and 15 daN. If two controls are used they must both move in the same sense to jettison the canopy. If there are controls for each pilot, both controls or sets of controls must move in the same sense. If a single control is used for jettisoning, it must be designed to minimise the risk of inadvertent or unintentional operation towards the jettison position.
- (e) In order to enable the occupants to bail out under acceleration conditions, sufficiently strong cabin parts, or grab-handles, must be available and suitably located so that the occupants can lift themselves out of their seats and support themselves. These parts must be designed to an ultimate load of at least 200 daN in the anticipated direction of force application.

[Amdt 22/2]

AMC 22.807(a) Emergency Exits

ED Decision 2009/009/R

When assessing ground escape, the possibility of the aircraft coming to rest in an inverted (turnover) position should be determined.

If it is determined that an aircraft design is not susceptible to turnover, then no further action is necessary. If however turnover remains a distinct possibility or is questionable, provisions should be made in the basic aircraft design to allow the occupants to make a rapid escape from a turnover position. This may include the design of the emergency exit or fuselage, the use of materials which are readily breakable or by installing weak points in the fuselage or canopy.

As an alternative to provisions within the basic aircraft design, it is acceptable to install qualified escape equipment (e.g. crash axe) that would permit the occupant(s) to make a rapid escape from the inverted position. In such a case, it would not be necessary to consider the wearing of a parachute, as escape could be made more rapid if the occupant(s) released their parachute(s) prior to egress rather than attempt to enlarge an escape opening or risk getting entangled. In order to qualify escape equipment, it must be shown by test or by similarity with previous tests, that the equipment can perform its intended function.

[Amdt 22/2]

CS 22.831 Ventilation

ED Decision 2003/13/RM

- (a) The cockpit must be designed so as to afford suitable ventilation under normal flying conditions.
- (b) Carbon monoxide concentration must not exceed one part per 20 000 parts air.

CS 22.857 Electrical bonding

ED Decision 2003/13/RM

- (a) Electrical continuity must be provided to prevent the existence of differences of potential between components of the powerplant including fuel and other tanks, and other significant parts of the powered sailplane which are electrically conductive.
- (b) If the sailplane is equipped for winch or auto launching, electrical continuity must be provided between the metallic parts of the cable release mechanism and the control column.
- (c) The cross-sectional area of bonding connectors, if made from copper, must not be less than 1.33 mm².

CS 22.881 Ground handling

ED Decision 2003/13/RM

There must be reliable carrying and lifting provisions for the sailplane.

CS 22.883 Ground clearance

ED Decision 2003/13/RM

- (a) There must be at least 0.10 m of ground clearance for the tailplane with the wing-tip touching the ground.
- (b) With the wing-tip touching the ground, the associated aileron may not touch the ground when deflected fully down.

CS 22.885 Fairings

ED Decision 2003/13/RM

Removable fairings must be positively attached to the structure.

CS 22.891 Water ballast tanks: general

ED Decision 2003/13/RM

Each water ballast tank, its surrounding structure, hoses, valves and fittings, must be able to withstand, without failure, the vibration, inertia, fluid head (partial and full tank, wing deflections in flight and filling procedures) loads from filling procedures and structural loads that may be encountered in service.

CS 22.892 Water ballast tank: tests

ED Decision 2003/13/RM

Unless loads from [CS 22.891](#) are higher each water tank including hoses, valves and fittings, must be able to withstand a pressure of 0.20 bar without failure or leakage.

CS 22.893 Water ballast tank installation

ED Decision 2003/13/RM

- (a) General. The surrounding aircraft structure must be appropriately protected from any likely damage (corrosion, debonding, etc.) from water ballast leaks.
- (b) Water ballast tanks which are not an integral part of the structure must be supported so that the loads resulting from the mass of the water ballast are not concentrated. In addition:

- (1) Means must be provided to prevent chafing between each tank and the supporting structure.
- (2) Each tank compartment must be vented and drained
- (c) For integral tanks the surrounding structure must either be shown to be impervious to ballast absorption, or suitably protected.

CS 22.894 Water ballast tank vents

ED Decision 2003/13/RM

Integral and other non flexible tanks must be vented.

CS 22.895 Water ballast system

ED Decision 2003/13/RM

- (a) The water ballast control and jettison system must be designed so that any single malfunction will not produce a lateral or longitudinal movement of the centre of gravity that prevents continued safe flight and landing.
- (b) Water contamination of the pitot/static system, or water collection in any parts of the sailplane where it could cause corrosion or produce significant centre of gravity changes, must be prevented.

AMC 22.895(a) Water ballast

ED Decision 2003/13/RM

Depending on the complexity of the water ballast system it would normally be necessary to carry out failure modes and effects analysis which should include likely dormant failure modes.

If water ballast is carried in more than one tank:

- (1) simultaneous release of water ballast should be achieved by a single lever operation.
- (2) the rate of jettison of water ballast should not result in the centre of gravity moving outside the limitations established under [CS 22.23](#).

CS 22.896 Water ballast drains

ED Decision 2003/13/RM

There must be means to allow drainage of the entire water ballast system with the sailplane in the normal ground attitude.

CS 22.897 Water ballast additives

ED Decision 2003/13/RM

If water ballast additives are permitted by the Flight Manual, they must be shown to have no adverse or damaging effects on structure or systems critical to flight safety.

SUBPART E — POWER-PLANT

GENERAL

CS 22.901 Installation

ED Decision 2003/13/RM

- (a) For the purpose of this CS-22, the sailplane power-plant installation includes each component that –
 - (1) is necessary for propulsion; and
 - (2) affects the safety of the propulsive unit.
- (b) The power-plant must be constructed, arranged and installed to –
 - (1) ensure safe operation; and
 - (2) be accessible for necessary inspections and maintenance.

CS 22.902 Installation: sailplanes with retractable power-plants or propellers

ED Decision 2003/13/RM

Powered sailplanes with retractable power-plants or propellers must comply with the following:

- (a) Retraction and extension must be possible without risk of damage and without the use of exceptional skill or effort or excessive time.
- (b) It must be possible to secure the retraction (extension) mechanism in the extreme positions. There must be a means to inform the pilot that this mechanism is secured in the fully retracted or extended position.
- (c) Any doors associated with extension and retraction must not impair extension and retraction and they must be restrained against spontaneous opening.
- (d) The installation must be so designed as to prevent the heat of the engine from causing a fire or other hazardous condition.
- (e) Fuel or lubricant must not discharge in dangerous quantities from the engine, its components or accessories, when the power-plant is in the retracted position and during extension and retraction.

CS 22.903 Engines

ED Decision 2003/13/RM

- (a) The engine must meet the specifications of Subpart H.
- (b) Restarting of the engine in flight must be possible.

CS 22.905 Propellers

ED Decision 2003/13/RM

The propeller must meet the specifications of Subpart J.

CS 22.925 Propeller clearance

ED Decision 2003/13/RM

If an unshrouded propeller is to be installed, propeller clearances with the powered sailplane at maximum weight, with the most adverse c.g. and with the propeller in the most adverse pitch position, may not be less than the following:

- (a) *Ground clearance.* There must be a clearance of at least 180 mm (for a powered sailplane with a nose-wheel landing gear) or 230 mm (for a powered sailplane with a tail-wheel landing gear) between the propeller and the ground, with the landing gear statically deflected and in the level attitude, normal take-off attitude or taxiing attitude, whichever is most critical. In addition, there must be positive clearance between the propeller and the ground in the level take-off attitude, with:
 - (1) the critical tyre completely deflated and the corresponding landing gear strut statically deflected; and
 - (2) the critical landing gear strut bottomed and the corresponding tyre statically deflected.
- (b) *Structural clearance.* There must be:
 - (1) At least 25 mm radial clearance between the blade tips and the sailplane structure, plus any additional radial clearance necessary to prevent harmful vibration;
 - (2) At least 13 mm longitudinal clearance between the propeller blades or cuffs and stationary parts of the sailplane; and
 - (3) Positive clearance between other rotating parts of the propeller or spinner and stationary parts of the sailplane.

FUEL SYSTEM

CS 22.951 General

ED Decision 2003/13/RM

- (a) Each fuel system must be constructed and arranged to ensure a flow of fuel at a rate and pressure established for proper engine functioning under any normal operating condition.
- (b) Each fuel system must be arranged so that no fuel pump can draw fuel from more than one tank at a time. Gravity feed systems may not supply fuel to the engine from more than one tank at a time, unless the air spaces are interconnected in a manner to ensure that all interconnected tanks feed equally.

CS 22.955 Fuel flow

ED Decision 2003/13/RM

- (a) *Gravity systems.* The fuel flow rate for gravity systems (main and reserve supply) must be 150% of the take-off fuel consumption of the engine.
- (b) *Pump systems.* The fuel flow rate for each pump system (main and reserve supply) must be 125% of the take-off fuel consumption of the engine at the maximum power established for take-off.

CS 22.959 Unusable fuel

ED Decision 2003/13/RM

The unusable fuel supply for each tank must be established as not less than that quantity at which the first evidence of malfunctioning occurs under the most adverse fuel feed conditions occurring during take-off, climb, approach and landing involving that tank.

CS 22.963 Fuel tanks: general

ED Decision 2003/13/RM

- (a) Each fuel tank must be able to withstand, without failure, the vibration, inertia, fluid and structural loads that it may be subjected to in operation.
- (b) Each flexible fuel tank must be of an acceptable kind.

CS 22.965 Fuel tank tests

ED Decision 2003/13/RM

- (a) Each fuel tank must be able to withstand the following pressures without failure or leakage:
 - (1) for each conventional metal tank and non-metallic tank with walls not supported by the sailplane structure, a pressure of 0.25 bar;
 - (2) for each non-metallic tank with walls supported by the sailplane structure and constructed in an acceptable manner using acceptable basic tank material, and with actual or simulated support conditions, a pressure of 0.14 bar for the first tank of a specific design.

CS 22.967 Fuel tank installation

ED Decision 2003/13/RM

- (a) Each fuel tank must be supported so that the loads resulting from the weight of the fuel are not concentrated. In addition:
 - (1) there must be pads, if necessary, to prevent chafing between each tank and its supports; and
 - (2) materials employed for supporting the tank or padding the supporting members must be non-absorbent or treated to prevent the absorption of fuel.
- (b) Each tank compartment must be ventilated and drained to prevent accumulation of flammable fluids and vapours. Each compartment adjacent to a tank must be treated in a similar manner.
- (c) No fuel tank may be located on the engine side of the firewall. There must be at least 15 mm of clearance between the fuel tank and the firewall.
- (d) If the fuel tank is installed in the personnel compartment, it must be demonstrated that adequate ventilation and drainage are provided, that the presence of the tank will in no way interfere with the operation of any part of the powered sailplane, or the normal movement of occupants, and that no leaking fuel will fall directly on to any occupant.
- (e) Fuel system components which could cause leakage of fuel as a result of a wheels-up landing must be suitably protected from damage.

CS 22.969 Fuel tank expansion space

ED Decision 2003/13/RM

Each fuel tank must have an expansion space of sufficient capacity, but of not less than 2% of the tank capacity, to prevent spillage of fuel onto the surfaces of the sailplane due to thermal expansion, sloping ground or any normal ground attitude or manoeuvre, unless the design of the venting system precludes such spillage. It must not be possible to fill the expansion space inadvertently with the powered sailplane in any normal ground attitude.

CS 22.971 Fuel tank sump

ED Decision 2003/13/RM

- (a) Each fuel tank must have a drainable sump with an effective capacity, in the normal ground and flight attitudes, of 0.10% of the tank capacity, or 120 cm³, whichever is the greater, unless –
 - (1) the fuel system has a sediment bowl or chamber that is accessible for drainage and has a capacity of 25 cm³;
 - (2) each fuel tank outlet is located so that, in the normal ground attitude, water will drain from all parts of the tank to the sediment bowl or chamber.
- (b) The drainage system must be readily accessible and easy to drain.
- (c) Each fuel system drain must have manual or automatic means for positive locking in the closed position.

CS 22.973 Fuel tank filler connection

ED Decision 2003/13/RM

Fuel tank filler connections must be located outside personnel compartments, except where the fuel tank must be taken out of those compartments for refuelling. Spilled fuel must be prevented from entering the fuel tank compartment or any part of the powered sailplane other than the tank itself.

CS 22.975 Fuel tank vents

ED Decision 2003/13/RM

Each fuel tank must be vented as close as practicable to the highest point of the tank installation, or from the top part of the expansion space where this is required to be provided. In addition:

- (a) Each vent outlet must be located and constructed in a manner that minimizes the possibility of its being obstructed by ice or other foreign matter.
- (b) Each vent must be constructed to prevent siphoning of fuel during normal operation.
- (c) Each vent must discharge clear of the powered sailplane.

CS 22.977 Fuel strainer or filter

ED Decision 2003/13/RM

- (a) There must be a fuel filter between the fuel tank outlet and the carburettor inlet (or an engine driven fuel pump, if any).
- (b) There must be a finger strainer with 3 to 6 meshes per cm at the outlet of each fuel tank. The length of each strainer must be at least twice the diameter of the fuel tank outlet.
- (c) Each filter or strainer must be easily accessible for drainage and cleaning.

CS 22.993 Fuel system lines and fittings

ED Decision 2003/13/RM

- (a) Each fuel line must be installed and supported to prevent excessive vibration and to withstand loads due to fuel pressure and accelerated flight conditions.
- (b) Each fuel line connected to components of the sailplane between which relative motion could exist must have provisions for flexibility.
- (c) Each flexible hose must be approved or must be shown to be suitable for the particular application.
- (d) Each fuel line and fitting in any area subject to engine fire conditions must be at least fire-resistant.

CS 22.995 Fuel valves and controls

ED Decision 2003/13/RM

- (a) There must be a means to allow the pilot to shut off rapidly in flight the fuel to the engine.
- (b) No shut-off valve may be on the engine side of any firewall.
- (c) The portion of the line between the fuel cock and the carburettor must be as short as possible.
- (d) Each fuel tank selector must –
 - (1) Require a separate and distinct action to place the selector in the „OFF“ position; and

- (2) Have the tank selector positions located in such a manner that it is impossible for the selector to pass through the „OFF“ position when changing from one tank to another.

OIL SYSTEM

CS 22.1011 General

ED Decision 2003/13/RM

- (a) If an engine is provided with an oil system, it must be capable of supplying the engine with an appropriate quantity of oil at a temperature not exceeding the maximum established as safe for continuous operation.
- (b) Each oil system must have a usable capacity adequate for the endurance of the powered sailplane.

CS 22.1013 Oil tanks

ED Decision 2003/13/RM

- (a) Each oil tank must be installed to:
 - (1) meet the requirements of [CS 22.967\(a\), \(b\) and \(d\)](#); and
 - (2) withstand any vibration, inertia and fluid loads expected in operation.
- (b) The oil level must be easy to check without having to remove any cowling parts (with the exception of oil tank access covers) or to use any tools.
- (c) If the oil tank is installed in the engine compartment it must be made of fireproof material.

CS 22.1015 Oil tank tests

ED Decision 2003/13/RM

Oil tanks must be subjected to the tests specified in [CS 22.965](#) for fuel tanks, except that in the pressure tests a pressure of 0.35 bar must be applied.

CS 22.1017 Oil lines and fittings

ED Decision 2003/13/RM

- (a) Oil lines must comply with [CS 22.993](#) and each oil line and fitting must be made of fireproof material.
- (b) *Breather lines.* Breather lines must be arranged so that:
 - (1) condensed water vapour or oil that might freeze and obstruct the line cannot accumulate at any point;
 - (2) the breather discharge will not constitute a fire hazard if foaming occurs or cause emitted oil to strike the pilot's wind shields;
 - (3) the breather does not discharge into the engine air induction system;
 - (4) if the engine is retractable, there must be no discharge of oil from the breather line when the engine is completely retracted.

COOLING

CS 22.1041 General

ED Decision 2003/13/RM

The power-plant cooling provisions must be able to maintain the temperatures of power-plant components and engine fluids within the temperature limit established by the engine constructor during all likely operating conditions.

CS 22.1047 Cooling test procedure for reciprocating engine powered sailplanes

ED Decision 2003/13/RM

- (a) To determine compliance with the requirement of [CS 22.1041](#), a cooling test must be carried out as follows:
 - (1) Engine temperatures must be stabilized in flight with the engine at not less than 75% of maximum continuous power.
 - (2) After temperatures have stabilized, a climb must be begun at the lowest practical altitude and continued for one minute with the engine at take-off power.
 - (3) At the end of one minute, the climb must be continued at maximum continuous power for at least 5 minutes after the occurrence of the highest temperature recorded.
- (b) The climb required in (a) must be conducted at a speed not more than the best rate-of-climb speed with maximum continuous power.
- (c) The maximum anticipated air temperature (hot-day conditions) is 38°C at sea-level. Above sea-level, the temperature decreases with a temperature gradient of 6.5°C per 1 000 m altitude. If the tests are conducted under conditions deviating from this value, the recorded temperatures must be corrected according to (d), unless a more rational method is applied.
- (d) The temperatures of the engine fluids and of the power-plant components (with the exception of cylinder barrels) must be corrected by adding to them the difference between the maximum ambient anticipated air temperature and the temperature of the ambient air at the time of the first occurrence of the maximum recorded component or fluid temperature.

INDUCTION SYSTEM

CS 22.1091 Air induction

ED Decision 2003/13/RM

The air induction system for the engine must supply the air required by the engine under all likely operating conditions.

CS 22.1093 Induction system icing protection

ED Decision 2003/13/RM

- (a) Except as permitted by (b), each engine having a conventional venturi carburettor must be provided with a pre-heater capable, in air free of visible moisture at a temperature of -1°C , of increasing the intake air temperature by 50°C with the engine at 75% of maximum continuous power.
- (b) Where the intake air is continuously heated, and it is demonstrated that the temperature rise is adequate, a pre-heater need not be provided.

CS 22.1103 Induction system ducts

ED Decision 2003/13/RM

- (a) Each induction system duct must have a drain to prevent the accumulation of fuel or moisture in the normal ground and flight attitudes. No drain may discharge where it will cause a fire hazard.
- (b) Each duct connected to components between which relative motion could exist must have means for flexibility.

CS 22.1105 Induction system screens

ED Decision 2003/13/RM

If induction system screens are used –

- (a) each screen must be upstream of the carburettor;
- (b) it must be impossible for fuel to strike the screen.

EXHAUST SYSTEM

CS 22.1121 General

ED Decision 2003/13/RM

- (a) The exhaust system must ensure safe disposal of exhaust gases without fire hazard or carbon monoxide contamination in any personnel compartment.
- (b) Each exhaust system part with a surface hot enough to ignite flammable fluids or vapours must be located or shielded so that leakage from any system carrying flammable fluids or vapours will not result in a fire caused by impingement of the fluids or vapours on any part of the exhaust system, including shields for the exhaust system.
- (c) Each exhaust system component must be separated by fireproof shields from adjacent flammable parts of the sailplane that are outside the engine compartment.
- (d) No exhaust gases may discharge dangerously near any oil or fuel system drain.
- (e) No exhaust gases may be discharged where they will cause a glare seriously affecting pilot vision at night.
- (f) Each exhaust system component must be ventilated to prevent points of excessively high temperature.

CS 22.1125 Exhaust manifold

ED Decision 2003/13/RM

- (a) The exhaust manifold must be fireproof and corrosion-resistant, and must have means to prevent failure due to expansion by operating temperature.
- (b) The exhaust manifold must be supported to withstand the vibration and inertia loads to which it may be subjected in normal operation.
- (c) Parts of the manifold connected to components between which relative motion could exist must have means for flexibility.

POWER-PLANT CONTROLS AND ACCESSORIES

CS 22.1141 General

ED Decision 2003/13/RM

The portion of each power-plant control located in the engine compartment that is required to be operated in the event of fire must be at least fire-resistant.

CS 22.1145 Ignition switches

ED Decision 2003/13/RM

- (a) Each ignition circuit must be independently switched, and must not require the operation of any other switch for it to be made operative.
- (b) Ignition switches must be arranged and designed to prevent inadvertent operation.
- (c) The ignition switch must not be used as the master switch for other circuits.

CS 22.1149 Propeller speed and pitch controls

ED Decision 2003/13/RM

- (a) Propeller speed and pitch must be limited to values that ensure safe operation under normal operating conditions. In addition -
 - (1) If there are propeller speed or pitch controls, their operation must not require undue attention or exceptional skill.
 - (2) For variable pitch propellers provisions must be made for a positive indication that
 - (i) the allowable pitch range for engine start; and
 - (ii) the take-off pitch position has been reached.
- (b) Propellers that cannot be controlled in flight must meet the following requirements:
 - (1) during take-off and initial climb at V_Y , the propeller must limit the engine rotational speed at full throttle to a value not greater than the maximum allowable take-off rotational speed, and
 - (2) during a glide at V_{NE} with throttle closed or the engine inoperative, provided this has no detrimental effect on the engine, the propeller must not permit the engine to achieve a rotational speed greater than 110% of the maximum continuous speed.
 - (3) For powered sailplanes capable of extending and retracting the powerplant during a glide at V_{PE} with the throttle closed, the propeller must not permit the engine to achieve a rotational speed of more than 110% of the max. continuous speed. V_{PE} must not be less than $1.4 V_{S1}$ where V_{S1} is the stalling speed with the wing flaps neutral at maximum weight.
- (c) A propeller that can be controlled in flight but does not have constant speed controls must be so designed that -
 - (1) [CS 22.1149\(b\)\(1\)](#) is met with the lowest possible pitch selected, and
 - (2) [CS 22.1149\(b\)\(2\)](#) is met with the highest possible pitch selected.
- (d) A controllable pitch propeller with constant speed controls must comply with the following requirements:

- (1) with the governor in operation, there must be a means to limit the maximum engine rotational speed to the maximum allowable take-off speed, and
- (2) with the governor inoperative, there must be a means to limit the maximum engine rotational speed to 103% of the maximum allowable take-off speed with the propeller blades at the lowest possible pitch and the powered sailplane stationary with no wind.

CS 22.1163 Power-plant accessories

ED Decision 2003/13/RM

- (a) Each engine-driven accessory must -
 - (1) be satisfactory for mounting on the engine concerned; and
 - (2) use the provisions on the engine for mounting.
- (b) Electrical equipment subject to arcing or sparking must be installed to minimize the probability of contact with any flammable fluids or vapours that might be present in a free state.

CS 22.1165 Engine ignition systems

ED Decision 2003/13/RM

- (a) Each battery ignition system must be supplemented by a generator that is automatically available as an alternative source of electrical energy to allow continued engine operation if any battery becomes depleted.
- (b) The capacity of the batteries and generators must be large enough to meet the simultaneous demands of the engine ignition system and the greatest demands of any other electrical system components that draw from the same source.
- (c) There must be a means to warn the pilot if, while the engine is running, malfunctioning of any part of the electrical system is causing continuous discharge of any battery used for engine ignition.

POWER-PLANT FIRE PROTECTION

CS 22.1191 Firewalls

ED Decision 2003/13/RM

- (a) The engine must be isolated from the rest of the sailplane by a firewall, shroud or equivalent means.
- (b) The firewall or shroud must be constructed so that no hazardous quantity of liquid, gas or flame can pass from the engine compartment to other parts of the sailplane.
- (c) The firewall and shroud must be fireproof and protected against corrosion.

AMC 22.1191(c) Firewalls

ED Decision 2003/13/RM

The following materials are accepted as fireproof, when used in firewalls or shrouds, without being tested -

- (1) stainless steel sheet, 0.38 mm thick;
- (2) mild steel sheet (coated with aluminium or otherwise protected against corrosion) 0.5 mm thick;
- (3) steel or copper base alloy firewall fittings.

CS 22.1193 Cowling and nacelle

ED Decision 2003/13/RM

- (a) Each cowling must be constructed and supported so that it can resist any vibration, inertia and air loads to which it may be subjected in operation.
- (b) There must be a means for rapid and complete drainage of each part of the cowling in the normal ground and flight attitudes. No drain may discharge where it will cause a fire hazard.
- (c) Cowling must be at least fire-resistant.
- (d) Each part behind an opening in the engine compartment cowling must be at least fire-resistant for a distance of at least 600 mm aft of the opening.
- (e) Each part of the cowling subjected to high temperatures due to its nearness to exhaust system ports or exhaust gas impingement, must be fireproof.

SUBPART F — EQUIPMENT

GENERAL

CS 22.1301 Function and installation

ED Decision 2003/13/RM

- (a) Each item of required equipment must:
- (1) be of a kind and design appropriate to its intended function;
 - (2) be labelled as to its identification, function, or operating limitations, or any applicable combination of these factors;
 - (3) be installed according to limitations specified for that equipment; and
 - (4) function properly when installed.
- (b) Instruments and other equipment may not in themselves, or by their effect upon the sailplane, constitute a hazard to safe operation.

AMC 22.1301(a)(4) Function and installation

ED Decision 2003/13/RM

- (1) The correct functioning should not be impaired by icing, heavy rain or high humidity.
- (2) When ATC equipment is installed it should be shown that the electrical system is such that the operation of this equipment is not adversely affected.

CS 22.1303 Flight and navigation instruments

ED Decision 2003/13/RM

The following are required flight and navigation instruments:

- (a) For all sailplanes:
- (1) an air-speed indicator;
 - (2) an altimeter.
- (b) *For powered sailplanes.* In addition to the instruments required in [CS 22.1303\(a\)](#):
- (1) a magnetic direction indicator.
- (c) *For sailplanes of Category A.* In addition to the instruments required in [CS 22.1303\(a\)](#) and [\(b\)](#):
- (1) an accelerometer capable of retaining maximum and minimum values of acceleration for any selected period of flight.
- (d) *For sailplanes equipped for water ballast.* In addition to the instruments required in [CS 22.1303\(a\), \(b\) and \(c\)](#).
- (1) An outside air temperature gauge.

CS 22.1305 Power-plant instruments

ED Decision 2003/13/RM

The following are the required power-plant instruments for powered sailplanes:

- (a) a tachometer;
- (b) a fuel quantity indicator for each fuel tank;
- (c) an oil temperature indicator except for two stroke engines;
- (d) an oil pressure indicator or warning device except for two stroke engines;
- (e) a cylinder head temperature indicator for each air-cooled engine when cowl flaps are used;
- (f) an elapsed-time indicator;
- (g) an oil quantity indicator for each tank, e.g. dipstick,
- (h) a manifold pressure indicator for an engine equipped with a variable pitch propeller, where manifold pressure and rotational speed are independently controllable.
- (i) for pump-fed engines, one of the following instruments/procedures
 - (1) a fuel pressure indicator
 - (2) a low fuel pressure warning
 - (3) a special preflight procedure

AMC 22.1305(i) Power-plant instruments

ED Decision 2003/13/RM

If a special preflight procedure is established, it should be furnished as required by [CS 22.1585\(l\)](#) and [CS 22.1541](#).

CS 22.1307 Miscellaneous equipment

ED Decision 2003/13/RM

An approved safety harness must be available to each occupant.

INSTRUMENTS: INSTALLATION

CS 22.1321 Arrangement and visibility

ED Decision 2003/13/RM

Flight and navigation instruments must be clearly arranged and plainly visible to each pilot.

AMC 22.1321 Arrangement and visibility

ED Decision 2003/13/RM

In order to comply with this requirement, duplication of the flight instruments may be necessary for sailplanes and powered sailplanes with dual control.

CS 22.1322 Warning, caution, and advisory lights

ED Decision 2003/13/RM

If warning, caution, or advisory lights are installed in the cockpit, they must, unless otherwise approved by the Agency, be:

- (a) Red, for warning lights (lights indicating a hazard which may require immediate corrective action);
- (b) Amber, for caution lights (lights indicating the possible need for future corrective action);
- (c) Green, for safe operation lights; and
- (d) any other colour, including white, for lights not described in sub-paragraphs (a) to (c) of this paragraph, provided the colour differs sufficiently from the colours prescribed in sub-paragraphs (a) to (c) of this paragraph to avoid possible confusion.
- (e) Effective under all probable cockpit lighting conditions.

CS 22.1323 Air-speed indicating system

ED Decision 2003/13/RM

- (a) The air-speed indicating system must be calibrated to indicate true air-speed at sea-level in standard atmosphere with a maximum pitot-static error not exceeding ± 8 km/h or $\pm 5\%$ whichever is greater, throughout the following speed range $1.2 V_S$ to V_{NE} , and with wing-flaps neutral and air brakes closed.
- (b) Calibration must be made in flight.
- (c) The air-speed indicating system must be suitable for speeds between V_{S0} and at least 1.05 times V_{NE} .

CS 22.1325 Static pressure system

ED Decision 2003/13/RM

- (a) Each instrument provided with static pressure case connections must be so vented that the influence of sailplane speed and the opening and closing of windows, moisture or other foreign matter will not significantly affect the accuracy of the instruments.
- (b) The design and installation of a static pressure system must be such that:
 - (1) positive drainage of moisture is provided;

- (2) chafing of the tubing, and excessive distortion or restriction at bends in the tubing, is avoided; and
- (3) the materials used are durable, suitable for the purpose intended, and protected against corrosion.

CS 22.1327 Magnetic direction indicator

ED Decision 2003/13/RM

- (a) Each magnetic direction indicator required must be installed so that its accuracy is not excessively affected by the sailplane's vibration or magnetic fields.
- (b) The compensated installation must not have a deviation in level flight, greater than 10° on any heading, except that when radio is in use or the engine of a powered sailplane is running, the deviation may exceed 10° but must not exceed 15°.

CS 22.1337 Power-plant instruments

ED Decision 2003/13/RM

- (a) *Instruments and instrument lines*
 - (1) Each power-plant instrument line must meet the requirements of [CS 22.993](#).
 - (2) Each line carrying flammable fluids under pressure must have restricting orifices or other safety devices at the source of pressure to prevent the escape of excessive fluid if the line fails.
- (b) Each exposed sight gauge used as a fuel quantity indicator must be protected against damage.

ELECTRICAL SYSTEMS AND EQUIPMENT

CS 22.1353 Storage battery design and installation

ED Decision 2003/13/RM

- (a) Each storage battery must be designed and installed as prescribed in this paragraph.
- (b) No explosive or toxic gases emitted by any battery in normal operation, or as the result of any probable malfunction in the charging system or battery installation, may accumulate in hazardous quantities within the sailplane.
- (c) No corrosive fluids or gases that may escape from the battery may damage surrounding structures or adjacent essential equipment.

CS 22.1361 Master switch arrangement

ED Decision 2003/13/RM

- (a) In powered sailplanes there must be a master switch arrangement to allow ready disconnection of electric power sources from the main bus. The point of disconnection must be adjacent to the sources controlled by the switch.
- (b) The master switch or its controls must be so installed that the switch is easily discernible and accessible to the pilot.

CS 22.1365 Electric cables and equipment

ED Decision 2003/13/RM

- (a) Each electric connecting cable must be of adequate capacity and correctly routed, attached and connected so as to minimize the probability of short circuits and fire hazards.
- (b) Overload protection must be provided for each electrical equipment. No protective device may protect more than one circuit essential to flight safety.
- (c) Unless each cable installation from the battery to a circuit protective device or master switch, whichever is closer to the battery, is of such power-carrying capacity that no hazardous damage will occur in the event of a short circuit, this length of cable must be so protected or routed in relation to parts of the powered sailplane that the risk of short circuit is minimised.

AMC 22.1365(c) Electric cables and equipment

ED Decision 2003/13/RM

This is normally achieved by limiting unprotected battery to master switch cables, of an adequate capacity, to a maximum length of 0.5 m.

In any event the capacities of protected cables should be such that no hazardous damage will occur to the powered sailplane, nor ill effects to the occupants from the generation of noxious fumes, due to electrical overloading of cables before a circuit protective device will operate.

CS 22.1385 External lights

ED Decision 2003/13/RM

If external lights are to be installed they must be approved.

MISCELLANEOUS EQUIPMENT

CS 22.1431 ATC airborne equipment

ED Decision 2003/13/RM

Each ATC airborne equipment provided must comply with the following:

- (a) The equipment and its aerals may neither in themselves nor by their mode of operation or by their effect upon the operating characteristics of the sailplane and its equipment constitute a hazard to safe operation.
- (b) The equipment and its control and monitoring devices must be arranged so as to be easily controllable. Their installation must be such that they are sufficiently ventilated to prevent overheating.

CS 22.1441 Oxygen equipment and supply

ED Decision 2003/13/RM

- (a) Oxygen equipment must be approved.
- (b) Oxygen equipment must be free from hazards in itself, in its method of operation, and its effect upon other components.
- (c) There must be a means to allow the crew to readily determine, during the flight, the quantity of oxygen available in each source of supply.
- (d) Oxygen bottles must be installed so as not to be hazardous in crash landings.

CS 22.1449 Means for determining use of oxygen

ED Decision 2003/13/RM

There must be a means to allow the crew to determine whether oxygen is being delivered to the dispensing equipment.

SUBPART G — OPERATING LIMITATIONS AND INFORMATION

GENERAL

CS 22.1501 General

ED Decision 2003/13/RM

- (a) Each operating limitation specified in [CS 22.1505](#) through [CS 22.1525](#) and other limitations and information necessary for safe operation must be established.
- (b) The operating limitations and other information necessary for safe operation must be made available to the pilot as prescribed in [CS 22.1541](#) through [CS 22.1585](#).

CS 22.1505 Air-speed limitations

ED Decision 2003/13/RM

- (a) All flight speeds must be stated in terms of air-speed indicator readings (IAS).
- (b) The never exceed speed, V_{NE} , must not exceed 0.90 times the maximum speed demonstrated in flight tests (V_{DF}).
- (c) V_{DF} must not exceed the design maximum speed, V_D and must not be less than 0.9 times the design maximum speed according to [CS 22.335\(f\)](#).

AMC 22.1505(a) Air-speed limitation

ED Decision 2003/13/RM

Speeds (EAS) determined from structural limitations should be suitably converted.

CS 22.1507 Manoeuvring speed

ED Decision 2003/13/RM

The manoeuvring speed must not exceed the design manoeuvring speed, V_A as defined in [CS 22.335\(a\)](#).

CS 22.1511 Wing-flap operating speed

ED Decision 2003/13/RM

For each positive wing-flap position (see [AMC 22.335](#)), the maximum wing-flap operating speed V_{FE} must not be greater than 0.95 times the speed V_F as defined in [CS 22.335\(b\)](#) for which the structure has been designed.

CS 22.1513 Powerplant extension and retraction speed

ED Decision 2003/13/RM

The flight speed range for extension and retraction of the powerplant must be established, together with any limitations associated with it.

CS 22.1514 Powerplant extended maximum permitted speed

ED Decision 2003/13/RM

The powerplant extended maximum speed V_{PE} must be established as required by [CS 22.1149\(b\)](#) for powered sailplanes capable of extending and retracting the powerplant

CS 22.1515 Landing gear operating speed

ED Decision 2003/13/RM

The maximum landing gear operating speed V_{LO} , if lower than the never exceed speed V_{NE} , must be established for retractable landing gear. It may, however, not be lower than V_T or V_W , whichever is greater.

CS 22.1517 Rough air speed

ED Decision 2003/13/RM

The rough air speed, V_{RA} may not exceed the design gust speed in free flight V_B as defined in [CS 22.335\(c\)](#).

CS 22.1518 Aerotow and winch-launching speeds

ED Decision 2003/13/RM

- (a) The maximum aerotow speed may not exceed the design speed V_T established in accordance with [CS 22.335\(d\)](#) and may not exceed the speed demonstrated in flight tests.
- (b) The maximum winch-launch speed may not exceed the design speed V_W established in accordance with [CS 22.335\(e\)](#) and may not exceed the speed demonstrated in flight tests.

CS 22.1519 Weight and c.g.

ED Decision 2003/13/RM

- (a) The maximum weight determined under [CS 22.25\(a\)](#) must be established as an operating limitation.
- (b) The weight of non-lifting structural parts must be established.
- (c) The c.g. limitations determined under [CS 22.23](#) must be established as operating limitations.
- (d) The empty weight and the corresponding c.g. positions must be determined in accordance with [CS 22.29](#).

CS 22.1521 Power-plant limitations

ED Decision 2003/13/RM

- (a) *General.* The power-plant limitations prescribed in this paragraph must be established so that they do not exceed the corresponding limits for which the engine or propeller is type certificated.
- (b) *Take-off and continuous operation.* The take-off and continuous operation must be limited by:
 - (1) the maximum rotational speeds (r.p.m.);
 - (2) the time limit for the use of take-off power;
 - (3) the maximum allowable cylinder head, oil, and liquid coolant temperatures, as appropriate; and

- (4) the maximum allowable manifold pressure or any other parameter limiting the engine power if the engine is equipped with a continuously variable pitch propeller.

CS 22.1523 Solo flight operation

ED Decision 2003/13/RM

The pilot's seat for solo flight must be designated so that it is appropriate for safe operation, considering the accessibility of the controls that must be used by the solo pilot during all normal and emergency operations, when the pilot is seated at the designated seat station.

CS 22.1525 Kinds of operation

ED Decision 2003/13/RM

The kinds of operation to which the sailplane is limited are established by the category in which it is eligible for certification and by the installed equipment.

CS 22.1529 Maintenance manual

ED Decision 2003/13/RM

A maintenance manual containing the information that the applicant considers essential for proper maintenance must be provided. The following must at least be considered in developing the essential information:

- (a) description of systems;
- (b) lubrication instructions setting forth the frequency and the lubricants and fluids which are to be used in the various systems;
- (c) pressures and electrical loads applicable to the various systems;
- (d) tolerances and adjustments necessary for proper functioning of the sailplane;
- (e) methods of levelling, raising and ground towing;
- (f) methods of balancing control surfaces, and maximum permissible values of play at hinge pins and control circuit backlash;
- (g) allowed rigging tension in the cables of cable-operated control systems, as established according to [CS 22.411\(b\)](#);
- (h) identification of primary and secondary structures;
- (i) frequency and extent of inspections necessary for proper maintenance of the sailplane;
- (j) special repair methods applicable to the sailplane;
- (k) special inspection techniques;
- (l) list of special tools;
- (m) rigging data necessary for the proper operation of the sailplane;
- (n) a separate section titled Airworthiness Limitations, segregated and clearly distinguishable from the rest of the document, containing statement of service life limitations, replacement or mandatory overhaul of parts, components and accessories subject to such limitations and structural inspection intervals. Those limitations which are given in documents referred to in (o) must be referenced;

- (o) list of maintenance documents for parts, components and accessories approved independently of the sailplane;
- (p) the materials necessary for small repairs;
- (q) care and cleaning recommendations;
- (r) instructions for rigging and de-rigging;
- (s) information on supporting points for ground transport;
- (t) list of placards and markings and their locations.

MARKINGS AND PLACARDS

CS 22.1541 General

ED Decision 2003/13/RM

- (a) The sailplane must contain –
 - (1) the markings and placards specified in [CS 22.1545](#) through CS 22.1567; and
 - (2) any additional information, instrument markings, and placards required for the safe operation if it has unusual design, operating, or handling characteristics.
- (b) Each marking and placard prescribed in sub-paragraph (a) of this paragraph –
 - (1) must be displayed in a conspicuous place; and
 - (2) may not be easily erased, disfigured, or obscured.
- (c) The units of measurement used to indicate air speed on placards must be the same as those used on the indicator.

CS 22.1543 Instrument markings – general

ED Decision 2003/13/RM

For each instrument:

- (a) when markings are on the cover glass of the instrument, there must be means to maintain the correct alignment of the glass cover with the face of the dial; and
- (b) each arc and line must be wide enough and located to be clearly visible to the pilot and not mask any portion of the dial.

CS 22.1545 Air-speed indicator

ED Decision 2003/13/RM

Each air-speed indicator must show the following markings:

- (a) For V_{NE} , a radial red line. If V_{NE} varies with altitude, there must be a means to indicate to the pilot the appropriate limitations throughout the operating altitude range. (See [AMC 22.1545\(a\)](#))
- (b) for the upper caution range a yellow arc extending from V_{NE} to the allowable rough-air speed V_{RA} ;
- (c) for the normal operating range, a green arc with the lower limit at $1.1 V_{S1}$ with maximum weight and for wing-flaps neutral (see [AMC 22.335](#)) and landing gear retracted and the upper limit at the rough-air speed V_{RA} ;
- (d) for the wing-flap operating range, a white arc with the lower limit at the stall speed $1.1 V_{S0}$ for maximum weight and the upper limit at the allowable wing-flaps extended speed V_{FE} ;
- (e) a yellow marking (triangle) for the lowest approach speed (at maximum weight without water ballast) recommended by the manufacturer;
- (f) for the best rate-of-climb speed V_Y a blue radial line (for powered sailplanes only). service.

AMC 22.1545(a) Air-speed indicator

ED Decision 2003/13/RM

A placard located close to, or suitable markings on the face of, the airspeed indicator, giving reductions of V_{NE} with altitude, are acceptable means of compliance with the second sentence of this paragraph.

AMC 22.1545 Air-speed indicator

ED Decision 2003/13/RM

An example of the presentation of an air-speed indicator complying with this requirement is shown in Figure 1.

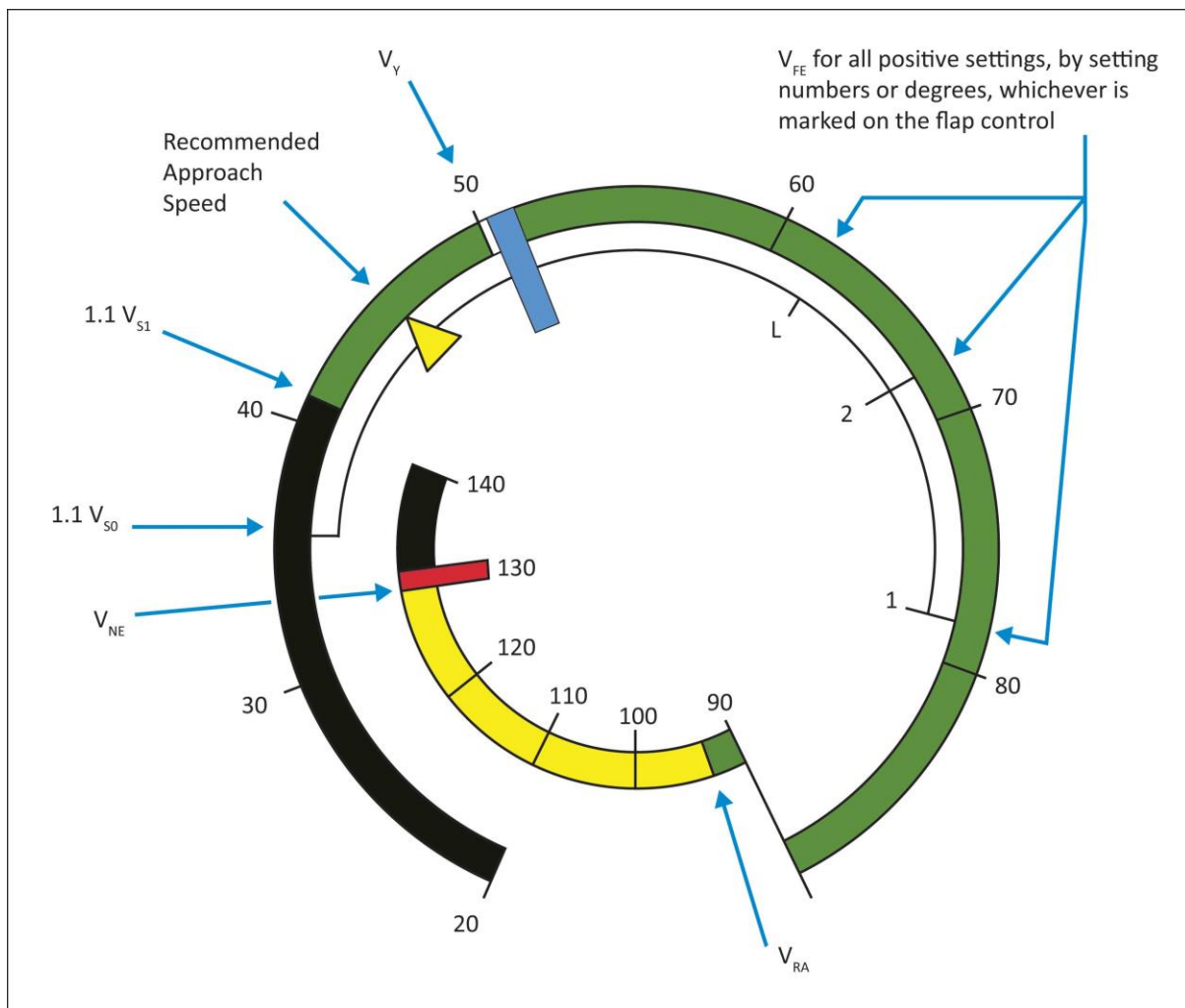

Figure 1 EXAMPLE OF AIR SPEED INDICATOR MARKINGS

CS 22.1547 Magnetic direction indicator

ED Decision 2003/13/RM

Unless the deviation is less than 5° on all headings, the deviation values for magnetic headings in not more than 30° increments must be placarded near the magnetic direction indicator.

CS 22.1548 Accelerometer

ED Decision 2003/13/RM

Each accelerometer required by [CS 22.1303\(c\)](#) must show red radial lines for the maximum positive and negative limit manoeuvring load factors.

CS 22.1549 Power-plant instruments

ED Decision 2003/13/RM

For each required power-plant instrument, as appropriate to the type of instruments:

- (a) each maximum and, if applicable, minimum safe operating limit must be marked with a red radial line;
- (b) each normal operating range must be marked with a green arc, not extending beyond the maximum and minimum safe limits;
- (c) each take-off and precautionary range must be marked with a yellow arc.
- (d) in the case of digital solid state displays, limitations, precautionary and operating ranges required by sub-paragraphs (a), (b) and (c) of this paragraph must be clearly indicated. The display must be readable under all lighting conditions likely to be met in service.

AMC 22.1549(d) Power-plant instruments

ED Decision 2003/13/RM

In the case of digital solid state displays the required red line should be represented by a steady red light near or on the instrument, or by blinking of the whole display. The precautionary range should be indicated near or on the instrument. All instrument indications in that range should be designed to obtain the attention of the pilot. In addition, the operating range data should be placarded near the display using the colours described in [CS 22.1549\(a\), \(b\) and \(c\)](#).

Oil temperature, oil pressure and cylinder head temperature indications will be acceptable if achieved by means of warning lights instead of analogue or digital indications if:

- (1) The required red line is represented by a steady red light.
- (2) The normal operating range is represented by a steady green light.
- (3) The precautionary range is represented by a steady yellow light.
- (4) A 'press to test' facility is provided for the warning light displays.

CS 22.1553 Fuel quantity indicator

ED Decision 2003/13/RM

Each fuel quantity indicator must be calibrated to read 'zero' during level flight when the quantity of fuel remaining in the tank is equal to the unusable quantity determined in accordance with [CS 22.959](#).

CS 22.1555 Control markings

ED Decision 2003/13/RM

- (a) Each cockpit control, other than primary flight controls, must be clearly marked as to its function and method of operation.
- (b) The colour markings of cockpit controls must be in accordance with those specified in [CS 22.780](#).

- (c) for power-plant fuel controls:
- (1) Each fuel tank selector control must be marked to indicate the position corresponding to each tank.
 - (2) If safe operation requires the use of any tanks in a specific sequence, that sequence must be marked on or near the selector for those tanks.

AMC 22.1555(a) Control markings

ED Decision 2003/13/RM

Identification of the controls should consist of easily understandable and commonly used symbols, such as those shown in CS-22, Book 1, [Appendix G](#), in preference to placards.

Appendix G – Cockpit placards

ED Decision 2003/13/RM

1 FLAPS

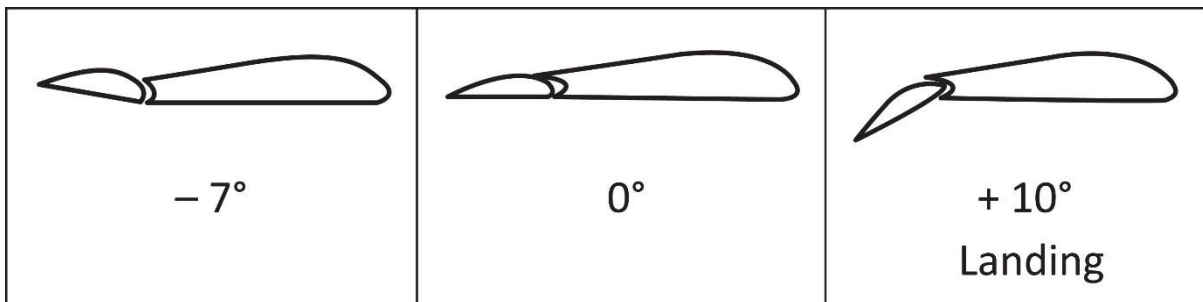

2 AIR BRAKES

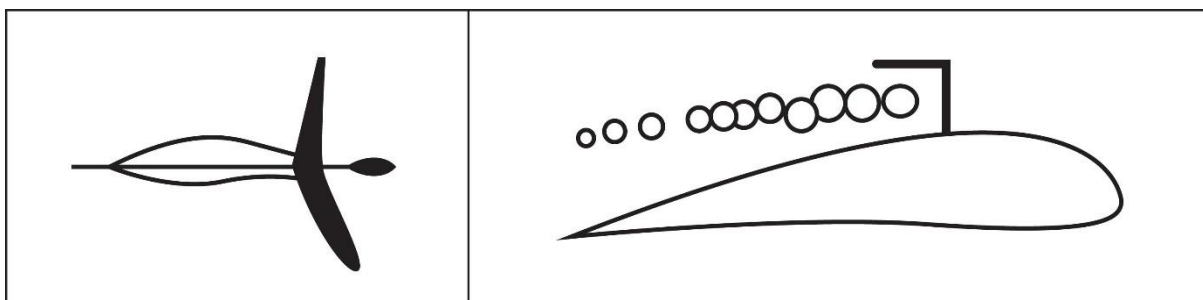

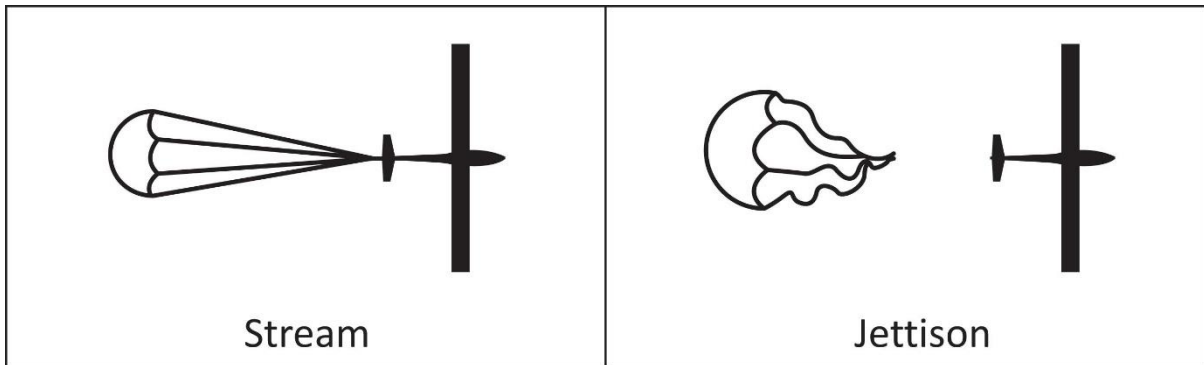
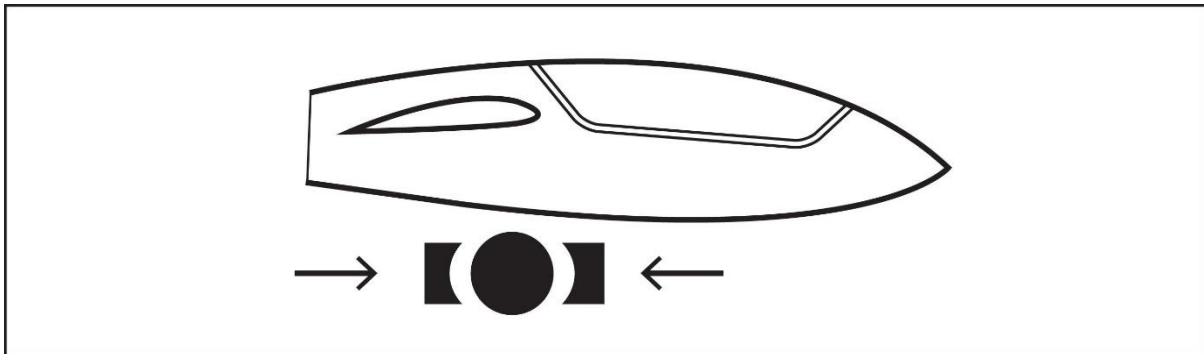
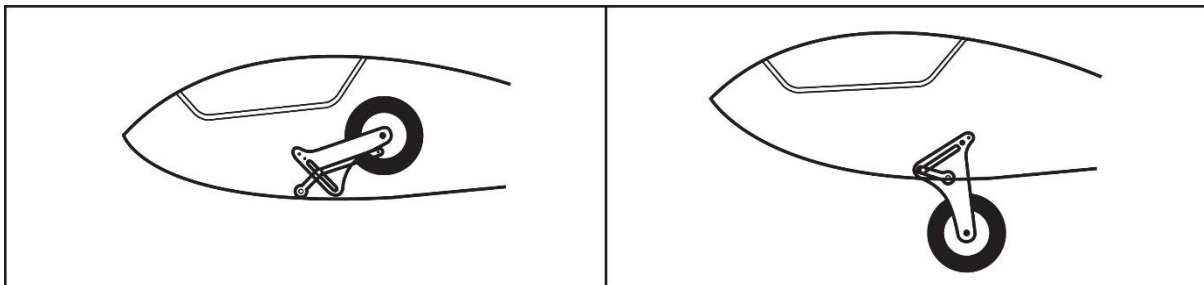
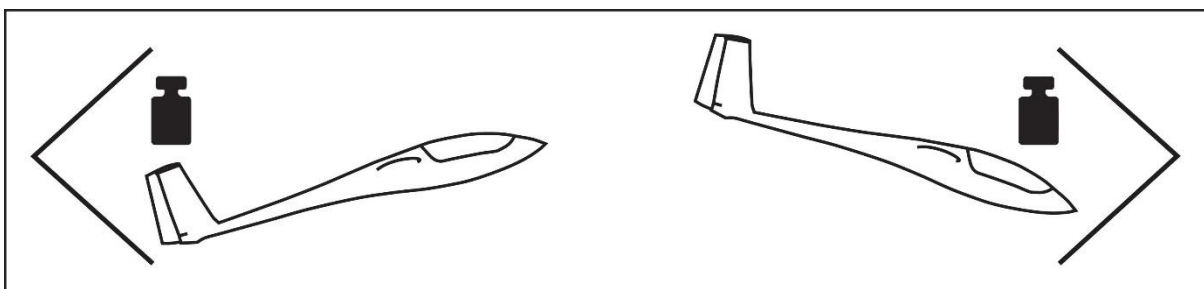
3 BRAKE CHUTE**4 WHEEL BRAKE****5 LANDING GEAR****6 TRIMMER**

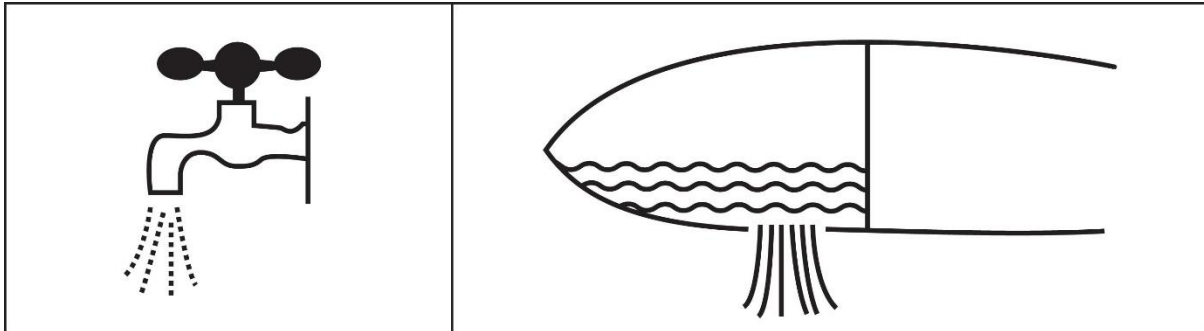
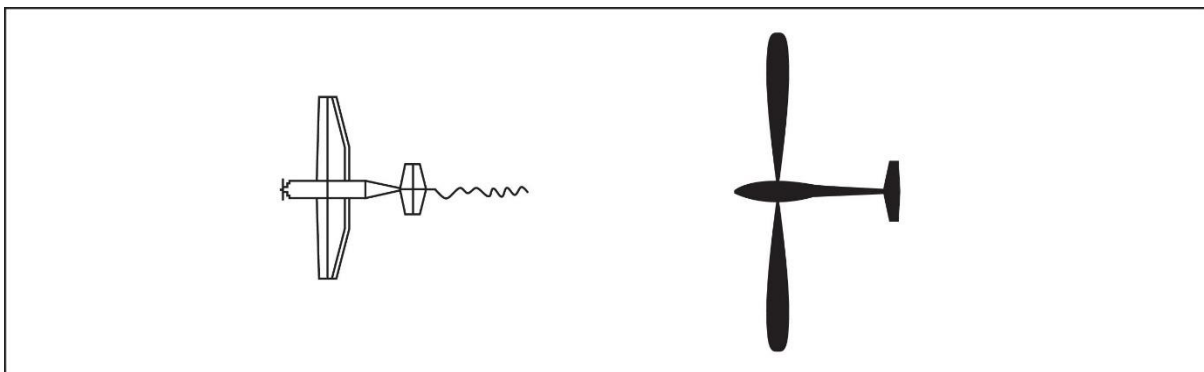
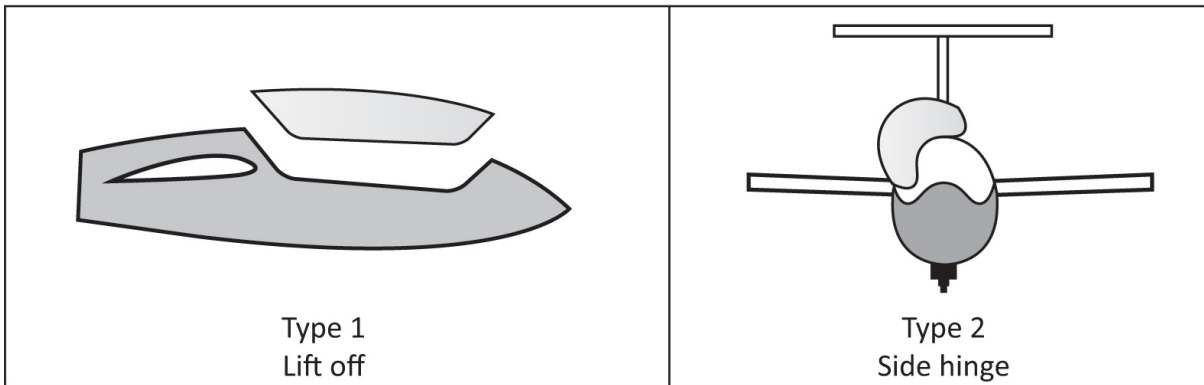
7 WATER BALLAST**8 RELEASE****9 CANOPY**

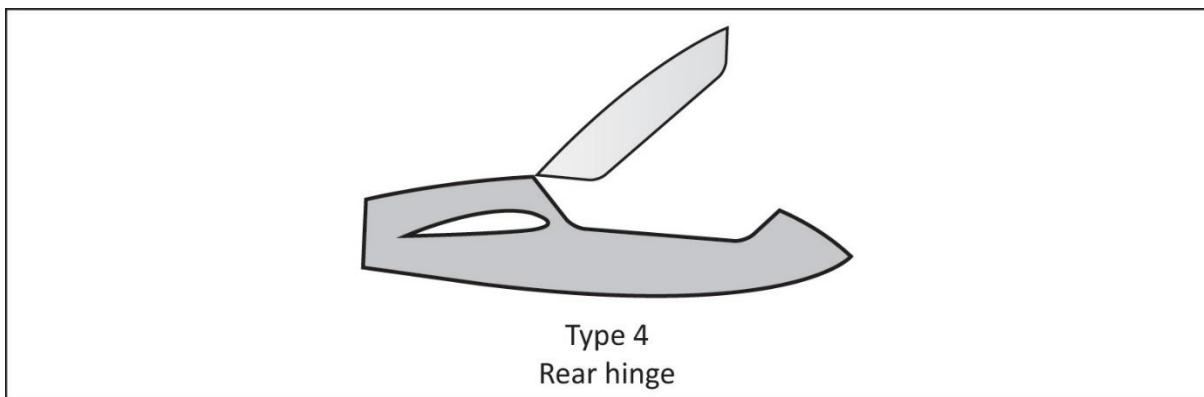
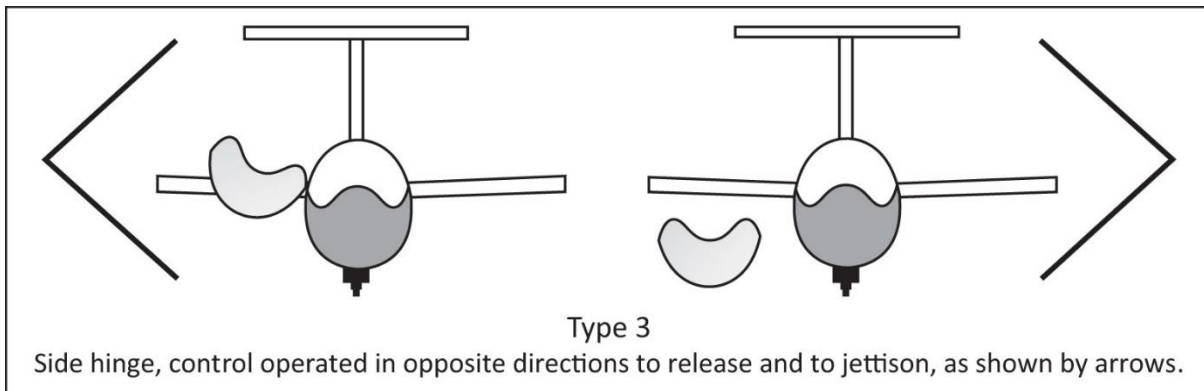

10 SEAT BACK

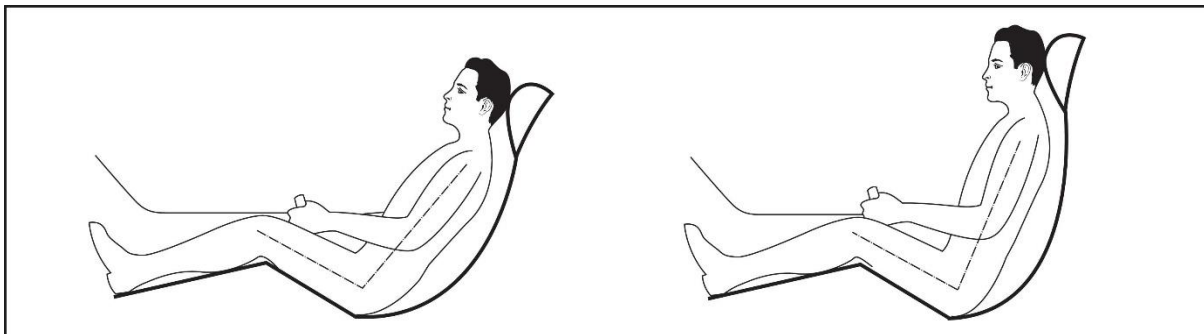

11 PEDAL ADJUST

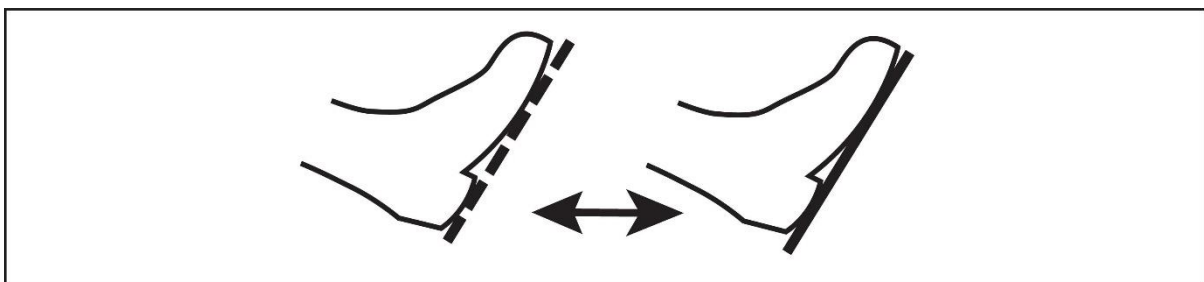

12 AIR VENT

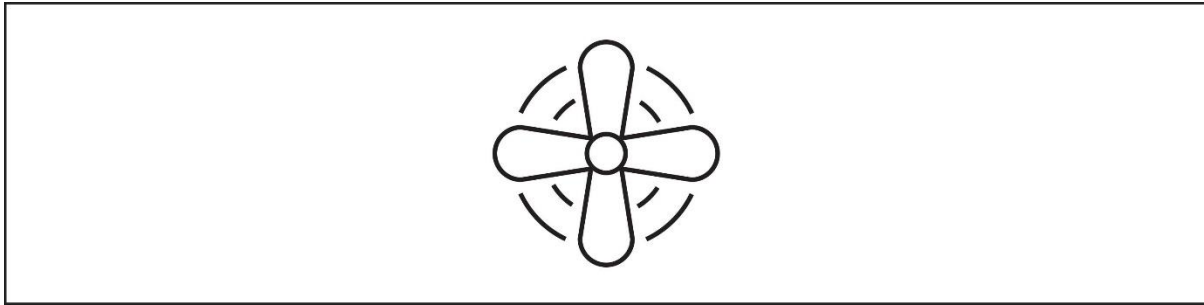

CS 22.1557 Miscellaneous marking and placards

ED Decision 2003/13/RM

- (a) *Baggage compartment.* Each baggage compartment must have a placard stating the loading limitations.
- (b) *Fuel and oil filler openings.* The following apply:
 - (1) Fuel filler openings must be marked at or near the filler cover with the minimum fuel grade.
 - (2) Oil filler openings must be marked at or near the filler cover:
 - (i) with the grade; and
 - (ii) if the oil is detergent or nondetergent.
- (c) *Fuel tanks.* The usable fuel capacity of each tank must be marked either at the selector or on the gauge (when provided) or on the tank if this is translucent and visible to the pilot in flight.
- (d) *In-flight engine starting.* A placard must be provided stating any limitations to be observed during in-flight engine starting.
- (e) *Tyre pressure.* In the case of sailplanes fitted with a landing wheel or wheels, the tyre pressure must be marked on or in the sailplane.
- (f) *Aerobatic manoeuvres.* A list of permissible aerobatic manoeuvres, including spins, must be placarded in each sailplane, so that it is plainly visible to the pilot.
- (g) *Removable ballast.* If removable ballast is used, the place for carrying ballast must have a placard stating instructions for the proper placement of the removable ballast under each loading condition for which each removable ballast is necessary.
- (h) *Weight and cockpit load.* The following additional data must be placarded in each sailplane so that they are plainly visible to the pilot:
 - (1) maximum weight.
 - (2) maximum and minimum cockpit weight.

CS 22.1561 Safety equipment

ED Decision 2003/13/RM

Each attachment point for an occupant's parachute static line must be marked red.

CS 22.1563 Airspeed placards

ED Decision 2003/13/RM

The following speeds, if they are not marked on the air-speed indicator, must be placarded in each sailplane or powered sailplane so that they are plainly visible to the pilot:

- (a) the maximum winch-launching speed, V_W (when winch-launching is allowed);
- (b) the maximum aerotow speed, V_T (when aerotow is allowed);
- (c) the manoeuvring speed;
- (d) the maximum landing gear operating speed, V_{LO} , where applicable;
- (e) the powerplant extension and retraction speeds $V_{PO \text{ min}}$ and $V_{PO \text{ max}}$, where applicable.

FLIGHT MANUAL

CS 22.1581 General

ED Decision 2003/13/RM

- (a) *Furnishing Information.* A Flight Manual must be furnished with each sailplane. There must be an appropriate location for stowage of the Flight Manual aboard the sailplane and each Flight Manual must contain the following:
- (1) Information required in [CS 22.1583](#) through [CS 22.1589](#) including the explanations necessary for their proper use and the significance of the symbols used.
 - (2) Other information that is necessary for safe operation because of design, operating or handling characteristics.
 - (3) A list of effective pages, with identification of those containing approved information according to sub-paragraph (b).
- (b) *Approved information.* Each part of the Flight Manual containing information prescribed in [CS 22.1583](#) through [CS 22.1587\(a\)](#) must be limited to such information and must be approved, identified, and clearly distinguished from each other part of the Flight Manual. All manual material must be of a type that is not easily erased, disfigured, or misplaced and it must be in the form of individual sheets capable of being inserted in a manual provided by the applicant, or in a folder, or in any other permanent form.
- (c) *Units.* The units of measurement used in the Flight Manual must be the same as those used on the indicators.

AMC 22.1581 Flight manual

ED Decision 2003/13/RM

General

An acceptable format for a Flight Manual is given on the next pages.

SPECIMEN FLIGHT MANUAL FOR A SAILPLANE (INCLUDING A POWERED SAILPLANE)

Model:

Serial No:

Registration:

Document No. (If appropriate):

Date of Issue:

Pages identified by 'Appr.' are approved by:

Signature:

Agency:

Stamp:

Original date of approval:

This sailplane is to be operated in compliance with information and limitations contained herein.

(Model Designation or Document No.)**0.1 Record of revisions**

Any revision of the present manual, except actual weighing data, must be recorded in the following table and in case of approved Sections endorsed by the Agency.

The new or amended text in the revised page will be indicated by a black vertical line in the left hand margin, and the Revision No. and the date will be shown on the bottom left hand of the page.

Rev. No.	Affected Section	Affected Pages	Date of Issue	Approval	Date of approval	Date of Insertion	Signature

(i)

(Model Designation or Document No.)

0.2 List of Effective Pages

Section	Page	Date of Issue	Section	Page	Date of Issue
0	(i) (ii) (iii)				
1	1.1 1.2 1.3				
2	2.1 Appr. 2.2 Appr. 2.3 Appr. 2.4 Appr. 2.5				
3 etc.	3.1 Appr. 3.2				

(ii)

(Model Designation or Document No.)**0.3 Table of Contents**

	Section
General (a non-approved section)	1
Limitations (an approved section)	2
Emergency procedures (an approved section)	3
Normal procedures (an approved section)	4
Performance (a partly approved section)	5
Weight and balance/equipment list (a non-approved section)	6
Sailplane and systems description (a non-approved section)	7
Sailplane handling, care and maintenance (a non-approved section)	8
Supplements	9

(iii)

(Model Designation or Document No.)**Section 1**

1. General
 - 1.1 Introduction
 - 1.2 Certification basis
 - 1.3 Warnings, cautions and notes
 - 1.4 Descriptive data
 - 1.5 Three-view drawing

1.1

(Model Designation or Document No.)

1.1 *Introduction*

The sailplane flight manual has been prepared to provide pilots and instructors with information for the safe and efficient operation of the sailplane.

This manual includes the material required to be furnished to the pilot by CS-22. It also contains supplemental data.

1.2 *Certification basis*

This type of sailplane has been approved by (Agency) in accordance with CS-22 including Amendment and the Type Certificate No. has been issued on (date) Category of Airworthiness (Utility, Aerobatic) Noise Certification Basis.....

1.3 *Warnings, cautions and notes*

The following definitions apply to warnings, cautions and notes used in the flight manual.

WARNING: means that the non-observation of the corresponding procedure leads to an immediate or important degradation of the flight safety.

CAUTION: means that the non-observation of the corresponding procedure leads to a minor or to a more or less long term degradation of the flight safety.

NOTE: draws the attention on any special item not directly related to safety but which is important or unusual.

1.4 *Descriptive data*

(Kind of sailplane or powered sailplane)

(Design details)

(Engine and propeller)

(Span, length, height, MAC, wing area, wing loading)

(Model Designation or Document No.)

1.5 *Three-view drawing*

1.3

(Model Designation or Document No.)**Section 2**

- 2. Limitations
 - 2.1 Introduction
 - 2.2 Airspeed
 - 2.3 Airspeed indicator markings
 - 2.4 Power-plant, fuel and oil
 - 2.5 Power-plant instrument markings
 - 2.6 Weight
 - 2.7 Centre of gravity
 - 2.8 Approved manoeuvres
 - 2.9 Manoeuvring load factors
 - 2.10 Flight crew
 - 2.11 Kinds of operation
 - 2.12 Minimum equipment
 - 2.13 Aerotow and winch- and autotow-launching
 - 2.14 Other limitations
 - 2.15 Limitations placards

2.1

(Model Designation or Document No.)

2.1 Introduction

Section 2 includes operating limitations, instrument markings, and basic placards necessary for safe operation of the sailplane, its engine, standard systems and standard equipment.

The limitations included in this section and in Section 9 have been approved by (Agency).

2.2 Airspeed

Airspeed limitations and their operational significance are shown below:

	Speed	(IAS)	Remarks
V _{NE}	Never exceed speed		Do not exceed this speed in any operation and do not use more than 1/3 of control deflection
V _{RA}	Rough air speed		Do not exceed this speed except in smooth air, and then only with caution. Examples of rough air are lee-wave rotor, thunderclouds etc.
V _A	Manoeuvring speed		Do not make full or abrupt control movement above this speed, because under certain conditions the sailplane may be overstressed by full control movement.
V _{FE}	Maximum Flap Extended speed (if applicable give different flap settings)		Do not exceed these speeds with the given flap setting.
V _W	Maximum winch-launching speed		Do not exceed this speed during winch- or autotow-launching
V _T	Maximum aerotowing speed		Do not exceed this speed during aerotowing
V _{LO}	Maximum landing gear operating speed		Do not extend or retract the landing gear above this speed
V _{POmax}	Maximum powerplant extension and retraction speed		Do not extend or retract the retractable powerplant outside of this speed range
V _{POmin}	Minimum powerplant extension and retraction speed		
V _{PE}	Powerplant extended maximum permitted speed		Do not exceed this speed with the powerplant extended.

(If further speed limitations are required they must be added hereon).

Appr. 2.2

(Model Designation or Document No.)

2.3 Airspeed indicator Markings

Airspeed indicator markings and their colour- code significance are shown below:

Marking	(IAS) value or range	Significance
White arc		<i>Positive Flap Operating Range.</i> (Lower limit is 1.1 V_{S0} in landing configuration at maximum weight. Upper limit is maximum speed permissible with flaps extended positive)
Green arc		<i>Normal Operating Range.</i> (Lower limit is 1.1 V_{S1} at maximum weight and most forward c. g. with flaps neutral. Upper limit is rough air speed)
Yellow arc		Manoeuvres must be conducted with caution and only in smooth air
Red line		Maximum speed for all operations
Blue line		Best rate-of-climb speed V_Y
Yellow triangle		Approach speed at maximum weight without water ballast

2.4 Power-plant, fuel and oil

Engine Manufacturer:

Engine Model:

Maximum Power, Take- off:

Continuous:

Maximum Engine rpm at MSL, Take-off:

Continuous:

Maximum Cylinder Head Temperature:

Maximum Oil Temperature:

Oil Pressure, Minimum:

Maximum:

Fuel (specification):

Oil grade (specification):

(if applicable: Fuel-oil mixture specification)

Propeller manufacturer:

Propeller model:

Appr. 2.3

(Model Designation or Document No.)

2.5 Power-plant instrument markings

Power-plant instrument markings and their colour-code significance are shown below:

Instrument	Red Line Minimum Limit	Green Arc Normal Operating	Yellow Arc Caution Range	Red Line Maximum Limit
Tachometer	---	(range)	(range)	
Oil temperature	---		---	
Cylinder head temperature	---		---	
Oil pressure			---	
Fuel quantity	(unusable fuel mark)	---	---	---

Appr. 2.4

(Model Designation or Document No.)

2.6 *Mass (weight)*

Maximum take-off mass:

(with water ballast)

(without water ballast)

Maximum landing mass:

Maximum mass of all non-lifting parts:

Maximum mass in baggage compartment:

2.7 *Centre of gravity*

Centre of gravity range (for flight)

A table of c.g. ranges at different empty weights

Reference datum

2.8 *Approved manoeuvres*

This sailplane is certified in the category.

(If aerobatic figures are approved, they must be listed herein with reference to Section 4 for recommended entry speeds).

2.9 *Manoeuvring load factors*

(Maximum positive and negative load factors under different conditions must be listed herein).

2.10 *Flight crew*

(In the case of a two-seater the limitations for solo flights must be given herein).

2.11 *Kinds of operation*

(Herein must be listed the approved kinds of operation according to [CS 22.1525](#)).

2.12 *Minimum equipment*

(Herein must be listed the minimum equipment such as airspeed indicator, altimeter, compass etc. required for normal cross-country flights and the required additional equipment for cloud flying or aerobatic flights, if applicable).

2.13 *Aerotow and winch- and autotow-launching*

(Herein must be listed the approved towing speeds, the towing cable or weak link strength and the minimum cable length).

Appr. 2.5

(Model Designation or Document No.)**2.14 Other limitations**

(Provide a statement of any limitation required by [CS 22.1581\(c\)](#), but not specifically covered in this Section).

Intentional manoeuvres not approved with water ballast, or limitations associated with asymmetric water ballast conditions must be listed.

Weight and Balance control procedures for in flight C.G. control must be stated if necessary.

The time required to jettison the water ballast.

Any approved water ballast additives, proportions to be used and any associated temperature and/or time limitations.

Any outside temperature/time limitation associated with the carriage of water ballast.

2.15 Limitations placard

(The operating limitations placard required in CS 22.1559 must be illustrated).

Water ballast jettison time.

Note: For further placards refer to Maintenance Manual Doc. No....

Appr. 2.6

(Model Designation or Document No.)

Section 3

- 3. Emergency procedures
 - 3.1 Introduction
 - 3.2 Canopy jettison
 - 3.3 Bailing out
 - 3.4 Stall recovery
 - 3.5 Spin recovery
 - 3.6 Spiral dive recovery
 - 3.7 Engine failure (carburettor icing)
 - 3.8 Fire
 - 3.9 Other emergencies

3.1

(Model Designation or Document No.)

3.1 *Introduction*

Section 3 provides checklist and amplified procedures for coping with emergencies that may occur.

3.2 *Canopy jettison*

(Procedures must be provided for jettisoning the canopy in an emergency).

3.3 *Bailing out*

(Procedures must be provided for safely getting out and clear of the sailplane).

3.4 *Stall recovery*

(The stall recovery procedure must be explained).

3.5 *Spin recovery*

(The recovery procedure from an unintentional spin must be explained. A statement must be included that the sailplane is not, or not in all configurations, approved for spins. If applicable, the influence of water-ballast should be taken into account).

3.6 *Spiral dive recovery*

(The recovery procedure from a spiral dive must be explained. The influence of water-ballast should be taken into account).

3.7 *Engine failure*

(Procedures must be provided for all cases of engine failure during take-off and flight, for powered sailplanes only).

3.8 *Fire*

(Procedures must be provided for coping with cases of smoke or fire in the cockpit or in the engine compartment in the following flight phases:

- (a) on the ground
- (b) during take-off
- (c) in flight).

3.9 *Other emergencies*

(Emergency procedures and other pertinent information necessary for safe operations must be provided for emergencies peculiar to a particular sailplane design, operating or handling characteristics. Continued safe take-off, flight and landing procedures for any malfunction which can cause an asymmetric flight condition must be described in the emergency section of the flight manual).

Appr. 3.2

(Model Designation or Document No.)**Section 4**

- 4. Normal procedures
 - 4.1 Introduction
 - 4.2 Rigging and de-rigging
 - 4.3 Daily inspection
 - 4.4 Pre-flight inspection
 - 4.5 Normal procedures and recommended speeds
 - 4.5.1 Launch/engine starting, run up, taxiing procedures
 - 4.5.2 Take-off and climb
 - 4.5.3 Flight (including inflight engine stop/start procedures)
 - 4.5.4 Approach
 - 4.5.5 Landing
 - 4.5.6 Flight with water ballast
 - 4.5.7 High altitude flight
 - 4.5.8 Flight in rain
 - 4.5.9 Aerobatics

4.1

(Model Designation or Document No.)

4.1 Introduction

Section 4 provides checklists and amplified procedures for the conduct of normal operation. Normal procedures associated with optional systems can be found in Section 9.

4.2 Rigging and de-rigging.

(The procedure for rigging and de-rigging must be explained. Special attention must be drawn to connections to be made in the control systems and the attachment points of wings and empennage).

4.3 Daily inspection

(The recommended daily inspection must be explained)

(Note: The daily inspection could be continued in the Maintenance Manual but should primarily be in the Flight Manual, as it is related to pilot activity).

4.4 Pre-flight inspection

(The recommended pre-flight inspection must be explained. Special attention must be drawn to connections in the control systems and the attachment points of wing and empennage).

4.5 Normal procedures and recommended speeds

(This chapter must contain the recommended normal procedures for the phases listed under 4.5.1 through 4.5.9 and the recommended air speeds, if applicable.

If take-off, flight and landing characteristics are different in rain this should be specially stated herein.

Under 4.5.3 must be noted that flights in conditions conducive to lightning strikes must be avoided, unless the sailplane is approved for lightning strike conditions.

Water ballast tank filling, draining and jettisoning procedure(s) must be described.

Description of continued safe take-off, flight and landing procedures with partial or full water ballast).

Appr. 4.2

(Model Designation or Document No.)**Section 5**

- 5. Performance
 - 5.1 Introduction
 - 5.2 Approved data
 - 5.2.1 Airspeed indicator system calibration
 - 5.2.2 Stall speeds
 - 5.2.3 Take-off performance
 - 5.2.4 Additional information
 - 5.3 Non-approved further information
 - 5.3.1 Demonstrated crosswind performance
 - 5.3.2 Flight polar
 - 5.3.3 Noise data (for powered sailplanes only)

5.1

(Model Designation or Document No.)**5.1 Introduction**

Section 5 provides approved data for airspeed calibration, stall speeds and take-off performance and non-approved further information.

The data in the charts has been computed from actual flight tests with the sailplane and engine in good condition and using average piloting techniques.

5.2 Approved data**5.2.1 Airspeed indicator system calibration**

(The data must be presented as Calibrated Airspeed (CAS) versus Indicated Airspeed (IAS) assuming zero instrument error. The presentation should include all flap setting configurations and should cover the appropriate speed operating range).

5.2.2 Stall speeds

(The data must be presented as indicated airspeed versus flap setting configurations and angle of bank at maximum weight with and without water-ballast; in case of a powered sailplane, with throttle closed.

Altitude loss of more than 30m and pitch below the horizon of more than 30 degrees during recovery from stalls should be added, if applicable).

5.2.3 Take-off performance

(For powered sailplanes take-off distances).

5.2.4 Additional Information (Information must be provided according to [CS 22.1581\(c\)](#))**5.3 Non-approved further information** (In this section further information should be presented as follows:)**5.3.1 Demonstrated crosswind performance**

(The maximum crosswind velocity at which take-offs and landings have been demonstrated should be presented together with the launching methods used).

5.3.2 Flight polar

(For sailplanes the rate-of-descent versus flight speed should be presented, including minimum descent speed and best angle of glide speed.

For powered sailplanes additional data should be presented as endurance time versus altitude for various power settings and at least a full fuel loading with the engine running all the time).

5.3.3 Noise data (for powered sailplanes only)

(The certificated noise data must be presented).

Appr. 5.2

(Model Designation or Document No.)

Section 6

- 6. Weight and balance
 - 6.1 Introduction
 - 6.2 Weight and Balance Record and permitted payload-range

6.1

(Model Designation or Document No.)**6.1 Introduction**

This Section contains the payload range within which the sailplane may be safely operated.

Procedures for weighing the sailplane and the calculation method for establishing the permitted payload range and a comprehensive list of all equipment available for this sailplane and the installed equipment during the weighing of the sailplane are contained in the applicable Maintenance Manual Doc. No.

6.2

(Model Designation or Document No.)

6.2 Weight and Balance Record/permitted payload range

valid for Serial No

Date	Empty weight	c/g Pos.	Permitted pilot weight				Approved	
			with water-ballast		without water-ballast		Date	Signed
			Max.	Min.	Max.	Min.		

Example for a single seater

For calculation of the permitted max. and min. pilot weight refer to Maintenance Manual Doc. No.
 (The influence of fuel and water-ballast must be furnished)

valid for Serial No

Date	Empty Weight	c/g. pos.	Permitted crew + passenger weight with:												Approved		
			Max. baggage ... kg				Half baggage ... kg				No baggage				Date	Signed	
			Front seat		Rear seat		Front seat		Rear seat		Front seat		Rear seat				
			Max.	Min.	Max.	Min.	Max.	Min.	Max.	Min.	Max.	Min.	Max.	Min.			

Example for a tandem seater

For calculation of the max. and min. crew + passenger weight refer to Maintenance Manual Doc. No.....

(Model Designation or Document No.)**Section 7**

Note: The following is an example of items which may be included in this Section.

Duplication of information is not necessary and should be avoided.

- 7. General sailplane and systems description
 - 7.1 Introduction
 - 7.2 Cockpit controls
 - 7.3 Instrument panel
 - 7.4 Landing gear system
 - 7.5 Seats and safety harness
 - 7.6 Pitot and static system
 - 7.7 Air brake system
 - 7.8 Baggage Compartment
 - 7.9 Water ballast system
 - 7.10 Powerplant
 - 7.11 Fuel system
 - 7.12 Electrical system
 - 7.13 Miscellaneous equipment

7.1

(Model Designation or Document No.)**7.1 Introduction**

This Section provides description and operation of the sailplane and its systems. Refer to Section 9, Supplements, for details of optional systems and equipment.

7.2 Cockpit controls

(Describe the arrangement of the cockpit controls and their operating functions).

7.3 Instrument panel

(Provide a drawing or picture of the instrument panel. Identify the instruments, lights switches, circuit breakers and warning lights installed on the panel or in the cockpit).

7.4 Landing gear system

(Describe the system and explain the use of it).

7.5 Seats and safety harness

(Describe the adjustment of the seats, if applicable, and the safety harness installed).

7.6 Pilot and static system

(Describe the system with a good schematic).

7.7 Airbrake System

(Describe the kind of the system; airbrakes, flaps or brake-chutes and explain the use of it, if necessary).

7.8 Baggage compartment

(Describe location and tie-down provisions. Explain restrictions regarding weight and kind of baggage).

7.9 Water-ballast system

(Describe the system with a good schematic and explain the operation and anti-freeze recommendation).

7.10 Powerplant

(Describe the engine, the engine controls and instrumentation. Describe the propeller and explain how the propeller should operate).

7.11 Fuel System

(Describe the system with a good schematic and explain the operation. Explain unusable fuel. Explain the fuel measuring system and the fuel venting system. Explain the fuel/oil mixing method).

7.12 Electrical system

(Describe the system by use of simplified schematics. Explain how this system operates including warning and control devices. Explain circuit protections. Discuss battery capacity and load shedding).

7.13 Miscellaneous equipment

(Describe important equipment not already covered).

(Model Designation or Document No.)

Section 8

- 8. Sailplane handling, care and maintenance
 - 8.1 Introduction
 - 8.2 Sailplane inspection periods
 - 8.3 Sailplane alterations or repairs
 - 8.4 Ground handling/road transport
 - 8.5 Cleaning and care

8.1

(Model Designation or Document No.)

8.1 *Introduction*

This Section contains manufacturer's recommended procedures for proper ground handling and servicing of the sailplane. It also identifies certain inspection and maintenance requirements which must be followed if the sailplane is to retain that new-plane performance and dependability. It is wise to follow a planned schedule of lubrication and preventive maintenance based on climatic and flying conditions encountered.

8.2 *Sailplane inspection period*

(Reference to Maintenance Manual of the (powered) sailplane)

8.3 *Sailplane alterations or repairs*

It is essential that the Agency be contacted prior to any alterations on the sailplane to ensure that the airworthiness of the sailplane is not compromised.

For repairs refer to the applicable Maintenance Manual Doc. No.....

8.4 *Ground handling / road transport*

(Describe the carrying and lifting provisions for the sailplane. Explain the following procedures, if applicable:

- (a) Towing
- (b) Parking
- (c) Tie-down
- (d) Preparing for road transport with special instructions for attaching the wings, fuselage and empennage in the transport vehicle, if appropriate).

8.5 *Cleaning and care*

(Describe cleaning procedures for at least the following aircraft items:

canopy

painted exterior surfaces (especially the leading edge of the wing)

and explain the recommended cleaning agents and give caution notes, if necessary).

(Model Designation or Document No.)

Section 9

- 9. Supplements
- 9.1 Introduction
- 9.2 List of inserted supplements 9.3 Supplements inserted

9.1

(Model Designation or Document No.)**9.1 Introduction**

This Section contains the appropriate supplements necessary to safely and efficiently operate the sailplane when equipped with various optional systems and equipment not provided with the standard sailplane.

9.2 List of inserted supplements

Date of Insertion	Doc. No.	Title of inserted supplement

9.3 Supplements inserted

(Each supplement must normally cover only a single system, device or piece of equipment such as a removable powerplant or an autopilot system. The supplement may be issued by the sailplane manufacturer or by any other manufacturer of the applicable item.

The supplement must be approved by the Agency and must contain all deviations and changes relative to the basic Flight Manual.

Each supplement must be a self-contained, miniature Flight Manual with at least the following:

Section 1, General

The purpose of the Supplement and the system or equipment to which it specifically applies must be stated.

Section 2, Limitations

Any change to the Limitations, markings or placards of the basic Flight Manual must be stated. If there is no change, a statement to that effect must be made.

Section 3, Emergency Procedures

Any addition or change to the basic emergency procedures of the Flight Manual must be stated. If there is no change, a statement to that effect must be made.

Section 4, Normal Procedures

Any addition or change to the basic normal procedures of the Flight Manual must be stated. If there is no change, a statement to that effect must be made.

Section 5, Performance

Any effect of the subject installation upon sailplane performance as shown in the basic Flight Manual must be indicated. If there is no change, a statement to that effect must be made.

Section 6, Weight and balance

Any effect of the subject installation upon weight and balance of the sailplane must be indicated. If there is no change, a statement to that effect must be made)

CS 22.1583 Operating limitations

ED Decision 2003/13/RM

- (a) *Air-speed limitations.* The following information must be furnished:
- (1) Information necessary for the marking of the air-speed limits on the indicator as required in [CS 22.1545](#), and the significance of each of those limits and of the colour coding used on the indicator. (See [AMC 22.1583\(a\)](#))
 - (2) The speeds V_A , V_{LO} , V_T , V_W and, where appropriate, $V_{PO\ min}$, $V_{PO\ max}$ and V_{PE} and their significance.
- (b) *Weights.* The following information must be furnished:
- (1) the maximum weight and the maximum weight of non-lifting parts. If the sailplane is equipped for expendable waterballast, the maximum weight with and without waterballast must be furnished.
 - (2) Any other weight limit, if necessary.
- (c) *Centre of gravity.* The established c.g. limits required by [CS 22.23](#) must be furnished.
- (d) *Manoeuvres.* Authorised manoeuvres established in accordance with [CS 22.3\(a\)](#) or [CS 22.3\(b\)](#), as appropriate, together with permissible ranges of wing-flap position must be stipulated.
- (e) *Flight load factors.* Manoeuvring load factors; the following must be furnished:
- (1) The factors corresponding to point A and point G of Figure 1 of [CS 22.333\(b\)](#), stated to be applicable at V_A ;
 - (2) The factors corresponding to point D and point E of Figure 1, of [CS 22.333\(b\)](#), stated to be applicable at V_{NE} .
 - (3) The factor with airbrakes extended as specified in [CS 22.345](#).
 - (4) The factor with wing-flaps extended as specified in [CS 22.345](#).
 - (5) Markings in accordance with [CS 22.1548](#).
- (f) *Kinds of operation.* The kinds of operation (such as VFR, cloud-flying, day-ornight operation) in which the sailplane may be used, must be stated. The minimum equipment required for the respective kind of operation must be listed.
- (g) *Aerotow, auto-tow and winchlaunching.* The following information on aerotowing, autotowing and winch-launching must be stated:
- (1) the maximum permissible nominal strength for the towing cable or weak link;
 - (2) the minimum towing cable length established in accordance with [CS 22.151\(d\)](#).
 - (3) Only textile ropes must be used for aerotowing.
- (h) *Powerplant limitations.* The following information must be furnished:
- (1) Limitations required by [CS 22.1521](#).
 - (2) Information necessary for marking the instruments required by [CS 22.1549](#) through [CS 22.1553](#).
- (i) *Placards.* Placards required by [CS 22.1555](#) through 22.1559 must be presented.
- (j) In the case of the two seat sailplane the single pilot seat location and the limitations for solo flight must be furnished as determined under [CS 22.1523](#).

- (k) Any limitation associated with the carriage of water ballast necessary for safe operation must be furnished.

AMC 22.1583(a) Operating limitations

ED Decision 2003/13/RM

For the purpose of explaining the significance of V_{RA} , all air movements in lee-wave rotors, thunderclouds, visible whirlwinds, or over mountain crests, are to be understood as rough air.

CS 22.1585 Operating data and procedures

ED Decision 2003/13/RM

Information concerning normal and emergency procedures and other pertinent information necessary for safe operation must be furnished, including:

- (a) The stall speed in the various configurations.
- (b) Any loss of altitude more than 30 m or any pitch attitude more than 30° below the horizon occurring during the recovery part of the manoeuvre prescribed in [CS 22.201](#).
- (c) Any loss of altitude of more than 30 m occurring in the recovery part of the manoeuvre prescribed in [CS 22.203](#).
- (d) Spinning characteristics, including loss of altitude, any tendency for the spin to turn into a spiral dive, and recommended recovery procedure.
- (e) Recommended operational speeds and entry speeds for each authorised manoeuvre.
- (f) Slip characteristics in landing configuration, with airbrakes extended.
- (g) any special procedures or advice to the pilot that may be necessary for aerotowing, wire or bungee launching
- (h) The take-off distances in the conditions of [CS 22.51](#), unless classified as a SelfSustaining Powered Sailplane, in which case there must be a statement in limitations section of the Flight Manual that the sailplane is not approved for take-off by sole means of its own power. In addition the statement must make clear which configurations are approved for launching.
- (i) Special procedures to start the engine in flight, if necessary. The maximum demonstrated engine start density altitude, after a prolonged in flight shutdown, and the normal height loss to be expected during extension/unfeathering restart, and the achievement of minimum climb power, must be stated.
- (j) For Self-Sustaining Powered Sailplanes, the maximum altitude that can be sustained.
- (k) Information on the total quantity of usable fuel.
- (l) Special preflight procedures to ensure safe operation of engine and accessories, if necessary.
- (m) Advice to the pilot for correct adjustment and positioning of an adjustable headrest, if installed.
- (n) Information on the use of water ballast.

AMC 22.1585(f) Operating data and procedures

ED Decision 2003/13/RM

Slip characteristic description should include:

- (1) qualitative effectiveness of the manoeuvre;
- (2) speed range above the recommended approach speed (see [CS 22.1545\(e\)](#)) within which the manoeuvre can be safely performed;
- (3) the appropriate pilot action in response to a control force decrease or reversal;
- (4) degradation, if any, in the airspeed system accuracy during the slip; and
- (5) the effect of a partial water-ballast.

CS 22.1587 Performance information

ED Decision 2003/13/RM

The following information must be furnished:

- (a) Airspeed system calibration.
- (b) The demonstrated crosswind velocity.
- (c) Take-off performance versus density altitude and the influence of other than smooth and hard surfaces.

CS 22.1589 Loading information

ED Decision 2003/13/RM

The following loading information must be furnished:

- (a) The empty weight and the position of the empty weight c.g.
- (b) Instruction enabling the pilot of the sailplane to determine the water ballast load versus the useful load.

SUBPART H — ENGINES

GENERAL

CS 22.1801 Applicability

ED Decision 2003/13/RM

This Subpart H is applicable to spark-and compression-ignition engines for powered sailplanes.

AMC 22.1801 Applicability

ED Decision 2003/13/RM

- (a) When spark ignition is provided a single ignition system is acceptable.
- (b) Engines certificated under CS-E are accepted as complying with this Subpart H.

CS 22.1805 Instruction manual

ED Decision 2003/13/RM

An instruction manual containing the information that the applicant considers essential for installing, operating, servicing and maintaining the engine must be provided.

CS 22.1807 Engine ratings and operating limitations

ED Decision 2003/13/RM

Engine ratings and operating limitations to be established are based on the operating conditions demonstrated during the bench tests prescribed in this Subpart H. They include power ratings and operational limitations relating to speeds, temperatures, pressures, fuels and oils which the applicant finds necessary for the safe operation of the engine.

CS 22.1808 Selection of engine power ratings

ED Decision 2003/13/RM

Each selected rating must be for the lowest power that all engines of the same type may be expected to produce under the conditions to determine that rating.

DESIGN AND CONSTRUCTION

CS 22.1815 Materials

ED Decision 2003/13/RM

The suitability and durability of materials used in the engine must –

- (a) Be established on the basis of experience or tests; and
- (b) Conform to approved specifications that ensure their having the strength and other properties assumed in the design data.

CS 22.1817 Fire prevention

ED Decision 2003/13/RM

- (a) The design and construction of the engine and the materials used must minimise the probability of the occurrence and spread of fire because of structural failure, overheating or other causes.
- (b) Each external line or fitting that conveys flammable fluids must be at least fire resistant. Components must be shielded or located to safeguard against the ignition of leaking flammable fluid.

CS 22.1819 Durability

ED Decision 2003/13/RM

Engine design and construction must minimise the probability of occurrence of an unsafe condition of the engine between overhauls.

CS 22.1821 Engine cooling

ED Decision 2003/13/RM

Engine design and construction must provide the necessary cooling under conditions in which the powered sailplane is expected to operate.

CS 22.1823 Engine mounting attachments and structure

ED Decision 2003/13/RM

- (a) The maximum allowable loads for engine mounting attachments and related structure must be specified.
- (b) The engine mounting attachments and related structure must be able to withstand the specified loads without failure, malfunction or permanent deformation.

AMC 22.1823(a) Engine mounting attachments and structure

ED Decision 2003/13/RM

The maximum allowable loads should take account of the flight and ground loads and the emergency alighting loads specified in CS-22 for the sailplane as a whole.

CS 22.1825 Accessory attachment

ED Decision 2003/13/RM

Each accessory drive and mounting attachment must be designed and constructed so that the engine will operate properly with the accessories attached. The design of the engine must allow the examination, adjustment or removal of each essential engine accessory.

CS 22.1833 Vibration

ED Decision 2003/13/RM

The engine must be designed and constructed to function throughout its normal operating range of crankshaft rotational speeds and engine powers without inducing excessive stress in any of the engine parts because of vibration and without imparting excessive vibration forces to the structure of the powered sailplane.

CS 22.1835 Fuel and induction system

ED Decision 2003/13/RM

- (a) The fuel system of the engine must be designed and constructed to supply the appropriate mixture of fuel to the combustion chambers throughout the complete operating range of the engine under all starting, flight and atmospheric conditions.
- (b) The intake passages of the engine through which air, or fuel in combination with air, passes must be designed and constructed to minimise ice accretion and vapour condensation in those passages. The engine must be designed and constructed to permit the use of a means for ice prevention.
- (c) The type and degree of fuel filtering necessary for protection of the engine fuel system against foreign particles in the fuel must be specified. The applicant must show (e.g. within the 50-hour run prescribed in [CS 22.1849\(a\)](#)) that foreign particles passing through the prescribed filtering means will not critically impair engine fuel system functioning.
- (d) Each passage in the induction system that conducts a mixture of fuel and air, and in which fuel may accumulate, must be self-draining to prevent a liquid lock in the combustion chambers. This applies to all attitudes that the applicant establishes as those the engine can have when the powered sailplane in which it is installed is in the static ground attitude.

CS 22.1839 Lubrication system (four-stroke engines only)

ED Decision 2003/13/RM

- (a) The lubrication system of the engine must be designed and constructed so that it will function properly in all attitudes and atmospheric conditions in which the powered sailplane is expected to operate. In wet-sump engines this requirement must be met when the engine contains only the minimum oil quantity, the minimum quantity being not more than half the maximum quantity.
- (b) The lubrication system of the engine must be designed and constructed to allow installing a means of cooling the lubricant.
- (c) The crankcase must be vented to preclude leakage of oil from excessive pressure in the crankcase.

BENCH TESTS

CS 22.1843 Vibration test

ED Decision 2003/13/RM

Except where the engine is of a type of construction known not to be prone to hazardous vibration, the engine must undergo a vibration survey to establish crankshaft torsional and bending characteristics over a range of rotational speeds from idling to 110% of the maximum continuous speed or 103% of the maximum desired take-off speed, whichever is the greater. The survey must be conducted with a representative propeller. No hazardous condition may be present.

AMC 22.1843 Vibration test

ED Decision 2003/13/RM

The propeller should be so chosen that the prescribed maximum rotational speed is obtained at full throttle or at the desired maximum permissible manifold pressure, whichever is appropriate.

CS 22.1845 Calibration test

ED Decision 2003/13/RM

Each engine must be subjected to the calibration tests necessary to establish its power characteristics and the conditions for the endurance test specified in [CS 22.1849\(a\) to \(c\)](#). The results of the power characteristics calibration tests form the basis for establishing the characteristics of the engine over its entire operating range of crankshaft rotational speeds, manifold pressures, and fuel/air mixture settings. Power ratings are based on standard atmospheric conditions at sea-level.

CS 22.1847 Detonation test (spark ignition only)

ED Decision 2003/13/RM

The engine must be tested to establish that it can function without detonation throughout the range of intended conditions of operation.

CS 22.1849 Endurance test

ED Decision 2003/13/RM

- (a) The engine must be subjected to an endurance test (with a representative propeller) that includes a total of 50 hours of operation and consists of the cycles specified in [CS 22.1849\(c\)](#).
- (b) Additional endurance testing at particular rotational speed(s) may be required depending on the results of the tests prescribed in [CS 22.1843](#), to establish the ability of the engine to operate without fatigue failure.
- (c) Each cycle must be conducted as follows:

Sequence	Duration (Minutes)	Operating Conditions
1	5	Starting – Idle
2	5	Take-off power
3	5	Cooling run (Idle)
4	5	Take-off power
5	5	Cooling run (Idle)
6	5	Take-off power

Sequence	Duration (Minutes)	Operating Conditions
7	5	Cooling run (Idle)
8	15	75% of maximum continuous power
9	5	Cooling run (Idle)
10	60	Maximum continuous power
11	5	Cooling run and stop
Total:	120	

- (d) During or following the endurance test the fuel and oil consumption must be determined.

CS 22.1851 Operation test

ED Decision 2003/13/RM

The operation test must include the demonstration of backfire characteristics, starting, idling, acceleration, overspeeding and any other operational characteristics of the engine.

CS 22.1853 Engine component test

ED Decision 2003/13/RM

- (a) For engine components that cannot be adequately substantiated by endurance testing in accordance with [CS 22.1849\(a\) to \(c\)](#), the applicant must conduct additional tests to establish that components are able to function reliably in all normally anticipated flight and atmospheric conditions.
- (b) Temperature limits must be established for each component that requires temperature controlling provisions to ensure satisfactory functioning, reliability and durability.

CS 22.1855 Teardown inspection

ED Decision 2003/13/RM

After the endurance test has been completed the engine must be completely dis-assembled. No essential component may show rupture, cracks or excessive wear.

CS 22.1857 Engine adjustment and parts replacement

ED Decision 2003/13/RM

Service and minor repairs to the engine may be made during the bench tests. If major repairs or replacements of parts is necessary during the tests or after the teardown inspection, or if essential parts have to be replaced, the engine must be subjected to any additional tests the Agency may require.

SUBPART J — PROPELLERS

GENERAL

CS 22.1901 Applicability

ED Decision 2003/13/RM

This Subpart J is applicable to propellers for powered sailplanes.

AMC 22.1901 Applicability

ED Decision 2003/13/RM

Propellers certificated under CS-P are accepted as complying with Subpart J.

CS 22.1903 Instruction manual

ED Decision 2003/13/RM

An instruction manual containing the information considered essential for installing, servicing and maintaining the propeller must be provided.

CS 22.1905 Propeller operating limitations

ED Decision 2003/13/RM

Propeller operating limitations must be established on the basis of the conditions demonstrated during the tests specified in this Subpart J.

DESIGN AND CONSTRUCTION

CS 22.1917 Materials

ED Decision 2003/13/RM

The suitability and durability of materials used in the propeller must –

- (a) Be established on the basis of experience or tests; and
- (b) Conform to approved specifications that ensure their having the strength and other properties assumed in the design data.

CS 22.1919 Durability

ED Decision 2003/13/RM

Propeller design and construction must minimise the possibility of the occurrence of an unsafe condition of the propeller between overhauls.

CS 22.1923 Pitch Control

ED Decision 2003/13/RM

- (a) Failure of the propeller pitch control may not cause hazardous overspeeding under intended operation conditions.
- (b) If the propeller can be feathered the control system must be designed to minimize
 - (1) consequential hazards, such as a propeller runaway resulting from malfunction or failure of the control system
 - (2) the possibility of an unintentional operation.

TESTS AND INSPECTIONS

CS 22.1933 General

ED Decision 2003/13/RM

It must be shown that the propeller and its main accessories complete the tests and inspections prescribed in [CS 22.1935](#) through [CS 22.1947](#) without evidence of failure or malfunction.

CS 22.1935 Blade retention test

ED Decision 2003/13/RM

The hub and blade retention arrangement of propellers with detachable blades must be subjected to a load equal to twice the centrifugal force occurring at the maximum rotational speed (other than transient overspeed) for which approval is sought, or the maximum governed rotational speed, as appropriate. This may be done either by a whirl test or a static pull test.

CS 22.1937 Vibration load limit test

ED Decision 2003/13/RM

The vibration load limits of each metal hub and blade, and of each primary load-carrying metal component of non-metallic blades, must be determined for all reasonably foreseeable vibration load patterns.

CS 22.1939 Endurance test

ED Decision 2003/13/RM

- (a) *Fixed-pitch or ground-adjustable wood or metal propellers.* Fixed-pitch or ground-adjustable wood or metal propellers must be subjected to one of the following tests:
- (1) A 50-hour flight test in level flight or in climb. At least five hours of this flight test must be with the propeller at the rated rotational speed and the remainder of the 50 hours must be with the propeller operated at not less than 90% of the rated rotational speed. This test must be conducted on a propeller of the greatest diameter for which certification is requested.
 - (2) A 50-hour endurance bench test on an engine at the power and propeller rotational speed for which certification is sought. This test must be conducted on a propeller of the greatest diameter for which certification is requested.
- (b) *Variable pitch propellers.* Wood or metal variable pitch propellers (propellers the pitch of which can be changed by the pilot or by automatic means while the propeller is rotating) must be subjected to one of the following tests:
- (1) A 50-hour test on an engine with the same power and rotational speed characteristics as the engine or engines with which the propeller is to be used. Each test must be made at the maximum continuous rotational speed and power rating of the propeller. If a take-off performance greater than the maximum continuous rating is to be established, an additional 10-hour bench test must be made at the maximum power and rotational speed for the take-off rating.
 - (2) Operation of the propeller throughout the engine endurance tests prescribed in Subpart H.

CS 22.1941 Functional tests

ED Decision 2003/13/RM

- (a) Each variable pitch propeller must be subjected to all applicable functional tests of this paragraph. The same propeller used in the endurance test must be used in the functional test and must be driven by an engine on a test stand or on a powered sailplane.
- (b) *Manually controllable propellers.* 500 complete cycles of control throughout the pitch and rotational speed ranges, excluding the feathering range.
- (c) *Automatically controllable propellers.* 1500 complete cycles of control throughout the pitch and rotational speed ranges, excluding the feathering range.

CS 22.1945 Teardown inspection

ED Decision 2003/13/RM

After the endurance test has been completed the propeller must be completely dis-assembled. No essential component may show rupture, cracks or excessive wear.

CS 22.1947 Propeller adjustments and parts replacement

ED Decision 2003/13/RM

The applicant may service and make minor repairs to the propeller during the tests. If major repairs or replacement of parts is found necessary during the tests or in the teardown inspection, any additional tests that the certificating Agency finds necessary must be conducted.